

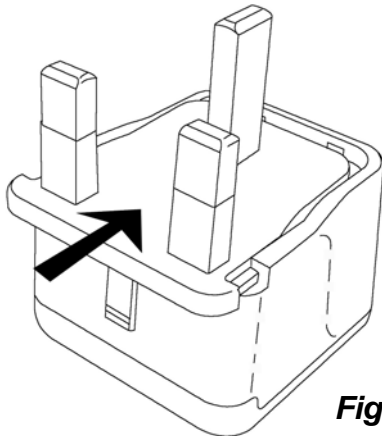

# Mains Plug Travel Adapter

1. Slide the plug-insert all the way into the master unit (**Figure 1**)
2. Move the sliding lock button into the LOCK position (**Figure 2**)



**Figure 1**

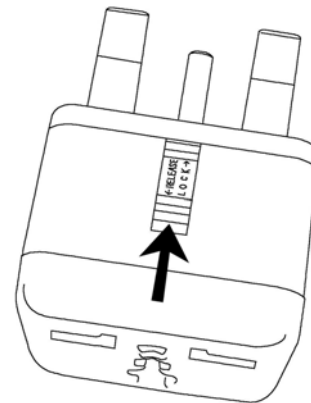

**Figure 2**

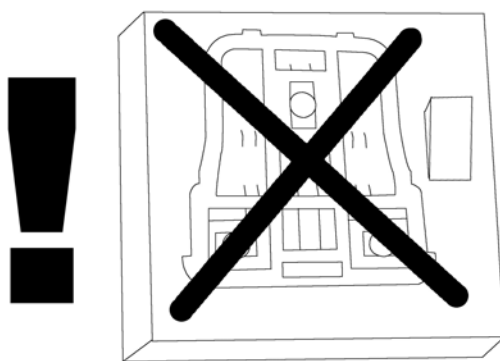

**NEVER** separately plug a plug-insert into a mains socket!

Always check that the plug-insert is correctly locked into the master unit.

**IMPORTANT:** This adapter is designed to change the shape of the plug only. It **DOES NOT** change the voltage! Before use, please ensure your electrical equipment complies with the voltage of the country you are in.

For temporary travel use only; not for permanent use!

**Keep out of reach of children!**

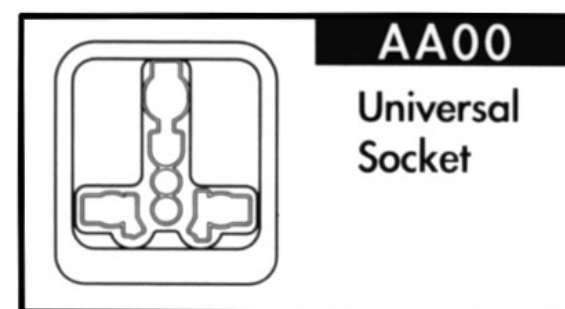
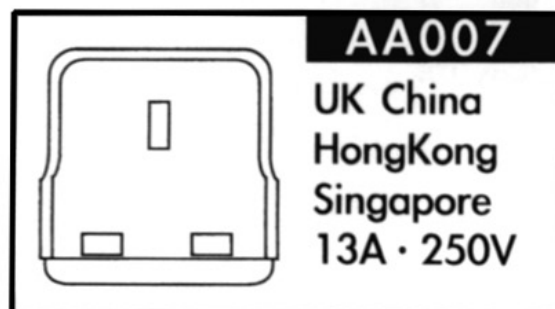
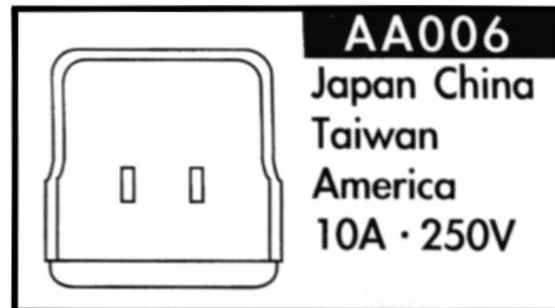
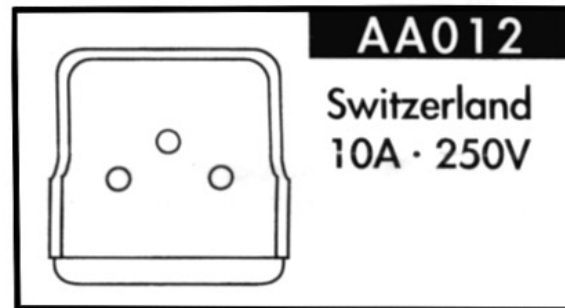
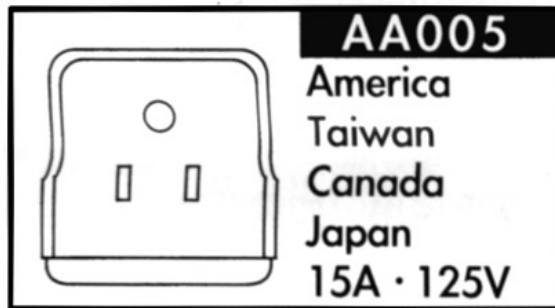
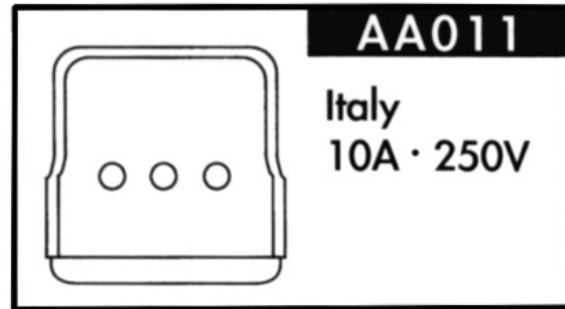
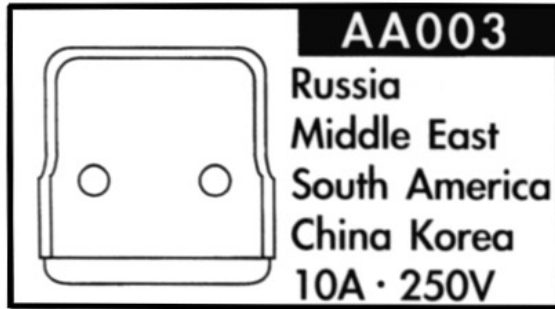
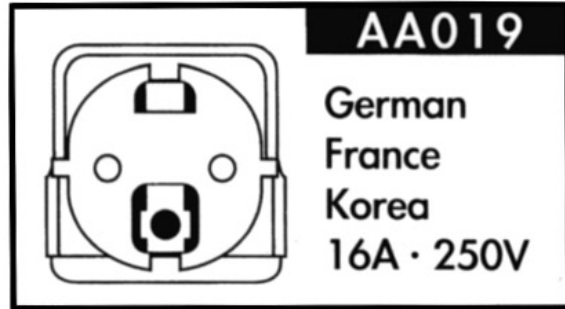
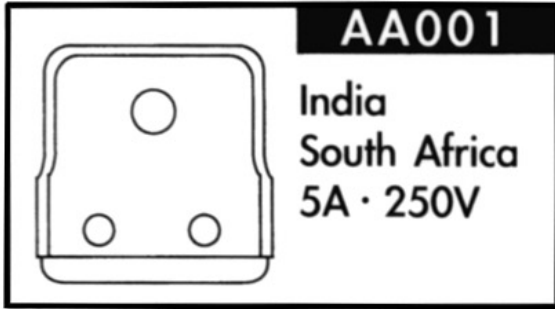

No. 73013

April 2006

[www.lindy.com](http://www.lindy.com)

## Free Manuals Download Website

<http://myh66.com>

<http://usermanuals.us>

<http://www.somanuals.com>

<http://www.4manuals.cc>

<http://www.manual-lib.com>

<http://www.404manual.com>

<http://www.luxmanual.com>

<http://aubethermostatmanual.com>

Golf course search by state

<http://golfingnear.com>

Email search by domain

<http://emailbydomain.com>

Auto manuals search

<http://auto.somanuals.com>

TV manuals search

<http://tv.somanuals.com>