

LINDY®

COMPUTER CONNECTION TECHNOLOGY

GigaPatchPanel

Manual
Benutzerhandbuch
Manuel
Manuale Uso

English
Deutsch
Français
Italiano



LINDY Art.No. 20703

LINDY Art.No. 20704



www.LINDY.com

© LINDY ELECTRONICS LIMITED & LINDY-ELEKTRONIK GMBH - FIRST EDITION (Jul 2001)



English Manual

LINDY GigapatchPanel

The LINDY GigaPatchPanel is supplied with 16 or 24 Cat 6 ports. The new modular construction allows you to install the panels with any even number of ports between 2 and 24, partially equipped panels can be extended or completed with the addition of dual modules at any time. This means that the valuable space inside your rack can be fully optimised, for the future expansion of your network.

The newly developed LSA-rct technology allows a fast and reliable connection of the wires to the terminals. Each unit is supplied with a suitable crimping tool, however there is also a premium tool available which allows you to connect 4 wires simultaneously and thus helps to increase efficiency and lower the costs of the network installation.

- ✍ Up to 12 shielded dual RJ45 Cat 6 modules per unit
- ✍ PCB-terminals optimised for fast data transfer
- ✍ Strain relief's are attached - so they won't get lost
- ✍ Additional strain relief by use of a cable tie is possible
- ✍ Coding scheme both, EIA/TIA 568 A and B
- ✍ Crimping tool supplied
- ✍ Connection via LSA-rct terminals
- ✍ Cores with 22-24 AWG can be accommodated
- ✍ Pairs can be lead directly to the terminals – no need to untwist them

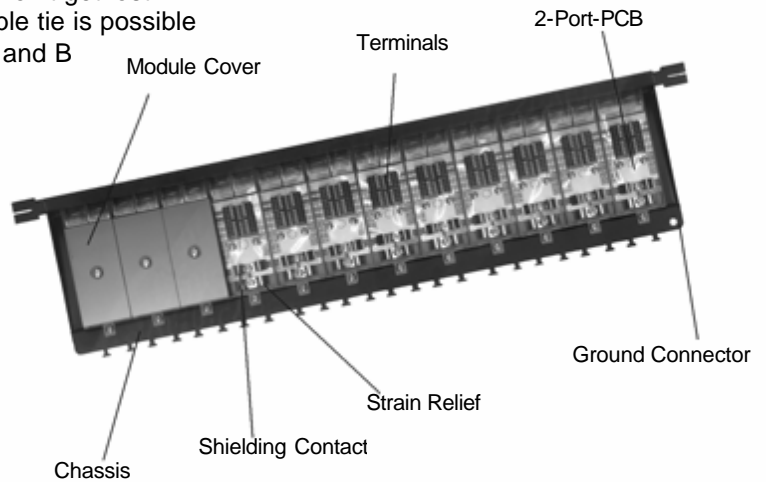

Preparation of the cable

Foil- or Braid shielded cable

Cut away the outer sheath by approx 65mm with a cable or sharp knife. Make sure to cut only as deep as the shielding allows, don't damage the insulation of the wires!

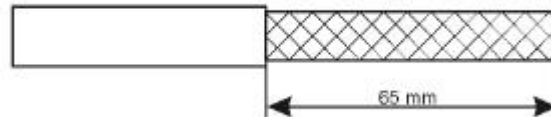

Cut the foil or the braid shielding as shown in the picture so that you leave approx 10mm of the shielding. Wind the shielding wire around the 10mm left of the shielding, it will be clamped later beneath the strain relief.

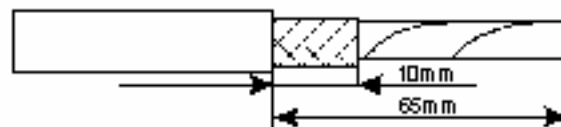

If present, shorten the shielding foil of the single pairs (Pimf-cable only) to the same length. Untwist the pairs for 13mm at most and connect the wires using the following colour scheme

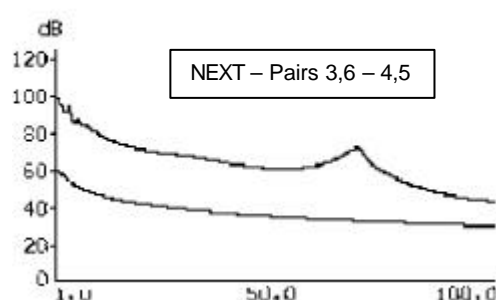
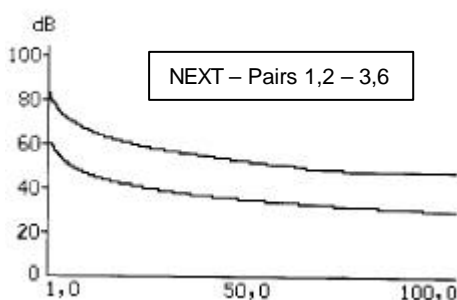
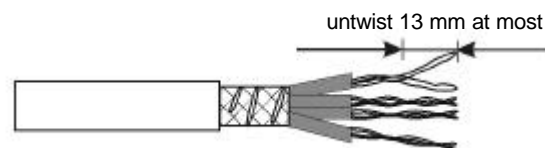

English Manual

Mounting

1. Mount the strain relief and the shielding braid or foil as shown in the picture. The flexible strain reliefs will avoid squeezing the solid core cables too heavily.

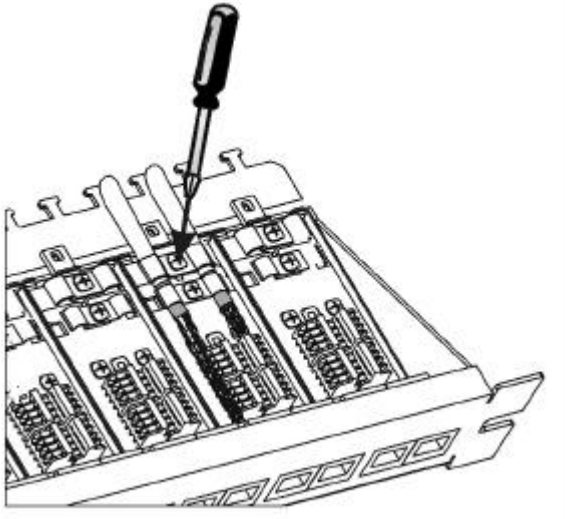

2. Connect the individual wires

Note: The colour schemes TIA 568-A and TIA 568-B must not be mixed within one network structure

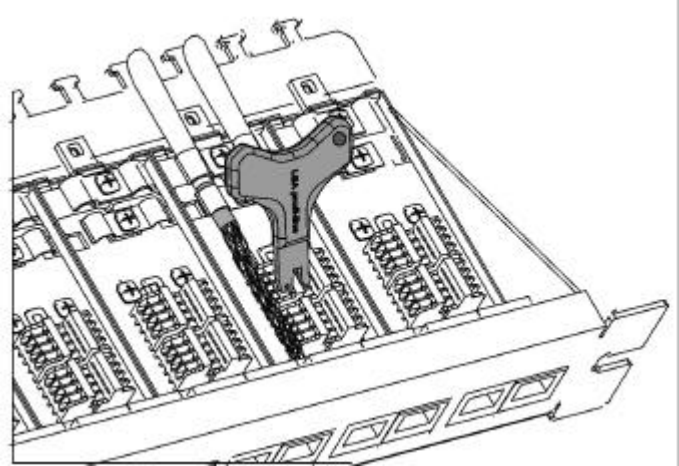

3. Snap in the cover

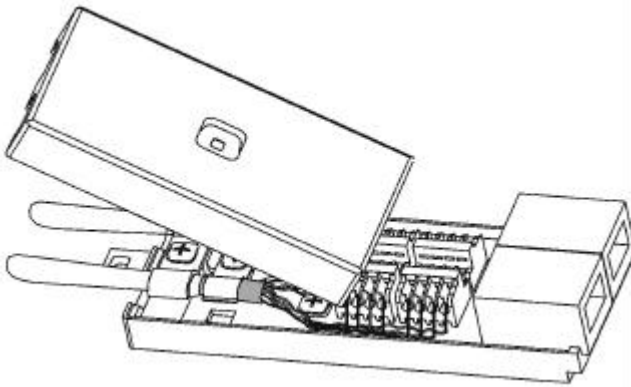

4. Mount the cover screw

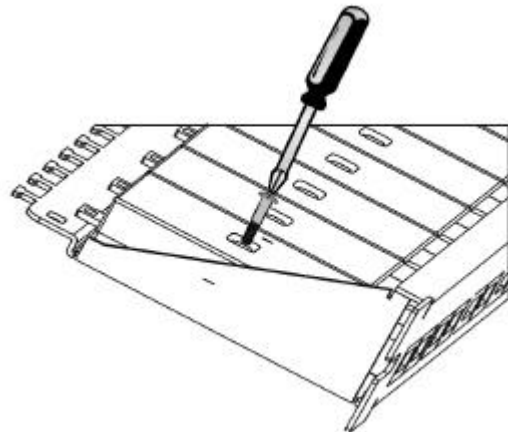

Pinout of a module confirming ISO/IEC 11081

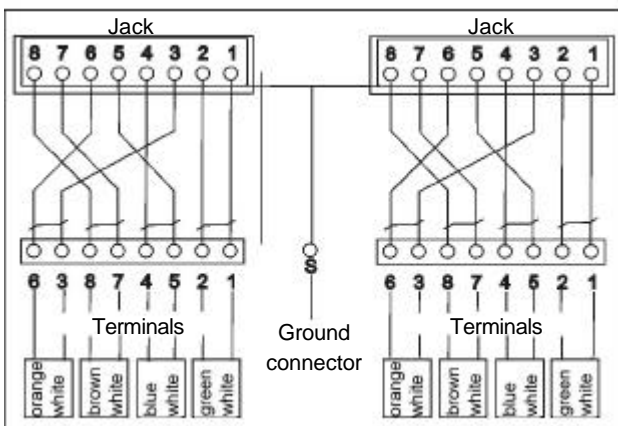

Colour scheme for 100Base-T and 1000BaseT

Jack Pin #	Wire colour EIA/TIA 568A	Wire colour EIA/TIA 568B
1	green/white	orange/white
2	green	orange
3	orange/white	green/white
4	blue	blue
5	blue/white	blue/white
6	orange	green
7	brown/white	brown/white
8	brown	brown

Deutsches Benutzerhandbuch

LINDY GigaPatchPanel

Die LINDY GigaPatchPanels sind standardmäßig mit 16 oder 24 Cat.6-Ports bestückt. Durch das neuartige modulare Konzept können Panels mit jeder geraden Anzahl Ports zwischen 2 und 24 bestückt, und anteilig bestückte Panels jederzeit mit den Einzelmodulen nachgerüstet werden. Der wertvolle Platz im Server-Rack läßt sich somit zukunftsorientiert und offen für künftige Erweiterungen planen. Durch die neu entwickelte LSA-rct-Technologie lassen sich die Panels schnell und problemlos beschalten. Jedem Panel liegt ein Anlegewerkzeug bei, wahlweise kann jedoch auch die Premiumversion (LINDY Art. Nr. 20708) verwendet werden, die ein Anlegen von simultan vier Drähten gestattet. Die Beschaltung der Panels gestaltet sich dadurch noch effizienter und hilft so, die Installationskosten niedrig zu halten.

- ✗ bis zu 12 einzeln abgeschirmte Module zu je 2 RJ45-Cat 6-Anschlüssen
- ✗ Optimierte Leiterplatten-Anschlussklemmen für schnelle Datenübertragung
- ✗ Zugentlastung mittels 'unverlierbarer' Kabelschellen
- ✗ zusätzliche Zugentlastung mittels Kabelbinder möglich
- ✗ Übersichtliche Farbcodierung nach EIA/TIA 568 A/B
- ✗ Anlegewerkzeug im Lieferumfang
- ✗ Beschaltung nach ISO/IEC 11801 /EN 50173
- ✗ Anschluss mittels LSA-Schneidklemmen
- ✗ Beschaltung mit Drähten AWG 22-24
- ✗ Adernpaare können bis zur Klemme geführt werden, ohne daß die Verdrillung gelöst werden muss

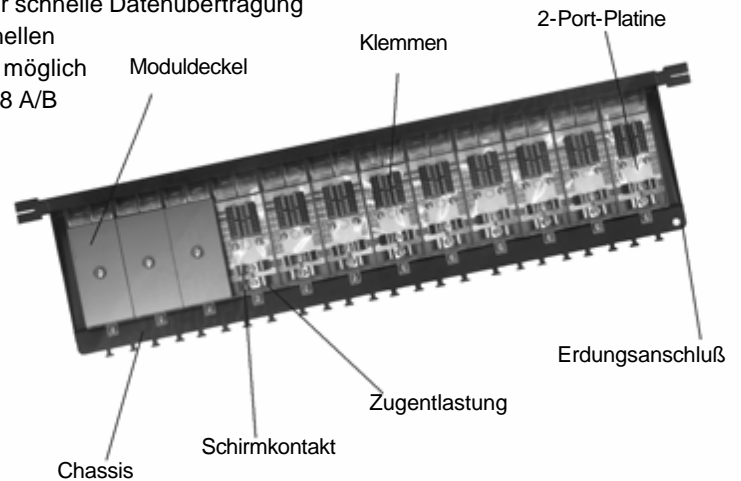

Die Kabelvorbereitung

Kabel mit Geflecht- oder Folienschirm

Setzen Sie den Kunststoffmantel ca. 65mm mit einem Kabel- oder Teppichmesser ab. Achten Sie darauf, nur bis zur Schirmung zu schneiden, damit die Adern nicht verletzt werden.

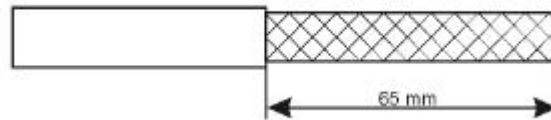

Schneiden Sie das Schirmgeflecht, bzw. Schirm- und Kunststoffolie so ab, dass noch ca. 10 mm unter dem Kunststoffmantel hervorschauen. Wickeln Sie den Beilaufdraht um die verbleibenden 10mm Schirmung, er wird später unter der Schelle mit festgeklemt

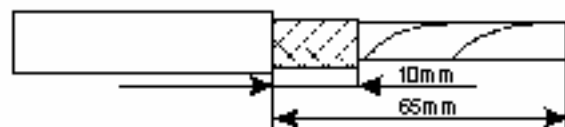

Falls vorhanden, kürzen Sie die Schirmfolie der einzelnen Paare (PiMF-Kabel) auf die gleiche Länge. Entdrillen Sie die Paare maximal auf eine Länge von 13mm und legen Sie die Adern nach dem vorgegebenen Farbschema auf. Verwenden Sie in Ihrem Netzwerk stets nur eines der beiden angegebenen Farbschemata. Niemals mischen!!!

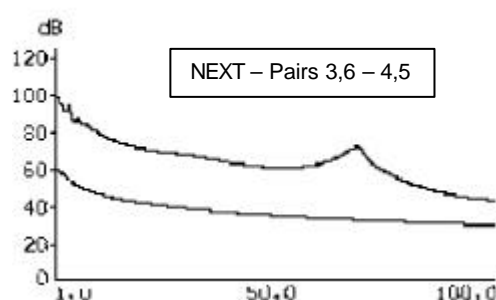
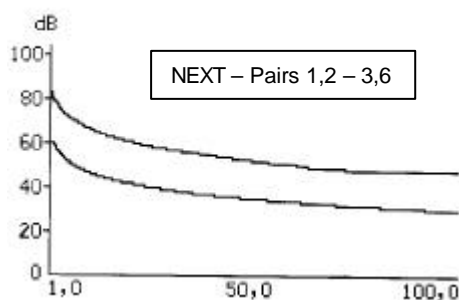
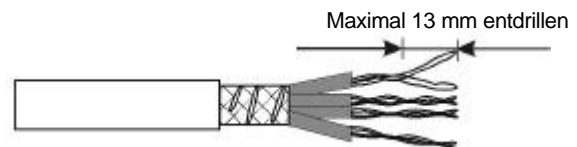

Deutsches Benutzerhandbuch

Montage

5. Befestigen Sie die Kabelzugentlastung und das Schirmgeflecht wie abgebildet. Die flexiblen Kabelschellen vermeiden ein zu starkes Quetschen der Verlegekabel.

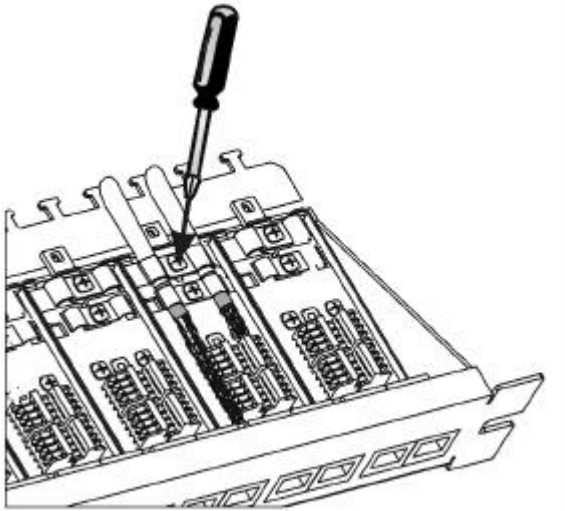

7. Deckel einrasten

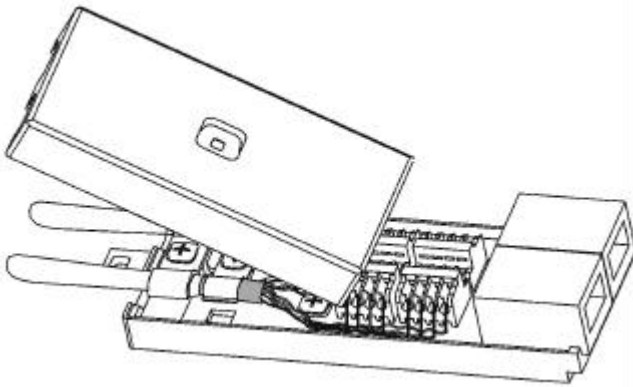

6. Legen Sie die einzelnen Drähte auf

Achtung: Die Farbcodes TIA 568-A und TIA 568-B dürfen innerhalb einer Netzwerkstruktur nicht gemischt werden.

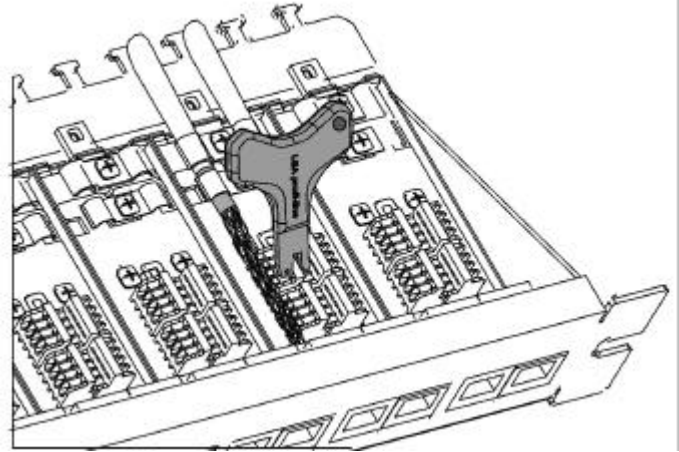

8. Deckel verschrauben

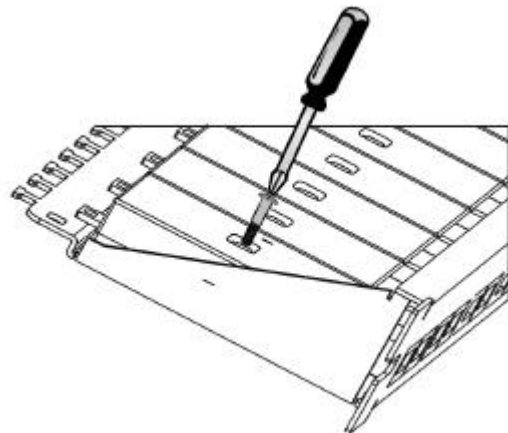

Pinout eines Moduls nach ISO/IEC11801

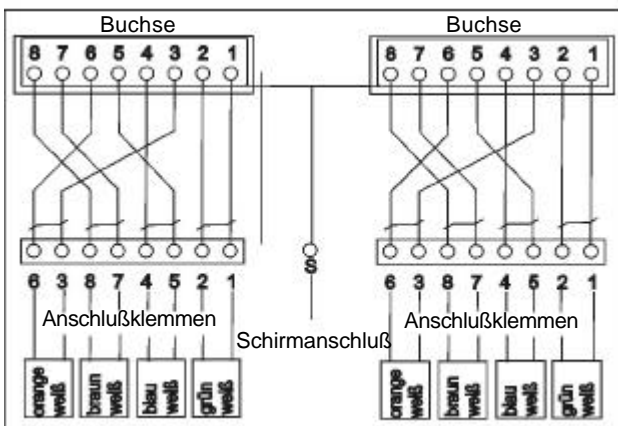

Klemmenbelegung für 100Base-T und 1000Base-T

Patchfeld Anschlußklemme	Adernfarbe nach EIA/TIA 568A	Adernfarbe nach EIA/TIA 568B
1	grün/weiß	orange/weiß
2	grün	orange
3	orange/weiß	grün/weiß
4	blau	blau
5	blau/weiß	blau/weiß
6	orange	grün
7	braun/weiß	braun/weiß
8	braun	braun

Manuel en Français

Panneau de brassage LINDY GigaPatch

Le panneau de brassage LINDY GigaPatch est livré avec 16 ou 24 ports Cat 6. La nouvelle conception modulaire du panneau de brassage vous permet une installation allant de 2 à 24 connexions, les emplacements de ports vides pourront être complétés à tout moment par des modules supplémentaires. Ceci implique des possibilités d'extension pour votre rack même déjà en place.

La nouvelle technologie LSA-rct vous permet une connexion rapide et fiable des fils aux terminaux.

Chaque unité est fournie avec une pince à sertir adaptée, cependant il existe également un outil à sertir de haute qualité vous permettant de connecter 4 fils simultanément, augmentant l'efficacité et baissant les coûts d'installation de votre réseau.

- ✍ Jusqu'à 12 modules doubles blindés RJ45 Cat 6 par unité
- ✍ Terminaux PCB optimisés pour transfert de données rapides
- ✍ Les câbles sont attachés par des serre-câbles – ils ne se perdront pas
- ✍ Possibilité d'ajouter des serre-câbles supplémentaires
- ✍ Schéma de codage EIA/TIA 568 A et B
- ✍ Outil de sertissage fourni
- ✍ Connexions par terminaux LSA-rct
- ✍ Compatible câbles AWG22/24
- ✍ Les paires sont directement connectées aux terminaux – pas besoin de les dénuder

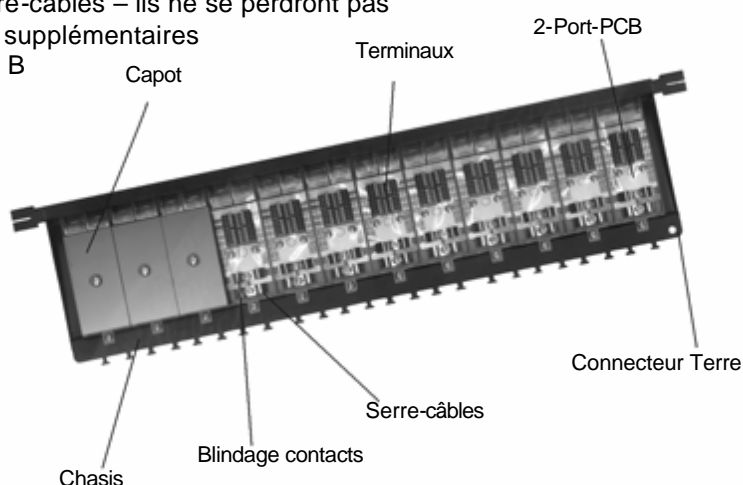

Préparation du câble

Câble blindé torsadé

Coupez la gaine du câble sur approximativement 65mm avec un cutter ou une lame. Soyez certains de couper jusqu'au blindage, n'endommagez pas la gaine des fils intérieurs!

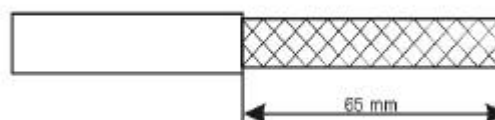

Coupez la feuille d'aluminium ou le blindage comme indiqué sur l'image ci-contre pour laisser approximativement 10mm du blindage. Veuillez laisser dépasser la feuille d'aluminium de 10mm de la gaine, elle sera serrée avec l'aide du serre-câbles.

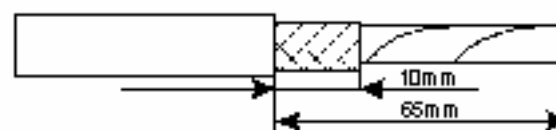

Si présent, raccourcissez le blindage de la paire (câble Pimf uniquement) à la même longueur. Dénudez les paires sur environ 13mm au maximum et connectez-les en utilisant le schéma de codage couleur ci-dessous.

Dénudez 13 mm au maximum

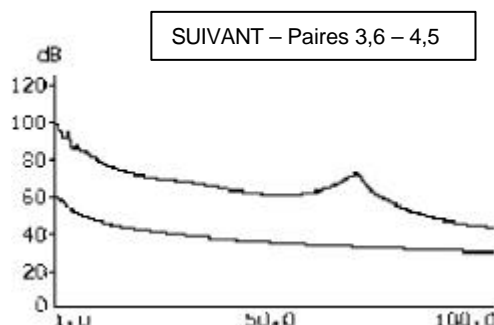
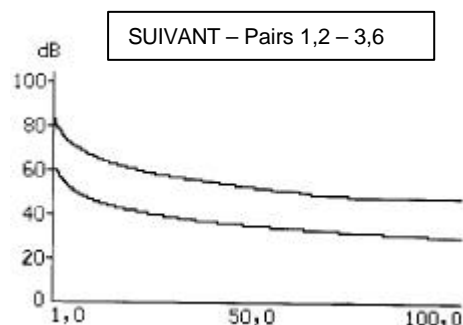
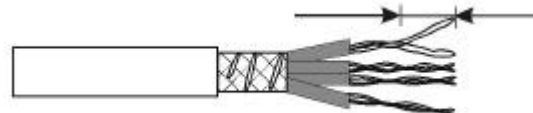

Manuel en Français

Montage

9. Vissez le serre-câbles sur vos câbles.

Le serre-câbles vous évitera une torsion inutile du câble dans la section du connecteur.

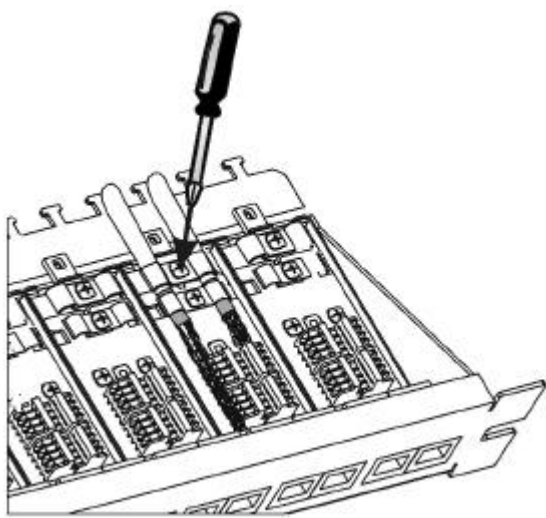

11. Insérez le capot

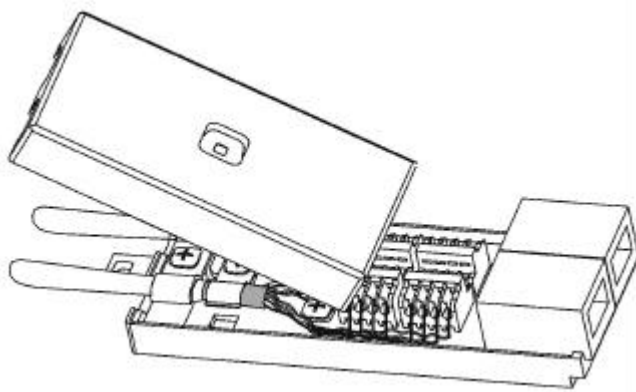

10. Connectez individuellement les fils

Remarque: Les code à couleurs des normes TIA 568-A et TIA 568-B ne doivent pas être mélangés dans une installation réseau.

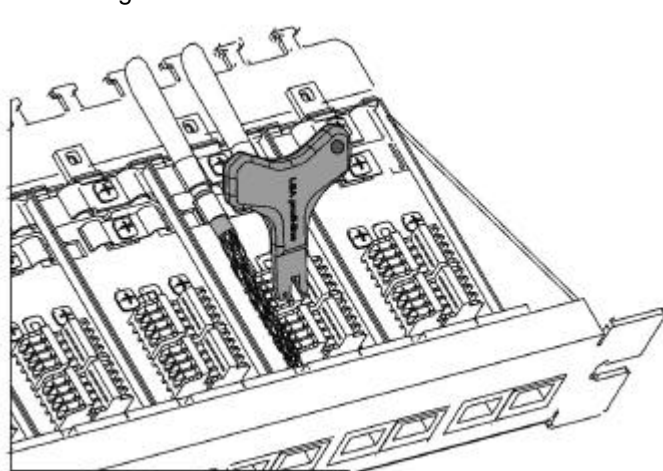

12. Revissez le capot

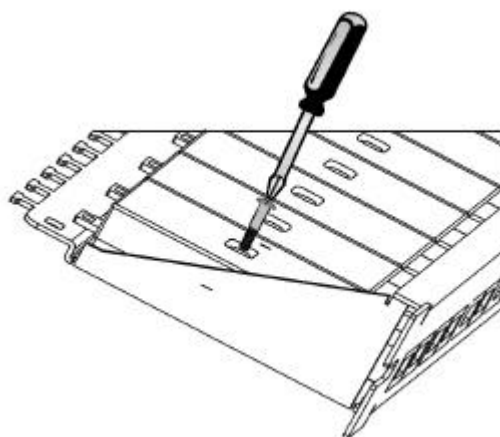

Brochage d'un module ISO/IEC 11081



Schéma des couleurs pour 100Base-T et 1000BaseT

Jack Broche #	Couleur de fil EIA/TIA 568A	Couleur de fil EIA/TIA 568B
1	vert/blanc	orange/blanc
2	vert	orange
3	orange/blanc	vert/blanc
4	bleu	bleu
5	bleu/blanc	bleu/blanc
6	orange	vert
7	brun/blanc	brun/blanc
8	brun	brun

Manuale in Italiano

LINDY GigaPatchPanel

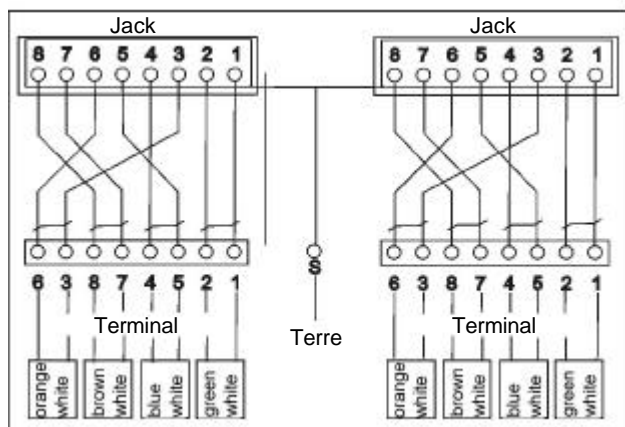
Il LINDY GigaPatchPanel è fornito con 16 o 24 porte Cat.6. La nuova struttura modulare, consente l'installazione di un numero pari di porte, comprese tra 2 e 24. Ciò significa che lo spazio all'interno del mobile rack può essere ottimizzato per eventuali ampliamenti della rete.

La nuova tecnologia LSA-rct consente una veloce ed affidabile connessione dei cavi ai terminali. Ciascuna unità viene fornita con gli appositi attrezzi di montaggio.

- ✍ Fino a 12 moduli RJ45 Cat 6 doppiamente schermati per unità
- ✍ Terminali PCB ottimizzati per il trasferimento veloce dei dati
- ✍ Blocca cavi inclusi
- ✍ Schemi di codifica EIA/TIA 568 A e B
- ✍ Set crimpaggio
- ✍ Connessione via terminali LSA-rct
- ✍ Cavi AWG 22-24 alloggiabili
- ✍ Possibilità di collegare cavi twistati

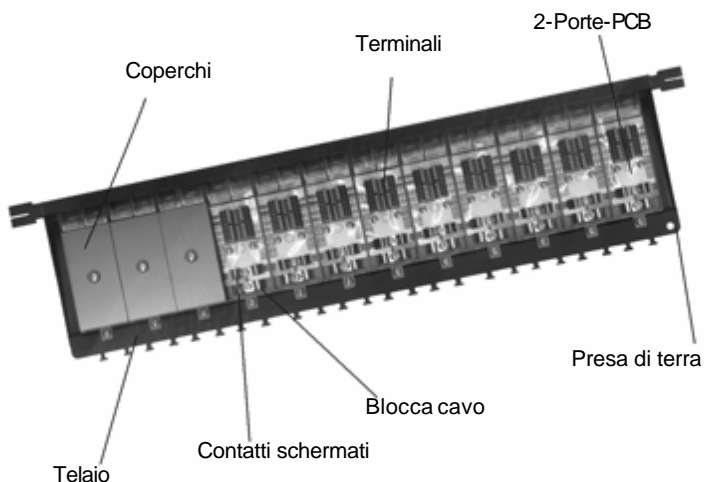

Preparazione del cavo

Tagliare la copertura esterna del cavo per circa 65mm. Attenzione a non danneggiare la parte interna del cavo.

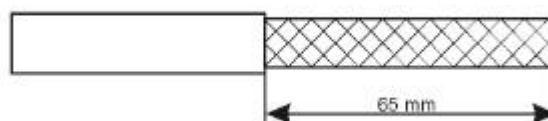

Eliminare la schermatura d'alluminio per circa 55mm dalla fine, lasciandone quindi circa 10 dall'estremità interna.

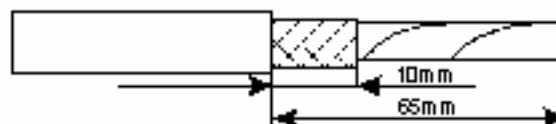

Eliminare l'eventuale schermatura dei singoli cavetti e liberare i singoli cavetti, dalle coppie ritorte per circa 13mm dall'estremità finale.

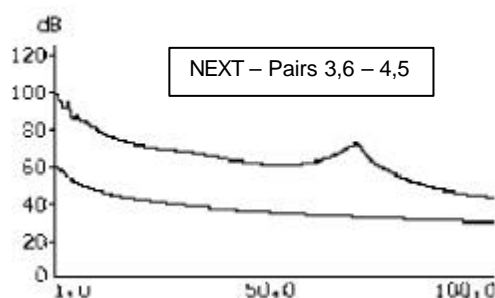
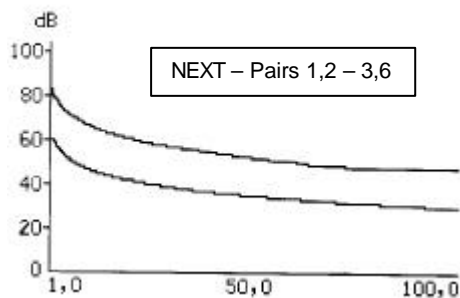
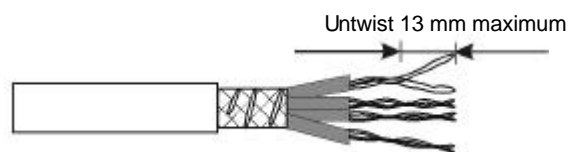

Manuale in Italiano

Montaggio

13. Montare i blocchi cavi come illustrato in figura.

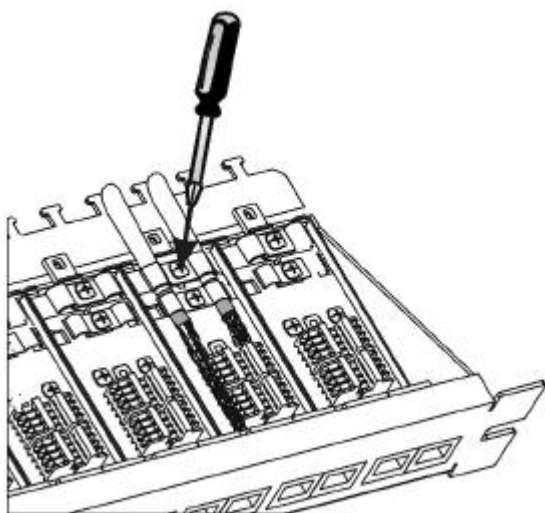

15. Chiudere il coperchio

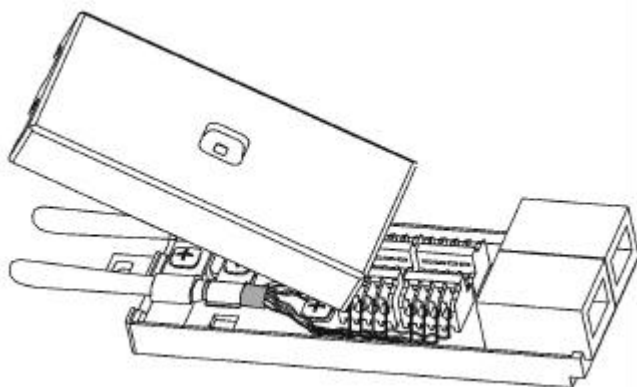

14. Collegare i singoli cavetti.

Nota: Seguire lo schema a colori TIA 568-A e B. Non mischiare schemi e colori all'interno di un singolo sistema network.

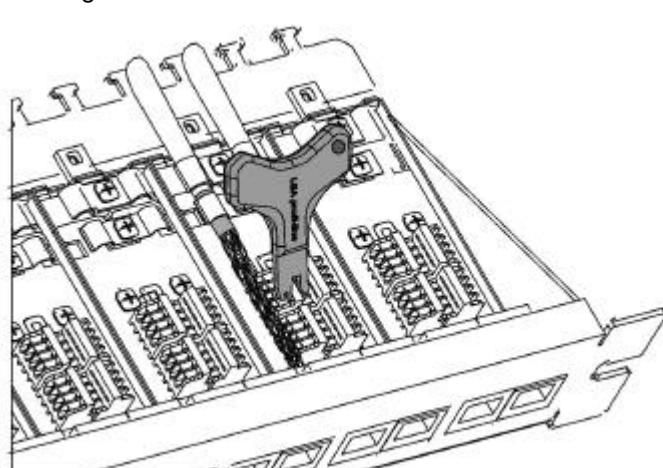

16. Montare le viti

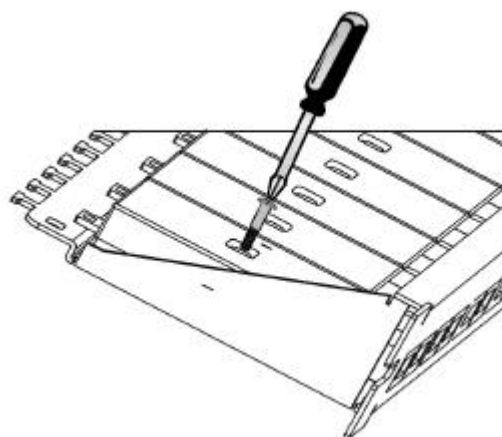

Pinatura conforme a ISO/IEC 11081

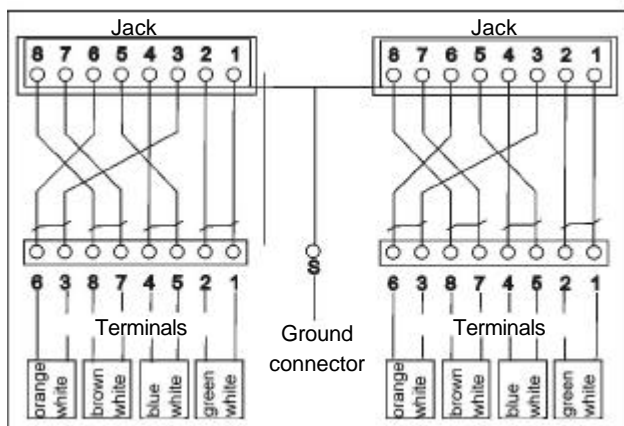

Schema colori per 100Base-T e 1000BaseT

Jack Pin #	Colore cavo EIA/TIA 568A	Colore cavo EIA/TIA 568B
1	verde/bianco	arancio/bianco
2	verde	arancio
3	arancio/bianco	verde/bianco
4	blu	blu
5	blu/bianco	blu/bianco
6	arancio	verde
7	marrone/bianco	marrone/bianco
8	marrone	marrone

Technical Specifications

Number of Ports:	Up to 24 by using up to 12 dual Cat. 6 modules
Wiring:	Confirming ISO / IEC 11801 / EN 50173
Wire Gauge:	Cores of AWG 22 – 24 can be accommodated
Coding Scheme:	Both, EIA/TIA 568 A and B
Terminals:	LSA –rct (rapid contact technology)
Ports:	Data ports up to Cat. 6 can be established One module can be opened for maintenance or without influencing all the other modules, on which network traffic is still running.
Maintenance:	
Strain reliefs:	Attached strain reliefs – no way for them to get lost
Additional Strain Relief:	Optional with a cable tie
Crimping tool:	Supplied with every unit
PCB:	Optimised for fast data transfer
Rackmount Kit:	Mounted to every unit
Housing:	Completely made from steel sheet





www.LINDY.com

Free Manuals Download Website

<http://myh66.com>

<http://usermanuals.us>

<http://www.somanuals.com>

<http://www.4manuals.cc>

<http://www.manual-lib.com>

<http://www.404manual.com>

<http://www.luxmanual.com>

<http://aubethermostatmanual.com>

Golf course search by state

<http://golfingnear.com>

Email search by domain

<http://emailbydomain.com>

Auto manuals search

<http://auto.somanuals.com>

TV manuals search

<http://tv.somanuals.com>