



# XD-V75 Digital Wireless

## **Pilot's Handbook**

**Manuel de pilotage**

**Pilotenhandbuch**

**Pilotenhandboek**

**Manual del Piloto**

**取扱説明書**

## Important Safety Instructions

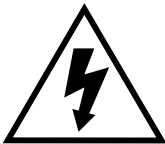

**CAUTION**  
**RISK OF ELECTRIC SHOCK DO NOT OPEN**



**WARNING** : TO REDUCE THE RISK OF FIRE OR ELECTRIC SHOCK, DO NOT REMOVE SCREWS.  
NO USER-SERVICEABLE PARTS INSIDE. REFER SERVICING TO QUALIFIED SERVICE PERSONNEL.

**WARNING** : TO REDUCE THE RISK OF FIRE OR ELECTRIC SHOCK, DO NOT EXPOSE THE  
APPLIANCE TO RAIN OR MOISTURE.

### CERTIFICATION

THIS DEVICE COMPLIES WITH PART 15 OF THE FCC RULES. OPERATION IS SUBJECT TO THE FOLLOWING TWO CONDITIONS: (1) THIS DEVICE MAY NOT CAUSE HARMFUL INTERFERENCE, AND (2) THIS DEVICE MUST ACCEPT ANY INTERFERENCE RECEIVED, INCLUDING INTERFERENCE THAT MAY CAUSE UNDESIRE OPERATION.

**Warning:** Changes or modifications not expressly approved in writing by Line 6 may void the users authority to operate this equipment.

**RF Exposure Statement:** This transmitter must not be co-located or operated in conjunction with any other antenna or transmitter.

**Note:** This equipment has been tested and found to comply with the limits for a Class B digital device, pursuant to part 15 of the FCC Rules. These limits are designed to provide reasonable protection against harmful interference in a residential installation. This equipment generates, uses and can radiate radio frequency energy and, if not installed and used in accordance with the instructions, may cause harmful interference to radio communications. However, there is no guarantee that interference will not occur in a particular installation. If this equipment does cause harmful interference to radio or television reception, which can be determined by turning the equipment off and on, the user is encouraged to try to correct the interference by one or more of the following measures:

- Reorient or relocate the receiving antenna.
- Increase the separation between the equipment and receiver.
- Connect the equipment into an outlet on a circuit different from that to which the receiver is connected.
- Consult the dealer or an experienced radio/TV technician for help.

This Class B digital apparatus complies with Canadian ICES-003.

Cet appareil numerique de la classe B est conforme a la norme NMB-003 du Canada.

The FCC compliance sticker is attached to the THH12 battery compartment.

Remove the THH12 base by unscrewing counter clockwise to see this compliance sticker.



**You should read these Important Safety Instructions.  
Keep these instructions in a safe place**



Before using your XD-V75 Digital Wireless System, carefully read the applicable items of these operating instructions and the safety suggestions.

1. Obey all warnings in the XD-V75 manual.
2. Do not perform service operations beyond those described in the XD-V75 Manual. Service is required when the apparatus has been damaged in any way, such as:
  - liquid has been spilled or objects have fallen into the apparatus
  - the unit has been exposed to rain or moisture
  - the unit does not operate normally or changes in performance in a significant way
  - the unit is dropped or the enclosure is damaged
3. Do not place near heat sources, such as radiators, heat registers, or appliances which produce heat.
4. Guard against objects or liquids entering the device. Do not use or place unit near water.
5. Do not step on cords. Do not place items on top of cords so that they are pinched or leaned on. Pay particular attention to the cord at the plug end and the point where it connects to the device.
6. Clean only with a damp cloth.
7. Only use attachments/accessories specified by the manufacturer.
8. Prolonged listening at high volume levels may cause irreparable hearing loss and/or damage. Always be sure to practice "safe listening."



20546/SDPPI/2011  
3794

20544/SDPPI/2011  
3794



Agência Nacional de Telecomunicações

1569-11-6586



(01)07899153000059



Agência Nacional de Telecomunicações

1773-11-6586



(01)07899153010271

Thank you for your purchase of the XD-V75 Digital Wireless microphone system. It is a sophisticated digital wireless system, yet is easy to configure and use within minutes. With its fully digital transmission, the system provides features and benefits that differ in some ways from previous generations of analog wireless, but in most respects you use it just like other wireless systems. By understanding a few simple concepts, you'll be able to achieve superior audio quality, a secure and dropout-free signal, and the ability to use multiple channels of wireless together without interference or other conflicts.

- Digital transmission in the 2.4 GHz band – license-free operation worldwide
- Avoids interference from high-power TV transmitters in the UHF bands
- Digital technology provides the audio response of a cable, without companding – 24-bit digital converters, up to 120 dBA dynamic range, and 10 Hz – 20 kHz bandwidth
- 4th-generation technology promotes reliable, dropout-free performance
- Fast setup: gain, squelch, or level adjustments not required
- 14 channels that work together simultaneously
- 300 foot (100 meter) range
- Microphone modeling of popular vocal mics
- Beltpack EQ modeling for headset, instrument, and lavalier mics
- Accurate battery-life indicators on both transmitter and receiver
- Real-time LCD indicators display critical performance parameters, including RF and link status, diversity mode, and operating channel
- User-selectable secure digital encryption
- Advanced setup menus on receiver and transmitters provide additional parameter adjustments
- Built-in antenna distribution and rugged, rack-mountable design

## RECOMMENDATIONS FOR BEST PERFORMANCE

- Maintain a clear line of sight between the transmitter and receiver antennas. Typically the receiver antennas should be above head level. Avoid placing the receiver in the bottom of the rack unless remote antennas are employed.
- Avoid placing the receiver behind walls. When this is necessary the receiver's antennas should be remotely located as to be in sight of the transmitter.
- Avoid placing the receiver in close proximity to RF generating equipment including computers, wireless access points and microwave ovens.
- Point the antennas up and 45 degrees from vertical while avoiding touching metal objects like rack or rack rails.
- Avoid blocking antennas in the transmitters. Do not "cup" the bottom of the handheld transmitter. Avoid placing the beltpack transmitter in pockets.

## SUPPLIED COMPONENTS

**XD-V75 Receiver (RX212):** receiver; 9V / 0.5A external universal power supply; short rack ear; long rack ear with D-holes for front-mounting antennas; two (2) BNC-to-BNC connectors; two (2) BNC-to-BNC cables; two (2) half-wave articulating antennas (RDrac); dovetail "key" to join two receivers for rack-mounting; square mounting bracket to "lock" the rear panels together; user's manual.

**THH12 Handheld Transmitter:** transmitter; two (2) AA alkaline batteries; mic stand clip; fitted case.

or

**TBP12 Beltpack Transmitter:** transmitter; two (2) AA alkaline batteries; fitted case; optional lavalier mic with windscreen and clip, headset mic with windscreen, instrument mic with windscreen and clip, or instrument cable with quarter-inch connector.

**Note,** A full line of accessories is available to support the application of the XD-V75 digital wireless microphone systems including: remote antenna, cables, cases, an antenna distribution system and individual transmitter, receiver and microphone components. Please visit [www.line6.com](http://www.line6.com) for more information.

# **XD-V75 DIGITAL WIRELESS QUICK SETUP**

## **Receiver**

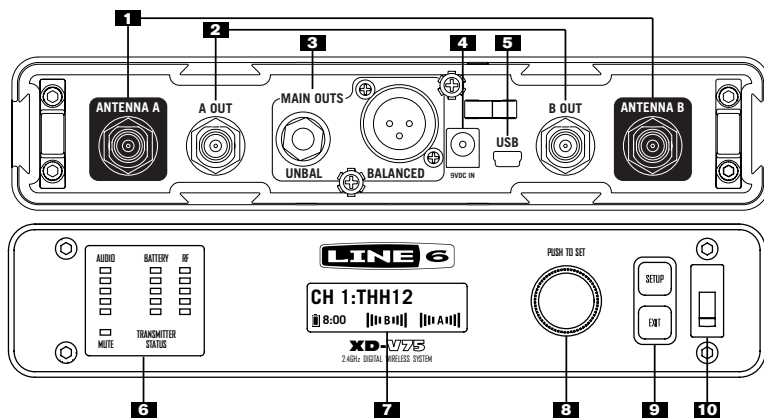

### **1. Antenna A & B Input Connectors (BNC)**

**2. Antenna A & B Output Connectors (BNC)** – to daisy-chain multiple receivers

**3. Unbalanced 1/4-Inch and Balanced XLR Audio Output Connectors**

**4. 9VDC Power Input Connector**

**5. USB Connector** – for firmware updates

**6. Transmitter Status LED Displays**

**AUDIO** – lights green to indicate audio signal level, top clip LED lights red to indicate the audio is clipping

**MUTE** – lights red when transmitter is muted

**BATTERY** – lights green, with all lit indicating full transmitter battery; bottom LED turns red when 1 hour remains, and flashes red when less than 40 minutes remains

**RF** – lights green to indicate transmitter signal strength/quality; with transmitter off, red lights indicate interference on that channel

**7. LCD Display Panel** – main page shows channel, transmitter, battery life, and antenna strength; display also functions as programming window

**8. Edit / Push to Set ROTARY ENCODER** – used to change and set receiver parameters

**9. Setup Button / Exit Button** – used to access setup menus; **EXIT** returns to main display page; these buttons are used along with the **ROTARY ENCODER**

**10. Receiver Power Switch**

Plug the power supply cable into the receiver and AC power, and connect the antennas. Turn on the receiver, press the **SETUP** button, and with the **ROTARY ENCODER** scroll to **SET CHANNEL** and press to select. Scroll to the desired channel and press to select. Press **EXIT**. Connect with an audio cable to a mixer or similar. The receiver is ready to use.

# Beltpack Transmitter

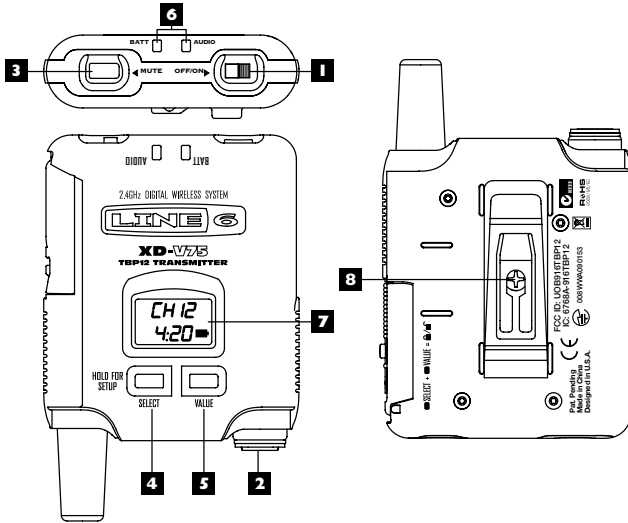

1. **ON / OFF Switch**
2. **Mini-XLR (TA4) Input Connector**
3. **MUTE Switch**
4. **SELECT**
5. **VALUE**
6. **Battery & Audio Status LEDs** – Battery LED is blue when good, red when low, flashing when very low; Audio LED is green for audio signal and red for clipping.
7. **LCD Display Panel** – Backlight will light briefly when transmitter is turned on and when changing pages; will stay lit when muted; display also functions as programming window.
8. **Belt Clip** – Can remove the center mounting screw to reposition or remove, as necessary.

Open the battery door on the side of the beltpack and insert two AA batteries. Slide the **ON/OFF** switch to turn on. Press and hold the **SELECT** button for two seconds, and CH and a flashing channel number will appear on the LCD screen. Press the **VALUE** button repeatedly in order to change the channel number to match the receiver. Press and hold the **SELECT** button for two seconds to select and return to the main screen. The transmitter is ready to use.

## Handheld Transmitter

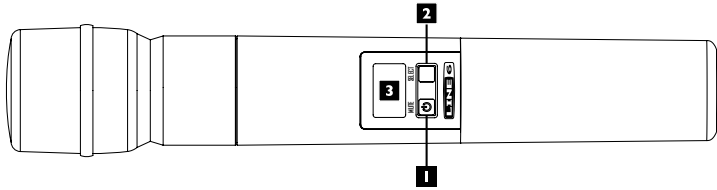

1. **Power / Mute Button** – Press briefly to turn on; press and hold for two seconds to turn off. Press and hold for one second to mute; press briefly to unmute. When in Setup Mode, press this button to change the value of the parameter one step at a time.
2. **Select Button** – Press and hold for two seconds to enter Setup Mode; press briefly to go to next setup page; hold two seconds to exit setup and save changes.
3. **LCD Display Panel** – Backlight will light briefly when transmitter is turned on and when changing pages; will stay lit when muted; display also functions as programming window.

Unscrew the transmitter base and insert two AA batteries. Push the **On/MUTE** button to turn on. Press and hold the **SELECT** button for two seconds, and CH and a flashing channel number will appear on the LCD screen. Press the **On/MUTE** button repeatedly in order to change the channel number to match the receiver. Press and hold the **SELECT** button for two seconds to select and return to the main screen. The transmitter is ready to use.



# WHAT MAKES A WIRELESS DIGITAL?

In a typical analog wireless microphone system the signal between the transmitter and the receiver consists of a very high frequency radio wave carrier that is continually varied slightly in frequency by the audio signal from the microphone (or other transducer). The electronic circuitry in the receiver removes the carrier frequency and leaves the audio signal – the same principle that is used in FM radio broadcasts. The signal is highly compressed upon transmission and expanded at the receiver – the origin of the word “companding.” Analog transmissions are vulnerable to many interference effects from other RF and electromagnetic signals – and the interference is usually audible as well as having the effect of shortening range or rendering the channel unusable.

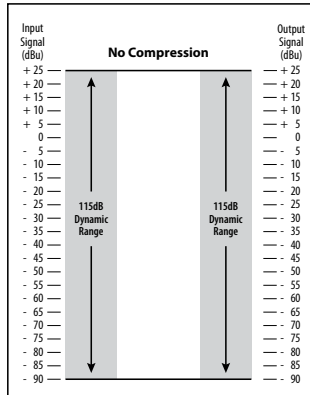
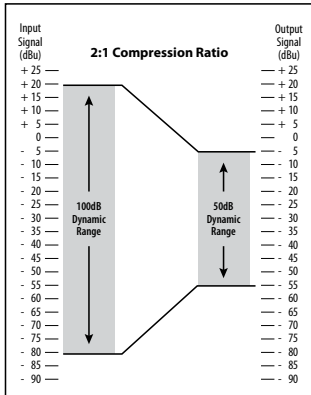

Digital wireless microphone systems provide a much more robust and interference resistant performance. Within the microphone transmitter, the audio signal from the voice or other source is digitally sampled, and the sample is converted into a digital “word” consisting of the electrical equivalent of a string of 1’s and 0’s. As in analog wireless, a very high frequency carrier wave is modulated, but in this case with the digital “stream” of samples so that the carrier frequency only has two distinct states that represent the signal in the same manner that the flat areas and pits on a CD represent the music. The receiver retrieves this information from the carrier and decodes it via a D/A converter and outputs an audio signal that is the replica of what was encoded at the mic.

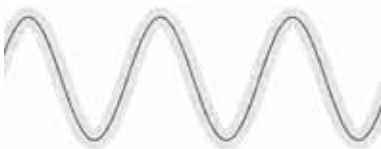

Analog signal with noise

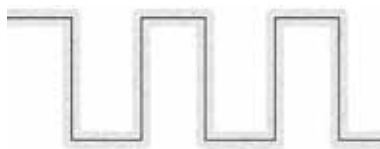

Digital signal with noise

## Benefits of Digital Wireless

As mentioned above, analog wireless transmissions are susceptible to a variety of noise and interference conditions, related to signal strength and/or interference from external electronic devices and other wireless signals. These can ride along with the carrier frequency and its audio signal as added noise, affect the receiver directly because the antennas that pick up the transmitter signal are also wide open to pick up other radio signal in the same general RF band, or interact with the carrier frequency to create additional harmonic frequencies. Problems can come from sources as diverse as a television broadcast signal, other wireless mics in use, digital signal processors, or even malfunctioning fluorescent lighting ballasts or other electrical devices.

While the same physics applies to a digital signal riding on a carrier wave, the digital signal with just two states is more difficult to damage. If the receiver finds that something has come in that is not equivalent

to a digital word of 1's and 0's, that information will be ignored. If noise is riding on those digital words, it is still decoded as one of two states – rather than something in-between, if it were analog. As long as the digitally modulated carrier arrives at the receiver's antenna with sufficient level, it will be accurately decoded. And as with CD players and other digital audio devices, error concealment algorithms may be added to fill in the gaps where there is missing information.

Typically with a digital wireless system, the signal will retain its quality until the signal level is too low, and then it's gone. The main effect that interference has on a digital wireless system is that it will shorten the maximum range between the transmitter and receiver antenna. To alleviate potential problems, maintain line-of-sight between transmitter and receiver, locate the receiver / receiver antennas at a distance from interfering sources such as WiFi routers, and use the HI setting on the transmitter when operating at longer distances.

## **XD-V75 RECEIVER DETAILED SETUP**

For stand-alone placement, position the receiver on a level surface where the front-panel controls and displays are visible. Connect the supplied DC-1G power supply to the **9VDC In** connector on the rear panel; to secure, press a loop of the cable through the cable holder located above the connector to prevent accidental disconnection. Plug the power supply into an available AC outlet that provides voltage from 90 – 240 VAC.

Place the supplied half-wave articulating antennas (RDrac) on to the outer left and right BNC connectors marked **ANTENNA A** and **ANTENNA B**. Rotate a quarter-turn clockwise, and then position the antennas at an approximately 45 degree “rabbit ears” orientation. For details on front-mounting antennas when rack-mounting, or connecting multiple receivers, see Antenna Mounting and Placement.

On the right side of the front panel, turn on the power switch; the display will light. Press the **SETUP** button. The two-line display will show [SELECT FUNCTION] in the top position, and turning the **ROTARY ENCODER** will scroll through a list of editable functions. Scroll to [SET CHANNEL] and press the **ROTARY ENCODER** to select; pressing the **SETUP** button also will select the function.



**Note**, Turn clockwise to scroll down the list, and counterclockwise to return to the top of the list.

The [SET CHANNEL] edit page will show the currently selected channel. Turn the encoder to change the channel; any channel number other than the one currently selected will flash. Press the **ROTARY ENCODER** to select the new channel.

**Note**, The receiver's RF channel will not actually change to a different frequency until the **ROTARY ENCODER** is pressed.

To sync the handheld or belt-pack transmitter to the receiver, follow the procedure in the following transmitter quick setup sections. For more details on scanning channels and using multiple wireless units together, see *Channel Scanning Procedure, Range and Interference Testing, and Minimizing Near / Far Transmitter Effects*.

To adjust the output level of the receiver going to the mixing console or other audio equipment, see *Audio Output and Filter Adjustments*.

**Note**, The receiver provides three display modes. The Main Page shows the currently selected channel, transmitter name or designation, remaining battery life, and the performance of antennas A and B. The [SELECT FUNCTION] page has a scrollable list of editable receiver operations. The Edit page allows changes to be made to the currently selected function. The only user operations available are pressing **SETUP** and **EXIT**, and turning or pressing the **ROTARY ENCODER** knob.

# THH12 HANDHELD TRANSMITTER DETAILED SETUP

To begin, twist the bottom section of the THH12 transmitter counterclockwise, unscrew and remove it. Lightly pull the battery cover tab down with a thumbnail, and open the cover by pulling back; it is hinged at the base of the transmitter. Insert two AA batteries, noting the polarity markings shown in the battery compartment.

**Note,** Use alkaline batteries, or rechargeable NiMH batteries in the 2400 – 2800 mAh range. See *Battery Level Indicator Functions*, for more details.

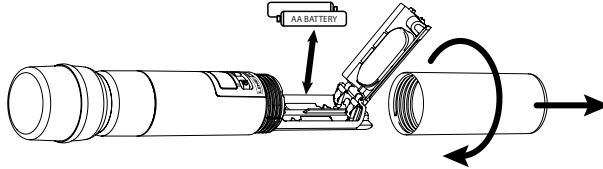

Close the battery cover and replace the bottom section of the transmitter. Press and briefly hold the left **ON/MUTE** button located below the display. The top line shows the currently selected channel, and the bottom line shows remaining battery life. The backlight will light for a few seconds, and then turn off.

**Note,** The transmitter buttons are recessed to prevent accidental activation, so press them down firmly below the recessed surface, until you feel a click. Avoid using pointy objects such as ball point pens.

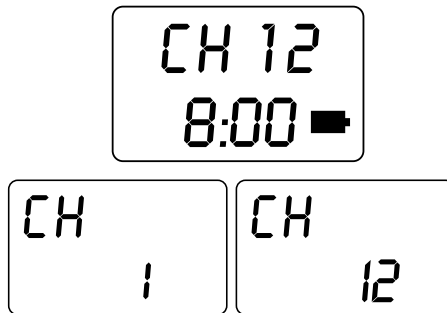

The transmitter must be set to the same channel as the receiver it is to work with (if the receiver is on channel 9, the transmitter must also be set to channel 9). Press and hold the **SELECT** button for two seconds, and the display will show CH on the top line, and the currently selected channel on the second line. Press the **ON/MUTE** button to go through channels 1 through 14, with each click incrementing to the next channel; the channel number will flash. At the desired channel, stop and press and hold the **SELECT** button for two seconds (or do not press any button for 15 seconds). The transmitter will then change to the newly selected frequency, and return to the main display. Check the receiver display to confirm that the transmitter signal is being received.

When the transmitter is on, a quick push of the **ON/MUTE** button will mute the audio from the mic, and the backlight will remain lit while it is muted. The word [MUTE] will appear on the display. Another quick push will un-mute it. The THH12 transmitter has other editable functions, including high and low power modes, selectable microphone models, encryption options, and the ability to give the transmitter a 6-character name that will show on both the transmitter and receiver displays. For more details, see *Setting Microphone Models and Encryption*.

**Note,** The transmitter can be locked so that the user cannot accidentally or deliberately make changes to its settings during use. To set the lock, unscrew the bottom section of the transmitter, go to the back side of the battery compartment, and flip the small micro-switch to the right to lock; the display will show the image of a lock in the lower left corner, and the word [LOCKED] will appear whenever a button is pushed. Replace the bottom section to use. To unlock, flip the switch to the left position, and then changes can be made and the transmitter can be turned off.

## TBPI 2 BELTPACK TRANSMITTER DETAILED SETUP

To begin, press the small oval battery lock button on the left side of the transmitter (same side as the antenna and **OFF/ON** slide switch), and slide the rubberized rectangular latch up toward the switch. The battery door will flip open. Insert two AA batteries, noting the polarity markings on the metal insert on the inside of the door. Close the battery door and slide the battery latch to the original position. Slide the **OFF/ON** switch to the On position; the display will show the currently selected channel and remaining battery life.

**Note,** Use alkaline batteries, or rechargeable NiMH batteries in the 2400 – 2800 mAh range. See *Battery Level Indicator Functions*, for more details.

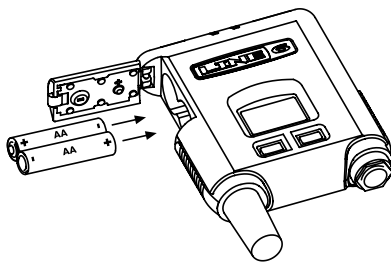

The beltpack transmitter has a TA4M 4-conductor connector for lavalier, headset, and instrument microphones or a quarter-inch instrument cord to be attached. The microphone must have a TA4F connector to mate with the beltpack. Align this connector until it slides easily into the beltpack, and press down until it is seated. To remove, press the button on the side of the TA4F connector and pull straight out. For more on the application of lavalier and headset mics, see *Microphone Usage Tips*.

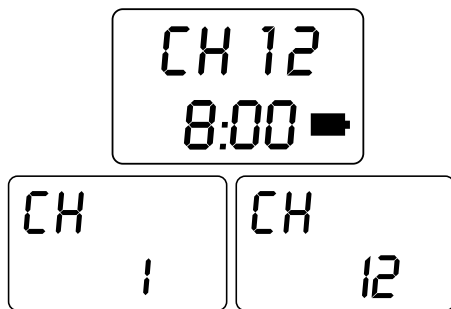

The transmitter must be set to the same channel as the receiver it is to work with (if the receiver is on channel 9, the transmitter must also be set to channel 9). Press and hold the **SELECT** button for two seconds, and the display will show [CH] on the top line, and the currently selected channel on the second line. Press the **VALUE** button to go through channels 1 through 14, with each click incrementing to the next channel; the channel number will flash. At the desired channel, stop and press and hold the **SELECT** button for two seconds (or do not press any button for 15 seconds). The transmitter will then change to the newly selected frequency, and return to the main display. Check the receiver display to confirm that the transmitter signal is being received.

When the transmitter is on, a quick push and hold of the **MUTE** button will mute the audio, and the backlight will remain lit while it is muted. The word [MUTE] will appear on the display. Another quick push will un-mute it. The TBP12 transmitter has other editable functions, including high and low power modes, selectable microphone settings, encryption options, and the ability to give the transmitter a 6-character name that will show on both the transmitter and receiver displays. For more details, see *Setting Microphone Models and Encryption*.

## CONNECTING THE XD-V75 RECEIVER

The receiver features a balanced XLR and unbalanced (tip-sleeve) quarter-inch connector. To connect to a mixing board or powered mixer, use a microphone cable between the receiver output and the mixer's mic-level input – in the same way as you would connect a wired microphone. In its [NORMAL (+0 dB)] setting, the output of the XD-V75 receiver is virtually identical to that of the microphone on the transmitter (and the microphone models on the THH12 handheld transmitter emulate the output levels of the particular microphones they model). If desired, the output can be adjusted in 1-dB steps from -18 dB to +12 dB via [SELECT FUNCTION: OUTPUT ADJUST]; see *Audio Output and Filter Adjustments* for details.

To connect to an instrument amplifier or other audio equipment with a quarter-inch connector such as a signal processor or effects unit, use a quarter-inch to quarter-inch instrument cable. The output level adjustment also affects this connector.

**Note:** Do not use TRS balanced cable to connect to unbalanced output. The ring of the TRS connection on the ¼" out is a digital communication line used to talk with other Line6 wireless products. Connecting a TRS in this manner may create some digital noise when connected to a balanced audio input on a mixing console. Only an unbalanced ¼" inch cable is recommended for this audio output usage

## COMPATIBILITY WITH OTHER LINE 6 WIRELESS DEVICES

The XD-V75 utilizes our latest digital wireless transmission method, and is fully channel compatible with the XD-V35, as well as Relay™ G30, Relay™ G50, and Relay™ G90 models that have Version 2 software running RF2 mode. Multiple units of any of these models can be mixed used within the same location as long as each is on a unique channel and no more than 14 are used simultaneously.





The XD-V75 receiver can also automatically receive transmissions from the previous generation of Line 6 wireless products, which include the XD-V30, XD-V70, and Relay™ G30, Relay™ G50, and Relay™ G90 models with Version software, now referred to as RF1 mode. However, it is not recommended to mix usage of the RF1 and RF2 modes within the same location due to the channel frequencies in each system not being compatible.

If an XD-V75 unit is being added to a setup that already includes any devices running in RF1 mode, the XD-V75 can be used to update the older devices to run RF2 mode by using an internet-connected computer attached to the XD-V75's USB port. See the *Firmware Updating Procedure* section for more information. Alternatively, the XD-V75 transmitters can be setup to operate in RF1 mode if it is necessary to use the transmitters with older Line 6 receivers. To set the THH12 or TBP12 transmitters into the RF1 mode, enter Setup mode to display the current channel, then while holding down the **SELECT** button press and release the **ON/MUTE** button on the THH12 or **VALUE** button on the TBP12. The display will briefly show [XD-V75 RF1] or [XD-V75 RF2] to indicate whether it is operating in the old or new mode, respectively. This setting is retained when powering off, so as a reminder the display will also show this indication [RF1 or RF2] each time power is turned on. The XD-V75 receiver will display a [To] on the far right of the display to indicate while communicating with a RF1 software transmitter.

## CHANNEL SCANNING PROCEDURE

Though the Line 6 wireless microphone system operates in the unlicensed 2.4 GHz band – above the frequencies used by most wireless microphone systems, cellular phones, and other voice communication devices – the band is not unused, and does include WiFi routers. The receiver contains a sophisticated scanning capability that can determine the existence of interfering wireless devices that would compromise the performance range of operation on certain channels, and can also help assure that the selected wireless mic channels do not interfere with other wireless devices. Use the following procedure to minimize interference; if you are adding new wireless units to a previous installation with Line 6 systems, first turn on the existing transmitters so their frequencies can be detected.

Press the **SETUP** button on the receiver. The [SELECT FUNCTION] screen will appear; scroll with the **ROTARY ENCODER** to [CHANNEL SCAN], and press the **ROTARY ENCODER** to begin the scanning process. After approximately 6 seconds, the display will show channel numbers 1 through 14 on the bottom line, with a status indicator above each channel. The indicators and their applications are:

<b>Blank</b>	Little to no RF – best channels to select for use
	XD-V70-class transmitter already on and using that channel (or other Line 6 wireless systems operating in RF1 mode)
	XD-V75-class transmitter already on and using that channel (or other Line 6 wireless systems operating in RF2 mode)
	Non-Line 6 low-level RF signal – can use these channels with minimal effect on range
	Non-Line 6 medium-level RF signal – using these channels will likely result in lessened range for that particular transmitter
	Non-Line 6 high-level RF signal – using these channels will result in a significantly compromised range of operation.

The currently selected channel number for the receiver will be underlined.

**Note**, No audio will function while the receiver is on this channel-scanning page; you must select a channel by pressing the **ROTARY ENCODER** or press the **EXIT** button and leave the page to resume audio.

Turn the **ROTARY ENCODER** to scroll through the list of channels; a flashing underline will follow the channel number as you scroll. Once you have highlighted a blank, unused channel, press the **ROTARY ENCODER** to select it. The receiver display will return to the main page with the new channel number shown.

**Note**, Any of the channels can be selected, regardless of the RF conditions displayed for the channel. Selecting a channel showing significant RF interference can result in lessened range for the associated transmitter.



Turn on the transmitter you would like to use with the receiver, and use the procedure described in the Quick Start section to set it to the same channel number. To set up multiple receivers and transmitters, leave each set on as you scan with the next receiver and select another open channel. Alternately, after you have performed the scan with the first receiver, note all the open channels with little or no interference, and set the remaining receiver / transmitter pairs to those channels.

**Note:** Make sure all powered on Line6 TX units are a minimum of 2 meters away from scanning RX antennas. This will avoid overload and incorrect scanning function while in this mode.

## AUDIO OUTPUT & FILTER ADJUSTMENTS

### Receiver Output Level Adjustments

The default receiver output from the XD-V75 receiver is +0 dB or unity gain. This allows the wireless unit to use the same mixer gain levels as the equivalent wired microphone, and connect to the mic-level input of the mixer. If a boost or attenuation from this level is required, the level may be adjusted, using the following procedure.

**OUTPUT ADJUST:**  
**+0dB (NORM)**

Press the **SETUP** button, and under [SELECT FUNCTION] scroll with the **ROTARY ENCODER** to [OUTPUT ADJUST]. Press the **ROTARY ENCODER** to select. The bottom line of the display will show a value ranging from -18dB to +12dB. In default mode it will show [NORMAL (+0 dB)], and will increment in 1 dB steps through the range, going clockwise to increase the level and counterclockwise to decrease it.

When the desired level is reached, press the **ROTARY ENCODER** to select and return to the main screen. As you turn the **ROTARY ENCODER** and increase or decrease the gain, the level changes will go into effect immediately.

Typically, you will use the [NORMAL] or unity gain position, and use the trim or gain control and the channel knob or fader on the mixer to boost or attenuate the signal level. This setting will usually result in the best overall audio system signal-to-noise ratio. With a mix of wired and wireless microphones, using the [NORMAL] position will allow you to keep the channel faders and trim controls at similar positions for similar audible levels. If your mixer just has channel level knobs with no additional trim or gain control, you might choose to make modest level changes at the receiver.

**Note,** Raising the receiver's output level, even to the maximum +12 dB, is not equivalent to a line-level signal. Use the mic-level setting / input on the mixer or other audio device that is next in the signal chain.

Boosting the output level at the receiver can give less headroom before clipping its output, adding distortion on the microphone peaks. You will typically add gain at the receiver only when the user of the microphone is either speaking too softly or is too distant from the microphone and it is more convenient to add it there rather than at the mixer level control, or if your receiver's signal is going to a device that has no level control and you require more level. Return to [NORMAL] when the situation is corrected.

Attenuating the output level substantially can lower the signal-to-noise ratio, resulting in more noise and hiss coming through the speakers. You will typically add attenuation at the receiver only when the receiver output is clipping the mixer or other audio device input and there is no attenuation control available at the mixer.

**Note,** The general rule of audio gain staging is to enable as much gain as possible at each stage of the audio signal, while keeping the level below clipping at the input / program peaks. This process starts with the microphone element itself, and making sure the user is providing a good signal by not having the mic too far away or speaking too softly. In this case, the [NORMAL] setting on the XD-V75 receiver should provide the next gain stage with adequate level with enough headroom to prevent clipping. The trim or gain control on the mixer is the next stage to adjust level, keeping it below clipping on peaks. The channel fader follows, and then either the subgroup fader or the main mixer output level to the amplifier. Obtaining the best level at each stage in the audio chain means you will need less gain at the amplifier to reach the same output level from the speakers, and will be amplifying less electronic hiss and noise and more of the desired signal.

## Dynamic Filter Adjustments

The dynamic filter allows users to select from [OFF] (no filtering), [NORM] (for music applications), and [TALK] (for spoken word applications). When active, the filter minimizes handling noise and stage vibrations, via a downward expander with a dynamic high-pass filter. In the [NORM] mode, when the microphone input level falls below a fixed threshold, overall level is reduced by approximately 6 dB while simultaneously rolling off frequencies below 200 Hz. The [TALK] setting increases the level reduction which is more appropriate for speech applications.

To change the dynamic filter setting, press the receiver **SETUP** button and scroll to [DYNAMIC FILTER]. Press the **ROTARY ENCODER** to select, and scroll to the desired setting. Press the **ROTARY ENCODER** to select that setting and return to the main menu. The dynamic filter becomes immediately active upon selection.

**Note,** For applications where the microphone is not in close proximity to the mouth or the performer is speaking/singing at low levels, best results may be obtained by setting the Dynamic Filter to the OFF setting.

## SETTING MICROPHONE MODELS

### Selecting Mic Models with the THH12 Handheld Transmitter

The THH12 handheld microphone transmitter features selectable models based on a number of popular vocal microphones, including their audio quality, frequency response, and output level. The models include the Shure® SM58® and Beta58® and SM57®, Sennheiser® e835 and e935, Audio-Technica® AE4100, Electro-Voice® N/D767a, Audix® OM5, and AKG® D5.

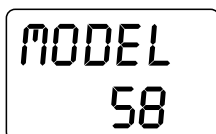

**Note,** The models begin with the response parameters of the Line 6 microphone element, and shape it to attain the characteristics of other microphones. Some physical characteristics of these other microphones, such as their off-axis response, polar pattern, and proximity effect are unable to be duplicated with a single mic element.

To select a particular microphone model, press and hold the **SELECT** button until the display changes to the channel setting screen. Quickly press the **SELECT** button two more times to go to the [MODEL] page. You will see a two- or three-digit designation for the currently selected mic model; press the **ON/MUTE** button to scroll through the available models – one per click. The model names will flash. To select one of the models, press the **SELECT** button (the display goes to the next page of selection options) or do not push any buttons for approximately 15 seconds.

Display	Manufacturer	Model
L6	Line 6	Custom
58	Shure®	SM58
b58	Shure®	Beta 58
57	Shure®	SM57
835	Sennheiser®	e835
935	Sennheiser®	e935
41	Audio-Technica®	AE4100
767	Electro-Voice®	N/D767a
o5	Audix®	OM5
d5	AKG®	D5



**Note,** In a production using both wired and wireless microphones, the modeling allows the user to select a wireless mic model that is similar to the majority of wired ones. This selection should help reduce potential feedback from dissimilar microphone frequency responses when using global EQ settings on the audio system.

\*All product names herein are trademarks of their respective owners, which are in no way associated or affiliated with Line 6. These trademarks of other manufacturers are used solely to identify the products of those manufacturers whose tones and sounds were studied during Line 6's sound model development. SHURE and SM58 are registered trademarks of Shure Incorporated. Sennheiser is a registered trademark of Sennheiser Electronic Corp. Audix is a registered trademark of Audix Corporation. Audio-Technica is a registered trademark of Audio-Technica Corporation. Electro-Voice is a registered trademark of Telex Communications, Inc. AKG is a trademark of AKG Acoustics GmbH.

## Selecting Equalization Models with the TBP12 Beltpack Transmitter

The TBP12 beltpack transmitter may be used with a wide variety of lavalier, headset, and instrument microphones, as well as with a quarter-inch instrument cable. Some of these microphones are available from Line 6; with the correct wiring and a TA4F connector, virtually any mic may be used. To help the user achieve the best performance from the microphones in a multitude of applications, sets of equalization models are provided.

**Note,** See the *TA4F wiring instructions* in the Appendix at the end of the manual.

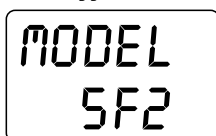

To select a particular equalization model for a lavalier, headset, or instrument microphone, press and hold the **SELECT** button until the display changes to the channel setting screen. Quickly press the **SELECT** button two more times to go to the [MODEL] page. You will see a three-digit designation for the currently selected mic EQ model; press the **VALUE** button to scroll through the available models – one per click. The model names will flash. To select one of the models, press the **SELECT** button (the display goes to the next page of selection options) or do not push any buttons for approximately 15 seconds.

Name	Application	Description
SF1	Speech Filter 1	Gentle high-pass
SF2	Speech Filter 2	Gentle high-pass and high-cut
SF3	Speech Filter 3	Moderate high-pass and high-cut
SF4	Speech Filter 4	Gentle high-pass, mid-cut and high-cut
SF5	Speech Filter 5	Moderate high-pass, mid-cut and high-cut
SF6	Speech Filter 6	Aggressive high-pass, mid-cut and high-cut
IF1	Instrument Filter 1	Guitar cable high frequency roll-off
IF2	Instrument Filter 2	Woodwind instrument enhancement
IF3	Instrument Filter 3	Brass instrument enhancement

## Microphone Usage Tips

Unlike a handheld microphone where the user typically speaks or sings directly into the mic element – where the full frequency response of both the person and the mic is available, lavalier microphones are placed on the body in a variety of places. Being farther away from and below or to the side of the mouth, the level is usually much lower, plus the frequency response lacks the highs as well as the lows from being near the mic element. The sound is often hollow and emphasizes the midrange. When you increase the gain to bring back the level of the voice, other extraneous noises are also more easily picked up and amplified.

The sometimes substantial equalization corrections necessary to make the voice of the lavalier user sound “natural” can be quite difficult to achieve without feedback problems, especially with live audio at higher levels. Using a combination of mic placement and EQ is the best compromise for good sound

at usable levels – and the transmitter’s EQ response models will help the process.

Try to maintain a constant distance and relationship between the user’s mouth and the microphone. In live theatre this is often done by placing a small mic in the hairline toward the front side of the head or right above the ear. With mic placement on the collar or shoulder area, changes in level can occur as the user’s head turns; experiment with the location of the mic to minimize this effect. Mic placement in the center of the chest can help with the level changes, but is farther from the voice and quite shielded from the direct energy of the voice, so typically provides a hollow midrange or “chest” sound to the voice.

Directional (cardioid) lavalier microphones can help isolate the voice of the user from the background noise that may be picked up by an omnidirectional mic. They are more sensitive to the movements of the user’s head, with more change in level when speaking toward or away from the front of the mic. In addition, they are more prone than omni mics to handling and cable noise, so the user needs to be more careful about movement. The lavalier EQ models in the TBP12 beltpack provide a high-pass filter (low-end rolloff) to help reduce this extraneous noise.

When appropriate, a headset microphone can solve most of these problems of level, compromised frequency response, feedback potential, handling noise, and pickup of background sounds. A number of low-profile models are available. To minimize breath noise and pops from certain consonants, use the mic’s wind filter and position the mic element toward the corner of the mouth.

In a situation where the audio is recorded or broadcast rather than live, or the user has a significant distance between his/her location and the speaker system, substantial equalization changes and a more natural sound are easier to achieve.

## SETTING OTHER TRANSMITTER FUNCTIONS

### Naming Transmitters

The handheld transmitter has a default name of [THH12] and the beltpack of [TBP12]. The transmitters can be given a six-character name to readily identify them on both the transmitter and its associated receiver. Using the [NAME] function, transmitters can be given a six-character name that will show on the main screen of the LCD display; the name is transmitted to the receiver and also appears on the receiver’s main display page. The character set includes letters and numbers (plus a dash and blank), so you can identify them by the user’s name or by their function, as desired.

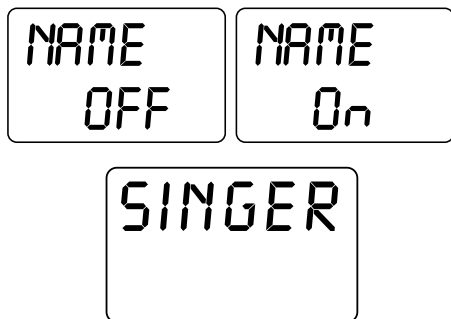

To name the transmitter, press and hold the **SELECT** button until it changes to the channel select page. Quickly press the **SELECT** button four more times until you reach the [NAME] page. The default position is [OFF]. Press the **ON/MUTE** button on the handheld or the **VALUE** button on the beltpack to select [ON]. Press the **SELECT** button, and the default name (or if already named, the transmitter’s name) appears with the first letter flashing. Press the **ON/MUTE** or **VALUE** button repeatedly to scroll through the alphanumeric list until the desired letter or number appears; when reached, press **SELECT** to keep it and go to the next character. When the final character has been reached, press and hold the **SELECT** button to go back to the main screen. The name shows on the transmitter screen and is

transmitted to the receiver and displayed on the receiver LCD main page.

## Transmitter Power Level Select

The Line 6 digital transmitters give the option to select a lower power transmission, which is useful for minimizing interference when using them along with WiFi or other 2.4 GHz devices, and for extending battery life when the transmitters are used closer to the receiver antennas. When you are using wireless systems on the same channels at nearby venues or stages, the lower power setting will often allow them to work at each location without interfering with each other. For maximum range, use the (default) higher power setting.

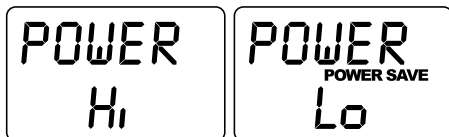

To set the transmitter power, press and hold the **SELECT** button until the channel screen appears. Quickly press the **SELECT** button one more time to reach the [POWER] screen. Press the **ON/MUTE** button on the handheld or the **VALUE** button on the backpack to change between [HI] and [LO] (Power Save). Press and hold the **SELECT** button to select and go back to the main screen.

**Note.** If the transmitter is set at LO power and you experience short range or interference, change it to the HI setting to increase the range. Alternately, position the transmitter closer to the receiver antennas, make sure the antennas are line-of-sight, or select another frequency that has less interference.

## Locking, Unlocking, and Muting the Transmitter

The THH12 and TBP12 transmitters can be locked to prevent accidental button pushes from handling during use. When locked, the user cannot mute or turn off the transmitter, or change the frequency or other settings, assuring that an error with a transmitter will not interrupt the event. After use, it is easy to unlock the transmitter to turn off or change settings. When not locked, the transmitter can be muted so that it keeps transmitting but audio is temporarily disabled.

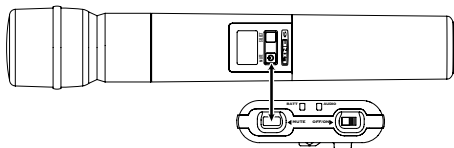

To mute the THH12 handheld, quickly press the **ON/MUTE** button until it clicks; press again to unmute. The word [MUTED] will appear in place of the transmitter name, and the backlight will stay lit. To mute the TBP12 backpack, push and briefly hold the **MUTE** button on the top of the pack; press again to unmute. The display works identically to the handheld. When the mic is muted and you press the **SELECT** button to enter another parameter page, the word [MUTED] will remain in tiny characters in the left center of the display as a reminder. When a transmitter is [MUTED] the red **MUTE LED** will light on the receiver.

To lock the THH12 handheld, turn it on and assure that the desired settings are completed, and that the receiver display shows the signal. Unscrew the end of the battery compartment, and locate the micro-switch on the back; move it to the right toward the lock symbol. Test by pressing the **ON/MUTE** or **SETUP** buttons, and the word [LOCKED] will appear on the top line of the briefly lit display. Unscrew the compartment and move the switch to the left to unlock.

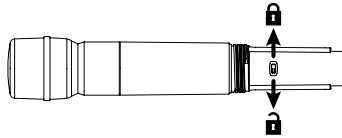

To lock the TBP12 belt pack, turn it on and check the settings, and check the receiver display for signal. With two fingers, press the **SELECT** and **VALUE** buttons at the same time and hold for two seconds. The word [LOCKED] will appear on the top line of the display for a moment, and then revert to the main screen. Test by pressing any of the buttons to assure that it is locked. Locking will also temporarily disable the **OFF/ON** switch. To unlock, again hold the **SELECT** and **VALUE** buttons for two seconds.

Press together and hold

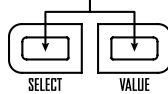

## Setting Encryption

The XD-V75 Digital Wireless microphone system permits a unique 24-bit encryption code to be applied to the audio coming from the transmitter, creating a secure link between it and the associated receiver – over 16 million codes are possible. Encryption prevents the audio signal from being captured and deciphered when wireless is being used during confidential meetings and proceedings. The audio entering the microphone element is encoded within the transmitter, and is decoded within the receiver; the radio signal in between is secure.

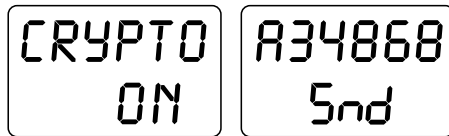

The encryption code is entered into the transmitter first, and then is transferred to the associated receiver. Make sure that you have already set both to the same frequency. **Note**, When using the “Send” crypto key function both transmitter and receiver will need to be set to the same channel and communicating in non-Crypto mode before this feature can be used. With the transmitter on, press and hold the **SELECT** button to go to the channel page, and then press the button three more times to go to the [CRYPTO] page. The encryption mode is either [OFF] or [ON], and the word will flash; press **ON/MUTE** on the handheld or **VALUE** on the belt pack to switch between them. Choose [ON] to set a code.

**Note**, The transmitter will begin transmitting in encrypted mode when [ON] is selected and setup mode is exited. If you are going through the edit screens and do not want to change the current encryption setting, pressing the **SELECT** button again without pressing **ON/MUTE** or **VALUE** will bypass this page, leaving encryption in its current off or on state, and go on to the next edit page. To turn off encryption, go to the [CRYPTO] page, press the **ON/MUTE** or **VALUE** button to go to [OFF], and press the **SELECT** button to exit. In a few moments, the system will return to the unencrypted transmission mode.

The transmitter automatically and randomly generates a six-digit hex code (characters 0–9 and A–F), which it uses for encryption and remembers even when the transmitter is turned off. The only way to “lose” this code is to turn the [CRYPTO] page to [OFF]. The code may be seen only once, by pressing the **SELECT** button immediately after setting [CRYPTO] to [ON]; it will appear on the backlit display for two minutes or until the **SELECT** button is pressed again to go to the next page. As soon as **SELECT** is pressed for the second time, the transmitter will go into encrypted mode.

To transfer the encryption code to the associated XD-V75 receiver that is set to the same channel, the receiver must be on the encryption page. Press the **SETUP** button to go to [SELECT FUNCTION] and scroll with the **ROTARY ENCODER** to [ENCRYPTION], then press the encoder to enter that function.

Scroll with the **ROTARY ENCODER** to go to [MODE: AUTO SENSE / NEW KEY 1: xxxxxx], with the cursor underlining the letter A. If you need to go to [NEW KEY 2], pressing the **ROTARY ENCODER** once more will advance the cursor to the number 1, and turning the encoder will go to number 2. Pressing the **ROTARY ENCODER** one more time will advance it to the first character of the six-digit code, which will flash and change as the encoder is turned.

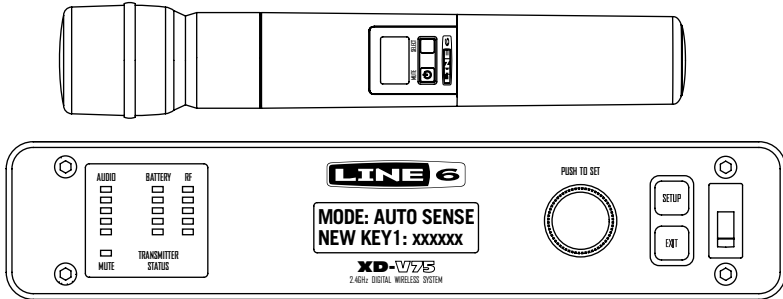

**Note,** Two encryption key “slots” are provided on the receiver, so that you can use two encrypted transmitters at different times with the same receiver – for example, having a handheld and beltpack at the ready for a receiver. The encryption keys are generated at the transmitter, so they will be different for each one; use [NEW KEY 1] for the first and [NEW KEY 2] for the second.

The easiest way to transfer the encryption code to the receiver is to have the transmitter nearby (no more than a few feet away from) the receiver, and put the receiver into encryption mode described above before generating the code in the transmitter. When the code is displayed in the transmitter display, press and continue holding the **ON/MUTE** on the handheld or **VALUE** on the beltpack to transmit the code to the receiver; you will see Snd appear in the transmitter display. At the same time, while on the receiver’s [MODE: AUTO SENSE] page with the cursor on the first digit of the code, press the **ROTARY ENCODER** after the transmitter completes transmitting the code to the receiver, then release the button on the transmitter.

**Note,** After the transmitter has been set to encryption mode, the main display page will show the letters CR in place of the normal CH to indicate that transmissions are encrypted.

Alternately, the code can be manually transferred to the receiver. Either write down the code from the transmitter display and later enter it into the receiver on the [ENCRYPTION] page, or bring the transmitter to the receiver during the two minutes the code is displayed and manually enter what is on its display. To manually enter an encryption code from the [MODE: AUTO SENSE / KEY 1 (or 2): xxxxxx] screen, press the **ROTARY ENCODER** until it is on the first x character which will flash, and then turn the **ROTARY ENCODER** until the desired character appears. Press the encoder again and the next character can be changed. Continue this process until the last character has been entered, and then press the **ROTARY ENCODER** one last time to store the code.



**Note,** Though the direct transmission of the encryption code from the transmitter to the receiver is faster and secure, since it is done at very low power in close proximity to the receiver, some users may want to make sure that the code is never transmitted –thus the ability to enter it manually. Also, for redundancy, in some cases the user might want to have two receivers in place holding the same encryption code for the transmitter, with the second one as a backup.

To change to a new encryption code, when using a currently encrypted transmitter with another receiver or desiring a fresh code, first go to the [CRYPTO] page on the transmitter. Using the **ON/MUTE** or **VALUE** button, change the setting from [ON] to [OFF] and press **SELECT** to cancel the

previous code. Then hold **SELECT** to re-enter setup mode, go to [CRYPTO], and select [ON] again. Follow the same procedure as before to view the code on the transmitter and transfer it automatically or manually to the receiver.

During the operation of the system, if the receiver is receiving a signal from a transmitter that is encrypted, and the matching code has been stored, a lower-case letter c will appear on the upper right corner of the display. If the correct code is not in the receiver, or encryption has been turned off at the receiver, the display will read [BLOCKED]. Audio cannot be received until the code has been entered into the receiver, or a new code has been generated at the transmitter and transferred to the receiver.

## Battery Level Indicator Functions

Line 6 transmitters contain battery level indicators that can accurately assess the remaining battery life, and show this information on both the transmitter and the associated receiver. These indicators are calibrated to commercial alkaline batteries, and can also provide useful information when used with rechargeable batteries.



When the transmitter is turned on, the bottom line of the display will show the remaining battery life in hours and minutes, with a battery icon next to the time. The remaining battery life is shown in increments of twenty minutes (Hours:20). The initial time indicated just after the transmitter is turned on, and for the first few minutes, will often show more time than is actually remaining – this is due to the characteristic of alkaline batteries to temporarily increase in voltage for a short time after a period of rest. For best accuracy, wait about twenty minutes after transmitter turn-on to rely on the time indicator.

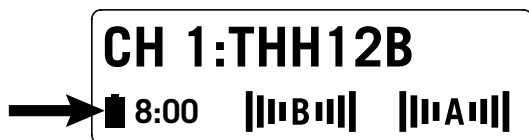

On the receiver, the remaining battery life will be shown on the display in the lower left-hand corner of the main page, and changes in sync with the transmitter's indicator. In addition, the middle 5-position LED ladder indicates remaining battery life in one-hour steps. When remaining battery life is more than five hours, all five LEDs are lit, with between four and five hours left, four LEDs are lit, and so on. When less than one hour of battery life remains, the bottom LED will turn from green to red – and will begin to flash in the last 40 minutes of life.

NiMH (nickel metal hydride) batteries in the 2400 – 2800 mAh range are recommended as rechargeable batteries to use with the THH12 and TBP12 transmitters. Make sure that the batteries fit properly in the battery compartments to prevent damage, since these batteries can vary in diameter and length. They need to be charged in the correct external battery charger; the transmitters are not designed for batteries to be charged internally. Because the transmitter's battery meter was calibrated for alkaline batteries, they will not be as accurate in calculating the remaining battery life when using rechargeable batteries.

**Note,** Carbon-zinc batteries are not recommended.

# RANGE AND INTERFERENCE TESTING

The frequency scanning capability of the XD-V75 receiver, plus the A / B antenna metering on the display and the RF LED ladder, provide powerful tools for selecting the clearest channels, avoiding interference, and preventing the wireless microphone systems from interfering with other wireless devices. Using these functions before operating the systems in new locations will ensure trouble-free and compatible performance.

## Scanning the Channels for Interference

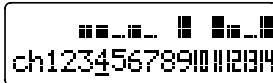

The first step is to scan the channel using the process in Channel Scanning Procedure. Channels 1 – 14 are spread across a 76 MHz band of the 2.4 GHz spectrum, and the frequencies are specially selected for compatible operation and to minimize interference with other equipment working in the same spectrum. Perform a scan with all transmitters off at first when in a new location.

Once the scan is complete, look at the results on the channel display, especially noting any channels with the half block or full block icon above them. This indicates significant existing interference to those channels, which will limit the range of transmitters using those channels (and also means that a transmitter on that channel could interfere with the existing other equipment).

## Detecting Interference with the RF Meter

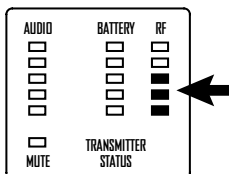

The XD-V75 receiver has an LED ladder (stacked LED meter) labeled RF, which detects signals on the channel frequencies to which it is currently set (for example, when set to Line 6 channel 7, it detects frequencies with either a 2.433 GHz or 2.467 GHz center frequency). These LED's are green when receiving signal from a Line 6 transmitter, and red when the transmitter is off and interfering signals on that frequency are present. If the receiver is on and the associated transmitter is off, and one or more of the LEDs on the RF meter are lit red, it is detecting a potentially interfering signal. The more LEDs that are lit, the stronger the signal – and the more it will interfere with the range and performance of a transmitter on that channel.

## Detecting Interference with the Antenna A & B Display

The main receiver display page shows the received signal strength on antennas A and B for both of the frequencies emitted from the associated Line 6 transmitter. They can also show the presence of interfering signals when the transmitter is off.

The four vertical bars (Antenna Bars) that can appear on the left and right sides of the A and B on the display represent increasing levels of RF signal – with 4 bars being the highest level. With the transmitter off, the appearance of one or more bars next to those letters shows a potentially interfering signal on that channel which can affect the performance and range of the wireless system.

Since the XD-V75 transmitters use two frequencies simultaneously, the bars to the left of each letter represent the lower of the two frequencies, and the bars to the right of each letter the higher frequency. In some cases, only one of the two frequencies will show interference. The following chart describes the potential effect on performance.

Antenna Bars	Estimated Line 6 Usability	Interferer Signal Strength	Estimated Line 6 Maximum Range
4	Bad	>(-60dBm)	0-10ft
3	Poor	>(-70dBm)	1-25ft
2	Fair	>(-80dBm)	25-50ft
1	Good	>(-90dBm)	50-100ft
0	Excellent	No interference	>200ft

**Note,** When the associated handheld or belt-pack is on, these same bars show the transmitter's signal strength at the receiver's antennas for both frequencies on the channel. During normal operation, you should see four bars on both sides – and as you begin to exceed the range you will see fewer bars. At three bars the signal will still be good, and at two it should still be acceptable and provide reliable audio.

## Walk-Testing the Performance Area

When first setting up a wireless system in a new location, it is good practice to position the receiver and its antennas where they will remain during the event, and then walk the entire performing area with the audio system on and the transmitter active. Talk and listen for signal dropouts or other problems, and note where they are with respect to your antenna placement.

If you for some reason cannot turn on the audio system, with one person to walk with the transmitter and another to monitor the receiver, you can use the RF meters to find locations with low signal strength that could potentially cause problems. You can also monitor the signal through a headset connected to the mixer, if the receiver has been connected to it.

If you are using remote antennas, you can reposition them to obtain better coverage and improve or eliminate areas with lower signal strength. With the antennas connected to the receiver, you can place it where it has better line-of-sight to the transmitter.

**Note,** If there are still spots where poor signal reception occurs, mark the problem areas on the floor with removable tape and let the user know to avoid those areas.

## Avoiding WiFi Interference

If you see several half or full blocks that are adjacent to each other on the channel scan screen, it is likely that you are seeing a WiFi channel that is operating in the same location. If you can locate that equipment and position your receivers farther from it, or remote the receiver antennas farther from it, the interference may lessen in strength. Also be aware that your transmitters may interfere with the WiFi network operation if they are transmitting close to the routers or other WiFi connected devices. The best option when you see strong interfering signals is to use the other available Line 6 channels that are clear.

The most commonly used WiFi channels (note that their numbering does not correspond with Line 6 channels) are channels 1, 6, and 11. These channels each cover 20 MHz of spectrum, and usually only one WiFi channel will be in use in a location. In the majority of cases, any of the Line 6 wireless channels will be compatible with existing WiFi with minimal to no interference, and in all cases you will be able to use eight channels of Line 6 wireless while completely avoiding the WiFi channel. Use the channels in the chart located in the manual Appendices, Channel RF Frequency Chart.

**Note,** Cellular phones with Bluetooth or WiFi capabilities transmit signals in the 2.4 GHz band, so are a potential source of interference when near the receiver antennas. Use these functions of your phone



at least a few feet away from the receivers when you are operating the wireless system.

## MINIMIZING NEAR / FAR TRANSMITTER EFFECTS

Line 6 digital wireless systems are designed so that a receiver only passes audio from a transmitter that is set to the same channel. While other nearby transmitters and RF sources will not create audio in a receiver not on their channel, under certain conditions they can have an effect on range. When you are using several channels of wireless, following some simple procedures will minimize any near / far effects.

The XD-V75 receiver constantly monitors the signal from its transmitter, and increases gain (sensitivity) as the transmitter moves farther away to maintain a good RF signal level. The near / far effect can happen when the transmitter is at a distance from the receiver's antennas, and transmitters on different channels are being used near the antennas. The strong signal from the nearby transmitters, especially if they are close in frequency to the channel the receiver is set on, can mask the signal from the distant transmitter – and sometimes cause the audio from that transmitter to drop out.

For example, if the transmitter on the same channel as the receiver is 50 feet away, and another transmitter is 3 feet from the receiver's antenna, the range of that distant transmitter might be affected. Avoid this potential problem by positioning the receivers and their antennas at a more equal distance from the transmitters that are in use.

### Solutions include:

- Making sure that any transmitter is at least 6 feet away from the receivers, and that other RF sources (such as WiFi routers) are also at a distance from them.
- Placing the antennas higher, which can lessen the difference in distance as well as increase line-of-sight with the distant transmitter.
- Using remote antennas and placing them approximately equidistant from each group of transmitters (for example, positioning a remote antenna connected to **ANTENNA A** nearer to the closer transmitters, and one connected to **ANTENNA B** nearer to the distant transmitters).
- Moving the receiver associated with the distant transmitter closer to it, or using remote antennas attached to that particular receiver to get closer.
- Using the LO transmitter power setting for the nearby transmitters, and the HI power setting for the distant transmitter.

## ANTENNA MOUNTING AND PLACEMENT

The XD-V75 receiver may be used stand-alone, or may be rack-mounted. When used by itself and placed on a surface, the antennas are typically mounted on the rear and connected to the BNC connectors labeled **ANTENNA A** and **ANTENNA B**. For rack-mounting, Line 6 has provided a variety of options, including a long rack ear with cutouts for mounting the supplied BNC connectors to front-mount antennas, a pair of BNC cables to connect the receiver to those antennas, and hardware to connect two of the half-rack receivers side-by-side in one rack space. Multiple receivers can share one pair of antennas via looping connectors on the back of the receiver. And optional remote antennas are available.

**Note,** When rack-mounting receivers, it is preferable to keep them – and their associated antennas – toward the top of the rack so that line-of-sight to the transmitters is unobstructed for the best range and performance. Also, keep receivers and equipment such as digital signal processors, computers, WiFi wireless routers, and other devices that emit RF energy as separated from each other as possible.

Rack Mounting One Receiver with Front-Mounted Antennas



To rack-mount a single XD-V75 receiver, use both the long and short rack ears provided with the receiver; the receiver can be mounted on either the left or right side of the rack. If you are not using optional remote antennas, you will be mounting the provided half-wave antennas on the long rack ear. Remove the rubber covers to expose the D-cut mounting holes in the rack ear, unthread the hex nut and lock washer from the provided BNC-to-BNC connectors, pass them through the holes, and rethread and tighten. Use the four provided short flat-head screws to attach the right-angle tabs of the rack ears in the dovetail slots at the front of the receiver.

To connect the antennas to the receiver, attach one end of the provided BNC cables to **ANTENNA A** and **ANTENNA B** on the rear panel, and the other end to the inside-facing side of the BNC-to-BNC connectors on the long rack ear. Complete the process by screwing the assembly into the rack, making your power and audio connections, and placing the half-wave antennas on the connectors on the front of the rack mount.

## Rack Mounting & Antennas – Two Receivers

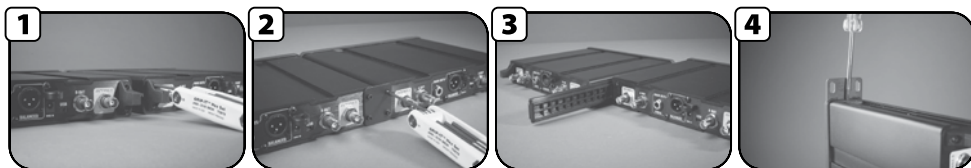

To mount two receivers side-by-side, use the provided “dovetail key”. Slide it into the channel on one side of the receiver from the rear toward the front. The key fits tightly, so some pressure or gentle taps from a mallet may be required; take care to avoid damage to the exposed front-panel controls when positioning the receiver for this process. Then slide the slot of the second receiver on to the dovetail key, starting at the point where the key is closest to the front of the first receiver, and push back until the front panels of the receivers meet.

Part of the dovetail key may still be protruding from the back of the receivers, and the mallet can be used to gently tap until it is flush with the rear of the receivers. At the center of the rear panel where the two receivers meet, use a 1/8” Allen wrench to remove the inner rubber “bumpers”, and place the square rack-mount mating bracket onto the unit so that the holes line up with the screw holes in each receiver. Replace the rubber bumpers and attach with the screws you removed.

Use the short flat-head screws to attach short rack ears to both sides of the block of two receivers. When the receivers are mounted together, either use remote antennas on one receiver and BNC-to-BNC cables to loop to the other.

To loop from one receiver to the next, the antennas connect to the **ANTENNA A** and **ANTENNA B** BNC connector or the rear panel of the first receiver. Then the BNC-to-BNC cables go from the [A OUT] and [B OUT] connectors to the **ANTENNA A** and **ANTENNA B** connectors of the next receiver.

**Note,** For best performance, Line 6 recommends that no more than four receivers share a single pair of antennas via looping through the BNC ports on the rear of the receiver. For the next group of four receivers, use another pair of antennas. Alternately, use a Line 6 antenna distribution unit or other RF distribution unit that is appropriate to the 2.4 GHz band to run multiple receivers from one pair of antennas.

**Note,** Line 6 remote antennas are active and therefore require power through the coaxial antenna cable to function properly. Make sure that any other RF distribution unit that is used can provide the necessary power; consult the antenna specifications for details.

## Remote Antenna Placement

The XD-V75 Digital Wireless system can be used with remote antennas, so that the receivers can be located where convenient – even at a distance from where the transmitters are being used – yet the antennas can be placed nearer to the transmitters for better RF reception. Remote antennas become important especially when the distance is significant between the transmitters and receivers, there are walls or other obstacles between them, or when the receivers are “permanently” mounted in an equipment room or production vehicle and the transmitters are used at various and changing locations and distances. Both omnidirectional and directional (cardioid) remote antennas are available.

To connect remote antennas to receivers, use low-loss 50-ohm coaxial cable with the appropriate BNC connector on each end. Place the antennas with clear line-of-sight to the location where the transmitters will be used; the Line 6 model P360 omnidirectional and P180 directional active antennas provide the convenience of mic stand mounting. Attach one end of the cable to the antenna, and run it the shortest possible distance to the **ANTENNA A** / **ANTENNA B** connectors on the back of the receiver.

Measure the distance and set the gain to the appropriate setting on the antenna; 6 dB for 25 feet, 15 dB for 50 feet, and 26 dB for 100 feet. Once connected and with the receiver on, confirm that the blue light on the front of the antenna is lit. Walk-test the area after the antennas are placed to make sure that it is properly covered without interference or dropouts. Up to three additional receivers can use this antenna by looping the receivers.

**Note,** As the RF signal travels through the cable to the receiver, there will be some loss of signal level, which at greater lengths and with higher loss cables can be significant. With a passive antenna, use the lowest loss cable you can find and try not to exceed about 15 feet of length. With an active antenna that provides additional gain, set it to the proper amplification for the cable length, and try not to exceed 100 feet of cable.

When used properly, remote antennas can increase range and lessen dropouts and interference conditions, compared with having the half-wave antennas directly connected to the receiver or front-mounted in the rack. This is especially true when the receivers must be located in a non-line-of-sight position or behind obstacles.

Omnidirectional antennas are best applied when the users will be transmitting from a wider area – in front, to the sides, and even behind the antenna. Directional antennas provide greater signal strength at the front of the antenna, and greater rejection of the signal at the rear – in the case of the P180, a cardioid coverage pattern of approximately 90 degrees with a roll off to the sides. Use them when the users are in a more confined area or not roaming as much. They can also be used to minimize an interfering signal source by facing the back of the antenna toward the interferer and the front toward the transmitters.

In some cases remote antennas can also allow you to use the transmitter’s low power setting to minimize interference when transmitters are used very close together or two or more groups of transmitters are used for separate productions that are closely located (such as in adjacent ballrooms or theatres). Just make sure that the improved signal strength you receive from a closer and clearer position to the transmitters is not overwhelmed by the losses of too long a cable run.

# APPENDICES

## Troubleshooting

Problem	Solution
<b>No Audio</b>	Switch on transmitter and/or receiver Change transmitter batteries Confirm proper polarity of batteries in transmitter Transmitter audio muted; press MUTE button to unmute Transmitter and receiver are on different channels; set to same channel Transmitter encrypted and receiver not (or with different encryption code) Receiver currently in Channel Scan or Channel Select mode Receiver not connected to audio system, or audio system off or muted
<b>Transmitter Stays On</b>	Transmitter locked; unlock and then turn off
<b>Shorter Range</b>	Antennas not connected to receiver; check connections Receiver antennas not in line-of sight; raise them or clear obstructions Interference from other source; change channel and see Near / Far in manual Place receiver / receiver antennas farther from WiFi or other 2.4 GHz source
<b>Signal Dropouts</b>	Too great a distance between transmitter and receiver; move them closer Switch transmitter to HI power mode Remote the antennas closer to transmitter Keep receiver / antennas higher in line-of-sight; no doors or walls obstructing

## Firmware Updating Procedure

The XD-V75 receiver features a USB port, which may be used for updating the firmware of both the receiver and transmitter when new versions are released. This procedure is detailed on the Line 6 website ([www.line6.com](http://www.line6.com)).

The XD-V75 receiver can be used to update the XD-V70 generation of transmitters to enhance their feature set and compatibility with the XD-V75 receiver, and can also update the CPU in the XD-V70 receiver (as well as the XD-V30, Relay™ G30, Relay™ G50, and Relay™ G90 receiver and transmitters). When using both XD-V70 and XD-V75 units in the same installation, it is recommended to upgrade the older units to the latest firmware. Details are also on the web site.

## Channel RF Frequency Chart

The following chart shows the frequencies used by Channels 1 through 14. Each channel uses two frequencies for greater reliability and redundancy. These frequencies are compatible with each other, and chosen to work within an environment where WiFi is running. For best performance, do not place receivers or transmitters in close proximity to WiFi routers or computers.

Channel	Frequency A	Frequency B	Compatibility
1	2425	2475	Compatible with WiFi 1, 6, & 11
2	2422	2472	Compatible with WiFi 1, 6, & 11
3	2402	2450	Compatible with WiFi 1, 6, & 11
4	2447	2478	Compatible with WiFi 1, 6, & 11
5	2428	2453	Compatible with WiFi 1, 6, & 11
6	2430	2461	Compatible with WiFi 1
7	2433	2467	Compatible with WiFi 1
8	2436	2469	Compatible with WiFi 1
9	2413	2456	Compatible with WiFi 6
10	2416	2458	Compatible with WiFi 6
11	2407	2464	Compatible with WiFi 6
12	2405	2439	Compatible with WiFi 11
13	2419	2444	Compatible with WiFi 11
14	2410	2442	Compatible with WiFi 11

The following chart shows the WiFi channels, with the most commonly used Channels 1, 6, and 11 highlighted.

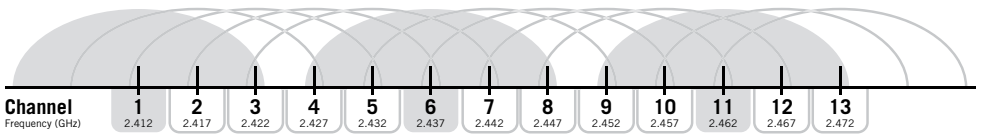

# XD-V75 Digital Wireless System Specifications

## System

Frequency Band	2.4GHz ISM Band
Compatible Channels	14
True Diversity	Yes
Frequency Diversity	Yes (2 Frequencies per channel)
Compander-Free Design	Yes
Frequency Response THD %	10 Hz (-0.5 dB) - 20kHz (-2.5 dB) 0.03% typical
System Latency	< 2.9 ms (audio input to output)
Operating Temp Range	1 – 50 degrees C
<b>Construction</b> XD-V75 Receiver THH12 & TBP12 Transmitters	Extruded aluminum chassis Metal enclosures

## Receiver

Receiver Gain Control	0 dB nominal; -18 to +12 dB range
RF Performance Monitoring	Yes (via LCD screen and LED)
Scanning and Channel Management	Yes (via LCD screen and function menu)
RF Signal Strength Indicators	5-Segment LED
Audio Level Meter (on Receiver)	5-Segment LED
Dynamic Filter	Yes (selectable)
Squelch & Pad adjustments	None required
Number of Receiver Antennas	2
Receiver Format	1/2 RU (with included rack-mount kit)
Receiver Power Requirements	9Vdc 500mA
Output Impedance	XLR: 150 Ohms Balanced 1/4": 1 kOhm Unbalanced
Sensitivity	-95 dBm
Image Rejection	56 dB
Antenna Distribution	A and B In & Out BNC Connectors
Antenna Impedance	50 Ohms

## Transmitters

Transmitter RF Output Power	10 mW HI; 3.3 mW LO
Battery Life	8 hours
<b>Mic Modeling</b> THH12 Handheld TBP12 Beltpack	Yes (10 selectable models) Yes (9 selectable EQ filters)
Batteries	2 x AA Alkaline
Battery Display (on Transmitter)	LCD Screen
<b>Dynamic Range</b> THH12 Handheld TBP12 Beltpack	>115 dB >120 dB
TBP12 Maximum Audio Input Level	6.5 V <sub>pp</sub>
TBP12 Beltpack Input Impedance	1.3 M Ohms
TBP12 Beltpack Supplied Bias Voltage	5 VDC (on Pin 2 of TA4F Connector)
Transmitter Audio Polarity	Positive pressure on mic diaphragm produces positive voltage

### TBP12 Beltpack Pinout To TA4F Connector

Use the following wiring protocol when using other headset, lavalier, or instrument microphones or cables with the TBP12 beltpack transmitter.

- TA4 pinout
- 1 = GND
- 2 = V+
- 3 = Signal
- 4 = Z (This pin is tied to Signal for lav mics and tied to Gnd or open for gtr)





## Free Manuals Download Website

<http://myh66.com>

<http://usermanuals.us>

<http://www.somanuals.com>

<http://www.4manuals.cc>

<http://www.manual-lib.com>

<http://www.404manual.com>

<http://www.luxmanual.com>

<http://aubethermostatmanual.com>

Golf course search by state

<http://golfingnear.com>

Email search by domain

<http://emailbydomain.com>

Auto manuals search

<http://auto.somanuals.com>

TV manuals search

<http://tv.somanuals.com>