

## MegaCode Series



**MDR, MDR2, MDRNR,  
MDRM, MDRM2**

## DIGITAL RECEIVERS

### Installation Instructions

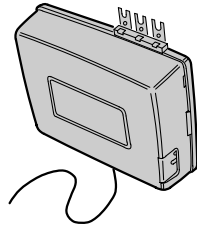

**Linear**

(800) 421-1587 • www.linearcorp.com

## DESCRIPTION

The MegaCode series of digital receivers are wireless radio controls designed for use with automatic garage door and gate openers. The MegaCode radio format provides unparalleled security. The transmitter and receiver can be programmed to more than a million different codes.

MegaCode receivers and transmitters do not contain a typical "coding switch". Each transmitter is pre-set at the factory to a unique code. The receiver is programmed by sending a signal to it from the transmitter(s) that are going to be used with it. This stores the transmitters code into the receiver's memory. The receiver will retain its memory even without power. The receiver will activate only from these "memorized" transmitters. **Each MegaCode receiver can remember a maximum of 10 transmitters.**

Receivers are normally powered with 24 volts AC/DC from the garage door or gate operator. Two-channel receivers provide wire connections to activate the operator's light or control other devices.

**MDR** - Single-channel external receiver with relay output.

**MDRM** - Single-channel internal receiver (fits operators with recessed receivers) with solid state output.

**MDRNR** - Single-channel external receiver with solid state output.

**MDR2** - Two-channel external receiver with relay outputs.

**MDRM2** - Two-channel internal receiver (fits operators with recessed receivers) with solid state output on channel one and relay output on channel two.

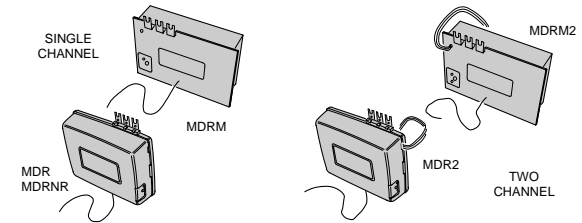

**STEP 1A MDR/MDRNR/MDR2 Three-terminal Operator Installation.** Hold receiver up to back of operator. Connect Terminals 1, 2 & 3 on the receiver to Terminals 1, 2 & 3 on the operator.

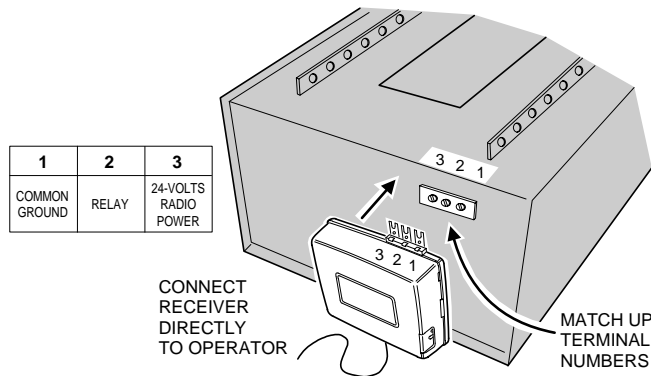

**STEP 1B MDRM/MDRM2 Recessed Receiver Operator Installation.** Loosen operator terminal screws. Install receiver into operator "pocket". Connect Terminals 1, 2 & 3 on the receiver to Terminals 1, 2 & 3 on the operator.

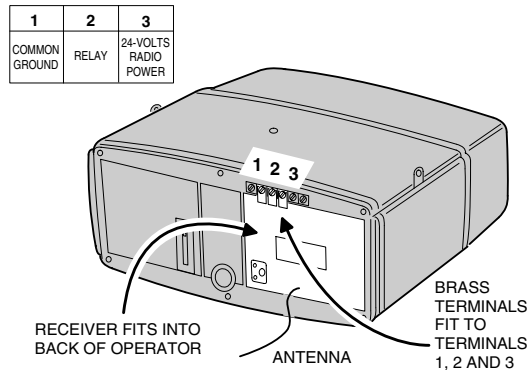

**STEP 1C MDR/MDR2 Two-terminal Operator Installation.** The Model TF524 step-down transformer must be used to power the receiver when connecting to a two-terminal operator or one that supplies other than 24V. Install the screws supplied into the brass terminals on the receiver. Connect the transformer wires to Terminals 1 & 3 (polarity not important). Connect receiver Terminals 1 & 2 to the two operator terminals (polarity not important).

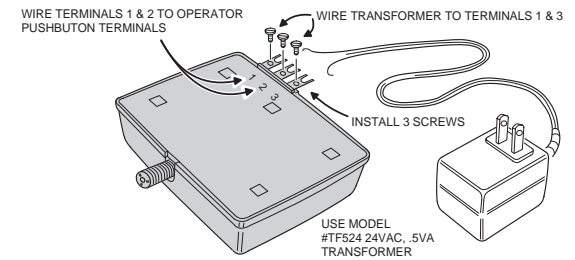

**STEP 2 MDR2/MDRM2 Two-channel Receiver Installation.** Connect the receiver to the operator as described in the previous step. The channel-two pigtail wires can be connected to the operator's light toggle terminals or to an external device.

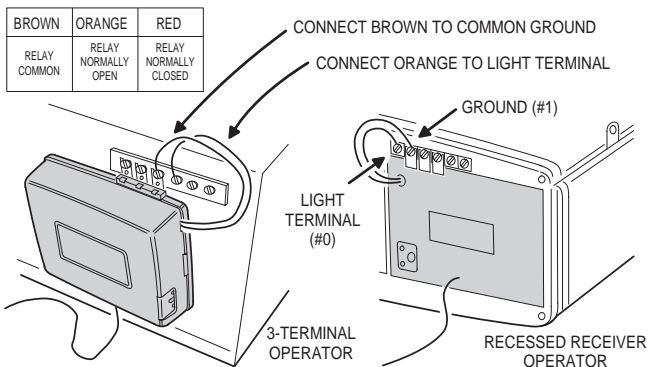

**STEP 3 Optional Receiver Mounting Bracket.** If the receiver isn't going to be mounted directly to the operator terminals, an optional mounting bracket is supplied. It can be installed three ways onto the MDR or MDR2 case. Screw the bracket to a wall or stud and snap the receiver onto it.

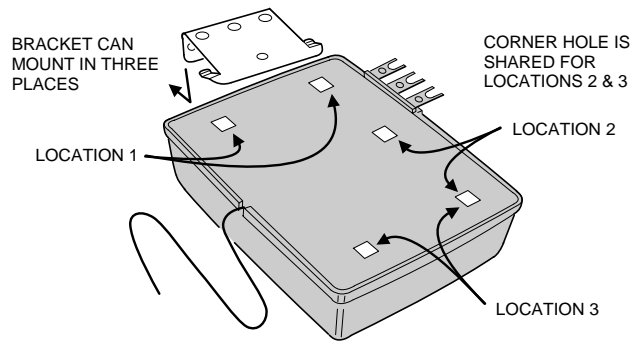

**STEP 4A MDR/MDRNR/MDR2 Program button and LED Location.** Locate the program button and LED on the side of the receiver case.

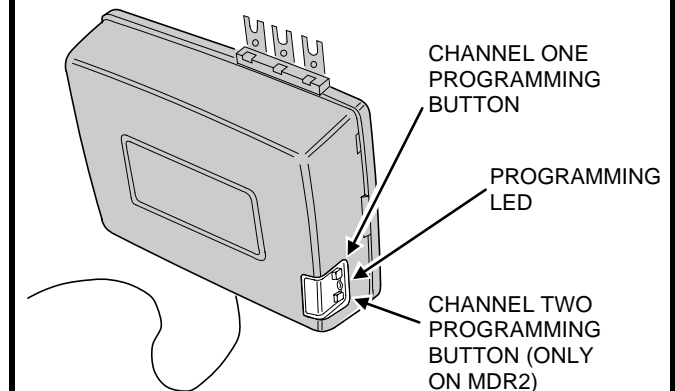

**STEP 4B MDRM/MDRM2 Program button and LED Location.** Locate the program button and LED on the back of the receiver case.

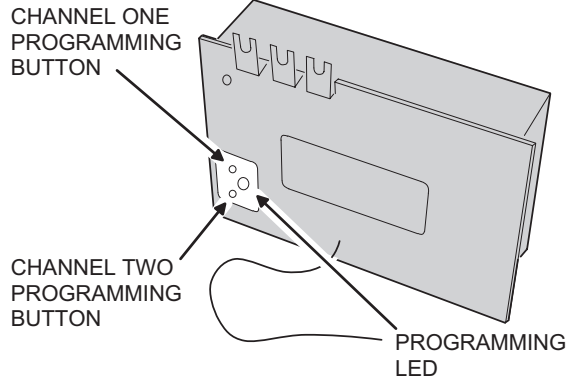

**STEP 5 Program receiver.** Momentarily press the receiver's program button (channel one or two). The red programming LED will light if there's room in the receiver's memory for another transmitter (10 maximum per receiver). The LED stays on for about 5 seconds. **A transmitter must be entered while the LED is on.** Press the desired transmitter button. The LED will flicker indicating that the receiver has accepted the transmitter.

➔ **NOTE:** Be sure to press the receiver program button for less than 2 seconds (any longer may erase memory.)

➔ **WARNING! Door operator will not activate when the receiver is being programmed from the transmitter, but the door operator will activate the next time the transmitter is activated after programming.**

➔ **NOTE:** The programming LED also monitors radio signals entering the receiver. It is common to see an occasional blink from the LED. The LED will also light when any transmitter tuned to the receiver's frequency (programmed into the receiver or not) is activated.

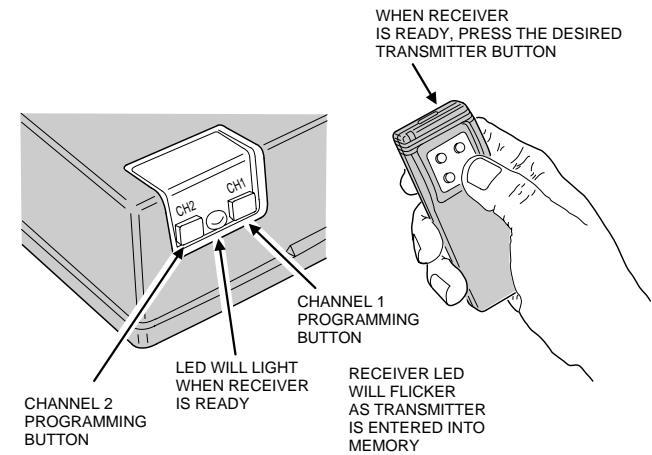

**STEP 6 Add additional transmitters.** Repeat Step 5 for each transmitter used with this receiver. **Be sure to press the receiver's program button each time a new transmitter or a different transmitter button on a multi-button transmitter is pressed.**

If the LED doesn't come on when the receiver's program button is pressed, the receiver's memory is full (10 transmitters total). Use the erase function (Step 9) to remove transmitters from the receiver's memory.

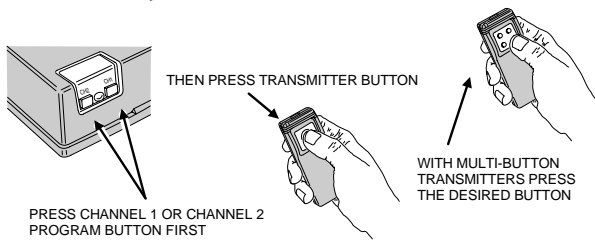

**STEP 7 Review memory.** Press and hold the receiver's program button (channel one or two) until the LED begins to flash (about 3 seconds) and then release the button. Count the number of flashes. The number of flashes equals the number of transmitters programmed into that channel of the receiver.

➔ **NOTE:** Don't hold down the programming button longer than 5 seconds, the receiver's memory for that channel will be erased (Step 9).

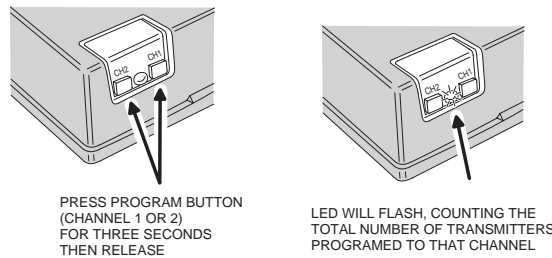

**STEP 8 Test receiver.** Be sure door area is clear. Activate each transmitter. The receiver relay should click (relay output models only) and the operator should activate. **Wait 1 second between each activation.**

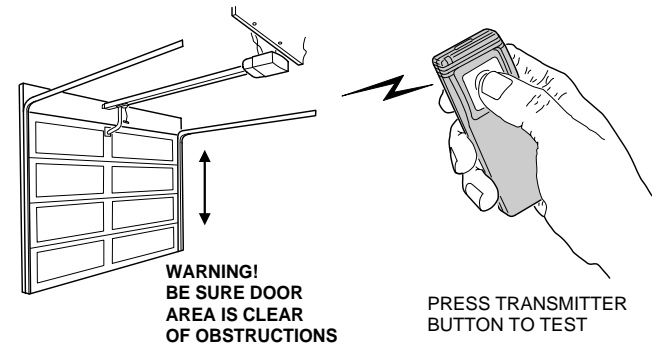

**STEP 9 Erasing receiver memory.** Transmitters may be erased from the receiver's memory by pressing and holding the receiver's program button (channel one or two) for 5 seconds or more. After the LED blinks (count of transmitters) it will blink one more time for channel one and twice for channel 2 as the receiver's memory for that channel is erased. **All transmitters for each receiver channel are erased at the same time.**

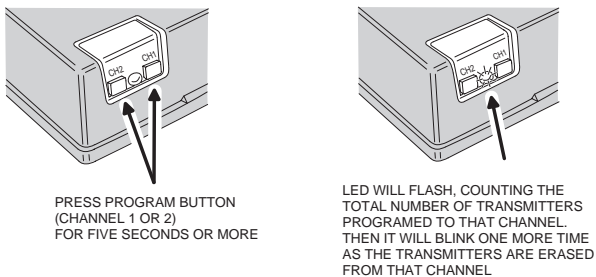

➔ **NOTE:** The same transmitter (or the same transmitter button on multi-button transmitters) cannot be programmed into both receiver channels one and two.

➔ **NOTE:** If the receivers LED flashes continuously when a transmitter isn't being activated, the receiver is too close to an electrical noise source. Move the receiver away from the noise source or call technical services for assistance.

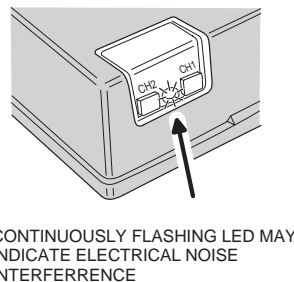

### LIMITED WARRANTY

This product is warranted to the consumer against defects in material and workmanship for one year from the date of purchase. This warranty applies to first retail buyers of new devices. Warrantor will repair, or at its option, replace, any device it finds that requires service under this warranty, and will return the repaired or replaced device to the consumer at the warrantor's cost. For warranty service and shipping instructions contact warrantor at the address shown below. Devices must be sent to warrantor for service at owner's expense. The remedies provided by this warranty are exclusive. Implied warranties under state law are to the one year period of this written warranty. Some states do not allow limitations on how long an implied warranty lasts, so the above limitation may not apply to you. In order to be protected by this warranty, save your proof of purchase and send copy with equipment should repair be required. This warranty gives you specific legal rights, and you may also have other rights which vary from state to state.

All products returned for warranty service require a Return Product Authorization Number (RPA#). Contact Linear Technical Services at 1-800-421-1587 for an RPA# and other important details.

### IMPORTANT !!!

Linear radio controls provide a reliable communications link and fill an important need in portable wireless signaling. However, there are some limitations which must be observed.

- \* For U.S. installations only: The radios are required to comply with FCC Rules and Regulations as Part 15 devices. As such, they have limited transmitter power and therefore limited range.
- \* A receiver cannot respond to more than one transmitted signal at a time and may be blocked by radio signals that occur on or near their operating frequencies, regardless of code settings.
- \* Changes or modifications to the device may void FCC compliance.
- \* Infrequently used radio links should be tested regularly to protect against undetected interference or fault.
- \* A general knowledge of radio and its vagaries should be gained prior to acting as a wholesale distributor or dealer, and these facts should be communicated to the ultimate users.

## Free Manuals Download Website

<http://myh66.com>

<http://usermanuals.us>

<http://www.somanuals.com>

<http://www.4manuals.cc>

<http://www.manual-lib.com>

<http://www.404manual.com>

<http://www.luxmanual.com>

<http://aubethermostatmanual.com>

Golf course search by state

<http://golfingnear.com>

Email search by domain

<http://emailbydomain.com>

Auto manuals search

<http://auto.somanuals.com>

TV manuals search

<http://tv.somanuals.com>