

Operation and Installation Manual

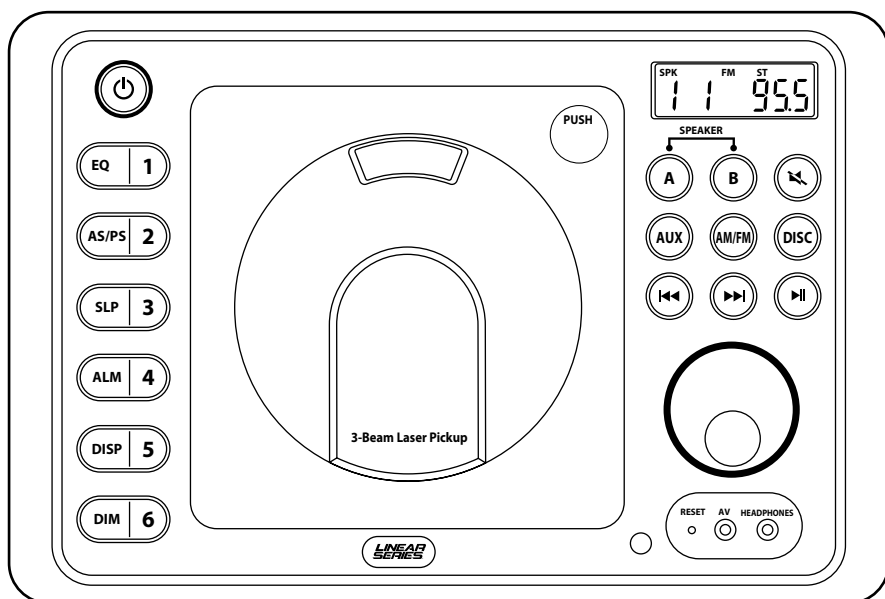

RV4500 AM / FM Stereo Multi-Media Receiver

Introduction

Please take the time to read all of the information in this manual. Familiarity with operation and installation procedures will help you obtain the best possible performance from your new AM/FM Stereo Multi-Media Receiver.

WARNING! To prevent fire or electrical shock hazard, do not expose this product to moisture, or remove cover or bottom screws. No user-serviceable parts inside. Refer servicing to qualified personnel.

Index

Button Locations and Functions	3-4
Remote Control Button Locations and Functions	5
General Operation	6
Sound Controls	6-8
Speaker Selection	8
Setting the Clock	8-9
Sleep Timer Operation	9
Alarm Operation	10
Radio Operations	11-12
Disc Warnings	12
Music Disc Operation	13-14
MP3 Disc Operation	15-16
Movie Disc Operation	17-19
Setup Menu	20
Audio/Video Input	21
Headphone Output	21
Reset Button	22
Additional Features	22
Installation	23
Speaker Connections	24
Wiring and Auxiliary Connections	25
Safety Instructions	26
Warranty	27

Button Locations and Functions

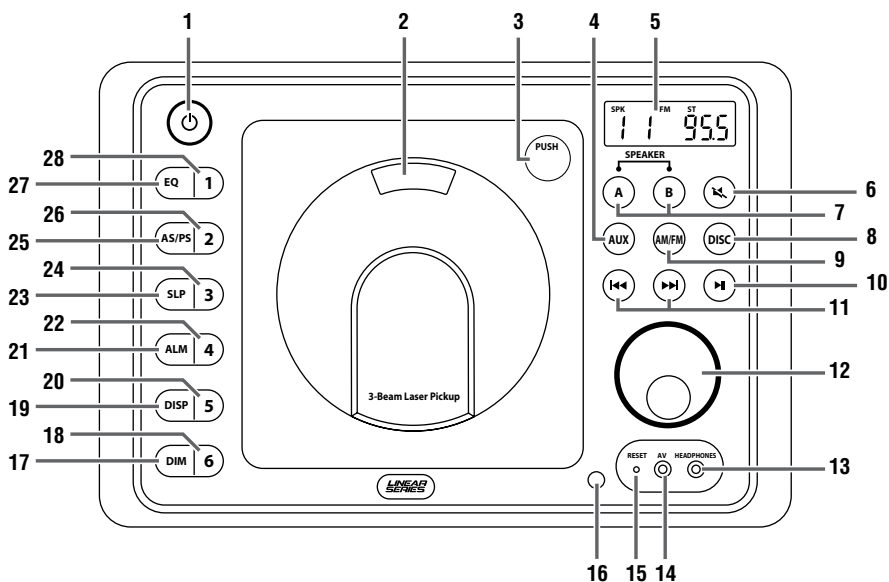

1. **Power On/Off:** Press to turn the unit on or off.
2. **Disc Door:** To play a disc, insert the disc with label facing forward.
3. **Disc Door Release:** Press to open the door so the disc can be inserted.
4. **Auxiliary Button (AUX):** Press to choose between Av In F (Audio/Video in Front), Av In R (Audio/Video in Rear)
5. **Display Area:** This area displays all function information for the radio, clock, disc player and auxiliary input devices.
6. **Mute Button:** Press to mute the audio, press again to restore the audio.
7. **Speaker Selection Buttons:** Press to switch the speakers sets A and B on and off.
8. **Disc Button:** Press to select the movie or music player mode.
9. **Radio Button (AM/FM):** Press to select the radio mode. Sequential presses will select radio band: FM 1, FM 2, FM 3, AM 1 and AM 2.
10. **Play/Pause Button (II):** Press to pause disc play, press again to resume play.
11. **Seek Down (I<<), Seek Up (>>I) Buttons:**
Radio Mode: Press to tune the radio to a lower or higher radio station.
Disc Mode: Press to search for the beginning or next track or chapter.
12. **Volume and Select Button:** Rotate to increase or decrease the volume level. Press to select the sound controls: Bass, Treble and Balance.
13. **Headphone Socket:** Accepts 3.5mm stereo headphone jacks.
14. **Audio/Video Input Jack:** Press the **AUX** button until "Av In F" appears in the display then plug in a device via the 3.5mm audio/video input socket.
Note: The RV4500 does not control the device, it just allows the audio/video to be played through the system.

Button Locations and Functions (Continued)

15. **Reset Button:** Press to reset the unit to its default settings.
16. **Infrared Eye:** Receives the signals from the remote control.
17. **Dimmer Button (DIM):** Press to dim the lighting in the display area. Sequential presses will select different levels of display area lighting.
18. **Radio Preset Button (6):** Recalls a memorized radio station, and programs a radio station into memory.
19. **Display Button (DISP):** Press to toggle through the available display information.
20. **Radio Preset Button (5):** Recalls a memorized radio station, and programs a radio station into memory.
21. **Alarm Button:** Sets the alarm. (See "Alarm Operation" for more details).
22. **Radio Preset Button (4):** Recalls a memorized radio station, and programs a radio station into memory.
23. **Sleep Button:** Sets the sleep timer. (See "Sleep Timer Operation" for more details).
24. **Radio Preset Button (3):** Recalls a memorized radio station, and programs a radio station into memory.
25. **Radio AS/PS Button:** Automatic radio station memory storing (AS) and Preset radio station scanning (PS). (See "AM/FM Operation" for more details).
26. **Radio Preset Button (2):** Recalls a memorized radio station, and programs a radio station into memory.
27. **EQ/LOUD Button (Equalizer and Loudness):** Press to select between the preset sound equalization settings. Press and hold the button to boost high and low tones at low volume levels (loudness).
28. **Radio Preset Button (1):** Recalls a memorized radio station, and programs a radio station into memory.

Remote Control Button Locations and Functions

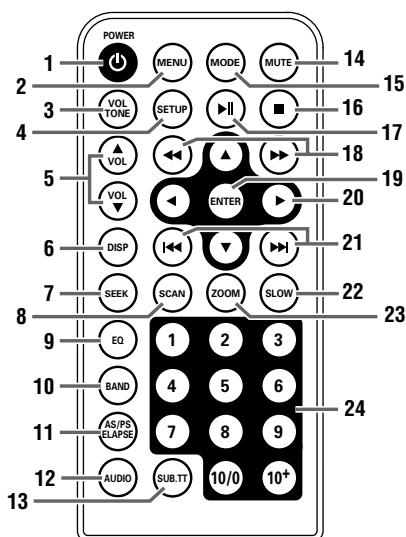

1. **Power On/Off Button (⏻):** Press to turn the unit on or off.
2. **Menu Button:** Press to access the Menu screen in movie mode.
3. **Sound Control Button (VOL/TONE):** Press to select the sound controls: Bass, Treble and Balance.
4. **Setup Button:** Displays the on-screen SETUP menu.
5. **Volume Buttons (VOL ▲ / VOL ▼):** Press VOL ▲ to increase or VOL ▼ decrease the volume level.
6. **Display Button (DISP):** Press to toggle through the available display information.
7. **Radio SEEK Button:** Press and the tuner will seek up to the next strong station and stop.
8. **Radio SCAN Button:** Press this button and the tuner will scan up to the next strong station, pausing for 10 seconds at each station. Press the button again to cancel the scan function.
9. **Equalizer/Loudness Button (EQ):** Press to select between the preset sound equalization settings. Press and hold the button to boost high and low tones at low volume levels (loudness).
10. **Band Button:** Press to select the radio mode. Sequential presses will select radio band: FM 1, FM 2, FM 3, AM 1 or AM 2.
11. **AS/PS Elapse Button:**
 - Radio:** Automatic radio station memory storing (AS) and Preset radio station scanning (PS). (See "AM/FM Operation" for more details).
 - Disc:** Press to display movie information.
12. **Audio Button:** Press to select appropriate movie audio/language setup.
13. **Subtitle Button (SUB.TT):** Press to access the movie disc's subtitle languages.
14. **Mute Button:** Press to mute the volume level. Press again to restore the volume.
15. **Mode Button:** Press to select between the different modes: Radio, Disc and Auxiliary Input.
16. **Stop Button (■):** Press to stop disc play.
17. **Play/Pause Button (▶||):** Press to pause disc play, press again to resume play.
18. **Backwards (◀◀) or Fast Forward (▶▶)**
 - Disc Play:** Press ◀◀ and "BACKWARD X 2" appears in the display and the disc will play backwards at 2 times the normal speed. Press again and "BACKWARD X 4" will appear. X8 and X20 speeds can also be selected. Fast Forward ▶▶ button works the same way but fast forward. Press the ▶|| button at any time to resume normal play.
19. **Enter Button:** Executes the selected item.
20. **Navigation Buttons (▲, ▼, ◀, ▶):** Moves feature selection up, down, left or right.
21. **Down (◀◀), Up (▶▶) Buttons:**
 - Radio Mode:** Press to manually tune the radio to a lower or higher frequency.
 - Disc Mode:** Press to search for the beginning or next track or chapter.
22. **Slow Button:** Press to play the movie in slow motion.
23. **Zoom Button:** Press to enlarge or reduce the movie's on-screen image.
24. **Numeric Buttons (1, 2, 3, 4, 5, 6, 7, 8, 9, 10/0 and 10+)**

General Operations

Power On/Off:

Press the **POWER** button to turn the unit On/Off.

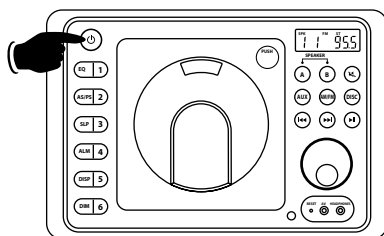

Selecting a Play Source:

To select a play source, press one of the following mode buttons:

AUX (Auxiliary Input Front or Rear),

AM/FM (AM or FM Radio Band) or

DISC (Music or Movie)

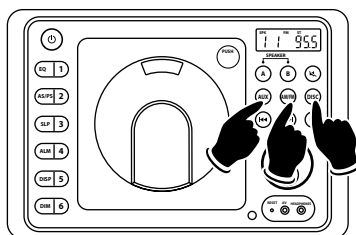

Dimming the Display:

Press the **DIM** button to select the desired level of brightness for the display area.

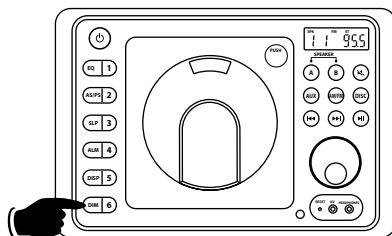

Display Selection:

Press the **DISP** button to display the clock.

Press again to return to previous display.

Press and hold to perform clock setting functions (See "Setting the Clock" for more details).

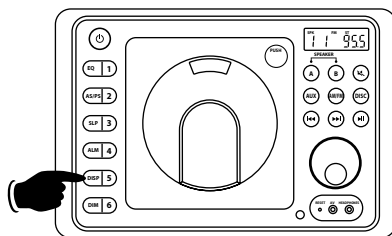

Sound Controls

Volume:

Increase the volume by rotating the **VOLUME** knob clockwise. Decrease the volume by rotating the **VOLUME** knob counterclockwise.

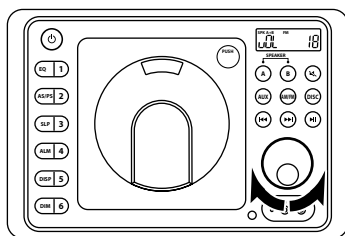

Sound Controls

Bass, Treble and Balance Control

Select the desired sound mode by pressing the **VOLUME** knob. The modes will be displayed in the following order: Bass, Treble, Balance and Volume.

Bass:

Select the Bass mode by pressing the **VOLUME** knob. Increase the Bass by rotating the **VOLUME** knob clockwise. Decrease the Bass by rotating the knob counterclockwise. After 6 seconds control reverts back to volume control.

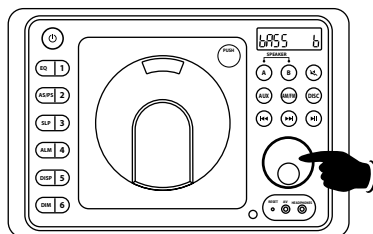

Treble:

Select the Treble mode by pressing the **VOLUME** knob. Increase the Treble by rotating the **VOLUME** knob clockwise. Decrease the Treble by rotating the knob counterclockwise. After 6 seconds control reverts back to volume control.

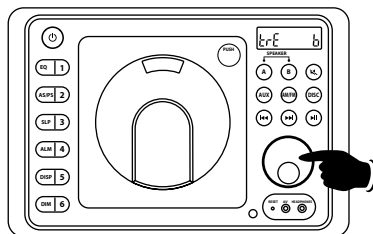

Balance:

Select the Balance mode by pressing the **VOLUME** knob. Adjust the Balance by rotating the knob.

- r = L = Equal sound right and left
- r = Right speaker only
- L = Left speaker only

After 6 seconds control reverts back to volume control.

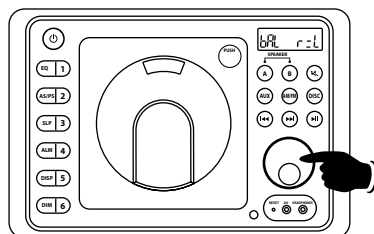

Equalizer (EQ):

Press the **EQ** button to choose between the preset equalizer settings: Flat, Classic, Rock, Pop and Jazz as indicated in the display area.

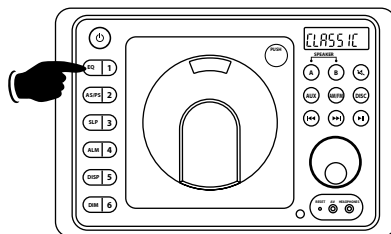

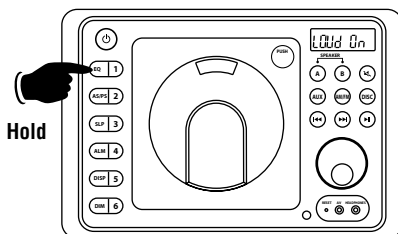

Loud:

To boost high and low tones at low volume levels, press and hold the **EQ** button until "LOUD On" appears in the display. To deselect, press and hold the **EQ** button again until "LOUD OFF" appears in the display.



Sound Controls (Continued)

Mute:

- Press the  button to mute the volume level.
- Press the  button again to restore the volume.

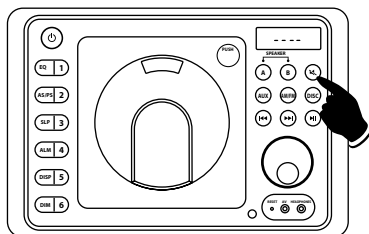

Speaker Selection

Selecting Speaker Sets:

- Press the **A** button to toggle speaker set A on and off. "SPK A" appears in the display when speaker set A is on.
- Press the **B** button to toggle speaker set B on and off. "SPK B" appears in the display when speaker set B is on.

Note: When "SPK A+B" appears in the display both speaker sets A and B are on. When nothing appears in the displaying both speaker sets are off.

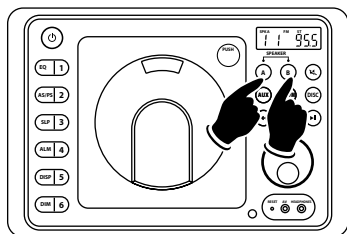

Setting the Clock

1. Press the **DISP** button until the clock appears in the display.

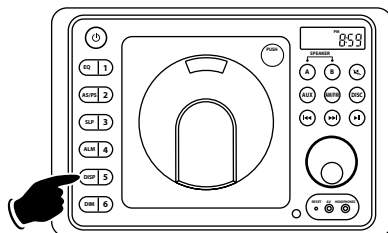

2. Press and hold the **DISP** button until the hours number starts flashing.

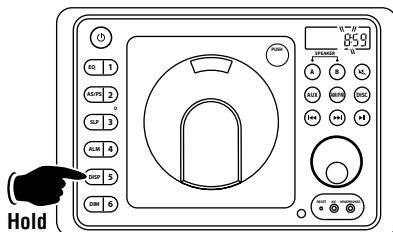

3. Rotate the **VOLUME** knob until the correct Hour appears in the display.

Note: When setting the clock make sure to select the correct AM or PM indicator.

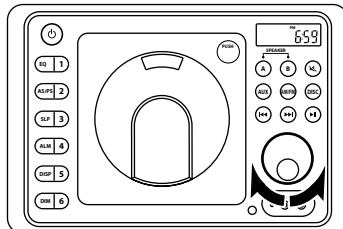

Setting the Clock (Continued)

4. Press the **VOLUME** knob and the Minute indicators will start flashing.

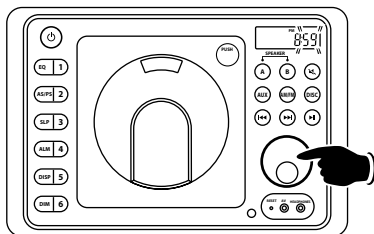

5. Rotate the **VOLUME** knob until the correct Minutes appears in the display. Wait 5 seconds and the colon between the hours and the minutes will start flashing indicating the clock is set.

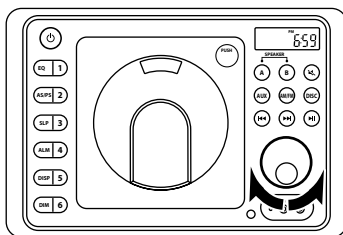

Sleep Timer Operation

Setting the Sleep Timer:

1. Press the **SLP** button until the "SLP 10" appears in the display.
2. Keep pressing the **SLP** button again until the desired sleep time appears in the display (00, 10, 20, 30, 40, 50, 60, 70, 80 minutes).
3. Wait 5 seconds and the display will return to normal operation and "SLP" will appear in the display.
4. After the designated sleep timer has expired the unit will turn off automatically.

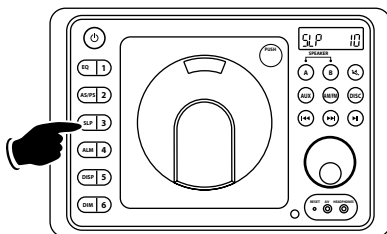

Cancelling the Sleep Timer:

1. Press the **SLP** button until "00" is displayed.
2. Wait 5 seconds and the display will return to normal operation.

Alarm Operation

Setting the Alarm Timer:

1. Press the **ALM** button and the clock will appear in the display with the hour number flashing.

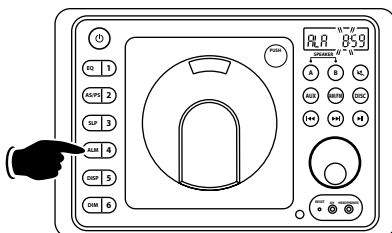

2. Rotate the **VOLUME** knob until the correct Hour appears in the display. "ALM" will appear in the display indicating the alarm is activated.

Note 1: When setting the alarm clock make sure to select the correct AM or PM indicator.

Note 2: When setting the alarm DO NOT use 12:00 AM, because that time is used to cancel the alarm.

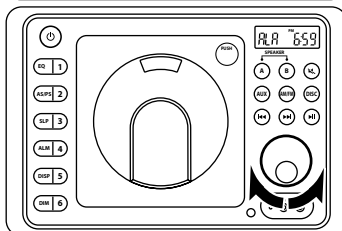

3. Press the **VOLUME** knob and the minute indicators will start flashing.

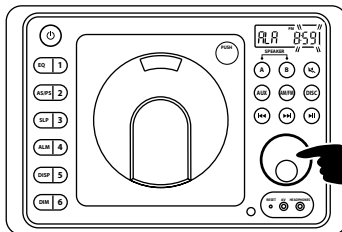

4. Rotate the **VOLUME** knob until the correct minutes appears in the display. Wait 5 seconds and the colon between the hours and the minutes will start flashing. The letter "ALM" will appear in the display indicating the alarm is set.

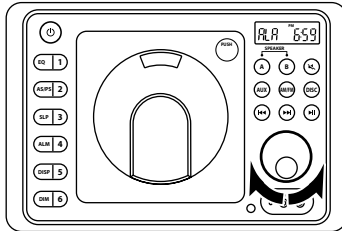

5. Press the **POWER** button to turn the unit off. The unit will automatically turn on when the set alarm time is reached.

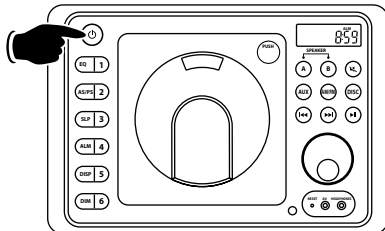

Cancelling the Alarm Timer:

Follow the procedures above except set the alarm time to 12:00 AM. When the display exits alarm timer programming the "ALM" will disappear from the display indicating the alarm has been cancelled.

Radio Operations

Selecting the Play Source:

Press the **AM/FM** button and “rAdIO” appears in the display. After a brief moment either AM or FM will appear in the display.

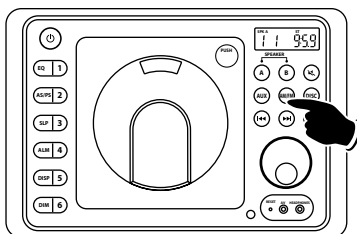

Selecting the AM or FM:

Press the **AM/FM** button repeatedly and select from FM 1, FM 2, FM 3, AM 1 or AM 2.

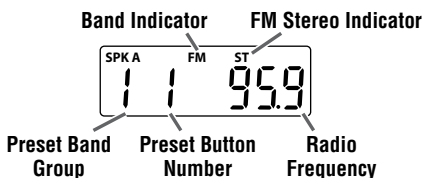

Seek Tuning in a Radio Station:

Press and release the **I◀◀** button to tune in a lower radio station. Press and release the **▶▶I** button to tune in a higher radio station.

Note: The unit will automatically switch from FM Mono to FM Stereo when the signal strength increases to a stereo level. If the stereo signal should become weak, the unit will switch back to Mono. FM stereo reception is indicated when “ST” appears in the display.

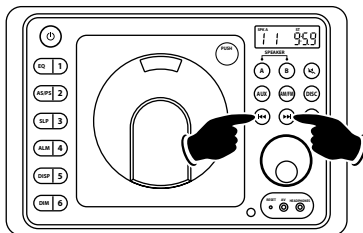

Manual Tuning in a Radio Station:

Press and hold the **I◀◀** button to manually tune in a lower radio frequency. Press and hold the **▶▶I** button to manually tune in a higher radio frequency.

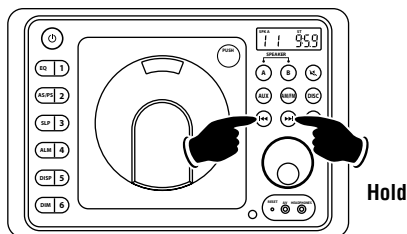

Memorizing Radio Stations:

1. Press the **AM/FM** button to select either the FM 1, FM 2, FM 3, AM 1 or AM 2 radio band.
2. Tune-in the desired radio station.
3. To memorize the station press and hold any one of the six radio station recall buttons until the preset number appears.

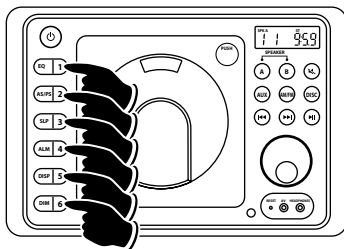

Radio Operation (Continued)

Automatically Store Radio Stations:

1. Press the **AM/FM** button to select either the FM or AM radio band.
2. Press and hold the **AS/PS** button then release. The tuner will search for the strongest stations and store them into memory. The new stations will replace stations that were previously stored in the current band.

Note: When the FM band is selected the 18 strongest stations will be stored. When AM band is selected the 12 strongest stations will be stored.

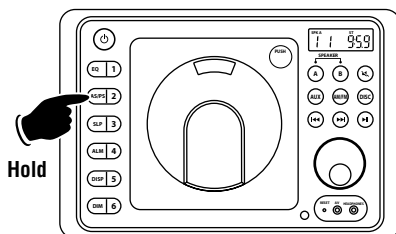

Scanning Stored Radio Stations:

1. Press the **AM/FM** button to select either the FM or AM radio band.
2. Press the **AS/PS** button then release. The tuner scans for preset stations stored in the current band and pauses for 6 seconds at each station. When a desired station is reached, press the **AS/PS** button again to stop scanning.

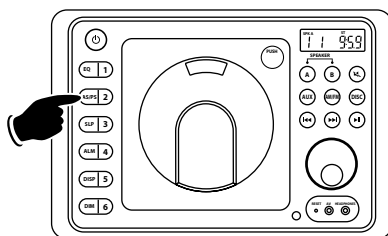

Disc Warnings

Handling and Cleaning:

- Dirt, dust, scratches and warping disc will cause non operation.
- Do not place stickers on disc or scratch disc.
- Do not warp discs.
- A disc should always be kept in its case when not in use to prevent damage.
- Do not place discs in the following places:
 1. Direct sunlight.
 2. Dirty, dusty and damp areas.
 3. Near car heaters.
 4. Car seats or dashboard.

Disc Cleaning:

Use a dry soft cloth to wipe disc the surface. If the disc is quite dirty, use a soft cloth slightly moist with isopropyl (rubbing) alcohol. Never use solvents such as benzene, thinner or conventional record cleaners as they may mar the surface of the disc.

Note: A disc may become somewhat scratched (although not enough to make it unusable) depending on handling and conditions in the usage environment.

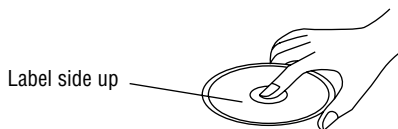

Do not touch the underside of the disc



Do not bend



Wipe the disc from the center toward the outside edge

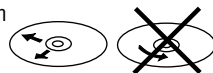

Music Disc Operation

General Operations:

1. Push the door access the disc player.

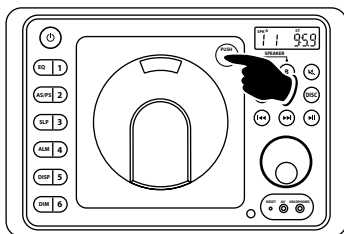

2. Insert the disc onto the hub with the label facing forward. Use your thumb to make sure the disc snaps onto the hub.



3. Press the **DISC** button and "LOADing" will appear in the display. The disc will automatically start playing.

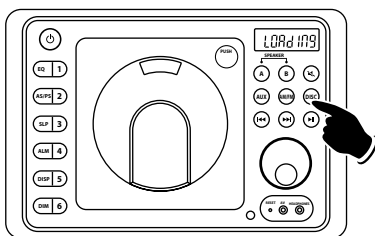

Music Track Selection:

Press the **1◀◀** button to select a lower track. Press the **▶▶1** button to select a higher track. The track number will appear in the display.

Tracks can also be selected by using the remote control. Press the track selection number button that corresponds to the track you want to play.

For example: If you want to play track 8, press button **8**. Track 8 will start playing and "8" will appear in the display.

If you want to play track 12, press button **10+**, followed immediately by button **2**. Track 12 will start playing and "12" will appear in the display.

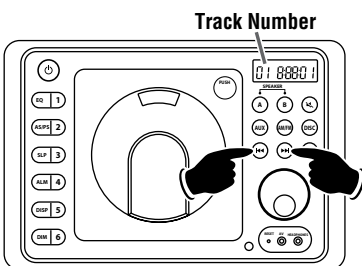

Music Disc Operation (Continued)

Pausing the Disc:

Press the **▶||** button on the remote control to pause the disc, press it again to resume play.



Stopping the Disc:

Press the **■** button to stop the disc. To resume play, press the **▶||** button.

Pressing the **■** button 2 times, then pressing the **▶||** button will play the disc from the beginning.

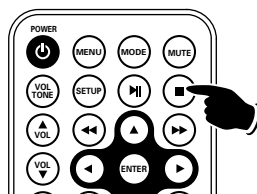

Removing the Disc:

1. Push the door to access the disc player. Wait until the disc stops spinning before opening the door.
2. Use your finger to remove the disc from the hub.
3. Close the door.

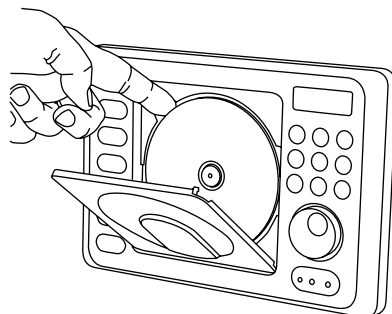

Elapse Times:

Continue to press the **AS/PS** button during music disc play to display the following disc information in this order:

Single Elapse, Single Remain, Total Elapse and Total Remain.

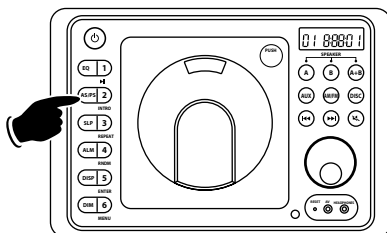

MP3 Disc Operation

General Operations:

1. Push the door access the disc player.

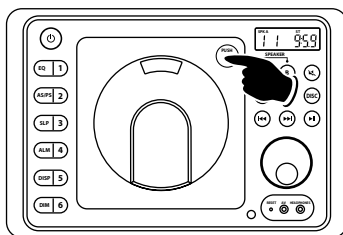

2. Insert the disc onto the hub with the label facing forward. Use your thumb to make sure the disc snaps onto the hub.

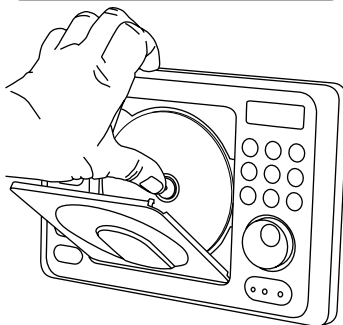

3. Press the **DISC** button and "LOADing" will appear in the display. The disc will automatically start playing.

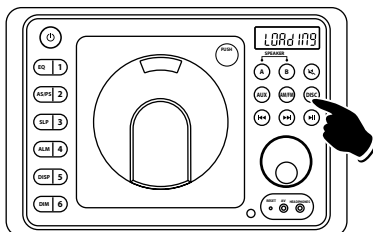

Disc File Selection:

Press the **I◀◀** button to select a lower file.
Press the **▶▶I** button to select a higher file.
The file number will appear in the display.

Files can also be selected by using the remote control. Press the file selection number button that corresponds to the file you want to play.

For example: If you want to play file 8, press button **8**. File 8 will start playing and "8" will appear in the display.

If you want to play file 12, press button **10+**, followed immediately by button **2**. Track 12 will start playing and "12" will appear in the display.

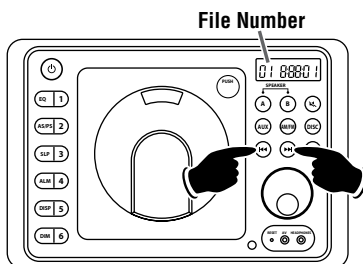

MP3 Disc Operation (Continued)

Pausing the Disc:

Press the ►|| button on the remote control to pause the disc, press it again to resume play.



Stopping the Disc:

Press the ■ button to stop the disc. To resume play, press the ►|| button.

Pressing the ■ button 2 times, then pressing the ►|| button will play the disc from the beginning.

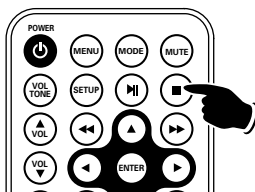

Removing the Disc:

1. Push the door to access the disc player. Wait until the disc stops spinning before opening up the door.
2. Use your finger to remove the disc from the hub.
3. Close the door.

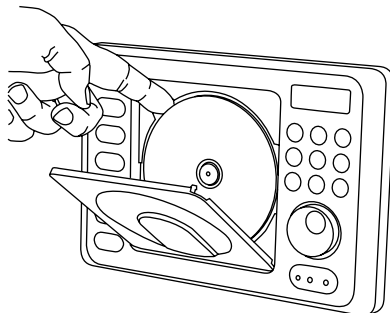

Movie Disc Operation

General Operations:

1. Push the door access the disc player.

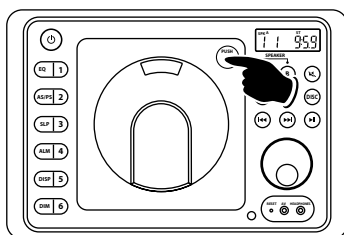

2. Insert the disc onto the hub with the label facing forward. Use your thumb to make sure the disc snaps onto the hub.

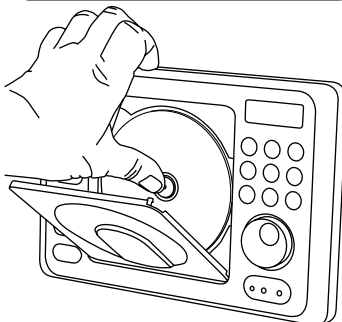

3. Press the **DISC** button and "LOADing" will appear in the display. The disc will automatically start playing.

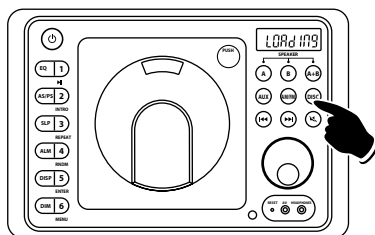

Menu Function:

1. Press the **MENU** button during disc play and the main menu will be displayed.
2. Scroll through the menu with the **NAVIGATION BUTTONS** (▲, ►, ▼, ◀) on the remote control.
3. Select a feature by pressing the **ENTER** button.

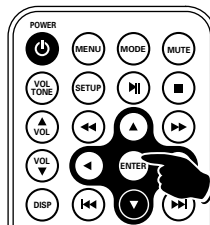

Movie Disc Operation (Continued)

Pausing the Movie

Press the **⏸** button on the remote control to pause the movie, press it again to resume play.

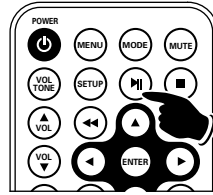

Stopping a Movie:

Press the **■** button on the remote control to stop the movie. To resume play, press the **⏸** button.

Pressing the **■** button 2 times. Then pressing the **⏸** button and the movie will start playing from the beginning.



Movie Chapter Selection:

Press the **⏮** button to select a lower chapter. Press the **⏭** button to select a higher chapter. The chapter number will appear in the display.

Chapter selection can also be selected by using the remote control. Press the chapter selection number button that corresponds to the chapter you want to play.

For example: If you want to play chapter 8, press button **8** button.

If you want to play chapter 28, press the **10+** button twice followed immediately by button **8**. Chapter 28 will start playing and "28" will appear in the display.

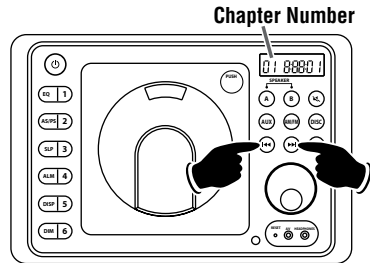

Fast Forward / Backwards Movie Play:

Press the **⏩** (fast forward) or **⏪** (backwards) button on the remote control during play. Each time the button is pressed the speed of fast forward/ backwards changes in the following order: 2X, 4X, 8X, 20X

To resume normal play, press the **⏸** (Play) button.



Movie Disc Operation (Continued)

Slow Motion:

Continue to press the **SLOW** button to play the movie is slow motion in the following order:

SF 1/2, SF 1/3, SF 1/4, SF 1/5, SF 1/6, SF 1/7,
SB 1/2, SB 1/3, SB 1/4, SB 1/5, SB 1/6, SB 1/7

To resume normal play, press the **▶||** (Play) button.

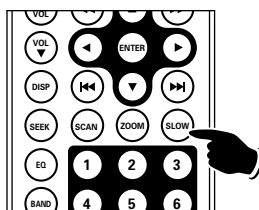

Zooming the Image:

To enlarge the on-screen image during disc play, press the **ZOOM** button. Each time the button is pressed, the magnification increment changes in the following order:

2X, 3X, 4X, 1/2, 1/3, 1/4.

Use the navigation buttons to move the image on the screen.

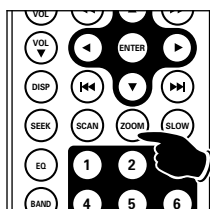

EIapse Times:

Continue to press the **AS/PS ELAPSE** button during movie play to display the following information in this order for most discs:

Title Elapse, Title Remain, Chapter Elapse,
Chapter Remain and Display Off.

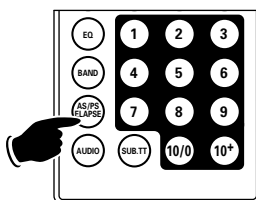

Subtitle Language Menu:

Press the **SUB.TT** button during playback. Each time the button is pressed, the subtitle language changes in sequential order.

- Some discs may only contain one subtitle language.
- Depending on the disc, the number of subtitle languages may be different.

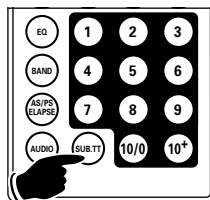

Audio Language Menu:

Press the **AUDIO** button during playback to review the current setting. Most movies have their own audio setup. Go to the on-screen menu to select appropriate audio/language setup.

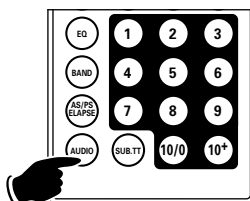

Setup Menu

Accessing the Movie Disc Setup Menu:

Press the **SETUP** button on the remote control to display the Setup Menu.

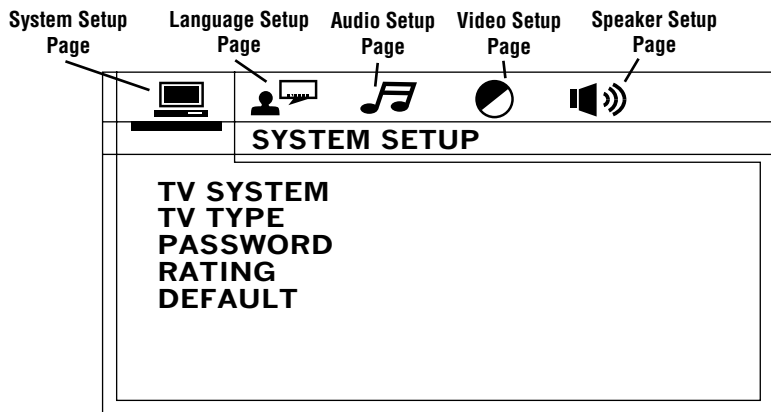

System Setup Page:

Use the navigation buttons to scroll between the menu items. Make a selection by pressing the **ENTER** button.

- TV System: NTSC, PAL or Auto.
- TV Type: 4:3PS, 4:3LB or 16:9.
- Password: _ _ _ _
- Rating: 1 Kid Safe, 2 G, 3 PG, 4 PG13, 5 PG-R, 6 R, 7 NC-17, 8 Adult.
- Default: Restore

Language Setup Page:

Use the navigation buttons to scroll between the menu items. Make a selection by pressing the **ENTER** button. Language Setup Options:

- OSD Language: English or Spanish.
- Audio Lang: Chinese, English, Japan, French, Spanish, Portuguese, Latin or German.
- Subtitle Lang: Chinese, English, Japan, French, Spanish, Portuguese, German or Off.
- Menu Lang: Chinese, English, Japan, French, Spanish, Portuguese, German or Latin.

Audio Setup Page:

Use the navigation buttons to scroll between the menu items. Make a selection by pressing the **ENTER** button. Audio Submenu Options:

- Audio Out: SPDIF/OFF, SPDIF/Raw or SPDIF/PCM.

Video Setup Page:

Use the navigation buttons to scroll between the menu items. Make a selection by pressing the **ENTER** button. Video Submenu Options:

- Brightness: 12, 10, 8, 6, 4, 2 or 0.
- Contrast: 12, 10, 8, 6, 4, 2 or 0.
- Hue: +6, +4, +2, 0, -2, -4 or -6.
- Saturation: 12, 10, 8, 6, 4, 2 or 0.
- Sharpness: 8, 6, 4, 2 or 0.

Digital Setup Page:

Use the navigation buttons to scroll between the menu items. Make a selection by pressing the **ENTER** button. Digital Submenu Options:

- Dynamic Range: Full, 6/8, 4/8, 2/8 or Off.
- Dual Mono: Stereo, Mono L, Mono R or Mix Mono.

Audio/Video Input

Selecting the Audio/Video Play Source:

Note: The RV4500 does not control the device, it just allows the audio/video to be played through the system.

Front Audio/Video Input:

Insert the 3.5mm jack from the audio/video device into the AV input socket on the front of the housing. Press the **AUX** button until “Av In F” appears in the display. Refer to the audio/video device’s owner’s manual for proper operation.

Rear Audio/Video Input:

To select the rear input Audio/Video play source, press the **AUX** button until “Av In r” appears in the display. Refer to the audio/video device’s owners manual for proper operation.

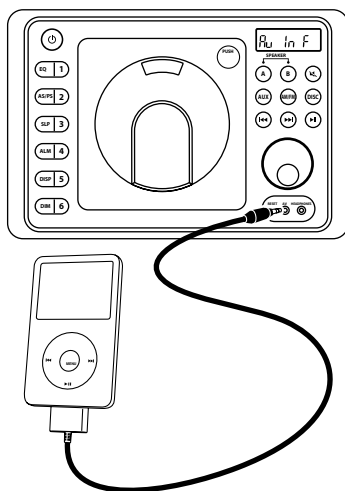

Headphone Output

Plugging in Headphone:

Insert a 3.5mm headphone jack into the Headphone Output socket. Use the volume knob on the headphone to adjust the audio level.

Note: To make it so the sound only can be heard through the headphones press speaker buttons **A** and **B** until neither “SPK A” or “SPK B” appears in the display.

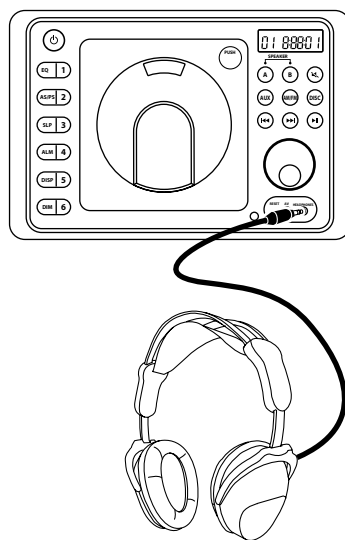

Reset Button

The LCD display may fail to function normally due to the vehicle's battery condition, and could require resetting the radio microprocessor if:

- The vehicle has been "jump started" from a dead battery condition.
- The vehicle battery becomes very low and is quick-charged.
- The vehicle battery is removed and replaced.

Should any of these conditions occur, simply press and release the **RESET** button on the radio front panel using the tip of a ball point pen. This will reset the radio microprocessor to the original factory settings. After pressing the **RESET** button you should recheck to see if the radio functions normally.

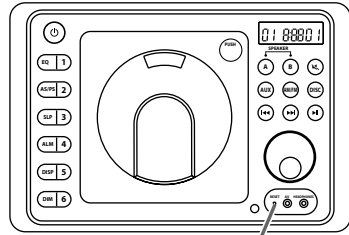

Reset Button

Additional Feature

Area Radio Frequency Adjustment:

Note: If operating the unit in the USA do not change the area.

To Change the Area:

1. Press the **AM/FM** button and "rAdIO" appears in the display.
2. Press and hold the **VOL/TONE** knob until "SEtUP" appears in the display.
3. Press the **▶||** button and "US" or "OCEAn" will be displayed.
4. Press the **◀◀** or **▶▶** button to change the setting to "US" or "OCEAn".
5. Press the **▶||** button to save the setting. The unit will clear all the station settings. After waiting a few seconds the unit exit programming.

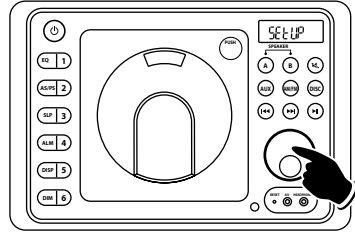

Installation

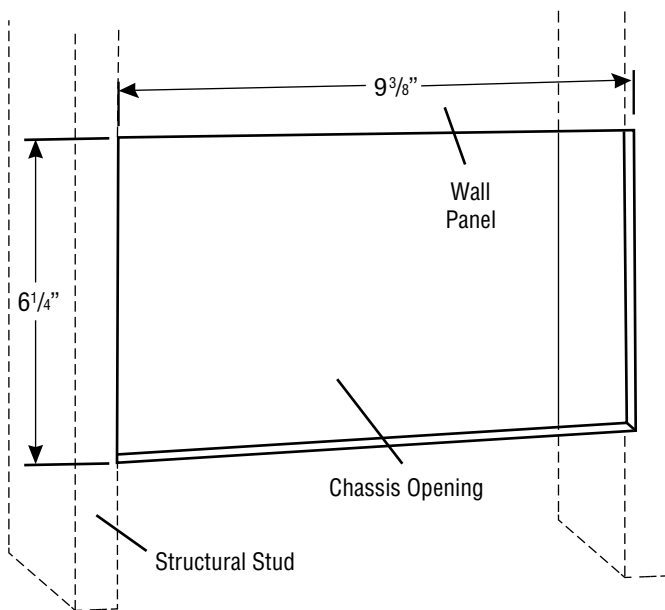

Caution: Do not install radio without rear cover installed: No user-serviceable parts inside. Rear cover provides protection against potential fire hazard.

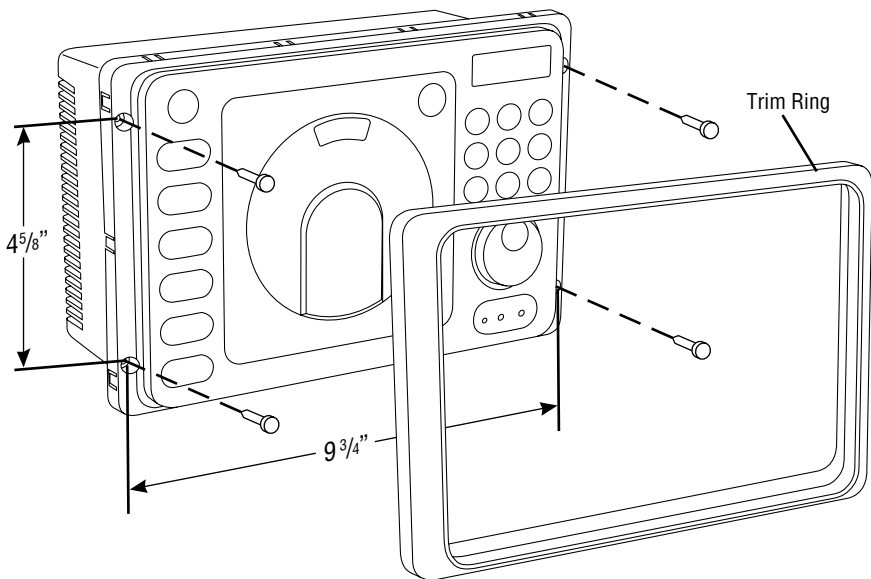

Speaker Connections

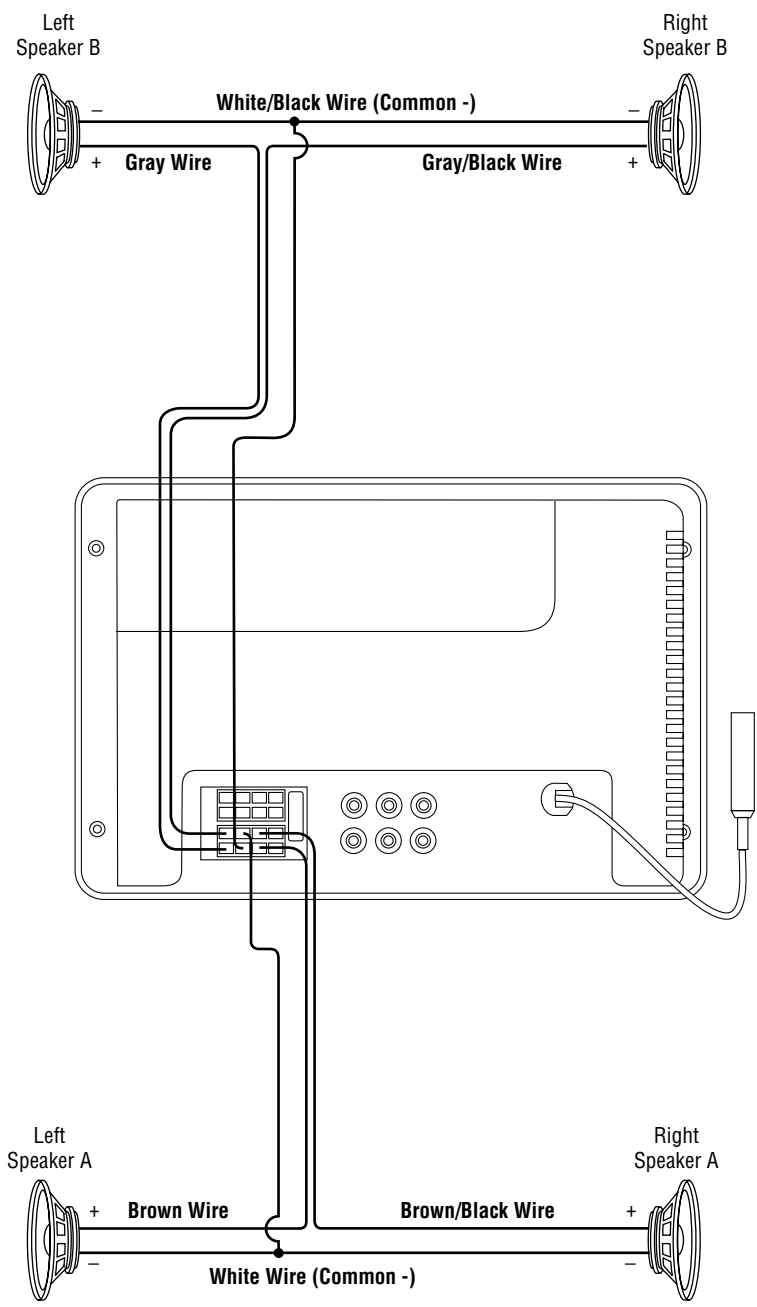

Wiring and Auxiliary Connections

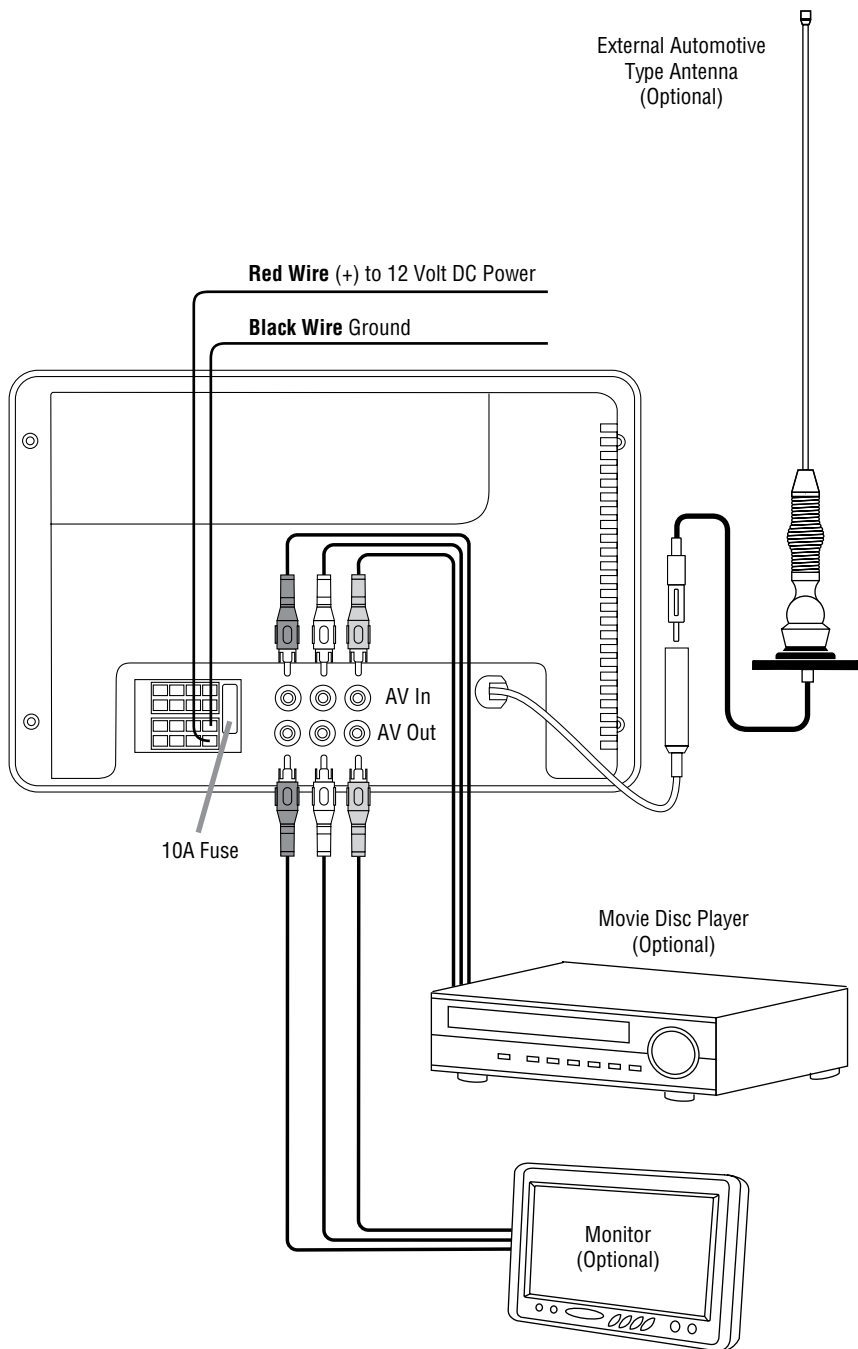

Safety Instructions

- **Read Instructions:** All the safety and operating instructions should be read before the appliance is operated.
- **Retain Instructions:** The safety and operating instructions should be retained for future reference.
- **Heed Warnings:** All warnings on the appliance and in the operating instructions should be adhered to.
- **Follow Instructions:** All operating and use instructions should be followed.
- **Water and Moisture:** The appliance should not be used near water. For example, near a bathtub, wash-bowl, kitchen sink, laundry tub, in a wet basement, or near a swimming pool, etc.
- **Wall or Cabinet Mounting:** The appliance should be mounted to a wall or cabinet only recommended by the manufacturer.
- **Heat:** The appliance should be situated away from heat sources such as radiators, heat registers, stoves, or other appliances (including amplifiers) that produce heat.
- **Power Supply:** The appliance should be connected to a power supply only of the type described in the operating instructions or as marked on the appliance.
- **Power Lines:** An outdoor antenna should be located away from power lines.
- **Object and Liquid Entry:** Care should be taken so that objects do not fall, and liquids are not spilled into the enclosure through openings.

Outdoor Antenna Grounding:

If an outside antenna is connected to the receiver, be sure the antenna system is grounded, so as to provide some protection against voltage surges and built up static charges. Section 810 of the National Electrical Code, ANSI/NFPA No. 70-1983, provides information with respect to proper grounding of the mast and supporting structure, grounding of the lead-in wire to an antenna discharge unit, size of grounding conductors, location of antenna-discharge unit, connection to grounding electrodes, and requirements for the grounding electrode. See illustration below.

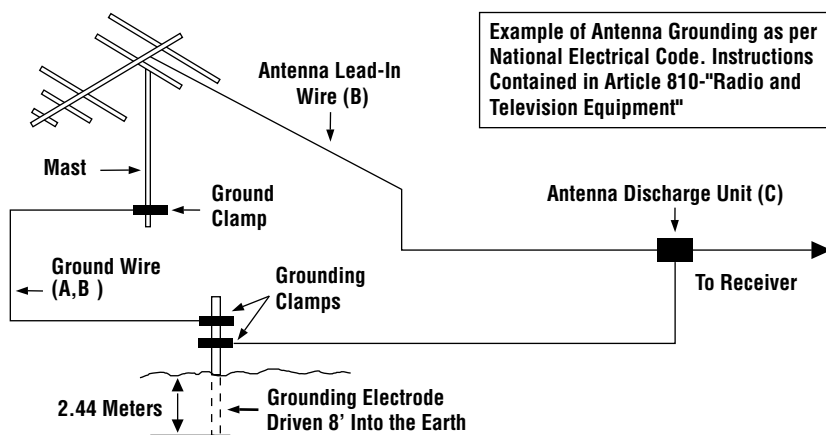

- A. Use No. 10 AWG (5.3mm²) copper, No. 8 AWG (8.4mm²) aluminum, No. 17 AWG (1.0mm²) copper clad steel or bronze wire, or larger as ground wire.
- B. Secure antenna lead-in and ground wires to house with stand-off insulators spaced from 4 feet (1.22m) to 6 feet (1.83m) apart.
- C. Mount antenna discharge unit as close as possible to where lead-in enters house.

ONE (1) YEAR LIMITED WARRANTY

Magnadyne Corporation or its authorized agents will within one year from the date of sale to you, repair, replace or refund the retail sales price of said product or any part thereof, at the option of the Magnadyne Corporation or its authorized agents, if said product or part is found defective in materials or workmanship, when properly connected and operating on the correct power requirements designated for the specific product. This warranty and Magnadyne Corporation or its authorized agent's obligations hereunder do not apply where the product was; damaged while in the possession of the consumer, subjected to unreasonable or unintended use, not reasonably maintained, utilized in commercial or industrial operations, or serviced by anyone other than Magnadyne Corporation or its authorized agents, or where the warning seal on the product is broken or the power and/or plugs are detached from the unit. Magnadyne Corporation or any of its authorized agents will not assume any labor costs for the removal and reinstallation of any product found to be defective, or the cost of transportation to Magnadyne Corporation or its authorized agents. Such cost are the sole responsibility of the purchaser.

This warranty does not cover the cabinet appearance items or accessories used in connection with this product, or any damage to recording or recording tape, or any damage to the products resulting from improper installation, alteration, accident, misuse, abuse or acts of nature.

MAGNADYNE CORPORATION OR ITS AUTHORIZED AGENTS SHALL NOT BE LIABLE TO ANYONE FOR CONSEQUENTIAL OR INCIDENTAL DAMAGES OR CLAIMS EXCEPT THOSE ACCORDED BY LAW. NO EXPRESSED WARRANTY OR IMPLIED WARRANTY IS GIVEN EXCEPT THOSE SET FORTH HEREIN. NO IMPLIED WARRANTY SHALL EXTEND BEYOND ONE YEAR FROM THE DATE OF SALE.

This warranty extends only to the original purchaser of the product and is not transferable. Some states do not allow limitations on how long an implied warranty lasts, and some states do not allow the exclusion or limitation of incidental or consequential damages, so the above limitations or exclusion may not apply to you. This warranty gives you specific legal rights, and you may have other rights that vary from state to state.

“NOTE: The manufacturer is not responsible for any radio or TV interference caused by unauthorized modifications to this equipment. Such modifications could void the User's authority to operate the equipment.”

Defective merchandise should be returned to the original point of purchase or secondly, to Magnadyne Corporation, 1111 W. Victoria Street, Compton CA 90220. Return Authorization must be obtained before sending, or merchandise may be refused.

Free Manuals Download Website

<http://myh66.com>

<http://usermanuals.us>

<http://www.somanuals.com>

<http://www.4manuals.cc>

<http://www.manual-lib.com>

<http://www.404manual.com>

<http://www.luxmanual.com>

<http://aubethermostatmanual.com>

Golf course search by state

<http://golfingnear.com>

Email search by domain

<http://emailbydomain.com>

Auto manuals search

<http://auto.somanuals.com>

TV manuals search

<http://tv.somanuals.com>