

**LINEAR  
SERIES**

# Operation and Installation Manual

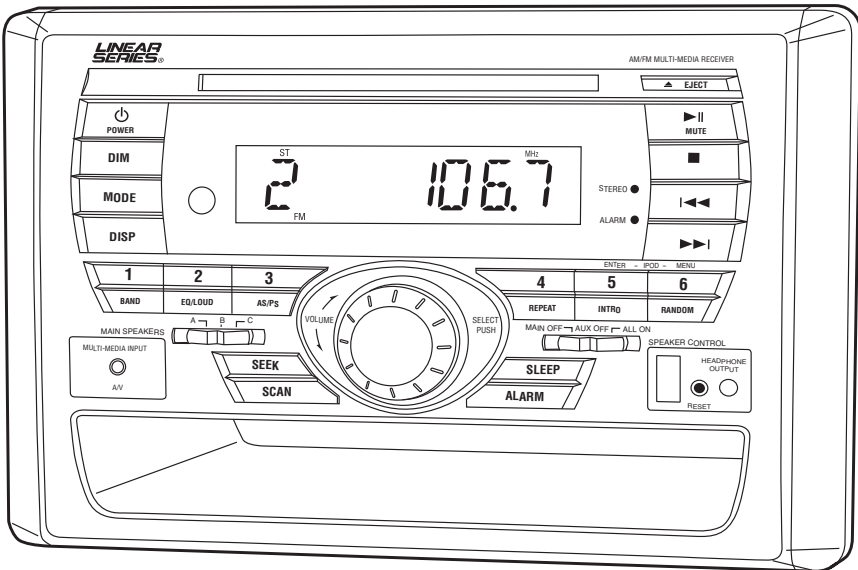

## **RV5060** AM / FM Stereo Multi-Media Receiver

U.S. PATENT NO.: D561754

## Introduction

Please take the time to read all of the information in this manual. Familiarity with operation and installation procedures will help you obtain the best possible performance from your new AM/FM Stereo Multi-Media Receiver.

**WARNING!** To prevent fire or electrical shock hazard, do not expose this product to moisture, or remove cover or bottom screws. No user-serviceable parts inside. Refer servicing to qualified personnel.

## Index

Button Locations and Functions .....	3-4
Remote Control Button Locations and Functions .....	5
General Operation .....	6
Sound Controls .....	7-8
Speaker Selection Switches .....	8-9
Setting the Clock .....	9
Sleep Timer Operation .....	9
Alarm Operation .....	10
Radio Operations .....	11-12
Disc Warnings .....	13
Music Disc Operation .....	14-15
MP3 Disc Operation .....	16
Movie Disc Operation .....	17-19
Setup Menu .....	19-20
Audio Input .....	21
Headphone Output .....	21
IPOD Operations .....	22-24
USB Input .....	25
Reset Button .....	26
Installation .....	27
Speaker Connections .....	28
Auxiliary Connections .....	29
Input Connections .....	30
Safety Instructions .....	31
Warranty .....	32

## Button Locations and Functions

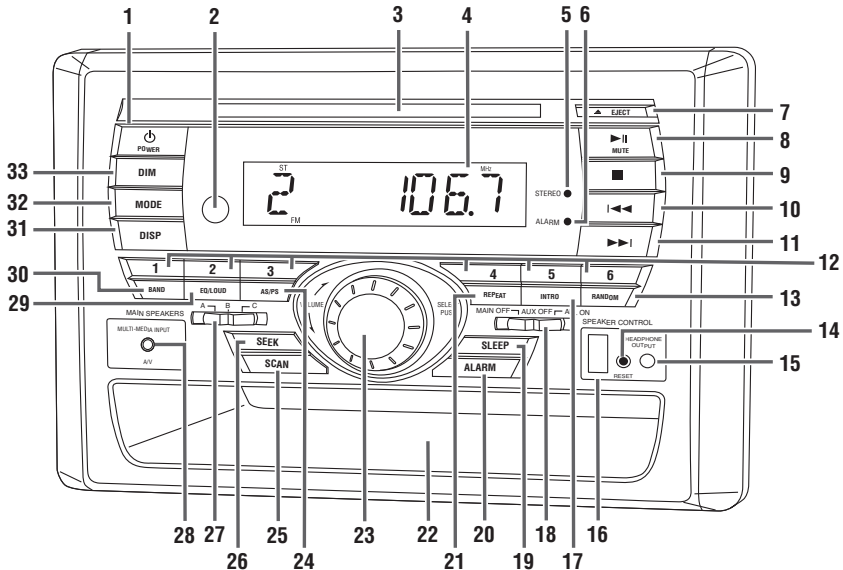

1. **Power On/Off:** Press to turn the unit on or off.
2. **Infrared Eye:** Receives the signals from the remote control.
3. **Disc Slot:** To play a disc, insert the disc into slot with label facing up.
4. **Display Area:** This area displays all function information for the radio, clock, disc player and IPOD.
5. **FM Stereo Indication LED:** FM stereo reception is indicated when the LED is on.
6. **Alarm Timer LED:** The alarm timer has been activated when the LED is on.
7. **Eject Button:** Press to eject the disc.
8. **Play/Pause (▶||) and Mute Button:**  
**Radio and Multi-Media Input Modes:** Press to mute volume level. Press again to restore.  
**Disc Mode:** Press to pause disc play, press again to resume play.  
**IPOD Mode:** Press to pause play, press again to resume play.
9. **Stop Button**  
**Disc Mode:** Press to stop play of movie or audio.
10. **Seek - I◀◀ Button:**  
**Radio Mode:** Press to tune the radio to a lower frequency.  
**Disc Mode:** Press this button to search for the beginning of the previous track or chapter.  
**IPOD Mode:** Press this button to search for the beginning of the previous track.
11. **Seek + ▶▶I Button:**  
**Radio Mode:** Press to tune the radio to a higher frequency.  
**Disc Mode:** Press this button to search for the beginning of the next track or chapter.  
**IPOD Mode:** Press this button to search for the beginning of the next track.
12. **Radio Station Recall Buttons (1-6):** Press and release when recalling preset radio stations. Press and hold until the preset number appears to memorize a radio station.
13. **Random Button:**  
**Disc Mode:** Press to play all the tracks on the music disc in random order. Press again to cancel.
14. **Reset Button:** Press to reset the unit to it's default settings.

## Button Locations and Functions (Continued)

- 15. Headphone Socket:** Accepts 3.5mm stereo headphone jacks.
- 16. USB Input:** Press the **MODE** button (32) until "DISC" appears in the display. Then plug in your USB device. "USB" will then appear in the display.  
**Note:** The RV5060 will control the USB audio device. (See "USB Input" for more details).
- 17. Music Disc Intro Button:** Press to preview each track on the music disc for 6 seconds. Press again to cancel.
- 18. Speaker Control Switch:** Switches the main speakers off/auxiliary speakers on, main speakers on/auxiliary speakers off or main/auxiliary speakers on.
- 19. Sleep Button:** Sets the sleep timer. (See "Sleep Timer Operation" for more details).
- 20. Alarm Button:** Sets the alarm. (See "Alarm Operation" for more details).
- 21. Repeat Button:**  
**Disc Mode:** Press to repeat a music disc track or to repeat a movie disc title or chapter. Press again to cancel.  
**IPOD Mode:** (See IPOD Operations section for more details).
- 22. Storage Tray.**
- 23. Volume and Select Button:** Rotate to increase or decrease the volume level. Press to select the sound controls: Bass, Treble and Balance.  
**IPOD Mode:** (See IPOD Operations section for more details).
- 24. Radio AS/PS Button:** Automatic radio station memory storing (AS) and Preset radio station scanning (PS). (See "AM/FM Operation" for more details).
- 25. Radio SCAN Button:** Press this button and the tuner will scan up, pausing for 5 seconds at each strong station. Press the button again to cancel the scan function.
- 26. Radio SEEK Button:** Press this button and the tuner will scan up to the next strong station and stop.
- 27. Main Speakers A, B and C Selector Switch:** Selects the different sets of speakers installed.
- 28. Audio/Video Input Jack:** Press the **MODE** button until "AV IN F" appears in the display then plug in a device via the 3.5mm audio/video input plug.  
**Note:** The RV5060 does not control the device, it just allows the audio/video to be played through the system.
- 29. EQ/LOUD Button (Equalizer and Loudness):** Press to select between the preset sound equalization settings. Press and hold the button to boost high and low tones at low volume levels (loudness).
- 30. AM/FM Band Selector Button:** Press to select the desired radio band: 1 FM, 2 FM, 3 FM, 1 AM and 2 AM.
- 31. DISP Button (Display):** Press to display the clock or frequency in radio mode, track in music disc mode, chapter and elapse time in movie disc mode or track in IPOD mode. Press and hold to perform clock setting functions (See "Setting the Clock" for more details).
- 32. Mode Button:** Press to choose between AV IN F (Audio/Video in Front), AV IN R (Audio/Video in Rear), RADIO (AM or FM Band), DISC (Music, Movie or USB Input) and IPOD (IPOD Input).
- 33. DIM Button (Display Dimmer):** Press to select the desired level of brightness of the display.

## Remote Control Button Locations and Functions

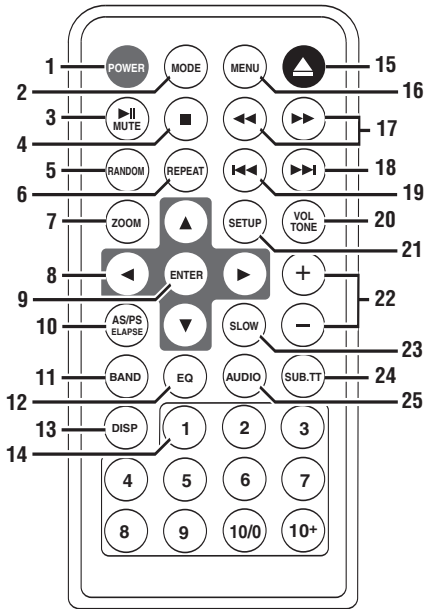

1. **Power On/Off Button:** Press to turn the unit on or off.
2. **Mode Button:** Press to choose between Audio/Video In, Front (AV IN F), Audio/Video In, Rear (AV IN R), AM/FM Radio (RADIO), Music/Movie Disc or USB Input (DISC) and IPOD Input (IPOD)
3. **Play/Pause and Mute Button:**  
**Radio Modes:** Press to mute volume level. Press again to restore.  
**Disc Mode:** Press to pause disc play, press again to resume play.
4. **Stop Button:** Press to stop play of picture or audio.
5. **Random:** Press to play all the tracks on the music disc in random order. Press again to cancel.
6. **Repeat:** Press to repeat a music track or to repeat a movie disc title or chapter. Press again to cancel.
7. **Zoom:** Press to enlarge the movie disc's onscreen image.
8. **Navigation:** In the movie disc menu mode, these buttons serve as cursor buttons to select item left/right, up/down.
9. **Enter:** Executes the selected item.
10. **AS/PS Button:** Automatic radio station memory storing (AS) and Preset radio station scanning (PS). See "Radio Operation" for more details. In music and movie modes press to display running times.
11. **AM/FM Band Selector Button:** Press to select the desired radio band: 1FM, 2FM, 3FM, 1AM, and 2AM.
12. **EQ Button (Equalizer):** Press to select between the preset sound equalization settings.
13. **DISP Button (Display):** Press to display the frequency in radio mode or track in music disc mode and chapter and elapse time in movie disc mode. Press and hold to perform clock setting functions (See "Setting the Clock" for more details).
14. **Numeric Buttons**
15. **Eject Button:** Press to eject a disc.
16. **Menu Button:** Press to display the root menu that is stored on the movie disc.
17. **Fast Forward/Fast Reverse Disc Play Buttons:** Press the ►► button to fast forward disc play or press the ◀◀ button to fast reverse disc play. Each time the button is pressed, the speed changes. To resume normal play, press the ►| (Play) button.
18. **Previous Button:**  
**Radio Mode:** Press to tune to a lower radio station frequency.  
**Disc Mode:** Press this button to search for the beginning of the previous track or chapter.
19. **Next Button:**  
**Radio Mode:** Press to tune to a higher radio station frequency.  
**Disc Mode:** Press this button to search for the beginning of the next track or chapter.
20. **Volume/Tone Button:** Press to select the different sound controls: Volume, Bass, Treble and Balance.
21. **Setup Button:** Displays the onscreen SETUP menu.
22. **Volume Adjustment Buttons:** Press to increase or decrease the volume level. They also adjust Bass, Treble and Balance when selected.
23. **Slow Motion:** Press to play the movie disc in slow motion.
24. **Subtitle Button:** Press to access movie disc's subtitle languages.
25. **Audio Button:** Press to access movie disc's audio setting.

## General Operations

### Power On/Off:

Press the **POWER** button to turn the unit On/Off.

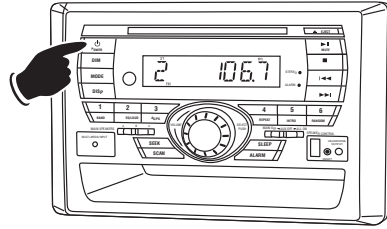

### Selecting a Play Source:

To select a play source, press the **MODE** button until the desired source appears in the display:

- AV IN F** (Audio/Video Input Front),
- AV IN R** (Audio/Video Input Rear),
- RADIO** (AM or FM Band)
- DISC** (Music, Movie or USB Input), and
- IPOD** (IPOD Input) (Optional harness required).

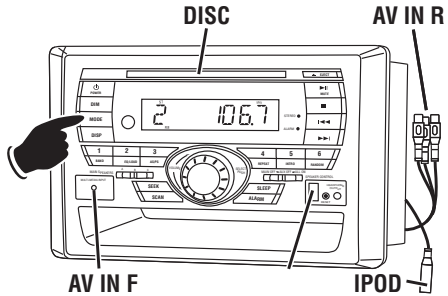

### Dimming the Display:

Press the **DIM** button to select the desired level of brightness for the display.

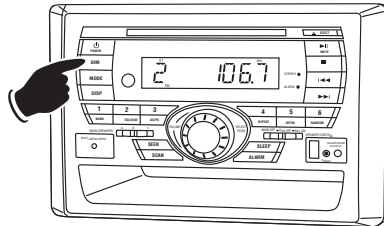

### Display Selection:

Press the **DISP** button to display the clock. Press again to return to previous display.

Press and hold to perform clock setting functions (See "Setting the Clock" for more details).

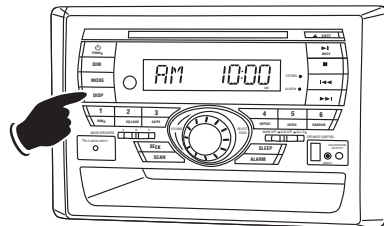

## Sound Controls

### Volume:

Increase the volume by rotating the Volume knob clockwise. Decrease the volume by rotating the Volume knob counterclockwise.

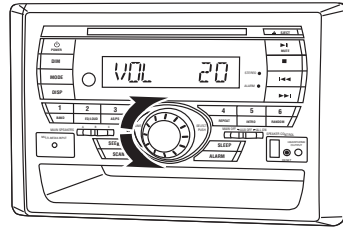

### Bass, Treble and Balance Control

Select the desired sound mode by pressing the **VOLUME/SELECT** knob. The modes will be displayed in the following order: Bass, Treble, Balance and Volume.

### Bass:

Select the Bass mode by pressing the **VOLUME/SELECT** button. Increase the Bass by rotating the knob clockwise. Decrease the Bass by rotating the knob counterclockwise. After 5 seconds control reverts back to volume control.

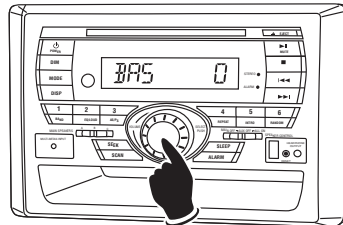

### Treble:

Select the Treble mode by pressing the **VOLUME/SELECT** button. Increase the Treble by rotating the knob clockwise. Decrease the Treble by rotating the knob counterclockwise. After 5 seconds control reverts back to volume control.

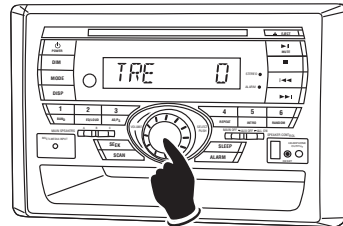

### Balance:

Select the Balance mode by pressing the **VOLUME/SELECT** button. Adjust the Balance by rotating the knob.

- R:L = Equal sound right and left
- R 7 = Right speaker only
- L 7 = Left speaker only

After 5 seconds control reverts back to volume control.

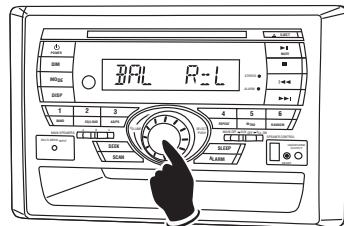

## Sound Controls (Continued)

### Equalizer (EQ):

Press the **EQ** button to choose between the pre-set equalizer settings: Flat, Classic, Rock, Popular and Jazz as indicated in the display area.

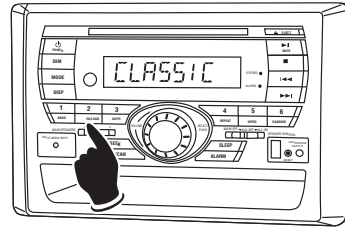

### Loud:

To boost high and low tones at low volume levels, press and hold the **EQ** button until "LOUD ON" appears in the display. To deselect, press and hold the **EQ** button again until "LOUD OFF" appears in the display.

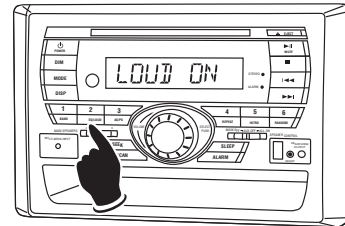

Hold

### Mute:

Press the **MUTE** button to mute the volume level. If a disc is playing the **MUTE** button will pause the disc. Press the **MUTE** button again to restore the volume or resume playing the disc.

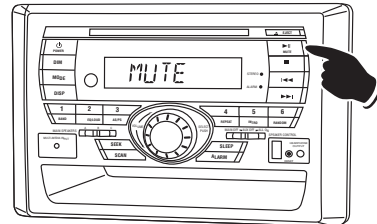

## Speaker Selection Switches

### Main Speakers:

Slide the **Main Speaker Switch** to play audio through speaker set A, speaker set B or speaker set C.

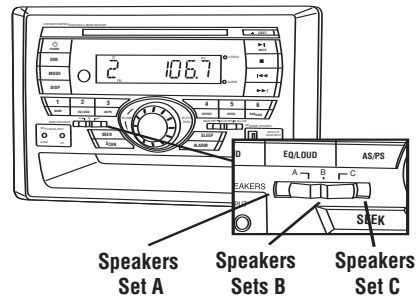



## Speaker Selection Switches (Continued)

### Auxiliary Speakers:

Slide the **Speaker Control Switch** to turn:

- Main speaker off and auxiliary speakers on (MAIN OFF),
- Main speakers on and auxiliary speakers off (AUX OFF) or
- Main speakers on and auxiliary speakers on (ALL ON).

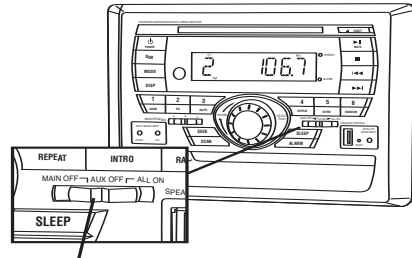

Speaker Control

## Setting the Clock

1. Press the **DISP** button until the clock appears in the display.
2. Press and hold the **DISP** button until the hour indicator start flashing.
3. Rotate the **VOLUME** knob until the correct Hour appears in the display.  
**Note:** When setting the clock make sure to select the correct AM or PM indicator.

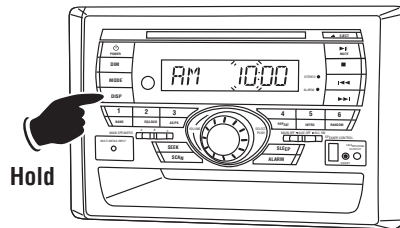

Hold

4. Press the **VOLUME** knob and the Minute indicators will start flashing.
5. Rotate the **VOLUME** knob until the correct Minutes appears in the display.
6. Press the **DISP** button and the colon between the hours and the minutes will start flashing indicating the clock is set.

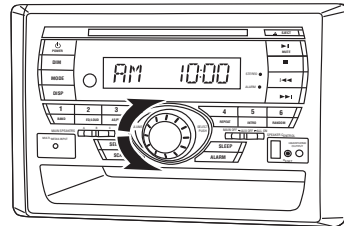

## Sleep Timer Operation

### Setting the Sleep Timer:

1. Press the **SLEEP** button until the "SLEEP" appears in the display.
2. Keep pressing the **SLEEP** button again until the desired sleep time appears in the display (0, 10, 20, 30, 40, 50, 60, 70, 80 minutes).
3. Wait 5 seconds and the display will return to normal operation.
4. After the designated sleep timer has expired the unit will turn off automatically.

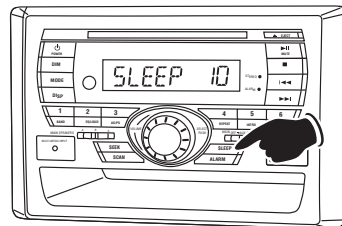

### Cancelling the Sleep Timer:

1. Press the **SLEEP** button until "SLEEP 0" is displayed.
2. Wait 5 seconds and the display will return to normal operation.

## Alarm Operation

### Setting the Alarm Timer:

1. Press and release the **ALARM** button and the hour indicators will start flashing.
2. Rotate the **VOLUME** knob until the correct Hour appears in the display.  
**Note:** When setting the alarm clock make sure to select the correct AM or PM indicator.
3. Press the **VOLUME** knob and the Minute indicators will start flashing.
4. Rotate the **VOLUME** knob until the correct Minutes appears in the display.
5. Press the **ALARM** button and the display will return to normal operation. The alarm indication LED will now be lit.
6. Press the **POWER** button to turn the unit off. The unit will automatically turn on when the set alarm time is reached.

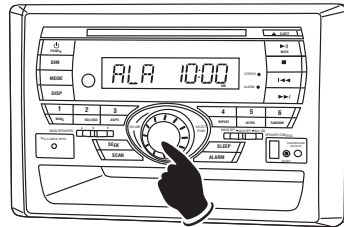
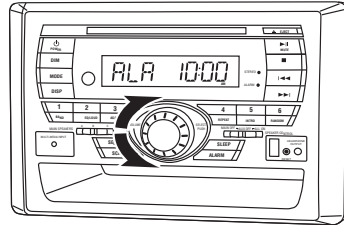
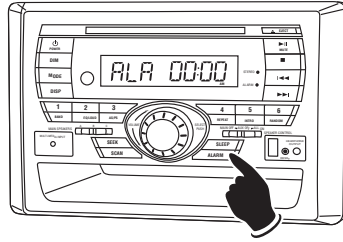

### Cancelling the Alarm Timer:

1. Press and release the **ALARM** button and the hour indicators start flashing.
2. Rotate the **VOLUME** knob until Hours appears as 00:00 in the display.
3. Press the **VOLUME** knob and the Minute indicators will start flashing.
4. Rotate the **VOLUME** knob until Minutes appears as 00:00 in the display.
5. Press the **ALARM** button and the display will return to normal operation. The alarm indication LED will now be off.

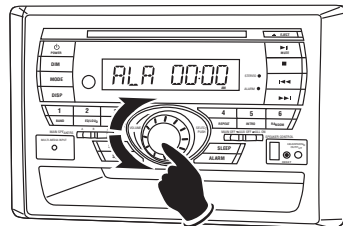

## Radio Operations

### Power On/Off:

Press the **POWER** button to turn the unit On.

### Selecting the Play Source:

Press the **MODE** button until "RADIO" appears in the display. After a brief moment either AM or FM will appear in the display.

### Selecting the AM or FM:

Press the **BAND** button repeatedly and select from 1 FM, 2 FM, 3 FM, 1 AM or 2 AM.

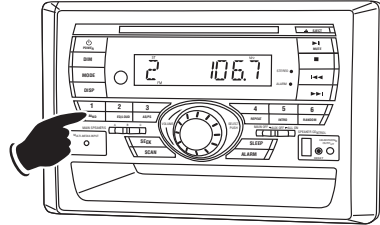

### Manually Tuning in a Radio Station:

Press the **I◀◀** button to tune in a lower radio station. Press the **▶▶I** button to tune in a higher radio station.

**Note:** The unit will automatically switch from FM Mono to FM Stereo when the signal strength increases to a stereo level. If the stereo signal should become weak, the unit will switch back to Mono. FM stereo reception is indicated when the STEREO LED is lit.

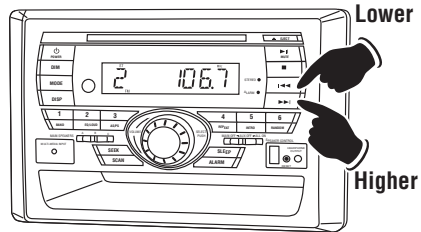

### Tuning in a Radio Station Using Seek:

Press the **SEEK** button and the tuner will scan up to the next strong station and stop seeking, then start playing.

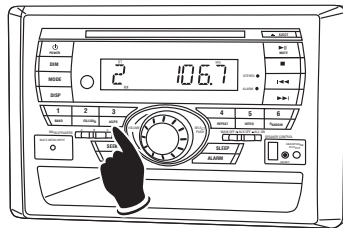

### Tuning in a Radio Station Using Scan:

Press the **SCAN** button and the tuner will scan up to the next strong station and pause for 6 seconds, then scan for the next strong station. To cancel this function press the **SCAN** button again.

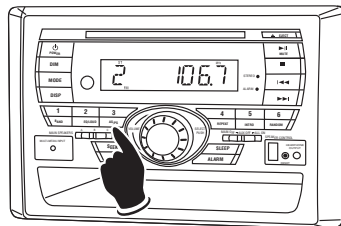

## Radio Operation (Continued)

### Memorizing Radio Stations:

1. Press the **BAND** button to select either the 1 FM, 2 FM, 3 FM, 1 AM or 2 AM radio band.
2. Tune-in the desired radio station.
3. To memorize the station press and hold any one of the six radio station recall buttons until the preset number appears.

### Radio Station Recall Buttons

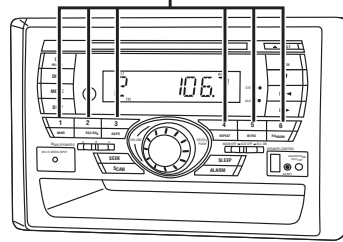

### Automatically Store Radio Stations:

1. Press the **BAND** button to select either the FM or AM radio band.
2. Press and hold the **AS/PS** button then release. The tuner will search for the strongest stations and store them into memory. The new stations will replace stations that were previously stored in the current band.

**Note:** When the FM band is selected the 18 strongest stations will be stored into 1 FM, 2 FM and 3 FM. When AM band is selected the 12 strongest stations will be stored into 1 AM and 2 AM.

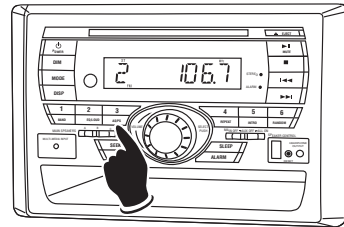

**Hold**

### Scanning Stored Radio Stations:

1. Press the **BAND** button to select either the FM or AM radio band.
2. Press the **AS/PS** button then release. The tuner scans for preset stations stored in the current band and pauses for 5 seconds at each station. When a desired station is reached, press the **AS/PS** button again to stop scanning.

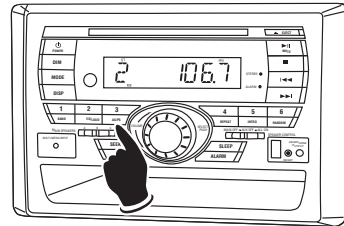

## Disc Warnings

### Handling and Cleaning:

- Dirt, dust, scratches and warping disc will cause non operation.
- Do not place stickers on disc or scratch disc.
- Do not warp discs.
- A disc should always be kept in its case when not in use to prevent damage.
- Do not place discs in the following places:
  1. Direct sunlight.
  2. Dirty, dusty and damp areas.
  3. Near car heaters.
  4. Car seats or dashboard.

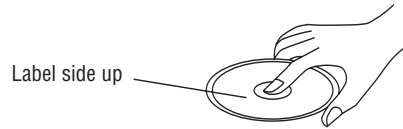

Do not touch the underside of the disc



Do not bend



Wipe the disc from the center toward the outside edge

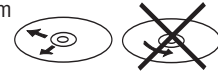

### Disc Cleaning:

Use a dry soft cloth to wipe disc the surface. If the disc is quite dirty, use a soft cloth slightly moist with isopropyl (rubbing) alcohol. Never use solvents such as benzene, thinner or conventional record cleaners as they may mar the surface of the disc.

**Note:** A disc may become somewhat scratched (although not enough to make it unusable) depending on handling and conditions in the usage environment.

### Preparing New Discs with Rough Spots:

A new disc may have rough edges on its inside and outside edges. If a disc with rough edges is used, the proper setting will not be performed and the player will not play the disc. Therefore, remove the rough edges in advance by using a ball point pen or pencil as shown. To do this, press the side of the pen or pencil against the inside and outside edges of the disc.

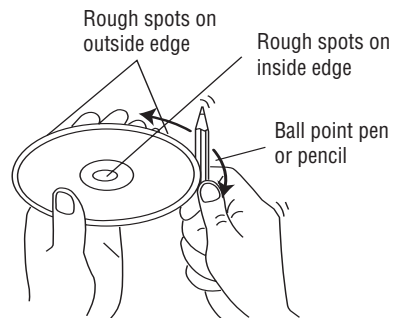

## Music Disc Operation

### General Operations:

1. Press the **POWER** button to turn the unit On.
2. Gently insert the disc into the slot with the label side up. The unit will automatically load the disc.

**Note:** If a disc does not auto-load **DO NOT FORCE** into the slot, as you may already have a disc loaded.

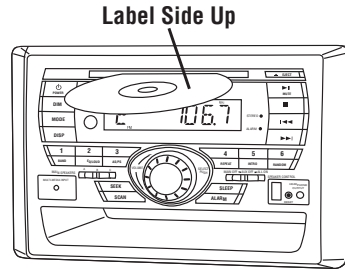

### Music Track Selection:

Press the **◀◀** button to select a lower track.  
Press the **▶▶** button to select a higher track.  
The track number will appear in the display.

Tracks can also be selected by using the remote control. Press the track selection number button that corresponds to the track you want to play then press the **ENTER** button.

For example: If you want to play track 8, press button **8** then the **ENTER** button. Track 8 will start playing and "8" will appear in the display.

If you want to play track 12, press **10+**, then press button **1**, followed immediately by button **2**, and finally press the **ENTER** button. Track 12 will start playing and "12" will appear in the display.

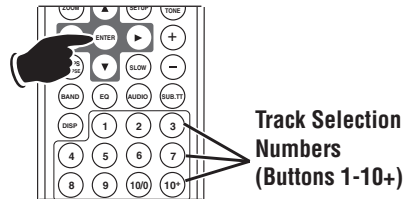
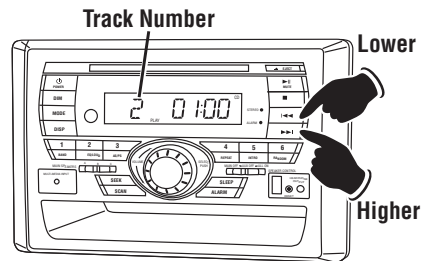

### Pausing the Disc:

Press the **▶||** button to pause the disc, press it again to resume play.

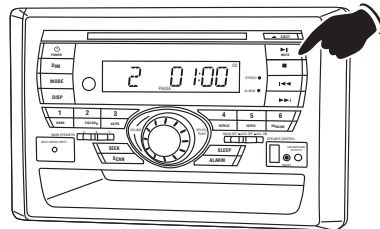

### Stopping the Disc:

Press the **■** button to stop the disc. To resume play, press the **▶||** button.

Pressing the **■** button 2 times, then pressing the **▶||** button will play the disc from the beginning.

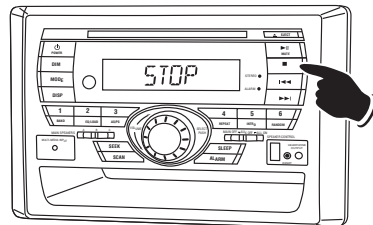

## Music Disc Operation (Continued)

### Ejecting the Disc:

Press the **EJECT** button to eject a disc.

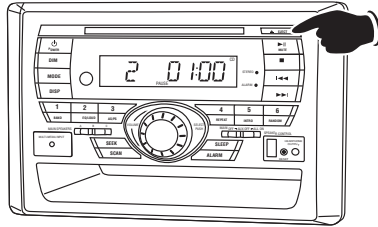

### Repeating a Music Track or Entire Disc:

Select the desired track to repeat, then press the **REPEAT** button once and "REPEAT" appears in the display. This track will play repeatedly. Press the **REPEAT** button one more time and "REPEAT" will remain in the display. The entire CD will now be repeated. To cancel this feature press the **REPEAT** button again and "REPEAT" disappears from the display.

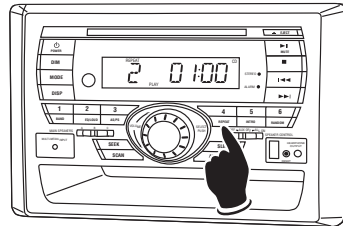

### Preview Music Tracks:

Press the **INTRO** button until "INTRO" appears in the display. Each track on the disc will play for 6 seconds. To cancel this feature press the **INTRO** button until "INTRO" disappears from the display.

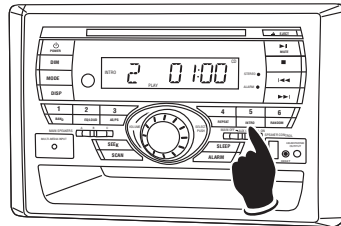

### Random Music Track Play Order:

Press the **RANDOM** button until "RANDOM" appears in the display. The tracks on the disc will play in a random order. To cancel this feature press the **RANDOM** button again.

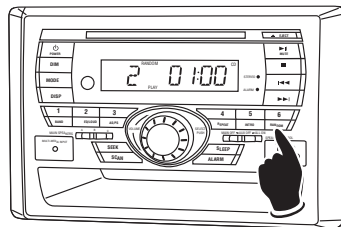

### Elapse Times:

Continue to press the **AS/PS** button during music disc play to display the following disc information in this order:

Single Remain, Single Elapse, Total Remain and Total Elapse.

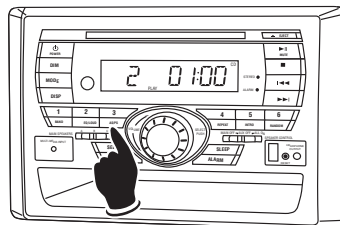

## MP3 Disc Operation

### General Operations:

1. Press the **POWER** button to turn the unit on.
2. Gently insert the disc into the slot with the label side up. The unit will automatically load the disc.

**Note:** If a disc does not auto-load **DO NOT FORCE** into the slot, as you may already have a disc loaded.

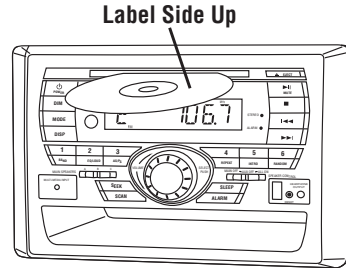

### Disc File Selection:

Press the **◀◀** button to select a lower file.  
Press the **▶▶** button to select a higher file. The file number will appear in the display.

File selection can also be selected by using the remote control. Press the file selection number button that corresponds to the file you want to play.

For example: If you want to play file 8, press button **8**.

If you want to play file 28, press button **2**, followed immediately by button **8**. File 28 will start playing and "28" will appear in the display.

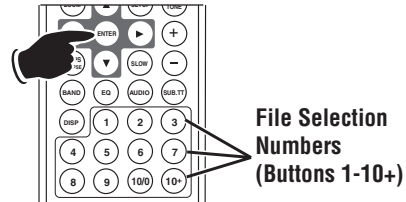
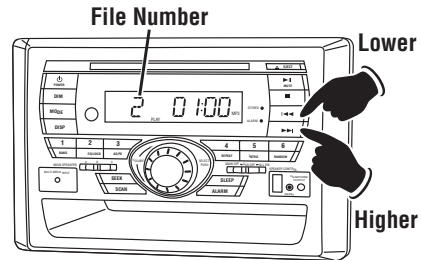

### Pausing the Disc:

Press the **⏸** button to pause the disc, press it again to resume play.

### Ejecting the Disc:

Press the **EJECT** button to eject the disc.

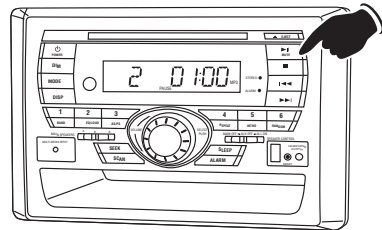

### Stopping the Disc:

Press the **■** button to stop the disc. To resume play, press the **⏸** button.

Pressing the **■** button 2 times. Then press the **⏸** button and the disc will start playing from the beginning.

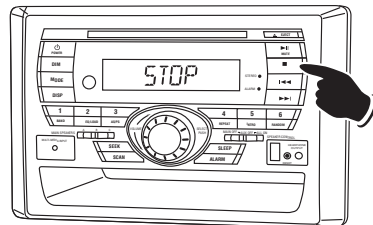



## Movie Disc Operation

### General Operations:

1. Press the **POWER** button to turn the unit On.
2. Gently insert the disc into the slot with the label side up. The unit will automatically load the disc.

**Note:** If a disc does not auto-load **DO NOT FORCE** into the slot, as you may already have a disc loaded.

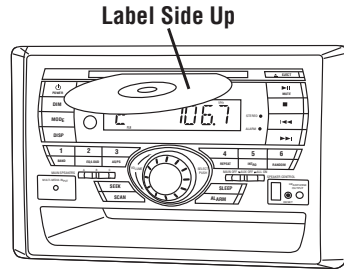

### Pausing a Movie:

Press the **▶||** button to pause the disc, press it again to resume play.

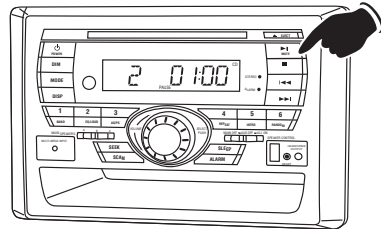

### Stopping a Movie:

Press the **■** button to stop the disc. To resume play, press the **▶||** button.

Pressing the **■** button 2 times. Then pressing the **▶||** button and the disc will start playing from the beginning.

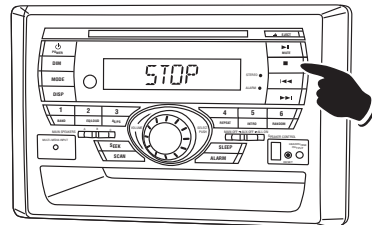

### Movie Chapter Selection:

Press the **I◀◀** button to select a lower chapter.  
Press the **▶▶I** button to select a higher chapter.  
The chapter number will appear in the display.

Chapter selection can also be selected by using the remote control. Press the chapter selection number button that corresponds to the chapter you want to play then press the **ENTER** button.

For example: If you want to play chapter 8, press button **8**, then the **ENTER** button.

If you want to play chapter 28, press the **10+** button twice followed immediately by button **8**. Chapter 28 will start playing and "28" will appear in the display.

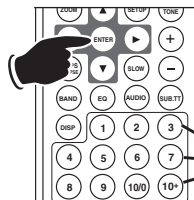
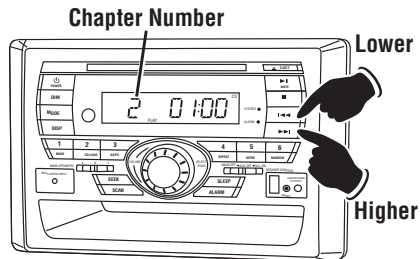

**Chapter Selection Numbers (Buttons 1-10+)**

## Movie Disc Operation (Continued)

### Fast Forward / Fast Reverse Disc Play:

Press the **▶▶** (fast forward) or **◀◀** (fast reverse) button during play. Each time the button is pressed, the speed of fast forward/fast reverse changes in the following order:

2X, 4X, 8X, 16X, 32X

To resume normal play, press the **▶** (Play) button 2 times.

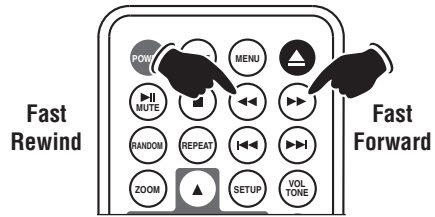

### Slow Motion:

Continue to press the **SLOW** button to play the movie disc is slow motion in the following order:

Forward **▶** 1/2, 1/4, 1/8, 1/16 then Reverse

**◀** 1/2, 1/4, 1/8, 1/16

To resume normal play, press the **▶** (Play) button 2 times.

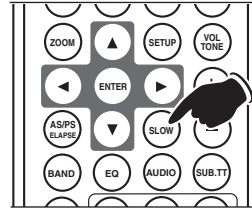

### Repeat:

Continue to press the **REPEAT** button to select a repeat mode in the following order:

Repeat Chapter, Repeat Title, Repeat All, Normal Play.

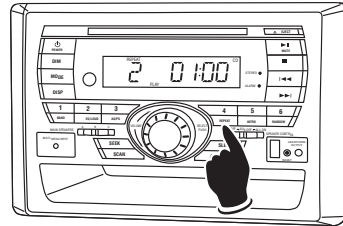

### Elapse Times:

Continue to press the **AS.PS/ELAPSE** button during movie disc play to display the following disc information in this order:

Title Elapse, Title Remain, Chapter Elapse, Chapter Remain and Display Off.

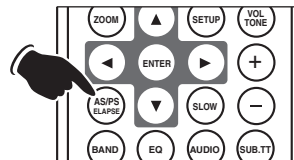

### Menu Function:

Press the **MENU** button during disc play and the main menu will be displayed. Scroll through the menu with the **NAVIGATION BUTTONS**. Select a feature by pressing the **ENTER** button.

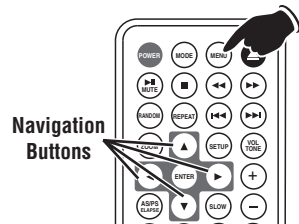

### Audio Language Menu:

Press the **AUDIO** button during playback to review the current setting. Most movies have their own audio setup. Go to the onscreen menu to select appropriate audio/language setup.

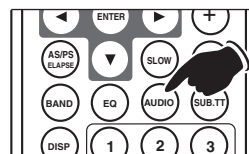

## Movie Disc Operation (Continued)

### Subtitle Language Menu:

Press the **SUB.TT** button during playback. Each time the button is pressed, the subtitle language changes in sequential order.

- Some discs may only contain one subtitle language.
- Depending on the disc, the number of subtitle languages may be different.

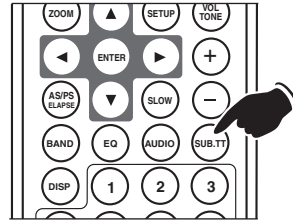

### Zooming the Image:

To enlarge the onscreen image during disc play, press the **ZOOM** button. Each time the button is pressed, the magnification increment changes in the following order:

2X, 3X, 4X, 1/2, 1/3, 1/4.

Use the navigation buttons to move the image on the screen.

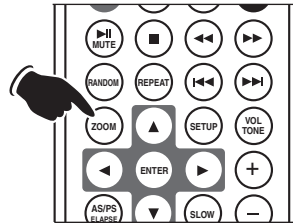

## Setup Menu

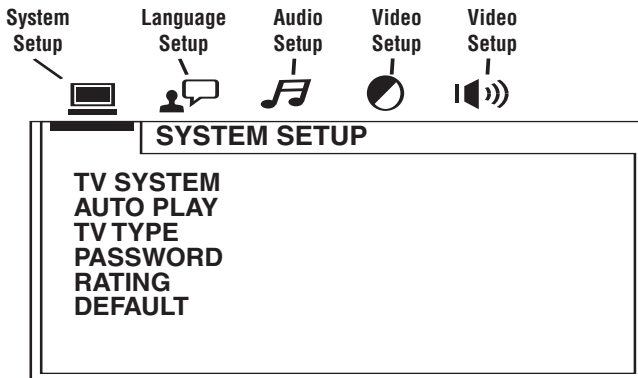

With a disc inserted press the **SETUP** button on the remote control to display the Setup Menu:

### System Setup:

Use the navigation buttons to scroll between the menu items. Make a selection by pressing the **ENTER** button.

- TV System: NTSC, PAL or AUTO
- Auto Play: On, Off
- TV Type: 4:3 PS, 4:3 LB or 16:9.
- Password: \_ \_ \_ \_ \_
- Rating: 1 Kid Safe, 2 G, 3 PG, 4 PG-13, 5 PG-R, 6 R, 7 NC-17 or 8 Adult
- Default: Restore

### Language Setup:

Use the navigation buttons to scroll between the menu items. Make a selection by pressing the **ENTER** button.

- OSD Language: English, Spanish
- Audio: Chinese, English, Japan, French, Spanish, Portuguese, Latin or German
- Subtitle: Chinese, English, Japan, French, Spanish, Portuguese, German or OFF
- Menu: Chinese, English, Japan, French, Spanish, Portuguese, German or Latin

## Setup Menu (Continued)

### Audio Setup:

Use the navigation buttons to scroll between the menu items. Make a selection by pressing the **ENTER** button.

- Audio: SPDIF/Off, SPDIF/Raw or SPDIF/PCM

### Video Setup:

Use the navigation buttons to scroll between the menu items. Make a selection by pressing the **ENTER** button.

- Brightness: 12, 10, 8, 6, 4, 2 or 0
- Contrast: 12, 10, 8, 6, 4, 2 or 0
- Hue: +6, +4, +2, 0, -2, -4, -6
- Saturation: 12, 10, 8, 6, 4, 2 or 0
- Sharpness: 8, 6, 4, 2, 0

### Digital Setup:

Use the navigation buttons to scroll between the menu items. Make a selection by pressing the **ENTER** button.

- Dynamic Range: Full, 6/8, 4/8, 2/8 or Off
- Dual Mono: Stereo, Mono L, Mono R or Mix Mono

## Audio/Video Input

### Selecting the Audio/Video Play Source:

To select a Audio/Video play source, press the **MODE** button until "AV IN F" appears in the display. Refer to the audio/video device's owners manual for proper operation.

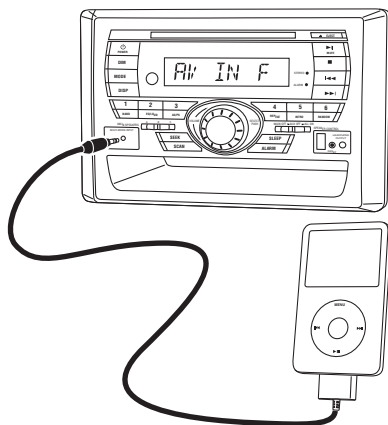

## Headphone Output

### Plugging in Headphone:

Insert a 3.5mm headphone jack into the Headphone Output socket. Use the Volume knob to adjust the audio level.

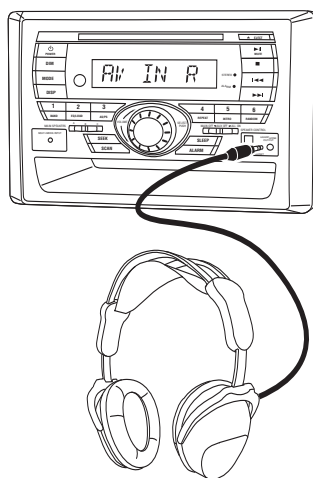

## IPOD Operation

### General Operations:

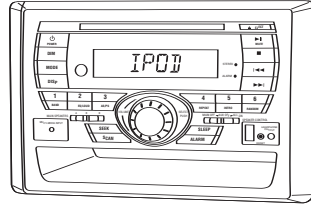

1. Press the  button to turn the unit On.
2. Connect an IPOD to the cable attached to the RV5060.
3. The unit will automatically switch to the IPOD mode and start playing.

**Note:** The IPOD controls will become inoperable, and the RV5060 now controls the IPOD.



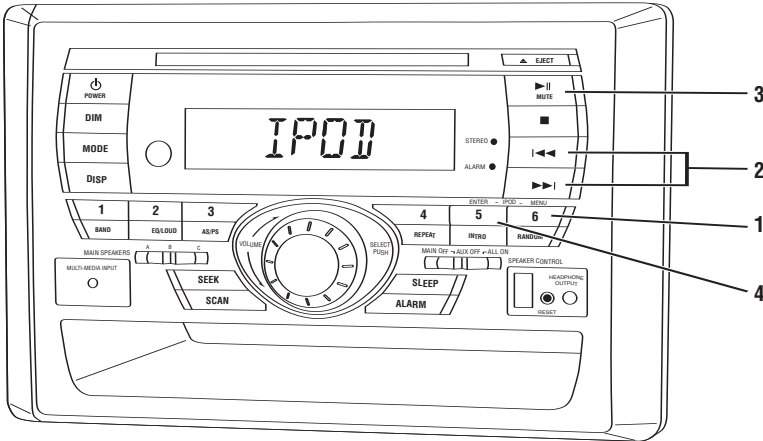

### IPOD Mode Button Location and Functions:



1. **Preset #6 Button:** Same operation as the MENU button on an IPOD.
2. **Track Up/Down Buttons:** Press these buttons to scroll through the menu items, which is the same operation as the IPOD's Click Wheel.
3. **Play/Pause Button (  ):** Same operation as the  button on an IPOD.
4. **Preset #5 Button:** Same operation as the Center Select/Enter button on an IPOD.

### Browse for a Song:

1. Press the **6** button and "PLAYLIST" will appear in the display.
2. Press the  or  button to select the "SONGS" menu.

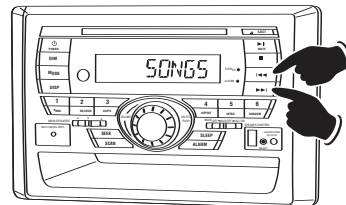
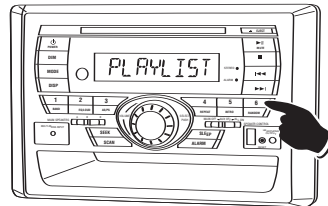

## IPOD Operation (Continued)

3. Press the **5** button to select the SONGS menu.

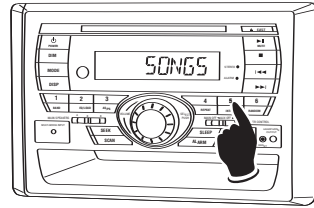

4. Press the **Track Up/Down** button to select the desired song from the menu. The selected song will automatically start playing.

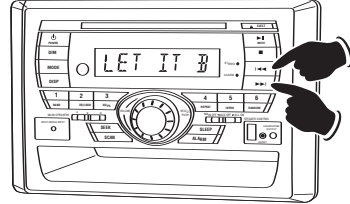

### Pausing a Track:

Press the **▶||** button to pause the track. Press it again to resume play.

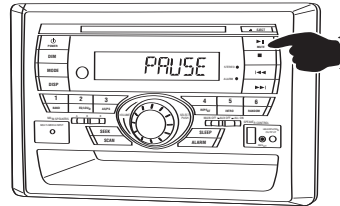

### Repeating a Track:

Select the desired track to repeat, then press the **REPEAT** button once and "IPOD RPT" will appear in the display. This track will play repeatedly. To cancel this function press the **REPEAT** button one more time, and "IPOD RPT" will disappear from the display.

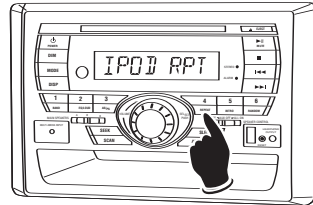

### Random Order Track Play:

Press the **SHUFFLE** button until "IPOD SHF" appears in the display. The tracks on the IPOD will now play in a random order. To cancel this feature press the **SHUFFLE** button again and "IPOD SHF" will disappear from the display.

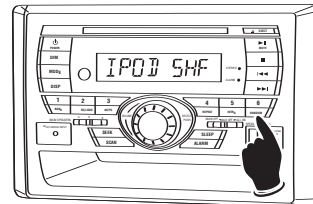

## IPOD Operation (Continued)

### Preview Tracks:

Press the **INTRO** button until "IPOD SCN" appears in the display. Each track on the IPOD will now play for 10 seconds. To cancel this feature press the **INTRO** button until "IPOD SCN" disappears from the display.

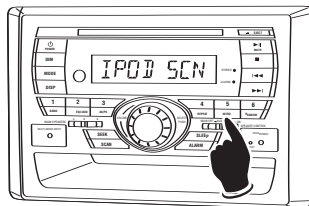

### Display Selection:

Press the **DISPLAY** button to display the following track information: Elapse Time, Title, Artist, Album and Track.

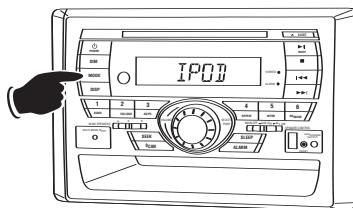

### Manually Selecting the IPOD Source:

If a different source is playing and you wish to listen to the IPOD, press the **MODE** button until "IPOD" appears in the display. The last song that was playing on the IPOD will resume.

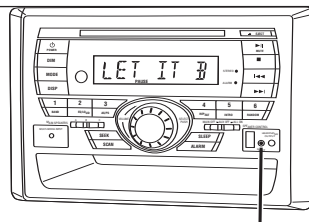

Reset Button



## USB Input

### Selecting USB Audio Play Source:

To select a USB play source, press the **MODE** button until "DISC" appears in the display. When the player is properly connected it will play automatically. Use the controls on the RV5060 to select the desired file to play.

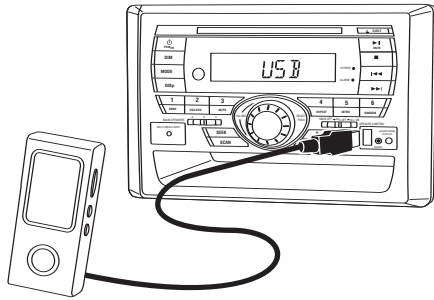

### Disc File Selection:

Press the **▶▶1** button to select a lower file.  
Press the **1◀◀** button to select a higher file. The file number will appear in the display.

File selection can also be selected by using the remote control. Press the file selection number button that corresponds to the file you want to play then press the **ENTER** button.

For example: If you want to play file 8, press button **8**, then the **ENTER** button.

If you want to play file 28, press **10+**, then press button **2**, followed immediately by button **8** and finally press the **ENTER** button. File 28 will start playing and "28" will appear in the display.

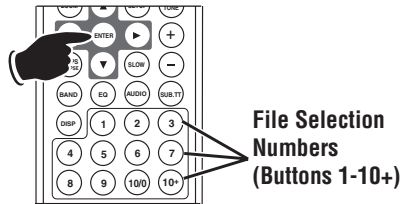
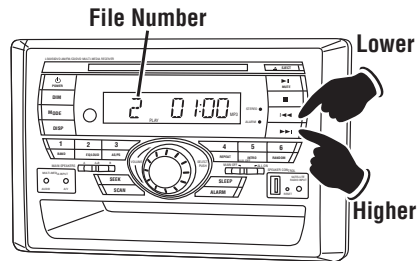

### Pausing a MP3 Player:

Press the **▶||** button to "Pause" the player, press it again to resume play.

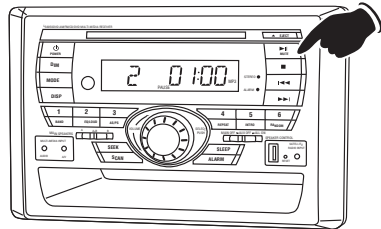

### Stopping a MP3 Player:

Press the **■** button to "Stop" the player. To resume play, press the **▶||** button.

Pressing the **■** button 2 times. Then press the **▶||** button and the disc will start playing from the beginning.

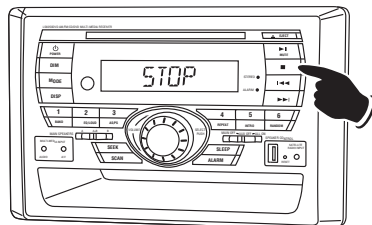

## Reset Button

The LCD display may fail to function normally due to the vehicle's battery condition, and could require resetting the radio microprocessor if:

- The vehicle has been "jump started" from a dead battery condition.
- The vehicle battery becomes very low and is quick-charged.
- The vehicle battery is removed and replaced.

Should any of these conditions occur, simply press and release the **RESET** button on the radio front panel using the tip of a ball point pen. This will reset the radio microprocessor to the original factory settings. After pressing the **RESET** button you should recheck to see if the radio functions normally.

## Installation

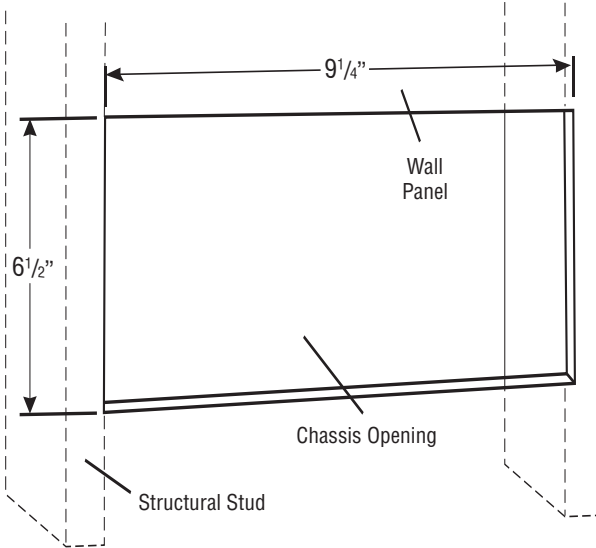

 **Caution:** Do not install radio without rear cover installed: No user-serviceable parts inside. Rear cover provides protection against potential fire hazard.

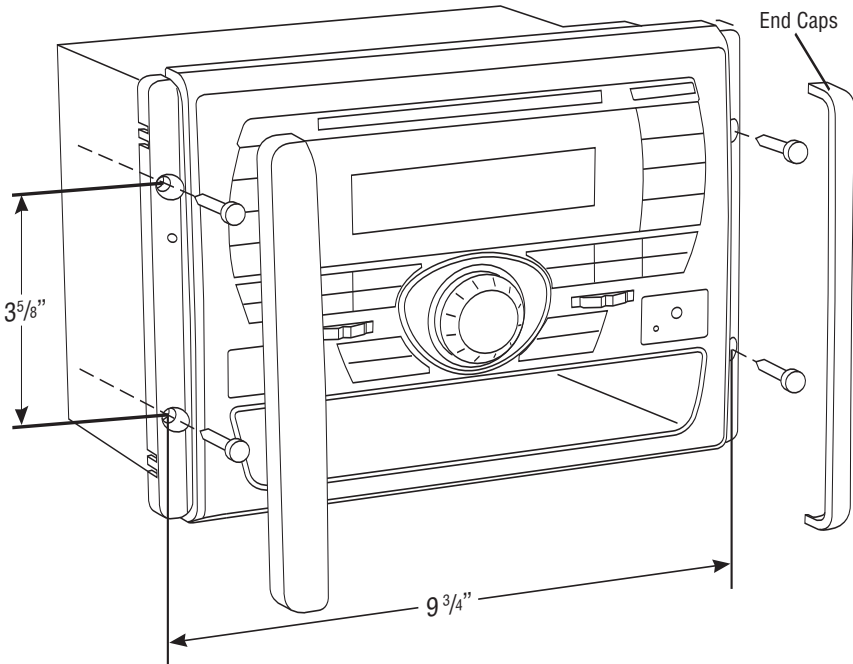

## Speaker Connections

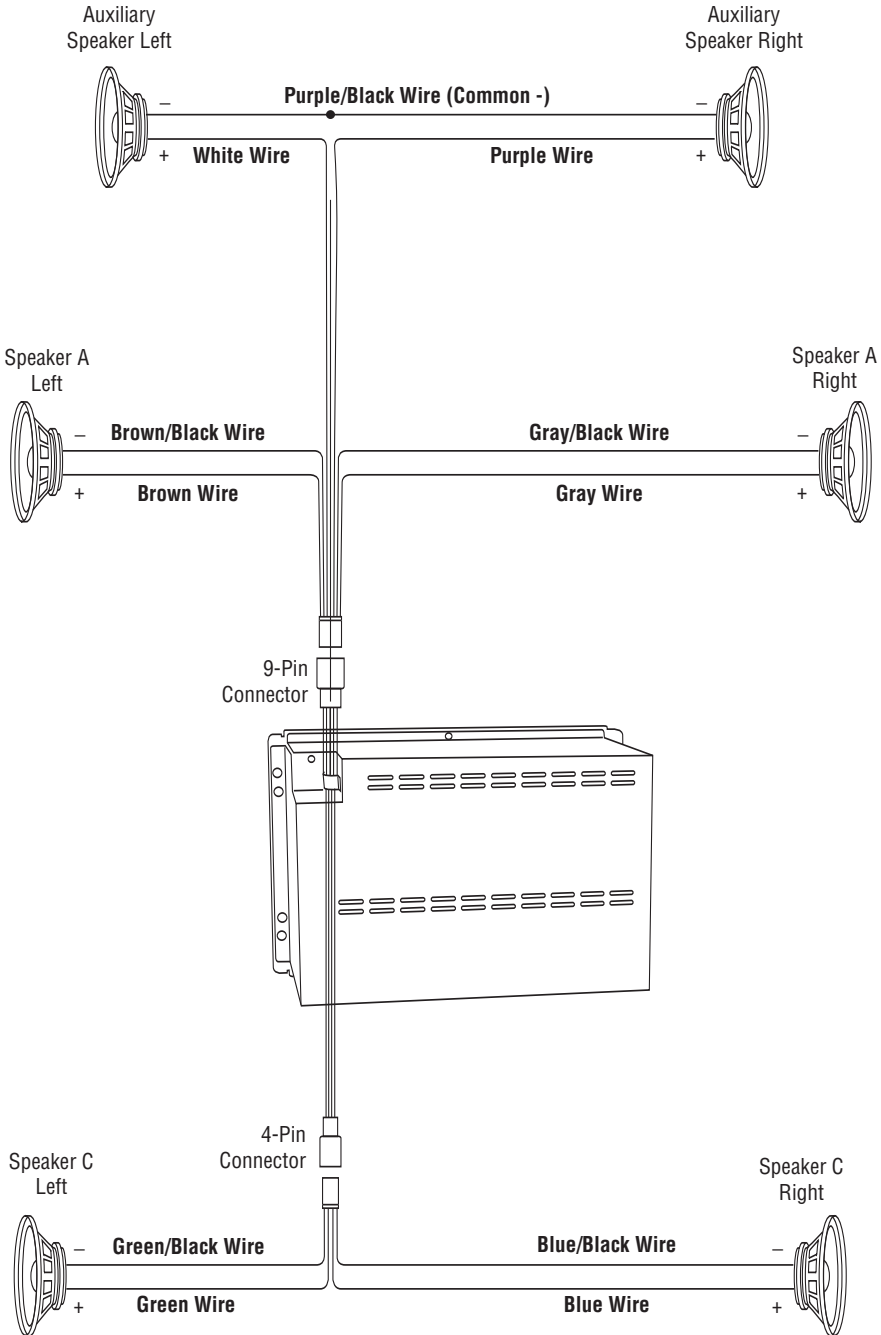

## Auxiliary Connections

This unit for use only with a 12 Volt DC power source with a negative ground.

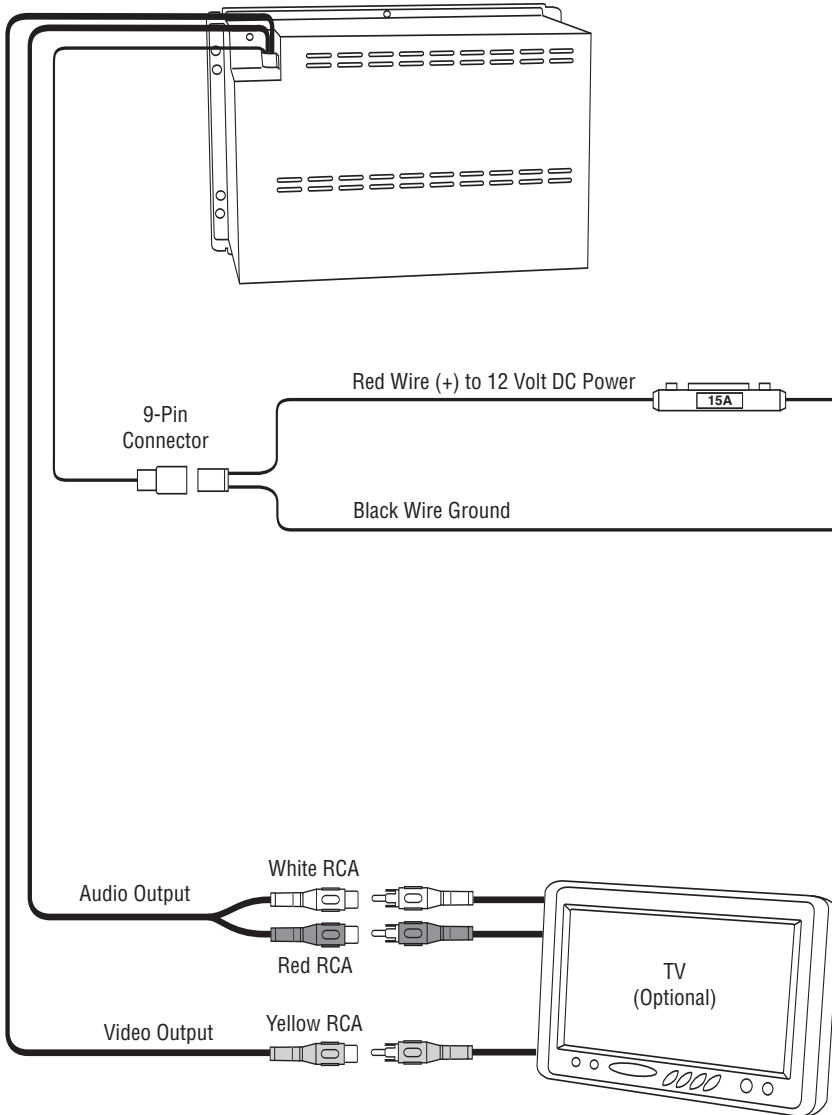

## Input Connections

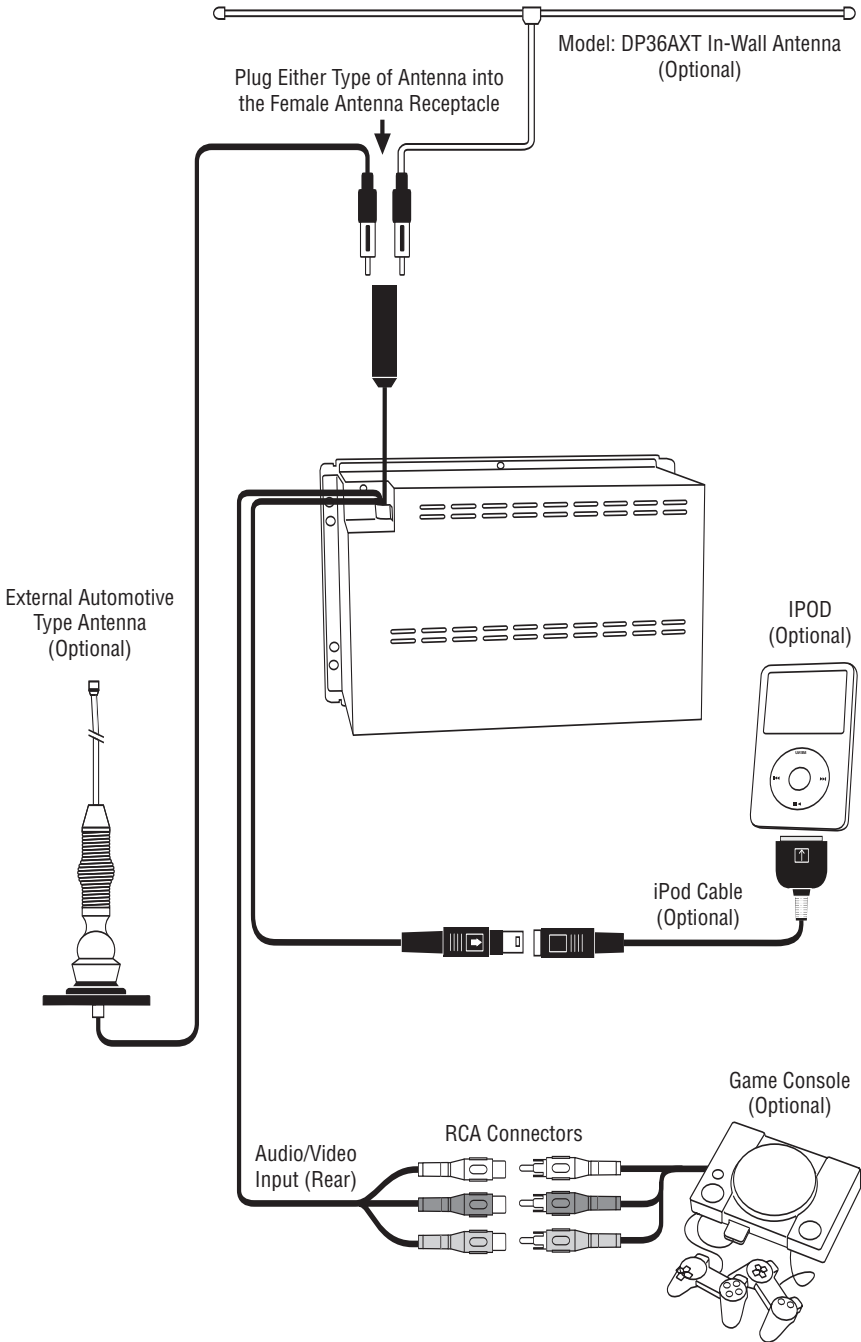

## Safety Instructions

- **Read Instructions:** All the safety and operating instructions should be read before the appliance is operated.
- **Retain Instructions:** The safety and operating instructions should be retained for future reference.
- **Heed Warnings:** All warnings on the appliance and in the operating instructions should be adhered to.
- **Follow Instructions:** All operating and use instructions should be followed.
- **Water and Moisture:** The appliance should not be used near water. For example, near a bathtub, wash-bowl, kitchen sink, laundry tub, in a wet basement, or near a swimming pool, etc.
- **Wall or Cabinet Mounting:** The appliance should be mounted to a wall or cabinet only recommended by the manufacturer.
- **Heat:** The appliance should be situated away from heat sources such as radiators, heat registers, stoves, or other appliances (including amplifiers) that produce heat.
- **Power Supply:** The appliance should be connected to a power supply only of the type described in the operating instructions or as marked on the appliance.
- **Power Lines:** An outdoor antenna should be located away from power lines.
- **Object and Liquid Entry:** Care should be taken so that objects do not fall, and liquids are not spilled into the enclosure through openings.

### Outdoor Antenna Grounding:

If an outside antenna is connected to the receiver, be sure the antenna system is grounded, so as to provide some protection against voltage surges and built up static charges. Section 810 of the National Electrical Code, ANSI/NFPA No. 70-1983, provides information with respect to proper grounding of the mast and supporting structure, grounding of the lead-in wire to an antenna discharge unit, size of grounding conductors, location of antenna-discharge unit, connection to grounding electrodes, and requirements for the grounding electrode. See illustration below.

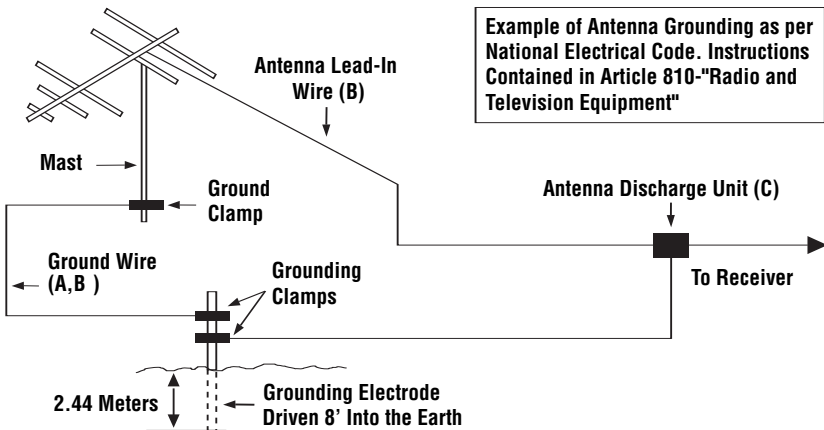

Example of Antenna Grounding as per National Electrical Code. Instructions Contained in Article 810-"Radio and Television Equipment"

- Use No. 10 AWG (5.3mm<sup>2</sup>) copper, No. 8 AWG (8.4mm<sup>2</sup>) aluminum, No. 17 AWG (1.0mm<sup>2</sup>) copper clad steel or bronze wire, or larger as ground wire.
- Secure antenna lead-in and ground wires to house with stand-off insulators spaced from 4 feet (1.22m) to 6 feet (1.83m) apart.
- Mount antenna discharge unit as close as possible to where lead-in enters house.

## Warranty

### ONE (1) YEAR LIMITED WARRANTY

Magnadyne Corporation or its authorized agents will within one year from the date of sale to you, repair, replace or refund the retail sales price of said product or any part thereof, at the option of the Magnadyne Corporation or its authorized agents, if said product or part is found defective in materials or workmanship, when properly connected and operating on the correct power requirements designated for the specific product. This warranty and Magnadyne Corporation or its authorized agent's obligations hereunder do not apply where the product was; damaged while in the possession of the consumer, subjected to unreasonable or unintended use, not reasonably maintained, utilized in commercial or industrial operations, or serviced by anyone other than Magnadyne Corporation or its authorized agents, or where the warning seal on the product is broken or the power and/or plugs are detached from the unit. Magnadyne Corporation or any of its authorized agents will not assume any labor costs for the removal and reinstallation of any product found to be defective, or the cost of transportation to Magnadyne Corporation or its authorized agents. Such cost are the sole responsibility of the purchaser.

This warranty does not cover the cabinet appearance items or accessories used in connection with this product, or any damage to recording or recording tape, or any damage to the products resulting from improper installation, alteration, accident, misuse, abuse or acts of nature.

MAGNADYNE CORPORATION OR ITS AUTHORIZED AGENTS SHALL NOT BE LIABLE TO ANYONE FOR CONSEQUENTIAL OR INCIDENTAL DAMAGES OR CLAIMS EXCEPT THOSE ACCORDED BY LAW. NO EXPRESSED WARRANTY OR IMPLIED WARRANTY IS GIVEN EXCEPT THOSE SET FORTH HEREIN. NO IMPLIED WARRANTY SHALL EXTEND BEYOND ONE YEAR FROM THE DATE OF SALE.

This warranty extends only to the original purchaser of the product and is not transferable. Some states do not allow limitations on how long an implied warranty lasts, and some states do not allow the exclusion or limitation of incidental or consequential damages, so the above limitations or exclusion may not apply to you. This warranty gives you specific legal rights, and you may have other rights that vary from state to state.

**“NOTE: The manufacturer is not responsible for any radio or TV interference caused by unauthorized modifications to this equipment. Such modifications could void the User's authority to operate the equipment.”**

Defective merchandise should be returned to the original point of purchase or secondly, to Magnadyne Corporation, 1111 W. Victoria Street, Compton CA 90220.

Return Authorization must be obtained before sending, or merchandise may be refused.



## Free Manuals Download Website

<http://myh66.com>

<http://usermanuals.us>

<http://www.somanuals.com>

<http://www.4manuals.cc>

<http://www.manual-lib.com>

<http://www.404manual.com>

<http://www.luxmanual.com>

<http://aubethermostatmanual.com>

Golf course search by state

<http://golfingnear.com>

Email search by domain

<http://emailbydomain.com>

Auto manuals search

<http://auto.somanuals.com>

TV manuals search

<http://tv.somanuals.com>