

D-67 D-67L D-67F DX-12

STANDARD DIGITAL RECEIVERS

Installation Instructions

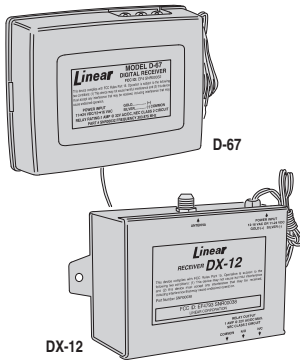

Linear
Building On Innovation.

USA & Canada (800) 421-1587 & (800) 392-0123
(760) 438-7000 - Toll Free FAX (800) 468-1340
www.linearcorp.com

3. SETTING THE CODE SWITCH

CHOOSE A CUSTOM SECURITY CODE

DO NOT USE THE FACTORY SET CODE

USE A POINTED OBJECT TO SET ON/OFF POSITIONS FOR KEYS 1-8 OF THE CODE SWITCH

NOTE: AVOID SETTING SWITCHES ALL ON, ALL OFF, OR IN AN ALTERNATING ON/OFF OR OFF/ON PATTERN

MATCH THE CODE IN ALL TRANSMITTERS USED WITH THE RECEIVER

FOR MULTI-CHANNEL TRANSMITTERS, REFER TO THE INSTRUCTIONS SUPPLIED WITH THE TRANSMITTER FOR SPECIAL CODING REQUIREMENTS

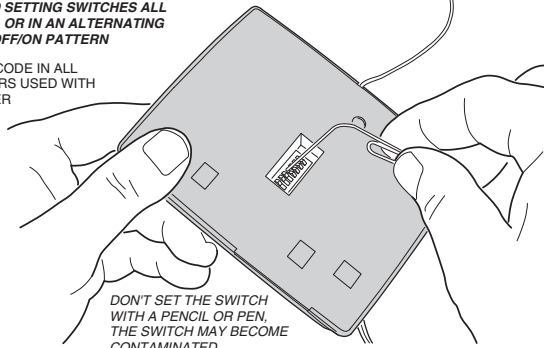

6. MOUNT RECEIVER

FOR D-67 RECEIVERS

FOR DX-12 RECEIVERS

ATTACH THE SUPPLIED MOUNTING BRACKET TO THE MOUNTING SURFACE

NOTE: FOR BEST RADIO RANGE, MOUNT THE RECEIVER AS HIGH AS POSSIBLE, AWAY FROM OTHER RECEIVERS AND POSSIBLE INTERFERENCE SOURCES

IMPORTANT: DO NOT MOUNT D-67 RECEIVERS INSIDE A METAL ENCLOSURE

CLIP RECEIVER ONTO MOUNTING BRACKET

STRAIGHTEN OUT ANTENNA WIRE

USE APPROPRIATE FASTENERS TO SECURE THE RECEIVER TO THE MOUNTING SURFACE

NOTE: DX-12 RECEIVERS MAY BE MOUNTED INSIDE A METAL ENCLOSURE AS LONG AS THE REMOTE ANTENNA IS LOCATED OUTSIDE OF THE ENCLOSURE

1. PRODUCT DESCRIPTION

Linear's single-channel standard digital receivers are used in wireless security systems and for various remote control applications. The receiver is typically connected to inputs of a hardwired alarm control panel, providing wireless remote capability.

Five models of the single-channel receiver are available.

Model D-67: Standard receiver, the output triggers for a minimum of four seconds when activated and will stay triggered as long as the transmitter is activated.

Model D-67L: Latching receiver, the output latches when activated until reset manually.

Model D-67F: Toggling receiver, the output alternately latches and unlatches when activated.

Model DX-12: Shielded receiver in a metal case with an external antenna input for connection to a Model EXA-1000 or EXA-2000 remote antenna, output triggers as long as the transmitter is activated.

To set a security code, standard digital receivers contain an eight-position coding switch. The switch can be set to one of 256 possible unique codes. Standard digital transmitters also contain a coding switch. Each single-channel transmitter used with the receiver must be set to the exact same security code. The receiver will only activate from transmitters set with a matching code. Multi-channel standard digital transmitters require setting some of the receiver code switches to pre-defined settings to select the activation channel. Refer to the instructions included with multi-channel transmitters for coding requirements.

For power, the D-67 & DX-12 receivers require 11-24 VDC or 12-16 VAC. The D-67L & D-67F receivers require 11-14 VDC or 12 VAC. Current consumption for all models is 15 mA during standby and 40 mA when the relay is energized.

Each receiver's relay output provides normally open and normally closed (Form "C"), with dry contacts (isolated from the power supply) rated at 1 Amp @ 32V AC/DC maximum, NEC Class 2 circuit.

The operating temperature range of these receivers is -4° to +140° F (-20° to +60° C).

4. TYPICAL ALARM CONTROL PANEL CONNECTIONS

RELAY OUTPUT

CONNECT THE RECEIVER RELAY OUTPUT TERMINALS TO THE DEVICE TO BE TRIGGERED

USE EITHER THE NORMALLY OPEN OR THE NORMALLY CLOSED TERMINAL AND THE COMMON TERMINAL

IF REQUIRED, CONNECT AN END-OF-LINE RESISTOR AT THE RECEIVER AS SHOWN

RELAY RATING:
1 AMP @ 32V AC/DC MAXIMUM

RECEIVER POWER

CONNECT THE RECEIVER POWER INPUT WIRES TO THE POWER SOURCE

CONNECT THE GOLD WIRE TO POSITIVE AND THE SILVER WIRE TO NEGATIVE (IGNORE POLARITY IF CONNECTING TO AN AC POWER SOURCE)

POWER REQUIREMENTS:

D-67 & DX-12: 11-24 VDC OR 12-16 VAC
D-67L & D-67F: 11-14 VDC OR 12 VAC
ALL D-67s & DX-12: 15 mA STANDBY, 40 mA RELAY ON

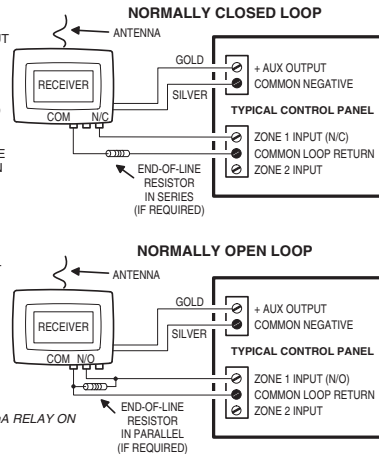

2. COMPONENT LOCATIONS

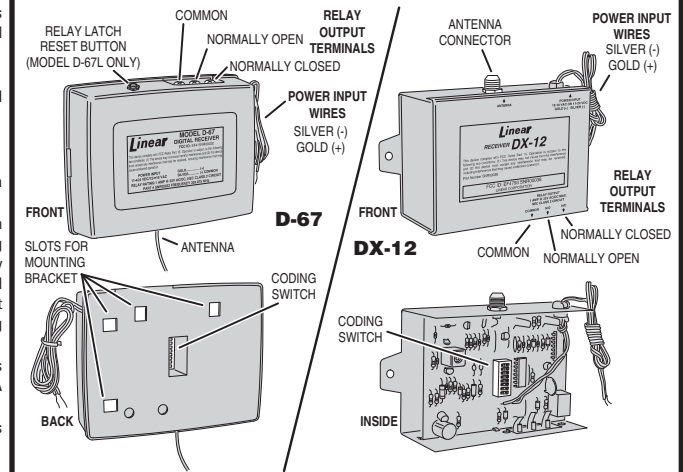

7. TEST SYSTEM

1. APPLY POWER TO THE RECEIVER. BE SURE THE ALARM CONTROL PANEL IS DISARMED OR IN A TEST MODE.

2. TRIGGER EACH TRANSMITTER CODED TO THE RECEIVER. THE RECEIVER RELAY SHOULD CLICK. VERIFY THAT THE PROPER ALARM CONTROL PANEL LOOP IS VIOLATED WHEN THE RECEIVER ACTIVATES.

IF THE RECEIVER FAILS TO ACTIVATE, CHECK THE CODE SWITCH SETTINGS AND VERIFY THAT RECEIVER HAS POWER.

3. WITH PORTABLE TRANSMITTERS, OPERATE THEM FROM VARIOUS LOCATIONS TO DETERMINE THE USABLE RADIO RANGE OF THE SYSTEM. THIS WILL HELP TO LOCATE POSSIBLE TROUBLE AREAS WHERE METAL OR OTHER MATERIALS MAY SHIELD THE RECEIVER FROM THE TRANSMITTER.

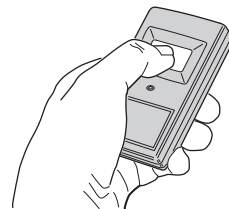

IMPORTANT: ELECTRONIC PRODUCTS ARE NO BETTER THAN THE INSPECTION AND MAINTENANCE THEY RECEIVE OVER TIME. THEREFORE, INSTALLERS SHOULD INSTRUCT THEIR CUSTOMERS TO TEST THIS EQUIPMENT REGULARLY, AT LEAST ONCE A WEEK.

5. ANTENNA CONNECTION (FOR MODEL DX-12 ONLY)

SCREW THE ANTENNA'S CABLE INTO THE RECEIVER'S ANTENNA CONNECTOR

NOTE: THE ANTENNA CABLE MAY BE EXTENDED UP TO 20 FEET, USE TYPE RG-59 CO-AX AND TYPE "F" CONNECTORS

NOTE: SIGNAL LOSS FROM EXTENDING THE ANTENNA CABLE MAY REDUCE THE RADIO RANGE

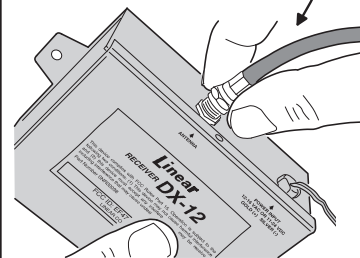

ANTENNAS AVAILABLE FOR THE DX-12:

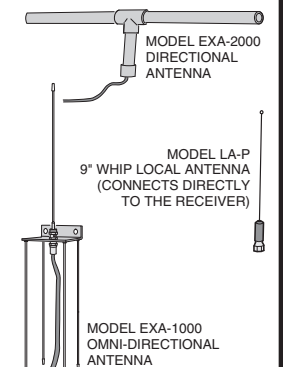

LINEAR LIMITED WARRANTY

This Linear product is warranted against defects in material and workmanship for twelve (12) months. **This warranty extends only to wholesale customers** who buy direct from Linear or through Linear's normal distribution channels. **Linear does not warrant this product to consumers.** Consumers should inquire from their selling dealer as to the nature of the dealer's warranty, if any. **There are no obligations or liabilities on the part of Linear LLC for consequential damages arising out of or in connection with use or performance of this product or other indirect damages with respect to loss of property, revenue, or profit, or cost of removal, installation, or reinstallation.** All implied warranties, including implied warranties for merchantability and implied warranties for fitness, are valid only until the warranty expires. **This Linear LLC Warranty is in lieu of all other warranties express or implied.**

All products returned for warranty service require a Return Product Authorization Number (RPA#). Contact Linear Technical Services at 1-800-421-1587 for an RPA# and other important details.

IMPORTANT !!!

Linear radio controls provide a reliable communications link and fill an important need in portable wireless signaling. However, there are some limitations which must be observed.

- * For U.S. installations only: The radios are required to comply with FCC Rules and Regulations as Part 15 devices. As such, they have limited transmitter power and therefore limited range.
- * A receiver cannot respond to more than one transmitted signal at a time and may be blocked by radio signals that occur on or near their operating frequencies, regardless of code settings.
- * Changes or modifications to the device may void FCC compliance.
- * Infrequently used radio links should be tested regularly to protect against undetected interference or fault.
- * A general knowledge of radio and its vagaries should be gained prior to acting as a wholesale distributor or dealer, and these facts should be communicated to the ultimate users.

Free Manuals Download Website

<http://myh66.com>

<http://usermanuals.us>

<http://www.somanuals.com>

<http://www.4manuals.cc>

<http://www.manual-lib.com>

<http://www.404manual.com>

<http://www.luxmanual.com>

<http://aubethermostatmanual.com>

Golf course search by state

<http://golfingnear.com>

Email search by domain

<http://emailbydomain.com>

Auto manuals search

<http://auto.somanuals.com>

TV manuals search

<http://tv.somanuals.com>