

# Power Over Ethernet Adapter Kit





# About This Guide

## Icon Descriptions

While reading through the User Guide you may see various icons that call attention to specific items. Below is a description of these icons:



**NOTE:** This check mark indicates that there is a note of interest and is something that you should pay special attention to while using the product.



**WARNING:** This exclamation point indicates that there is a caution or warning and it is something that could damage your property or product.



**WEB:** This globe icon indicates a noteworthy website address or e-mail address.

## Online Resources

Website addresses in this document are listed without **http://** in front of the address because most current web browsers do not require it. If you use an older web browser, you may have to add **http://** in front of the web address.

Resource	Website
Linksys	www.linksys.com
Linksys International	www.linksys.com/international
Glossary	www.linksys.com/glossary
Network Security	www.linksys.com/security

## Copyright and Trademarks



Linksys is a registered trademark or trademark of Cisco Systems, Inc. and/or its affiliates in the U.S. and certain other countries. Copyright © 2008 Cisco Systems, Inc. All rights reserved. Other brands and product names are trademarks or registered trademarks of their respective holders.



<b>Chapter 1: Product Overview</b>	<b>1</b>
Introduction . . . . .	1
Injector . . . . .	1
Splitter . . . . .	2
<b>Chapter 2: Connection</b>	<b>5</b>
Overview . . . . .	5
Power on a Device that Uses a Standard Power Adapter . . . . .	6
Power on a Device that Uses Inline Power . . . . .	7
<b>Appendix A: Specifications</b>	<b>9</b>
<b>Appendix B: Warranty Information</b>	<b>11</b>
Limited Warranty . . . . .	11
<b>Appendix C: Regulatory Information</b>	<b>13</b>
FCC Statement . . . . .	13
Safety Notices . . . . .	13
Industry Canada Statement . . . . .	14
Avis d'Industry Canada . . . . .	14
User Information for Consumer Products Covered by EU Directive 2002/96/EC on Waste Electric and Electronic Equipment (WEEE)	14

# Chapter 1: Product Overview

---

## Introduction

Thank you for choosing the Linksys Power Over Ethernet Adapter Kit, comprised of the Injector and Splitter. The Injector sends power and data over the Ethernet cable to the Splitter. Then the Splitter separates the data and power back into two cables and delivers them to the remotely located access point or other network device that requires a five-volt power input. The Injector can also be used by itself with any Power Over Ethernet (POE)-enabled network device that accepts 48 volts directly on a POE port.



**NOTE:** If your Linksys product uses a 12-volt power input, then you should use the 12-volt kit, model number: WAPPOE12.

## Injector

The Injector's built-in cable and ports are located on side panels.

### Injector's First Side Panel

The Power & Data OUT port is located on the Injector's first side panel.



**Power & Data OUT** This port allows you to connect the Injector to the Splitter or a network device that supports inline power. (You will use the included Ethernet network cable to make this connection.)

### Injector's Second Side Panel

The built-in Ethernet network cable and Power port are located on the Injector's second side panel.



**Power** The Power port is where you will connect the included adapter.

**Ethernet IN** The Injector has a built-in Ethernet network cable. You will connect this cable to one of the Ethernet network ports on your router or switch.

## Injector's LED

The Power LED is located on the top of the Injector.

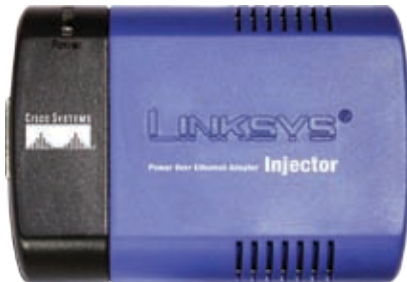

**Power** (Green) The Power LED lights up when the Injector is powered on and ready for use.

## Splitter

The Splitter's built-in cables and port are located on side panels.

## Splitter's First Side Panel

The Power & Data IN port is located on the Injector's first side panel.



**Power & Data IN** This port allows you to connect the Splitter to the Injector. (You will use the included Ethernet network cable to make this connection.)

## Splitter's Second Side Panel

The built-in Ethernet network and Power cables are located on the Splitter's second side panel.



**Ethernet OUT** The Splitter has a built-in Ethernet network cable. You will connect this cable to the Ethernet network port of your remotely located access point or other network device.

**Power** The Splitter has a built-in power cord. You will connect this cord to the Power port of your remotely located access point or other network device.

## Splitter's LED

The Splitter's LED is located on the top of the Splitter.



-  **Power** (Green) The Power LED lights up when the Splitter is powered on and ready for use.



# Chapter 2: Connection

## Overview

This chapter gives instructions on how to connect the Power Over Ethernet Kit. Once connected, the Kit will transmit data and power over the Ethernet network cable to your remotely located network device.

The diagram shows an example of how the Kit can be connected to a wired switch and a wireless access point.

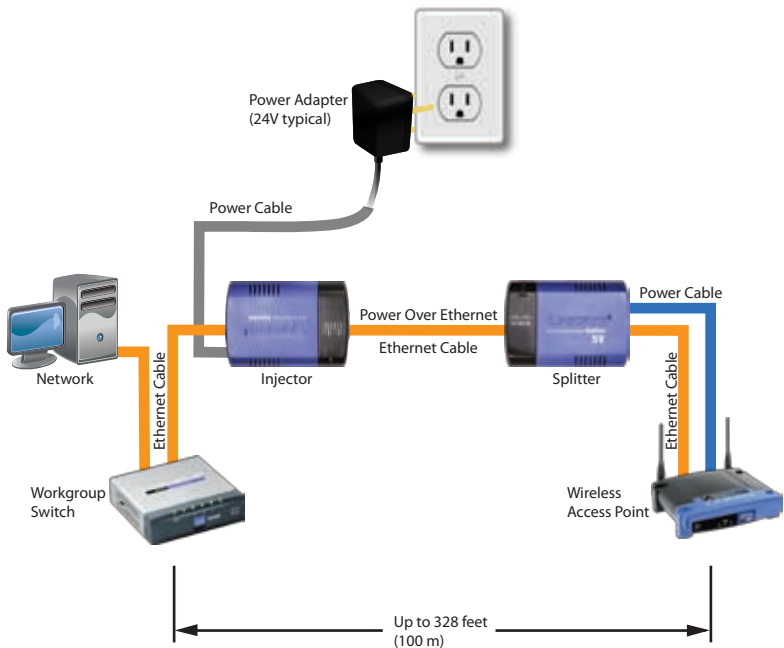

To connect the Kit to a device with a conventional power port, proceed to the section, "Power on a Device that Uses a Standard Power Adapter." To connect the Injector to a device that supports inline power, proceed to the section, "Power on a Device that Uses Inline Power."

## Power on a Device that Uses a Standard Power Adapter

Use the Injector and Splitter to power up a device that uses a standard power adapter. Follow these instructions:

1. Connect the Injector's built-in Ethernet network cable to your router, switch, or other network device.
2. Connect the Kit's included Ethernet network cable to the Injector's Power & Data OUT port.



---

**NOTE:** If this cable is not long enough, then you can use your own Ethernet network cable.

---

3. Then connect the other end to the Splitter's Power & Data IN port.



4. Connect the Splitter's built-in Ethernet network cable to the Ethernet port of your remotely located access point or other network device.
5. Connect the Splitter's Power cord to the Power port of your remotely located access point or other network device.



**NOTE:** If the plug of the Splitter's Power cord does not fit into your network device, then use the included barrel jack adapter. Plug the Splitter's Power cord into the jack end, and plug the other end of the barrel jack adapter into the Power port of your network device.



6. Connect the Kit's power adapter to the Injector, and plug the other end into an electrical outlet or surge protector.



**Congratulations! The installation of the Power Over Ethernet Kit is complete.**

## Power on a Device that Uses Inline Power

Use only the Injector to power up a device that supports inline power. Follow these instructions:

1. Connect the Injector's built-in Ethernet network cable to your router, switch, or other network device.
2. Connect the Kit's included Ethernet network cable to the Injector's Power & Data OUT port.



3. Then connect the other end to the Ethernet port of your remotely located access point or other network device.



---

**NOTE:** If the plug of the Splitter's Power cord does not fit into your network device, then use the included barrel jack adapter. Plug the Splitter's Power cord into the jack end, and plug the other end of the barrel jack adapter into the Power port of your network device.

---

4. Connect the Kit's power adapter to the Injector, and plug the other end into an electrical outlet or surge protector.



**Congratulations! The installation of the Power Over Ethernet Kit is complete.**

# Appendix A: Specifications

---

Model	WAPPOE
Standards	IEEE 802.3, 802.3u
Ports	Injector: Power, Data and Power OUT Splitter: Data and Power IN
Cabling Type	Category 5 or better
LED	Power

## Environmental

Dimensions	3.15" x 0.87" x 2.20" (80 x 22 x 56 mm)
Weight	2.65 oz. (0.075 kg)
Power	External Adapter: 100~240VAC, Injector 48VDC
Certification	FCC Class B
Operating Temp.	32 to 104°F (0 to 40°C)
Storage Temp.	-4 to 158°F (-20 to 70°C)
Operating Humidity	10 to 85% Noncondensing
Storage Humidity	5 to 90% Noncondensing



# Appendix B: Warranty Information

---

## Limited Warranty

Linksys warrants this Linksys hardware product against defects in materials and workmanship under normal use for the Warranty Period, which begins on the date of purchase by the original end-user purchaser and lasts for the period specified below:

- One (1) year for new product
- Ninety (90) days for refurbished product

This limited warranty is non-transferable and extends only to the original end-user purchaser. Your exclusive remedy and Linksys' entire liability under this limited warranty will be for Linksys, at its option, to (a) repair the product with new or refurbished parts, (b) replace the product with a reasonably available equivalent new or refurbished Linksys product, or (c) refund the purchase price of the product less any rebates. Any repaired or replacement products will be warranted for the remainder of the original Warranty Period or thirty (30) days, whichever is longer. All products and parts that are replaced become the property of Linksys.

## Exclusions and Limitations

This limited warranty does not apply if: (a) the product assembly seal has been removed or damaged, (b) the product has been altered or modified, except by Linksys, (c) the product damage was caused by use with non-Linksys products, (d) the product has not been installed, operated, repaired, or maintained in accordance with instructions supplied by Linksys, (e) the product has been subjected to abnormal physical or electrical stress, misuse, negligence, or accident, (f) the serial number on the Product has been altered, defaced, or removed, or (g) the product is supplied or licensed for beta, evaluation, testing or demonstration purposes for which Linksys does not charge a purchase price or license fee.

ALL SOFTWARE PROVIDED BY LINKSYS WITH THE PRODUCT, WHETHER FACTORY LOADED ON THE PRODUCT OR CONTAINED ON MEDIA ACCOMPANYING THE PRODUCT, IS PROVIDED "AS IS" WITHOUT WARRANTY OF ANY KIND. Without limiting the foregoing, Linksys does not warrant that the operation of the product or software will be uninterrupted or error free. Also, due to the continual development of new techniques for intruding upon and attacking networks, Linksys does not warrant that the product, software or any equipment, system or network on which the product or software is used will be free of vulnerability to intrusion or attack. The product may include or be bundled with third party software or service offerings. This limited warranty shall not apply to such third party software or service offerings. This limited warranty does not guarantee any continued availability of a third party's service for which this product's use or operation may require.

TO THE EXTENT NOT PROHIBITED BY LAW, ALL IMPLIED WARRANTIES AND CONDITIONS OF MERCHANTABILITY, SATISFACTORY QUALITY OR FITNESS FOR A PARTICULAR PURPOSE ARE LIMITED TO THE DURATION OF THE WARRANTY PERIOD. ALL OTHER EXPRESS OR IMPLIED

CONDITIONS, REPRESENTATIONS AND WARRANTIES, INCLUDING, BUT NOT LIMITED TO, ANY IMPLIED WARRANTY OF NON-INFRINGEMENT, ARE DISCLAIMED. Some jurisdictions do not allow limitations on how long an implied warranty lasts, so the above limitation may not apply to you. This limited warranty gives you specific legal rights, and you may also have other rights which vary by jurisdiction.

TO THE EXTENT NOT PROHIBITED BY LAW, IN NO EVENT WILL LINKSYS BE LIABLE FOR ANY LOST DATA, REVENUE OR PROFIT, OR FOR SPECIAL, INDIRECT, CONSEQUENTIAL, INCIDENTAL OR PUNITIVE DAMAGES, REGARDLESS OF THE THEORY OF LIABILITY (INCLUDING NEGLIGENCE), ARISING OUT OF OR RELATED TO THE USE OF OR INABILITY TO USE THE PRODUCT (INCLUDING ANY SOFTWARE), EVEN IF LINKSYS HAS BEEN ADVISED OF THE POSSIBILITY OF SUCH DAMAGES. IN NO EVENT WILL LINKSYS' LIABILITY EXCEED THE AMOUNT PAID BY YOU FOR THE PRODUCT. The foregoing limitations will apply even if any warranty or remedy provided under this limited warranty fails of its essential purpose. Some jurisdictions do not allow the exclusion or limitation of incidental or consequential damages, so the above limitation or exclusion may not apply to you.

## Obtaining Warranty Service

If you have a question about your product or experience a problem with it, please go to [www.linksys.com/support](http://www.linksys.com/support) where you will find a variety of online support tools and information to assist you with your product. If the product proves defective during the Warranty Period, contact Linksys Technical Support for instructions on how to obtain warranty service. The telephone number for Linksys Technical Support in your area can be found in the product User Guide and at [www.linksys.com](http://www.linksys.com). Have your product serial number and proof of purchase on hand when calling. A DATED PROOF OF ORIGINAL PURCHASE IS REQUIRED TO PROCESS WARRANTY CLAIMS. If you are requested to return your product, you will be given a Return Materials Authorization (RMA) number. You are responsible for properly packaging and shipping your product to Linksys at your cost and risk. You must include the RMA number and a copy of your dated proof of original purchase when returning your product. Products received without a RMA number and dated proof of original purchase will be rejected. Do not include any other items with the product you are returning to Linksys. Defective product covered by this limited warranty will be repaired or replaced and returned to you without charge. Customers outside of the United States of America and Canada are responsible for all shipping and handling charges, custom duties, VAT and other associated taxes and charges. Repairs or replacements not covered under this limited warranty will be subject to charge at Linksys' then-current rates.

## Technical Support

This limited warranty is neither a service nor a support contract. Information about Linksys' current technical support offerings and policies (including any fees for support services) can be found at: [www.linksys.com/support](http://www.linksys.com/support).

This limited warranty is governed by the laws of the jurisdiction in which the Product was purchased by you.

Please direct all inquiries to: Linksys, P.O. Box 18558, Irvine, CA 92623.



# Appendix C: Regulatory Information

---

## FCC Statement

This product has been tested and complies with the specifications for a Class B digital device, pursuant to Part 15 of the FCC Rules. These limits are designed to provide reasonable protection against harmful interference in a residential installation. This equipment generates, uses, and can radiate radio frequency energy and, if not installed and used according to the instructions, may cause harmful interference to radio communications. However, there is no guarantee that interference will not occur in a particular installation. If this equipment does cause harmful interference to radio or television reception, which is found by turning the equipment off and on, the user is encouraged to try to correct the interference by one or more of the following measures:

- Reorient or relocate the receiving antenna
- Increase the separation between the equipment or devices
- Connect the equipment to an outlet other than the receiver's
- Consult a dealer or an experienced radio/TV technician for assistance

## Safety Notices

Caution: To reduce the risk of fire, use only No.26 AWG or larger telecommunication line cord.

Do not use this product near water, for example, in a wet basement or near a swimming pool.

Avoid using this product during an electrical storm. There may be a remote risk of electric shock from lightning.



---

**WARNING:** This product contains lead, known to the State of California to cause cancer, and birth defects or other reproductive harm. Wash hands after handling.

---

## Industry Canada Statement

This Class B digital apparatus complies with Canadian ICES-003.

Operation is subject to the following two conditions:

1. This device may not cause interference and
2. This device must accept any interference, including interference that may cause undesired operation of the device.

## Avis d'Industrie Canada

Cet appareil est conforme à la norme NMB003 d'Industrie Canada.

Le fonctionnement est soumis aux conditions suivantes :

1. Ce périphérique ne doit pas causer d'interférences;
2. Ce périphérique doit accepter toutes les interférences reçues, y compris celles qui risquent d'entraîner un fonctionnement indésirable.

## User Information for Consumer Products Covered by EU Directive 2002/96/EC on Waste Electric and Electronic Equipment (WEEE)

This document contains important information for users with regards to the proper disposal and recycling of Linksys products. Consumers are required to comply with this notice for all electronic products bearing the following symbol:



## English - Environmental Information for Customers in the European Union

European Directive 2002/96/EC requires that the equipment bearing this symbol  on the product and/or its packaging must not be disposed of with unsorted municipal waste. The symbol indicates that this product should be disposed of separately from regular household waste streams. It is your responsibility to dispose of this and other electric and electronic equipment via designated collection facilities appointed by the government or local authorities. Correct disposal and recycling will help prevent potential negative consequences to the environment and human health. For more detailed information about the disposal of your old equipment, please contact your local authorities, waste disposal service, or the shop where you purchased the product.

## Български (Bulgarian) - Информация относно опазването на околната среда за потребители в Европейския съюз

Европейска директива 2002/96/ЕС изисква уредите, носещи този символ  върху изделието и/или опаковката му, да не се изхвърлят с несортирани битови отпадъци. Символът обозначава, че изделието трябва да се изхвърля отделно от сметосъбирането на обикновените битови отпадъци. Ваша е отговорността този и другите електрически и електронни уреди да се изхвърлят в предварително определени от държавните или общински органи специализирани пунктове за събиране. Правилното изхвърляне и рециклиране ще спомогнат да се предотвратят евентуални вредни за околната среда и здравето на населението последствия. За по-подробна информация относно изхвърлянето на вашите стари уреди се обърнете към местните власти, службите за сметосъбиране или магазина, от който сте закупили уреда.

## Čeština (Czech) - Informace o ochraně životního prostředí pro zákazníky v zemích Evropské unie

Evropská směrnice 2002/96/ES zakazuje, aby zařízení označené tímto symbolem  na produktu anebo na obalu bylo likvidováno s netříděným komunálním odpadem. Tento symbol udává, že daný produkt musí být likvidován odděleně od běžného komunálního odpadu. Odpovídáte za likvidaci tohoto produktu a dalších elektrických a elektronických zařízení prostřednictvím určených sběrných míst stanovených vládou nebo místními úřady. Správná likvidace a recyklace pomáhá předcházet potenciálním negativním dopadům na životní prostředí a lidské zdraví. Podrobnější informace o likvidaci starého vybavení si laskavě vyžádejte od místních úřadů, podniku zabývajícího se likvidací komunálních odpadů nebo obchodu, kde jste produkt zakoupili.

### Dansk (Danish) - Miljøinformation for kunder i EU

EU-direktiv 2002/96/EF kræver, at udstyr der bærer dette symbol  på produktet og/eller emballagen ikke må bortskaffes som usorteret kommunalt affald. Symbolet betyder, at dette produkt skal bortskaffes adskilt fra det almindelige husholdningsaffald. Det er dit ansvar at bortskaffe dette og andet elektrisk og elektronisk udstyr via bestemte indsamlingssteder udpeget af staten eller de lokale myndigheder. Korrekt bortskaffelse og genvinding vil hjælpe med til at undgå mulige skader for miljøet og menneskers sundhed. Kontakt venligst de lokale myndigheder, renovationstjenesten eller den butik, hvor du har købt produktet, angående mere detaljeret information om bortskaffelse af dit gamle udstyr.

### Deutsch (German) - Umweltinformation für Kunden innerhalb der Europäischen Union

Die Europäische Richtlinie 2002/96/EC verlangt, dass technische Ausrüstung, die direkt am Gerät und/oder an der Verpackung mit diesem Symbol versehen ist , nicht zusammen mit unsortiertem Gemeindeabfall entsorgt werden darf. Das Symbol weist darauf hin, dass das Produkt von regulärem Haushaltsmüll getrennt entsorgt werden sollte. Es liegt in Ihrer Verantwortung, dieses Gerät und andere elektrische und elektronische Geräte über die dafür zuständigen und von der Regierung oder örtlichen Behörden dazu bestimmten Sammelstellen zu entsorgen. Ordnungsgemäßes Entsorgen und Recyclen trägt dazu bei, potentielle negative Folgen für Umwelt und die menschliche Gesundheit zu vermeiden. Wenn Sie weitere Informationen zur Entsorgung Ihrer Altgeräte benötigen, wenden Sie sich bitte an die örtlichen Behörden oder städtischen Entsorgungsdienste oder an den Händler, bei dem Sie das Produkt erworben haben.

### Eesti (Estonian) - Keskkonnaalane informatsioon Euroopa Liidus asuvatele klientidele

Euroopa Liidu direktiivi 2002/96/EÜ nõuete kohaselt on seadmeid, millel on tootel või pakendil käesolev sümbol , keelatud kõrvaldada koos sorteerimata olmejäätmetega. See sümbol näitab, et toode tuleks kõrvaldada eraldi tavalistest olmejäätmevoogudest. Olete kohustatud kõrvaldama käesoleva ja ka muud elektri- ja elektroonikaseadmed riigi või kohalike ametiasutuste poolt ette nähtud kogumispunktide kaudu. Seadmete korrektne kõrvaldamine ja ringlussevõtt aitab vältida võimalikke negatiivseid tagajärgi keskkonnale ning inimeste tervisele. Vanade seadmete kõrvaldamise kohta täpsema informatsiooni saamiseks võtke palun ühendust kohalike ametiasutustega, jäätmekäitlusfirmaga või kauplusega, kust te toote ostsite.

## **Español (Spanish) - Información medioambiental para clientes de la Unión Europea**

La Directiva 2002/96/CE de la UE exige que los equipos que lleven este símbolo  en el propio aparato y/o en su embalaje no deben eliminarse junto con otros residuos urbanos no seleccionados. El símbolo indica que el producto en cuestión debe separarse de los residuos domésticos convencionales con vistas a su eliminación. Es responsabilidad suya desechar este y cualesquiera otros aparatos eléctricos y electrónicos a través de los puntos de recogida que ponen a su disposición el gobierno y las autoridades locales. Al desechar y reciclar correctamente estos aparatos estará contribuyendo a evitar posibles consecuencias negativas para el medio ambiente y la salud de las personas. Si desea obtener información más detallada sobre la eliminación segura de su aparato usado, consulte a las autoridades locales, al servicio de recogida y eliminación de residuos de su zona o pregunte en la tienda donde adquirió el producto.

## **Ελληνικά (Greek) - Στοιχεία περιβαλλοντικής προστασίας για πελάτες εντός της Ευρωπαϊκής Ένωσης**

Η Κοινοτική Οδηγία 2002/96/EC απαιτεί ότι ο εξοπλισμός ο οποίος φέρει αυτό το σύμβολο  στο προϊόν και/ή στη συσκευασία του δεν πρέπει να απορρίπτεται μαζί με τα μικτά κοινοτικά απορρίμματα. Το σύμβολο υποδεικνύει ότι αυτό το προϊόν θα πρέπει να απορρίπτεται ξεχωριστά από τα συνήθη οικιακά απορρίμματα. Είστε υπεύθυνος για την απόρριψη του παρόντος και άλλου ηλεκτρικού και ηλεκτρονικού εξοπλισμού μέσω των καθορισμένων εγκαταστάσεων συγκέντρωσης απορριμμάτων οι οποίες παρέχονται από το κράτος ή τις αρμόδιες τοπικές αρχές. Η σωστή απόρριψη και ανακύκλωση συμβάλλει στην πρόληψη πιθανών αρνητικών συνεπειών για το περιβάλλον και την υγεία. Για περισσότερες πληροφορίες σχετικά με την απόρριψη του παλιού σας εξοπλισμού, παρακαλώ επικοινωνήστε με τις τοπικές αρχές, τις υπηρεσίες απόρριψης ή το κατάστημα από το οποίο αγοράσατε το προϊόν.

## **Français (French) - Informations environnementales pour les clients de l'Union européenne**

La directive européenne 2002/96/CE exige que l'équipement sur lequel est apposé ce symbole  sur le produit et/ou son emballage ne soit pas jeté avec les autres ordures ménagères. Ce symbole indique que le produit doit être éliminé dans un circuit distinct de celui pour les déchets des ménages. Il est de votre responsabilité de jeter ce matériel ainsi que tout autre matériel électrique ou électronique par les moyens de collecte indiqués par le gouvernement et les pouvoirs publics des collectivités territoriales. L'élimination et le recyclage en bonne et due forme ont pour but de lutter contre l'impact néfaste potentiel de ce type de produits sur l'environnement et la santé publique. Pour plus d'informations sur le mode d'élimination de votre ancien équipement, veuillez prendre contact avec les pouvoirs publics locaux, le service de traitement des déchets, ou l'endroit où vous avez acheté le produit.

### **Italiano (Italian) - Informazioni relative all'ambiente per i clienti residenti nell'Unione Europea**

La direttiva europea 2002/96/EC richiede che le apparecchiature contrassegnate con questo simbolo  sul prodotto e/o sull'imballaggio non siano smaltite insieme ai rifiuti urbani non differenziati. Il simbolo indica che questo prodotto non deve essere smaltito insieme ai normali rifiuti domestici. È responsabilità del proprietario smaltire sia questi prodotti sia le altre apparecchiature elettriche ed elettroniche mediante le specifiche strutture di raccolta indicate dal governo o dagli enti pubblici locali. Il corretto smaltimento ed il riciclaggio aiuteranno a prevenire conseguenze potenzialmente negative per l'ambiente e per la salute dell'essere umano. Per ricevere informazioni più dettagliate circa lo smaltimento delle vecchie apparecchiature in Vostro possesso, Vi invitiamo a contattare gli enti pubblici di competenza, il servizio di smaltimento rifiuti o il negozio nel quale avete acquistato il prodotto.

### **Latviešu valoda (Latvian) - Ekoloģiska informācija klientiem Eiropas Savienības jurisdikcijā**

Direktīvā 2002/96/EK ir prasība, ka aprīkojumu, kam pievienota zīme  uz paša izstrādājuma vai uz tā iesaiņojuma, nedrīkst izmest nešķīrotā veidā kopā ar komunālajiem atkritumiem (tiem, ko rada vietēji iedzīvotāji un uzņēmumi). Šī zīme nozīmē to, ka šī ierīce ir jāizmet atkritumos tā, lai tā nenonāktu kopā ar parastiem mājāsaimniecības atkritumiem. Jūsu pienākums ir šo un citas elektriskas un elektroniskas ierīces izmest atkritumos, izmantojot īpašus atkritumu savākšanas veidus un līdzekļus, ko nodrošina valsts un pašvaldību iestādes. Ja izmešana atkritumos un pārstrāde tiek veikta pareizi, tad mazinās iespējamais kaitējums dabai un cilvēku veselībai. Sīkākas ziņas par novecojuša aprīkojuma izmešanu atkritumos jūs varat saņemt vietējā pašvaldībā, atkritumu savākšanas dienestā, kā arī veikalā, kur iegādājāties šo izstrādājumu.

### **Lietuvškai (Lithuanian) - Aplinkosaugos informacija, skirta Europos Sąjungos vartotojams**

Europos direktyva 2002/96/EC numato, kad įrangos, kuri ir  kurios pakuotė yra pažymėta šiuo simboliu (įveskite simbolį), negalima šalinti kartu su nerūšiuotomis komunalinėmis atliekomis. Šis simbolis rodo, kad gaminį reikia šalinti atskirai nuo bendro buitinių atliekų srauto. Jūs privalote užtikrinti, kad ši ir kita elektros ar elektroninė įranga būtų šalinama per tam tikras nacionalinės ar vietinės valdžios nustatytas atliekų rinkimo sistemas. Tinkamai šalinant ir perdirbant atliekas, bus išvengta galimos žalos aplinkai ir žmonių sveikatai. Daugiau informacijos apie jūsų senos įrangos šalinimą gali pateikti vietinės valdžios institucijos, atliekų šalinimo tarnybos arba parduotuvės, kuriose įsigijote tą gaminį.

### **Malti (Maltese) - Informazzjoni Ambjentali għal Kliġenti fl-Unjoni Ewropea**

Id-Direttiva Ewropea 2002/96/KE titlob li t-tagħmir li jkun fih is-simbolu  fuq il-prodott u/jew fuq l-ippakkjar ma jistax jintrema ma' skart municijali li ma għix isseparat. Is-simbolu jindika li dan il-prodott għandu jintrema separatament minn ma' l-iskart domestiku regolari. Hija responsabbiltà tiegħek li tarmi dan it-tagħmir u kull tagħmir ieħor ta' l-elettriku u elettroniku permezz ta' facilitajiet ta' ġbir appuntati apposta mill-gvern jew mill-awtoritajiet lokali. Ir-rimi b'mod korrett u r-riċiklaġġ għin jipprevjeni konsegwenzi negattivi potenzjali għall-ambjent u għas-saħħa tal-bniedem. Għal aktar informazzjoni dettaljata dwar ir-rimi tat-tagħmir antik tiegħek, jekk jogħġbok ikkuntattja lill-awtoritajiet lokali tiegħek, is-servizzi għar-rimi ta' l-iskart, jew il-ħanut minn fejn xtrajt il-prodott.

### **Magyar (Hungarian) - Környezetvédelmi információ az európai uniós vásárlók számára**

A 2002/96/EC számú európai uniós irányelv megkívánja, hogy azokat a termékeket, amelyeken, és/vagy amelyek csomagolásán az alábbi címke  megjelenik, tilos a többi szelektálatlan lakossági hulladékkal együtt kidobni. A címke azt jelöli, hogy az adott termék kidobásakor a szokványos háztartási hulladékelszállítási rendszerektől elkülönített eljárást kell alkalmazni. Az Ön felelőssége, hogy ezt, és más elektromos és elektronikus berendezéseit a kormányzati vagy a helyi hatóságok által kijelölt gyűjtőrendszereken keresztül számolja fel. A megfelelő hulladékfeldolgozás segít a környezetre és az emberi egészségre potenciálisan ártalmas negatív hatások megelőzésében. Ha elavult berendezéseinek felszámolásához további részletes információra van szüksége, kérjük, lépjen kapcsolatba a helyi hatóságokkal, a hulladékfeldolgozási szolgálattal, vagy azzal üzlettel, ahol a terméket vásárolta.

### **Nederlands (Dutch) - Milieu-informatie voor klanten in de Europese Unie**

De Europese Richtlijn 2002/96/EC schrijft voor dat apparatuur die is voorzien van dit symbool  op het product of de verpakking, niet mag worden ingezameld met niet-gescheiden huishoudelijk afval. Dit symbool geeft aan dat het product apart moet worden ingezameld. U bent zelf verantwoordelijk voor de vernietiging van deze en andere elektrische en elektronische apparatuur via de daarvoor door de landelijke of plaatselijke overheid aangewezen inzamelingskanalen. De juiste vernietiging en recycling van deze apparatuur voorkomt mogelijke negatieve gevolgen voor het milieu en de gezondheid. Voor meer informatie over het vernietigen van uw oude apparatuur neemt u contact op met de plaatselijke autoriteiten of afvalverwerkingsdienst, of met de winkel waar u het product hebt aangeschaft.

**Norsk (Norwegian) - Miljøinformasjon for kunder i EU**

EU-direktiv 2002/96/EF krever at utstyr med følgende symbol  avbildet på produktet og/eller pakningen, ikke må kastes sammen med usortert avfall. Symbolet indikerer at dette produktet skal håndteres atskilt fra ordinær avfallsinnsamling for husholdningsavfall. Det er ditt ansvar å kvitte deg med dette produktet og annet elektrisk og elektronisk avfall via egne innsamlingsordninger slik myndighetene eller kommunene bestemmer. Korrekt avfallshåndtering og gjenvinning vil være med på å forhindre mulige negative konsekvenser for miljø og helse. For nærmere informasjon om håndtering av det kasserte utstyret ditt, kan du ta kontakt med kommunen, en innsamlingsstasjon for avfall eller butikken der du kjøpte produktet.

**Polski (Polish) - Informacja dla klientów w Unii Europejskiej o przepisach dotyczących ochrony środowiska**

Dyrektywa Europejska 2002/96/EC wymaga, aby sprzęt oznaczony symbolem  znajdującym się na produkcie i/lub jego opakowaniu nie był wyrzucany razem z innymi niesortowanymi odpadami komunalnymi. Symbol ten wskazuje, że produkt nie powinien być usuwany razem ze zwykłymi odpadami z gospodarstw domowych. Na Państwu spoczywa obowiązek wyrzucania tego i innych urządzeń elektrycznych oraz elektronicznych w punktach odbioru wyznaczonych przez władze krajowe lub lokalne. Pozbywanie się sprzętu we właściwy sposób i jego recykling pomogą zapobiec potencjalnie negatywnym konsekwencjom dla środowiska i zdrowia ludzkiego. W celu uzyskania szczegółowych informacji o usuwaniu starego sprzętu, prosimy zwrócić się do lokalnych władz, służb oczyszczania miasta lub sklepu, w którym produkt został nabyty.

**Português (Portuguese) - Informação ambiental para clientes da União Europeia**

A Directiva Europeia 2002/96/CE exige que o equipamento que exibe este símbolo  no produto e/ou na sua embalagem não seja eliminado junto com os resíduos municipais não separados. O símbolo indica que este produto deve ser eliminado separadamente dos resíduos domésticos regulares. É da sua responsabilidade eliminar este e qualquer outro equipamento eléctrico e electrónico através das instalações de recolha designadas pelas autoridades governamentais ou locais. A eliminação e reciclagem correctas ajudarão a prevenir as consequências negativas para o ambiente e para a saúde humana. Para obter informações mais detalhadas sobre a forma de eliminar o seu equipamento antigo, contacte as autoridades locais, os serviços de eliminação de resíduos ou o estabelecimento comercial onde adquiriu o produto.



### **Română (Romanian) - Informații de mediu pentru clienții din Uniunea Europeană**

Directiva europeană 2002/96/CE impune ca echipamentele care prezintă acest simbol  pe produs și/sau pe ambalajul acestuia să nu fie casate împreună cu gunoiul menajer municipal. Simbolul indică faptul că acest produs trebuie să fie casat separat de gunoiul menajer obișnuit. Este responsabilitatea dvs. să casați acest produs și alte echipamente electrice și electronice prin intermediul unităților de colectare special desemnate de guvern sau de autoritățile locale. Casarea și reciclarea corecte vor ajuta la prevenirea potențialelor consecințe negative asupra sănătății mediului și a oamenilor. Pentru mai multe informații detaliate cu privire la casarea acestui echipament vechi, contactați autoritățile locale, serviciul de salubritate sau magazinul de la care ați achiziționat produsul.

### **Slovenčina (Slovak) - Informácie o ochrane životného prostredia pre zákazníkov v Európskej únii**

Podľa európskej smernice 2002/96/ES zariadenie s týmto symbolom  na produkte a/alebo jeho balení nesmie byť likvidované spolu s netriedeným komunálnym odpadom. Symbol znamená, že produkt by sa mal likvidovať oddelene od bežného odpadu z domácností. Je vašou povinnosťou likvidovať toto i ostatné elektrické a elektronické zariadenia prostredníctvom špecializovaných zberných zariadení určených vládou alebo miestnymi orgánmi. Správna likvidácia a recyklácia pomôže zabrániť prípadným negatívnym dopadom na životné prostredie a zdravie ľudí. Ak máte záujem o podrobnejšie informácie o likvidácii starého zariadenia, obráťte sa, prosím, na miestne orgány, organizácie zaoberajúce sa likvidáciou odpadov alebo obchod, v ktorom ste si produkt zakúpili.

### **Slovenčina (Slovene) - Okoljske informacije za stranke v Evropski uniji**

Evropska direktiva 2002/96/EC prepoveduje odlaganje opreme, označene s tem simbolom  – na izdelku in/ali na embalaži – med običajne, nerazvrščene odpadke. Ta simbol opozarja, da je treba izdelek odvreči ločeno od preostalih gospodinjskih odpadkov. Vaša odgovornost je, da to in preostalo električno in elektronsko opremo odnesete na posebna zbirališča, ki jih določijo državne ustanove ali lokalna uprava. S pravilnim odlaganjem in recikliranjem boste preprečili morebitne škodljive vplive na okolje in zdravje ljudi. Če želite izvedeti več o odlaganju stare opreme, se obrnite na lokalno upravo, odpad ali trgovino, kjer ste izdelek kupili.

**Suomi (Finnish) - Ympäristöä koskevia tietoja EU-alueen asiakkaille**

EU-direktiivi 2002/96/EY edellyttää, että jos laitteistossa on tämä symboli  itse tuotteessa ja/tai sen pakkauksessa, laitteistoa ei saa hävittää lajittelemattoman yhdyskuntajätteen mukana. Symboli merkitsee sitä, että tämä tuote on hävitettävä erillään tavallisesta kotitalousjätteestä. Sinun vastuullasi on hävittää tämä elektroniikkatuote ja muut vastaavat elektroniikkatuotteet viemällä tuote tai tuotteet viranomaisten määräämään keräyspisteeseen. Laitteiston oikea hävittäminen estää mahdolliset kielteiset vaikutukset ympäristöön ja ihmisten terveyteen. Lisätietoja vanhan laitteiston oikeasta hävitystavasta saa paikallisilta viranomaisilta, jätteenhävityspalvelusta tai siitä myymälästä, josta ostit tuotteen.

**Svenska (Swedish) - Miljöinformation för kunder i Europeiska unionen**

Det europeiska direktivet 2002/96/EC kräver att utrustning med denna symbol  på produkten och/eller förpackningen inte får kastas med osorterat kommunalt avfall. Symbolen visar att denna produkt bör kastas efter att den avskiljts från vanligt hushållsavfall. Det faller på ditt ansvar att kasta denna och annan elektrisk och elektronisk utrustning på fastställda insamlingsplatser utsedda av regeringen eller lokala myndigheter. Korrekt kassering och återvinning skyddar mot eventuella negativa konsekvenser för miljön och personhälsa. För mer detaljerad information om kassering av din gamla utrustning kontaktar du dina lokala myndigheter, avfallshanteringen eller butiken där du köpte produkten.



---

**WEB:** For additional information, visit [www.linksys.com](http://www.linksys.com)

---



**LINKSYS®**

A Division of Cisco

[www.linksys.com](http://www.linksys.com)

## Free Manuals Download Website

<http://myh66.com>

<http://usermanuals.us>

<http://www.somanuals.com>

<http://www.4manuals.cc>

<http://www.manual-lib.com>

<http://www.404manual.com>

<http://www.luxmanual.com>

<http://aubethermostatmanual.com>

Golf course search by state

<http://golfingnear.com>

Email search by domain

<http://emailbydomain.com>

Auto manuals search

<http://auto.somanuals.com>

TV manuals search

<http://tv.somanuals.com>