

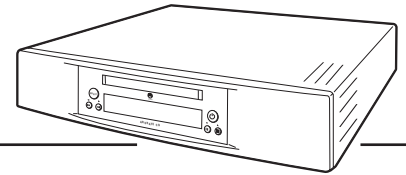

LINN

AKURATE CD

PLAYER



OWNER'S MANUAL
ENGLISH

Important Safety Instructions

Explanation of symbols used in this manual or on the rear/underside of the apparatus:



This symbol is intended to alert the user to the presence of uninsulated dangerous voltages within the enclosure of sufficient magnitude to cause electric shock.



This symbol is intended to alert the user to the presence of important operation, maintenance and servicing information in the instruction and service manuals.

For apparatus connected to the mains electricity supply

CAUTION

TO REDUCE THE RISK OF ELECTRIC SHOCK DO NOT REMOVE THE COVER.

NO USER SERVICEABLE PARTS INSIDE.

REFER SERVICING TO QUALIFIED SERVICE PERSONNEL.

REPLACE THE MAINS FUSE IN THE PLUG WITH ONE OF THE SAME TYPE AND RATING.

DISCONNECT SUPPLY CORD BEFORE CHANGING FUSE.

WARNING

TO REDUCE THE RISK OF FIRE OR ELECTRIC SHOCK DO NOT EXPOSE THIS APPARATUS TO RAIN OR MOISTURE. SHOCK HAZARD - DO NOT OPEN.

MAINS PLUGS

This apparatus is supplied with a non-rewireable mains plug for the intended country. Replacement mains leads can be obtained from your Linn retailer. Should you need to change the plug please dispose of it carefully. A plug with bared conductors is dangerous if engaged in a live socket.

The Brown wire must be connected to the Live (Line) supply pin.

The Blue wire must be connected to the Neutral supply pin.

The Green/Yellow wire must be connected to the Earth (Ground) supply pin.

Please contact your retailer or a competent electrician if you are in any doubt.



Refer to the rear or underside of the product for fuse and power consumption information.

General Safety Instructions

1. **Read these instructions.**
2. **Keep these instructions.**
3. **Heed all warnings.**
4. **Follow all instructions.**
5. **Do not use the apparatus near water.** for example near a bathtub, washbowl, kitchen sink, laundry tub, in a wet basement, near a swimming pool etc.
6. **Clean only with dry cloth.**
7. **Do not block any ventilation openings. Install in accordance with the manufacturer's instructions.** Site the apparatus so that its location or position does not interfere with its proper ventilation. For example, the apparatus should not be situated on a bed, sofa, rug, or similar surface that may block the ventilation openings, or placed in a built-in installation such as a bookcase or cabinet that may impede the flow of air through the ventilation openings.
8. **Do not install near any heat sources such as radiators, heat registers, stoves, or other apparatus (including amplifiers) that produce heat.**
9. **Do not defeat the safety purpose of the polarised or grounding type plug.** A polarised plug has two blades with one wider than the other. A grounding type plug has two blades and a third grounding prong. The wide blade or the third prong is provided for your safety. If the provided plug does not fit into your outlet, consult an electrician for replacement of the obsolete outlet.
10. **Protect the power cord from being walked on or pinched particularly at plugs, convenience receptacles, and at the point where they exit from the apparatus.**
11. **Only use attachments/accessories specified by the manufacturer.**
12. **Use only with the stand, tripod, bracket, or table specified by the manufacturer, or sold with the apparatus.**
13. **Unplug this apparatus during lightning storms or when unused for long periods of time.**
14. **Refer all servicing to qualified service personnel.** Servicing is required when the apparatus has been damaged in any way, such as power-supply cord or plug has been damaged, liquid has been spilled or objects have fallen into the apparatus, the apparatus has been exposed to rain or moisture, does not operate normally, or has been dropped.
15. **Wall or ceiling mounting.** Mount the apparatus to a wall or ceiling only as recommended by the manufacturer.

16. **Power sources.** Connect the apparatus to a power supply only of the type described in the operating instructions or marked on the apparatus.
17. **Mains plug.** Use the mains plug to disconnect the apparatus from the mains supply. The mains plug must be accessible at all times. Use the mains switch (if applicable) when the apparatus is not in use.
18. **Power lines.** An outdoor antenna should be located away from power lines.
19. **Outdoor antenna grounding.** If an outdoor antenna is connected to the apparatus, ensure that the antenna system is grounded to provide some protection against voltage surges and static build up. In the USA see article 810 of the National Electrical Code ANSI/NFPA 70 concerning installation requirements.
20. **Telephone line.** Do not connect the apparatus to a telephone line except where specifically instructed to do so.
21. **Objects and liquid entry.** Do not let objects or liquids fall into the apparatus. Do not expose the apparatus to dripping or splashing. Do not place a vessel containing liquid on top of the apparatus.
22. **No naked flame sources, such as lighted candles, should be placed on the apparatus.**
23. **The apparatus has been designed for use in moderate and tropical climates.**

UK USERS PLEASE READ THIS IMPORTANT SAFETY INFORMATION

Fuse replacement

This appliance is fitted with a non-rewireable 13 amp mains plug. The plug contains a 5 amp fuse. If the fuse has blown it can be replaced as follows:

- a) Pull out the red fuse cover/carrier.
- b) Remove and dispose of the blown fuse.
- c) Fit a new 5 amp BS1362 approved fuse into the carrier and push the carrier back into the plug.

Always ensure the fuse cover is fitted. If the fuse cover is missing do not use the plug. Contact your Linn retailer to obtain a replacement fuse cover.

Fuses are for fire protection and do not protect against electric shock.

Mains plug replacement

Should your mains plug need replacing and you are competent to do this proceed as follows. If you are in doubt contact your Linn retailer or a competent electrician.

- a) Disconnect the plug from the mains supply.
- b) Cut off the plug and dispose of it safely. A plug with bared conductors is dangerous if engaged in a live socket.
- c) Only fit a 13 amp BS1363A approved plug with a 5 amp fuse.
- d) The cable wire colours or a letter will be marked at the connection points of most quality plugs.

Attach the wires securely to their respective points. The Brown wire must go to the Live pin, the Blue wire must go to the Neutral pin, and the Green/Yellow wire must go to the Earth pin.

- e) Before replacing the plug top ensure that the cable restraint is holding the outer sheath of the cable firmly and that the wires are correctly connected.

WARNING

THIS APPLIANCE MUST BE EARTHED.

CE Declaration of Conformity

Linn Products Ltd declare that this product is in conformance with the Low Voltage Directive 73/23/EEC and Electromagnetic Compatibility 89/336/EEC as amended by 92/31/EEC and 93/68/EEC.

The conformity of the designated product with the provisions of Directive number 73/23/EEC (LVD) is proved by full compliance with the following standards:

Standard number	Date of issue	Test type
EN60065	2002	General requirements Marking Hazardous radiation Heating under normal conditions Shock hazards under normal operating conditions Insulation requirements Fault conditions Mechanical strength Parts connected to the mains supply Components Terminal devices External flexible cords Electrical connections and mechanical fixings Protection against electric shock Stability and mechanical hazards Resistance to fire

The conformity of the designated product with the provisions of Directive number 89/336/EEC (EMC) is proved by full compliance with the following standards:

Standard number	Date of issue	Test type
EN55013	2001	Conducted emissions
EN55013	2001	Absorbed emissions
EN55020	2002	Immunity

FCC notice

Note:

This equipment has been tested and found to comply with the limits for a Class B digital device, pursuant to Part 15 of the FCC Rules. These limits are designed to provide reasonable protection against harmful interference in a residential installation. This equipment generates, uses and can radiate radio frequency energy and, if not installed and used in accordance with the instructions, may cause harmful interference to radio communications. However, there is no guarantee that interference will not occur in a particular installation. If this equipment does cause harmful interference to radio or television reception, which can be determined by turning the equipment off and on, the user is encouraged to try to correct the interference by one or more of the following measures:

- Reorient or relocate the receiving antenna.
- Increase the separation between the equipment and receiver.
- Connect the equipment into an outlet on a circuit different from that to which the receiver is connected.
- Consult the dealer or an experienced radio/TV technician for help.

Waste Electrical and Electronic Equipment (WEEE)

Directive

Directive 2002/96/EC of the European Parliament and of the Council

The symbol (right) is shown on this product. It indicates that the product should not be disposed of with regular household waste, but should be disposed of separately.

Electrical and electronic equipment can contain materials that are hazardous to the environment and human health and therefore should be disposed of at a designated waste facility or returned to your retailer for the appropriate recycling to take place (see www.linn.co.uk for further information).

If you wish to dispose of this product and the product still functions, please consider recycling/reusing it by donating it to a charity shop, selling it or part-exchanging it with your retailer.



Copyright and Acknowledgements

Copyright © 2007 Linn Products Ltd. First edition May 2007.

Linn Products Limited, Glasgow Road, Waterfoot, Eaglesham,
Glasgow, G76 0EQ, Scotland, United Kingdom.

All rights reserved. No part of this publication may be reproduced, stored in a retrieval system, or transmitted, in any form or by any means, electronic, mechanical, photocopying, recording, or otherwise, without the prior written permission of the publisher.

The content of this manual is furnished for information use only, is subject to change without notice, and should not be construed as a commitment by Linn Products Limited. Linn Products Limited assumes no responsibility or liability for any errors or inaccuracies that may appear in this manual.

Trade marks used in this publication: **Linn** and the **Linn logo** are registered trade marks of Linn Products Limited. **AKURATE** is a trade mark of Linn Products Limited.

"DTS" and "DTS 2+Digital Out" are trade marks of Digital Theater Systems, Inc.

"Dolby" and "Pro Logic" are trade marks of Dolby Laboratories.

"DVD Logo" is a trade mark of DVD Format/Logo Licensing Corporation.

Linn Products Limited disclaims any proprietary interest in trade marks and trade names other than its own.

Printed in the United Kingdom.

Pack 1318

Contents

Introduction	1		
Audio outputs	1	Disc navigation controls	11
Disc types	1	Skip track	11
Installation	2	Search	11
Unpacking	2	Fast scan	11
Positioning	2	Direct track access	12
Cleaning	2	Additional controls	12
Connecting	3	Repeat	12
Back panel	3	Shuffle	13
Connecting using analogue outputs	4	Program (Include/Exclude)	14
Connecting using digital outputs	4	User Options	15
Connecting to the mains supply	4	Table of user options	16
Front Panel and Handset	5	Technical Specifications	18
Front panel	5	Guarantee and Service	19
Handset	6		
Handset modes	7		
Operation	8		
Basic controls	8		
Standby mode	8		
Playing discs	8		
Display	9		
Playing SACDs	10		
Playing DVD-Audios	10		

Introduction

Over thirty years ago Linn was born out of a simple truth: the more accurately a system reproduces sound, the greater the impact it will have on the listener.

Linn's AKURATE CD is an advanced multi-format disc player that plays CDs, DTS Audio CDs, and high resolution SACD and DVD-Audio formats to an exceptional standard. The AKURATE CD delivers class-leading performance whichever format you play.

The AKURATE CD is the perfect partner for Linn's AKURATE KONTROL pre-amplifier and AKURATE power amplifier range. Add the AKURATE TUNER and AKURATE loudspeakers for a complete AKURATE System and experience the exceptional sound quality delivered by this dedicated music system.

Audio outputs

The AKURATE CD has analogue and digital outputs available for use with CD and DTS Audio CDs. Audio signals from SACDs and DVD-Audios are output as analogue only; there is no output for these disc types from the digital connectors. By default, the AKURATE CD is configured for two channel (stereo) output. However, configure the AKURATE CD as multi-channel and it will output six channels of analogue audio from SACD, DVD-Audios and DTS Audio CDs. Please see *Channel Setup* in *User Options* (page 17) for further information.

Disc types

Discs marked with the following logos are compatible with your AKURATE CD:



In addition, the AKURATE CD plays SACD and DVD-Audio discs.

Important:

Whilst every effort has been made to ensure compatibility with all approved disc types, it is impossible to guarantee the operation of every function of the Linn AKURATE CD that is on sale now or in the future.

We have tested many of the disc types that are currently available. Many discs that are on sale at this time do not conform to the published and accepted formal specifications. For this reason, we are unable to accept any responsibility for the player being unable to play any particular disc. If you have discs that do not play on the Linn AKURATE CD, which are subsequently found to play on other brands of player, then this does not imply that the Linn AKURATE CD is in any way at fault.

We welcome the receipt of all suspect discs as this may assist us in ensuring that the Linn AKURATE CD continues to develop but cannot accept discs from end users on the basis that we have made any warranty about being able to learn how to play them.

Novelty discs

Do not play irregularly shaped discs (heart-shaped, business card size, etc.) in the AKURATE CD as they may damage the player.

Installation

This chapter explains how to install the AKURATE CD player and how to connect it to a pre-amplifier or system controller.

Important:

It is strongly recommended that your AKURATE CD is installed and configured by an authorised Linn retailer.

Unpacking

The AKURATE CD is supplied with the following accessories:

- luminous handset
- 2 x AAA batteries for the handset
- 1 pair of black interconnect cables
- mains lead
- warranty pack
- this manual

We recommend that you retain all packaging in case you need to transport the AKURATE CD at a later date.

Positioning

You can position your AKURATE CD almost anywhere you find convenient (including in a 19" rack, for which a mounting kit is available – consult your retailer), but please consider the following points:

- The unit should be placed on a flat, stable and rigid surface.
- Do not position the unit where sunlight can shine (whether directly, diffused or reflected) on its display as the infra-red (IR) radiation in sunlight will be picked up by the unit's IR remote sensor and this can adversely affect its operation. Similarly, some electrical devices such as plasma TVs, fluorescent lights and energy saving lamps can emit IR which can likewise affect the operation.
- For best performance, do not stack the unit with other products. Ideally, position the unit on a shelf by itself or, if proximity to other products is unavoidable, positioning side-by-side is preferable to stacking.
- The unit should not be situated above, or otherwise directly adjacent to, sources of heat such as radiators, power amplifiers etc. Nor should it be enclosed in a cabinet with such devices.
- Allow at least 4" (10 cm) free space above and at each side of the unit.
- Do not block the vents on the product's casing.

Note:

Do not open the AKURATE CD's disc drawer if the unit is behind glass doors as this can damage the drawer's mechanism.

Cleaning

Disconnect the AKURATE CD from the power supply before cleaning. Remove dust and fingerprints with a soft, dry cloth. Avoid using domestic cleaning products on the unit.

Connecting

Back panel

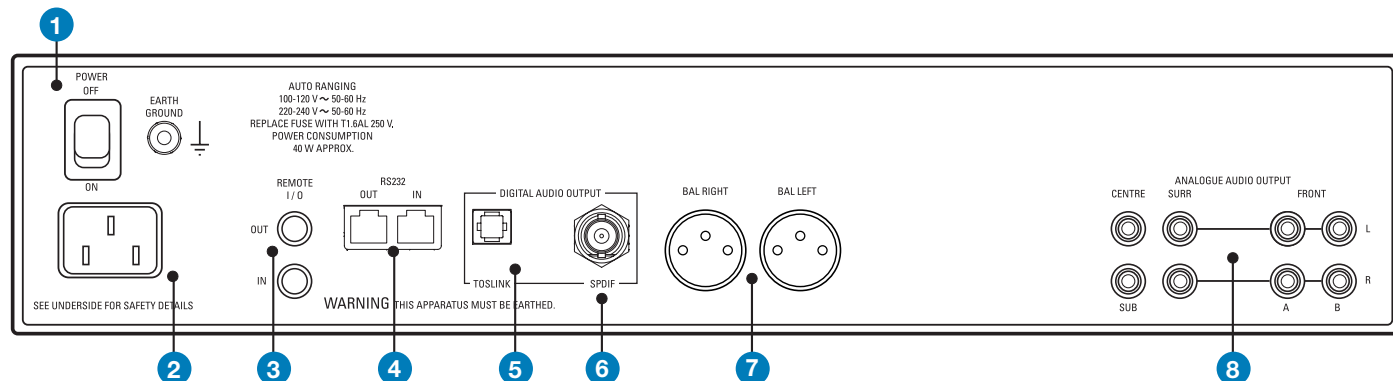

- 1 Power switch**
- 2 Mains input**
- 3 REMOTE OUT / IN** For installing the unit in a KNEKT system
- 4 RS232 OUT / IN** For operating the unit via a PC or touch-screen device
- 5 TOSLINK** For connection to a device with optical digital input capabilities
- 6 SPDIF** For connection to a device with coaxial digital input capabilities
- 7 BAL RIGHT / LEFT** Balanced XLR outputs
- 8 ANALOGUE AUDIO OUTPUT** Line outputs for connection to a pre-amplifier or system controller

Note:
Audio signals from SACDs and DVD-Audios are output as analogue only.
There is no output for these disc types via the digital outputs.



The AKURATE CD should be powered down then disconnected from the power supply before connecting or disconnecting any of the plugs on the back panel. If this is not done, you may generate surges which could damage the AKURATE CD or other components in your system.

Connecting using analogue outputs

Important:

Please ensure that the 'Channel Setup' user option is correctly set to match the outputs used. See *Channel Setup* in *User Options* (page 17) for more information.

Stereo or two-channel configuration:

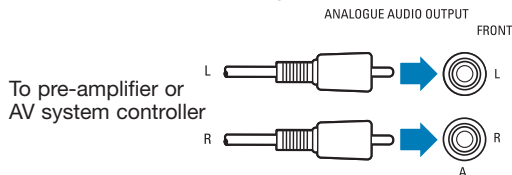

Multi-channel configuration:

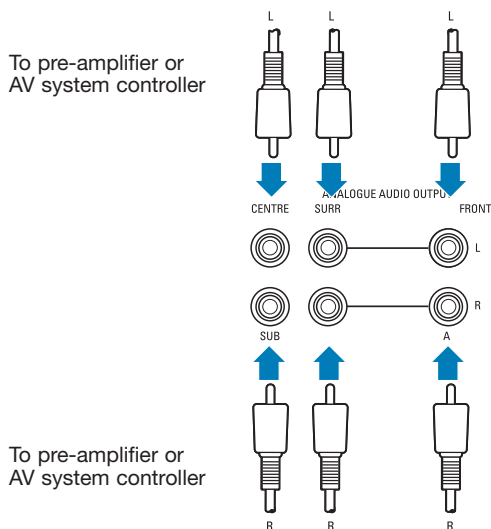

Connecting using digital outputs

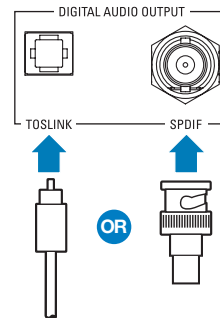

To pre-amplifier or AV system controller

Connecting to the mains supply

The unit can be connected to any worldwide mains voltage with no adjustment. It incorporates Automatic Voltage Selection (AVS) and the power supply automatically adjusts for the incoming mains supply.



This unit must be earthed. Use the earthed moulded mains lead supplied. Never use an unearthed plug or adaptor.

Front Panel and Handset

Front panel

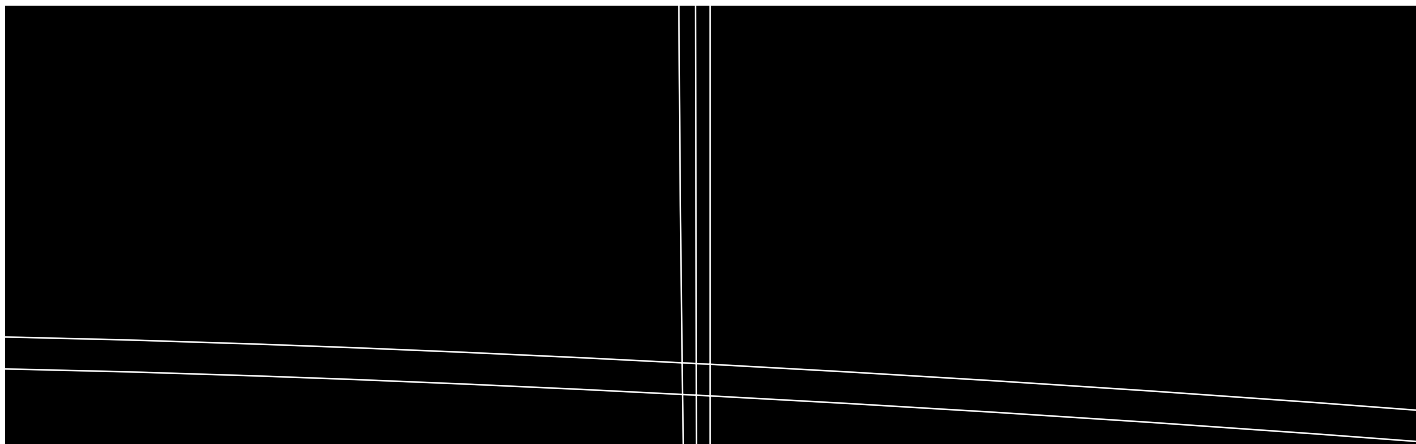

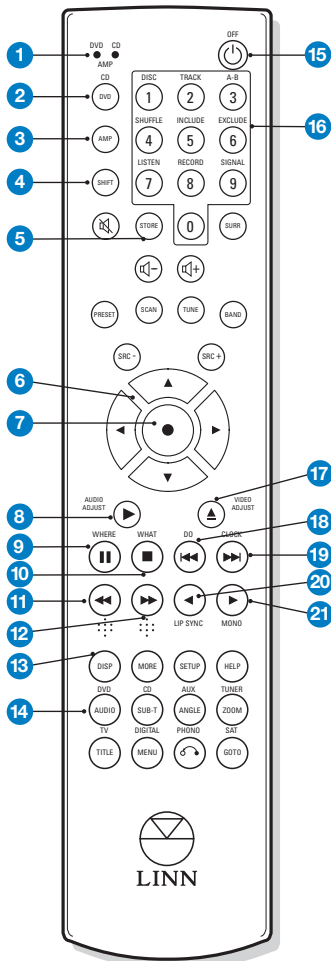

Handset

- 1 **LEDs** Indicate the mode of the handset when a key is pressed
- 2 **DVD, CD** Puts handset into Disc mode. Allows full operation of handset with AKURATE CD
- 3 **AMP** Puts handset into Amp mode (functions marked in blue above keys). Allows operation of an auxiliary Linn pre-amplifier
- 4 **SHIFT** Allows access to functions marked in red above keys
- 5 **STORE** Stores disc playback information
- 6 $\Delta/\nabla/\triangleleft/\triangleright$ For navigating setup menus and adjusting various features
- 7 ● Selects/executes options and certain commands
- 8 ► Plays a disc
- 9 || Pauses a disc
- 10 ■ Stops a disc
- 11 ◀◀ Fast search backwards
- 12 ▶▶ Fast search forwards
- 13 **DISP (display)** Changes the display on the front panel when playing a disc
- 14 **AUDIO** Cycles through available audio streams on a SACD
- 15 **OFF** Enters/exits standby mode. Sends 'off' (i.e. puts into standby) command to all available Linn equipment
- 16 **Digits 0-9, shifted functions** Numeric keys. Access to functions marked in red above keys
- 17 ▲ Opens/closes the disc drawer
- 18 ◀◀ Previous track selection
- 19 ▶▶ Next track selection
- 20 ◀ Fast scan backwards
- 21 ▶ Fast scan forwards

Keys and functions of the handset not listed above do not function with the AKURATE CD but may with other Linn products.

Handset modes

If your AKURATE CD is not responding as expected to handset keys, it is likely that the handset is not in the correct handset mode.

This handset has been designed to provide simpler, more intuitive control over a range of Linn products. In order to achieve this the handset can be operated in various handset modes which assign functionality to the keys based on the current mode. The handset mode is indicated by the LEDs at the top-left of the handset, which will light when a key is pressed.

If you are only using the handset with the AKURATE CD then you will not have to change handset mode. The handset should be used in Disc mode (the DVD or CD LEDs will light when a key is pressed)

Disc mode – press the **DVD** key to set the handset to Disc mode. The DVD functions will be assigned as the primary handset keys and the DVD LED will light when a key is pressed.

If you are using a Linn pre-amplifier or system controller with your AKURATE CD then you can use the same handset to operate both Linn products. For some functionality, you may have use the **DVD** and **AMP** buttons to switch between handset modes.

CD and DVD mode

The handset has two different Disc modes: DVD mode and CD mode. By default, the unit is configured to respond to relevant DVD commands (e.g. play, stop, skip etc.) as well as CD commands. If you are using the AKURATE CD alongside another DVD player then you may wish to set the AKURATE CD to ignore DVD commands, thereby allowing you to use this handset with both units, switching between CD and DVD mode as appropriate. See *DVD Commands* in *User Options* (page 17) for more information.

CD mode – press **SHIFT + DVD** to set the handset to CD mode. The CD functions will be assigned as the primary handset keys and the CD LED will light when a key is pressed.

Operation

Basic controls

This section describes how to play discs on the AKURATE CD and explains basic controls.

Important:

Press **DVD** on the handset. This puts the handset into Disc mode. The handset should be in Disc mode when operating your AKURATE CD. You should only have to do this once if you are only using the handset with the AKURATE CD. See *Handset modes* (page 7) for more information.

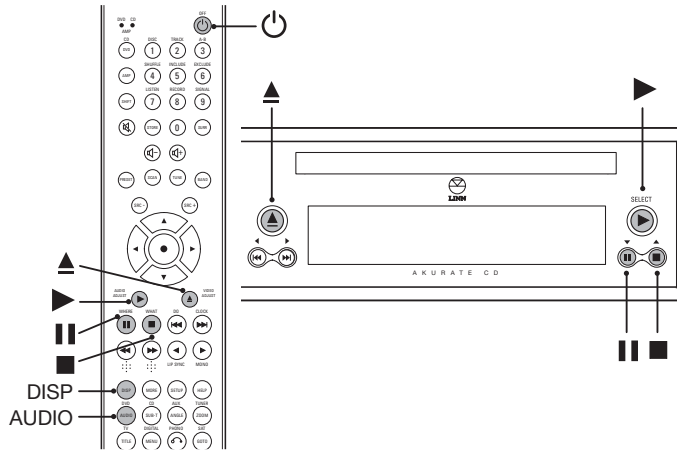



Standby mode

When first powered up, your AKURATE CD will be in standby and the display will show the standby symbol .

To bring the unit out of standby:

- Press  on the handset or any button on the front panel.

To put the unit into standby:

- Press  on the handset or press and hold  on the front panel.



Notes:

Standby mode reduces the power used by the unit and is useful for situations where the unit is not being used for a short time and/or requires to be switched on remotely.

For longer periods of non-use, switching off at the mains is recommended.

Playing discs

To play a disc:

- Press .
- Insert a disc with the playback side facing down.
- Press .
- The disc drawer closes and playback begins automatically.

Notes:

The disc drawer can be closed by nudging it.

Be careful not to scratch your discs as this can affect their performance.

Certain types of disc may take up to 15 seconds before they begin playing.

Do not leave the disc drawer open as this allows dust into the unit.

Press  at any point during playback to replay the current track from the beginning.

To pause a disc:

- Press **II**.
- To resume playback, press **▶**.

To stop playback:

- Press **■**.

To remove a disc:

- Press **▲**.
- Remove the disc then press **▲** or nudge the disc drawer to close.

Display

Key to symbols shown on the front panel display:

▶ Play	⏮ Slow search forwards
II Pause	⏪ Slow search backwards
■ Stop	▶ Fast scan forwards
▶▶ Skip to next track	◀ Fast scan backwards
◀◀ Skip to previous track	↺ Repeat
▶▶ Fast search forwards	••• Sleep Display
◀◀ Fast search backwards	⏻ Standby

Displayed disc information

The front panel display shows information relating to the current disc.

Repeated presses of **DISP** on the handset change the information shown, in the following sequence:

Track elapsed
Track remaining
Group/disc elapsed
Group/disc remaining
Track name (SACDs only)

Additional disc information is displayed on the front panel display to the left and right of the time information:

CD, SACD	
Left of time display	Total number of tracks
Right of time display	Current track number
DVD-Audio	
Left of time display	Current group number
Right of time display	Current track number

Playing SACDs

SACDs can contain up to three separate areas, each of which features a different audio format. The three formats are, in order of audio quality from highest to lowest, SACD Multi (5.1 channels of high quality audio), SACD Stereo (2 channels of high quality audio) and CD Stereo (2 channels of standard CD audio).

When an SACD is inserted into the AKURATE CD, the unit will default to the format that was selected the last time an SACD was played. If that area is not present on the current disc, the unit will select the next best format available. If the unit is set to '2 Channel' (see *Channel Setup* in *User Options* (page 17)), the multi-channel audio format will be downmixed to stereo.

You are able to select which audio format you wish to listen to from those available.

The disc must be stopped in order to change format.

To change format:

- Repeatedly press **AUDIO** on the handset until the desired format is shown on the front panel display.
- Press ►. The ► symbol on the front panel display will flash to show that the AKURATE CD has accepted the command. When the unit has selected the requested format, playback will begin.

Playing DVD-Audios

DVD-Audio discs can contain both stereo (two-channel) and surround sound (multi-channel) formats. The AKURATE CD will automatically begin playback when a DVD-Audio is loaded. The basic controls (play, stop, skip track, etc.) can be used as normal to control playback.

When a DVD-Audio is inserted into the AKURATE CD, the unit will play the multi-channel format by default. If there is no multi-channel format available, it will play the stereo format. If the unit is set to '2 Channel' (see *Channel Setup* in *User Options* (page 17)), the multi-channel audio format will be downmixed to stereo.

DVD-Audio discs normally require a display device (e.g. television) in order to navigate menus. DVD-Audio menus are not accessible on the AKURATE CD as there is no connection to a display device.

Disc navigation controls

This section explains how to locate and select a particular track, and how to search and scan through tracks.

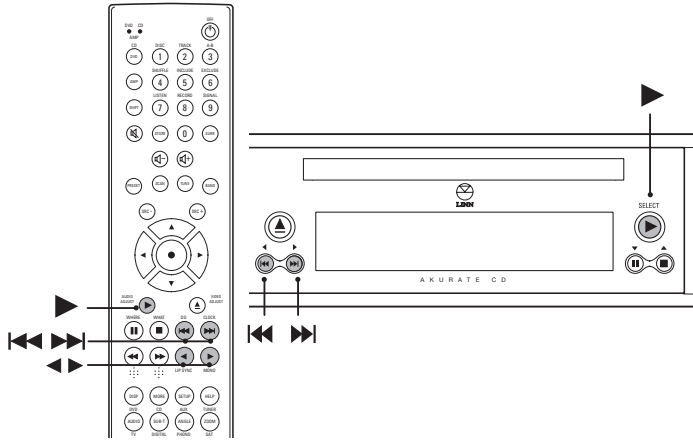

Skip track

To skip forwards or backwards through the tracks on a disc:

- To skip forwards, repeatedly press ►►.
- To skip backwards, repeatedly press ◄◄.

Search

To fast search forwards or fast search backwards while a disc is playing:

- To fast search forwards, hold ►►.
- To fast search backwards, hold ◄◄.

Fast scan

To fast scan forwards or fast scan backwards while a disc is playing:

- To fast scan forwards at 2x normal speed, press ► on the handset.

Further presses of ► increase the speed of forward playback: 4x, 6x, 8x normal speed.

- Press ► (play) to resume normal playback.

- To fast scan backwards at 2x normal speed, press ◄.

Further presses of ◄ increase the speed of reverse playback: 4x, 6x, 8x normal speed.

- Press ► (play) to resume normal playback.

Direct track access

You can use the digit keys on the handset to directly access the track you wish to play.

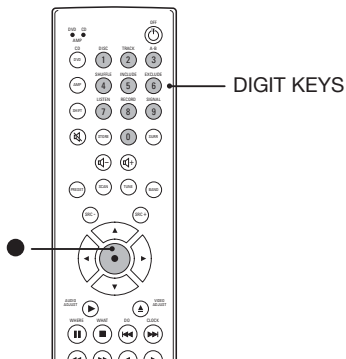

To select a track:

- Press the appropriate digit key or keys on the handset.
- Press ● to confirm your choice or wait a few seconds and the track will automatically be selected.

Note:

Direct track access can be used whether a disc is playing, stopped or ejected (i.e. drawer open with disc in it).

Additional controls

This section explains how to use the additional Repeat, Shuffle and Program functions for advanced control of your music.

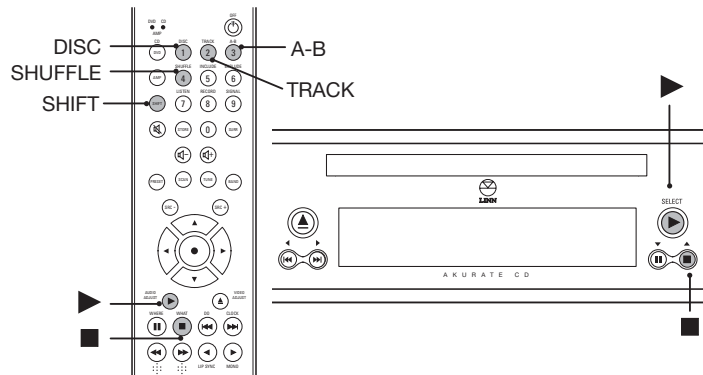

Repeat

The Repeat function allows you to repeat all or part of a disc.

Repeat disc

To repeat an entire disc:

- Begin playing the disc.
- Press **SHIFT** on the handset, then **DISC** ('1' key) within two seconds. The front panel display shows 'ALL'.

When the disc is finished playing it will automatically play repeatedly.

To cancel the Repeat disc function:

- Press **SHIFT** on the handset, then **DISC** ('1' key) within two seconds.
- or
- Eject the disc.

Repeat track**To repeat a single track:**

- Begin playing the track.
- Press **SHIFT** on the handset, then **TRACK** ('2' key) within two seconds. The front panel display shows 'ONE'.

When the disc is finished playing it will automatically play repeatedly.

To cancel the Repeat track function:

- Press **SHIFT** on the handset, then **TRACK** ('2' key) within two seconds.
- or
- Eject the disc.

Repeat A-B**To repeat a specific section of a disc:**

- At the start of the section you wish to repeat, press **SHIFT** on the handset, and then press **A-B** ('3' key) within two seconds. 'A-' appears on the front panel display.
- Continue playback until you reach the end of the section to repeat.
- Press **SHIFT** then **A-B** ('3' key) within two seconds. The front panel display shows 'A-B'.

Once the 'B' point is set, the chosen section automatically plays repeatedly.

To cancel the Repeat section function:

- Press **SHIFT** on the handset, then **A-B** ('3' key) within two seconds.

Shuffle

The Shuffle function plays the tracks of a disc in a random order. The disc must be stopped before this function can be accessed.

To shuffle the order in which tracks are played:

- Press **SHIFT** on the handset, then **SHUFFLE** ('4' key) within two seconds. The front panel display shows 'SHF' (shuffle).
- Press **▶** to start playback.

To cancel Shuffle function:

- Press **■**.
- Press **SHIFT** on the handset, then **SHUFFLE** ('4' key) within two seconds.

Note:

The Shuffle function is not available for DVD-Audios.

Program (Include/Exclude)

The Program function allows you to customise the way a disc is played – either select tracks from a disc and play them in your preferred order (Include) or play the disc as normal but with certain tracks removed (Exclude).

The disc must be stopped before this function can be accessed.

Note:

The Program function is not available for DVD-Audios.

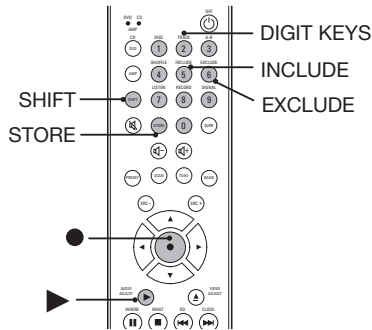

Include Program

This program mode allows you to select which tracks you wish to listen to from those available on a disc.

To select which tracks are to be played:

1. Press **SHIFT** on the handset, then **INCLUDE** ('5' key) within two seconds. The front panel display shows 'Prg: 01:00' and 'INC' (include).
2. Using the digit keys, enter the number of the first track that you wish to include in your playlist.

3. Press **STORE** or ● to store the selection and move to the next program step.
4. Repeat steps 2 and 3 for all tracks you wish to select.
5. Press ► to store the program and start playback of the selected tracks.

To clear a stored program or cancel Include Program mode:

- Press **SHIFT** on the handset, then **INCLUDE** ('5' key) within two seconds.

Exclude Program

This program mode allows you to select which tracks you do not wish to listen to from those available on a disc.

To select which tracks are to be excluded:

1. Press **SHIFT** on the handset, then **EXCLUDE** ('6' key) within two seconds. The front panel display shows 'Prg: 01:00' and 'EXC' (exclude).
2. Using the digit keys, enter the number of the track you wish to exclude.
3. Press **STORE** or ● to store the selection and move to the next program step.
4. Repeat steps 2 and 3 for all tracks you wish to exclude.
5. Press ► to store the program and start playback of the remaining tracks.

To clear a stored program or cancel Include Program mode:

- Press **SHIFT** on the handset, then **INCLUDE** ('6' key) within two seconds.

User Options

This chapter explains how you can configure certain features of the AKURATE CD to suit your own requirements.

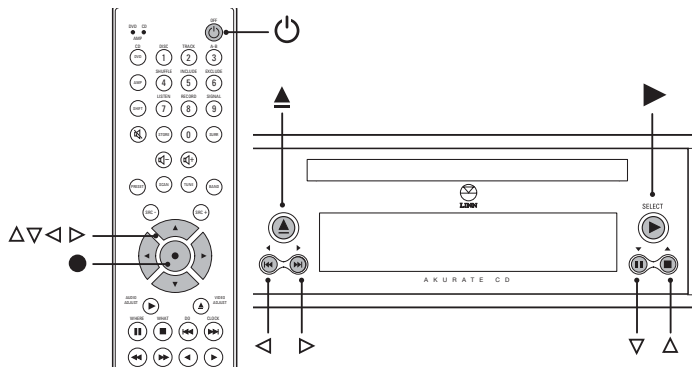

To enter user options:

- Press **⏻** on the handset or press and hold **▶** on the front panel to enter standby.
- Hold **▲** on the front panel until the display shows 'User Options'.

To change a user option:

- Repeatedly press or hold **△** or **▽** on the front panel or handset to select the required user option.
- Repeatedly press or hold **◀** or **▶** to change the setting of the user option.

To restore a user option to its default value:

- Select the required user option.
- Press **●** on the handset.

Default values will be marked with a "*" on the front panel display.

To save settings and exit user options:

- Press **▶** on the front panel or handset.

Table of user options

The following table shows the user options that are available, briefly describes them and shows the available settings for each. Default settings are shown in bold (and are marked with a "*" on the front panel display).

Option	Description	Settings
Display Brightness	Allows adjustment to the brightness of the front panel display. When set to AUTO the unit will select a brightness level based on the ambient light level in the room (the greater the ambient light level, the brighter the display will be).	AUTO 2% to 100% (non-linear)
Sleep Display Delay	Sets the number of seconds that the unit is inactive for before the sleep display (three dots) is shown on the front panel.	OFF 0m 10s to 5m 00s (in 10 sec steps)
Front Panel IR (infrared) Commands	If set to ACCEPTED, unit will respond to commands received via the IR receiver on the front panel.	ACCEPTED IGNORED
Pass IR to Remote Out	If set to ENABLED, passes commands received via the IR receiver on the front panel to REMOTE OUT. Will function even if 'Front Panel IR Commands' is set to IGNORED.	ENABLED DISABLED
Pass Remote In To Out	If set to ENABLED, passes RC5 commands received at REMOTE IN to REMOTE OUT.	ENABLED DISABLED

Option	Description	Settings
SPDIF Out	<p>If you are not using the AKURATE CD's digital audio outputs, set to OFF.</p> <p>If any of the AKURATE CD's digital outputs are connected to a Linn AKURATE KONTROL pre-amplifier, other external audio decoder or other device, set to RAW.</p> <p>If you are recording to an external digital source (e.g. DAT player), set to LtRt PCM.</p>	RAW LtRt PCM OFF
LPCM Output (Digital outputs only)	<p>If any of the AKURATE CD's digital outputs are connected to a Linn AKURATE KONTROL pre-amplifier, or any other device which accepts a sampling rate of 96 kHz, set to LPCM 96 k.</p> <p>If the external device does not accept a sampling rate of 96 kHz, set to LPCM 48 k.</p> <p>Notes: Even when set to LPCM 96 k, some discs will only output at the lower rate of 48 kHz.</p> <p>Audio signals from SACDs and DVD-Audios are output as analogue only. There is no output for these disc types from the digital connectors.</p>	LPCM 96k LPCM 48k

Option	Description	Settings
Channel Setup (Analogue outputs only)	<p>If the AKURATE CD is being used in a two channel (or stereo) system, set to 2 CHANNEL. (In such a system 5.1 channel material on SACDs and DVD-Audios will be downmixed to 2 channels.)</p> <p>If the AKURATE CD is being used in a system that has more than two channels, set to 5.1 CHANNEL.</p>	2 CHANNEL 5.1 CHANNEL
Downmix	<p>If you are going to apply Dolby Pro Logic decoding to the analogue audio signal, set to LtRt.</p> <p>If you are not going to apply Dolby Pro Logic decoding to the audio signal, set to PURE STEREO.</p>	PURE STEREO LtRt
RS232 Baud rate	Sets the baudrate for RS232 control.	9600 4800 to 230400 (8 settings)
RS232 Events	If set to ENABLED, passes information regarding the internal status of the unit to an external device that accepts RS232 data.	ENABLED DISABLED
RS232 Start Message	If set to ENABLED, will output an RS232 start message when the unit is switched on.	ENABLED DISABLED

Option	Description	Settings
DVD commands	<p>If set to ACCEPTED, DVD commands such as Play, Pause, Stop, Skip etc. that are relevant to the AKURATE CD will be accepted from the handset whether the handset is in DVD or CD mode.</p> <p>If set to IGNORED, these commands will only be accepted if the handset is in CD mode.</p> <p>See <i>Handset</i> (page 6) for further detail.</p>	ACCEPTED IGNORED
Scroll SACD text	<p>ONCE: Track information on SACDs will scroll once across the front panel display.</p> <p>LOOP: Track information on SACDs will scroll repeatedly across the front panel display.</p> <p>OFF: Track information on SACDs will not appear on the front panel display.</p>	ONCE LOOP OFF

Technical Specifications

Electrical

Mains input range	AC 100 - 120 V; AC 220 - 240 V
Mains frequency range	50 - 60 Hz
Power consumption	40 W approx

Physical

Weight	4.5 kg / 10 lbs
Dimensions	W 381 mm, D 360 mm, H 80 mm / W 15", D 14 1/8", H 3 1/8"

Signal Interfaces

Analogue audio

Type	Connector	Level	Impedance	Notes
Unbalanced	8 x RCA	2 V rms	300 Ω	Front L(A), L(B), R(A), R(B); Rear L and R; Centre and Sub
Balanced	2 x male XLR	4 V rms	600 Ω	Front L and R (pin1 gnd, pin 2 hot, pin 3 cold)

Digital audio

Type	Connector	Level	Impedance	Notes
SPDIF	BNC	500 mVp-p	75 Ω	Electrical
	TOSLINK	-	-	Optical

Data and Control

Type	Connector	Level	Impedance	Notes
RS232	2 x RJ11	-	-	-
Remote In/Out	2 x RCA	-	-	For KNEKT use only

Guarantee and Service

This product is guaranteed under the conditions which apply in the country of purchase and your statutory rights are not limited. In addition to any statutory rights you may have, Linn undertake to replace any parts which have failed due to faulty manufacture. To help us, please ask your Linn retailer about the Linn warranty scheme in operation in your country.

In parts of Europe, the United States of America and some other markets, extended warranty may be available to customers who register their purchase with Linn. A warranty registration card is included with the product and should be returned to Linn as soon as possible. Alternatively, you can register your warranty online at www.linn.co.uk.

Warning

Unauthorised servicing or dismantling of the product invalidates the manufacturer's warranty. There are no user serviceable parts inside the product and all enquiries relating to product servicing should be referred to authorised retailers only.

Technical support and information

For technical support, product queries and information, please contact either your local retailer or one of the Linn offices opposite.

Full details of your local retailer/distributor can be found on the Linn web site: www.linn.co.uk.

Important

Please keep a copy of the sales receipt to verify the purchase date of the product.

Please ensure that your equipment is insured by you during any transit or shipment for repair.

Linn Products Limited

Glasgow Road
Waterfoot
Eaglesham
Glasgow G76 0EQ
Scotland, UK

Phone: +44 (0)141 307 7777
Fax: +44 (0)141 644 4262
Helpline: 0500 888909
Email: helpline@linn.co.uk
Website: www.linn.co.uk

Linn Incorporated

8787 Perimeter Park Boulevard
Jacksonville
FL 32216 USA

Phone: +1 (904) 645 5242
Fax: +1 (904) 645 7275
Helpline: 888-671-LINN
Email: helpline@linninc.com
Website: www.linninc.com

Linn Deutschland GmbH

Hühnerposten 1d
D-20097 Hamburg
Deutschland

Phone: +49-(0) 40-890 660-0
Fax: +49-(0) 40-890 660-29
Email: info@linngmbh.de
Website: www.linn.co.uk

Free Manuals Download Website

<http://myh66.com>

<http://usermanuals.us>

<http://www.somanuals.com>

<http://www.4manuals.cc>

<http://www.manual-lib.com>

<http://www.404manual.com>

<http://www.luxmanual.com>

<http://aubethermostatmanual.com>

Golf course search by state

<http://golfingnear.com>

Email search by domain

<http://emailbydomain.com>

Auto manuals search

<http://auto.somanuals.com>

TV manuals search

<http://tv.somanuals.com>