



**LT-800-150 Stationary FM Transmitter**

***Don't miss a single sound.***





Dear Valued Customer,

Thank you for choosing Listen! All of us at Listen are dedicated to providing you with the highest quality products available. We take great pride in their outstanding performance because we care that you are completely satisfied. That's why we independently certify them to the highest quality standards and back them with a limited lifetime guarantee. We stand ready to answer any questions you might have during installation or in the operation of our products. Should you experience any problems whatsoever with your Listen products, we are ready to help you in any way we can with prompt, efficient customer care. Because at Listen, it's all about you! And should you have any comments on how we might improve our products or our service, we're here to listen.

Here's how to reach us:

+1.801.233.8992

+1.800.330.0891 North America

+1.801.233.8995 fax

[support@listentech.com](mailto:support@listentech.com)

[www.listentech.com](http://www.listentech.com)

Thank you and enjoy your listening experience!

Best regards,

Russell Gentner and the Listen Team

- In the few instances where repairs were needed, 99% of all clients indicated that they were happy with repair turn-around-times and 85% of the time, clients were without their product for less than 10 days!
- Overall client satisfaction of working with Listen was rated 4.8 out of 5.
- "Please continue with your excellent attitude toward customer satisfaction. You guys are great!"
- "I've never had such good service from any company. Keep up the good work!"
- "You stand behind your product wonderfully."



# *LT-800 Table of Contents*

---

Package Contents	3
150 MHz Specifications	4
Block Diagram	5
Quick Reference	6
Setup Instructions	7
Operating Instructions	10
Audio Control	11
Listen SQ™ (Super Quiet)	12
RF Reception Maximization Strategies	13
Coaxial Cable	13
Channel Selection	14
150 MHz Frequency Chart	15
Troubleshooting	16
Warranty	18
Contacting Listen	18
Optional Accessories	19



# LT-800 Package Contents

---

## LT-800 Contents

- LT-800-150 (150 MHz)
- 12 VDC Power Supply
- User Manual
- Quick Reference Card



## Listen Part Number

LT-800-150 (150 MHz)

## Optional Accessories

See pages 19-20

# LT-800 Specifications

## Architectural Specifications

The stationary FM transmitter shall be capable of broadcasting on 32 channels. The transmitter shall have an SNR of 80 dB or greater. The output power shall be adjustable to quarter, half or full. Channel tuning shall be capable of being locked. The device shall have an audio frequency response of 50 Hz to 15 kHz ( $\pm 3$  dB). It shall have two (2) mixing audio inputs and a mixed signal output. The device shall have the following audio controls: input level, mix level and an adjustable low pass filter (contour). The device shall have an audio processor that is capable of automatic gain control and limiting. The Listen LT-800-150 is specified.

### Specifications\*

Audio	RF Frequency Range	150.8000 MHz - 152.3500 MHz
	Number of Channels	6 wideband, 26 narrowband
	Number of Simultaneous Transmitters	6
	Frequency Accuracy	$\pm .005\%$ stability 32 to 122° (0 to 50°C)
	Transmitter Stability	50 PPM
	Transmission Range	Up to 762 m (2500 ft.)
	Output Power	100 mW
	System Frequency Response	50 Hz - 15 kHz ( $\pm 3$ dB)
	System Signal to Noise Ratio	SQ enabled 80 dB, SQ disabled 60 dB
	System Distortion	<2% total harmonic distortion (THD) at 80% deviation
	Audio Input 1	Rear panel, one (1) Female XLR and 1/4 in combo connector, balanced, 0 / -55 dBu (line/mic) nominal input level adjustable, -30 / +21 dBu (line/mic) maximum input level, impedance 20k / 1k ohms (line/mic), phantom power +12 VDC
	Audio Input 2	Rear panel, two (2) phono connectors, unbalanced, -10 / +10 dBu nominal input level adjustable, +30 dBu maximum, impedance 100k ohms
	Audio Processing (Process)	Compression can be turned on/off. Slope internally adjustable from 1:1 to 4:1. Default 2:1
	Contour	Cuts and boosts frequencies above 5 kHz
	Combined Audio Output (Mix)	Input 1 and input 2, mixed output (rear panel), two (2) phono connectors, unbalanced, -10 dBu nominal output level, +15 dBu maximum, impedance 10 ohms
Headphone Output (Monitor)	Front panel, one (1) 3.5 mm (0.14 in.) stereo connector, unbalanced, adjustable output level, +3 dBu maximum, impedance 10 ohms	

Controls & Indicators	Front Panel	Power, Test Tone on/off, Channel up/down, Input Levels, Mix Level, Contour, Monitor volume control
	Rear Panel	"Input 1 Level, (Line, Mic, Mic-Phantom Power), Input 2 level (-10 / +10 dBu), RF power level (low, mid, high)"
	Programming	Process on/off, SQ on/off, channel lock
	Input1, Input 2, Mix Level VU	Indicates Input 1, Input 2, and Mix audio levels; 10 segment LED's (8 green, 2 red)
	Processing	Indicated by a green LED when on (front panel)
	RF Power	Indicated on the LCD (low, mid, high)
	LCD Display	Channel Designation, lock status, RF power level, programming (front panel)
Test Tone	Red LED illuminates when test tone is enabled.	

Power	Power Supply	In line power supply (Listen part number LA-207)
	Power Supply Input	Input: 100-240 VAC, 50-60 Hz, 0.4 A
	Power Supply Output	Output: 12 VDC, 1.3 A, 15.6 W
	Power Supply Connector	Output Connector: 0.02 in (5.0 mm) OD, 0.01 in. (2.5 mm) ID, barrel type
	Power Supply Compliance	UL, CE, GS, TÜV, RoHS

Physical	Dimensions (H x W x D)	1.75 x 8.50 x 9.13 in (4.5 x 21.5 x 23 cm)
	Color	Dark Grey with white silk screening
	Unit Weight	2.6 lbs. (1.2 kg)
	Shipping Weight	6 lbs. (2.7 kg)

Environmental	Temperature - Operation	-10 °C (14 °F) to +40 °C (104 °F)
	Temperature - Storage	-20 °C (-4 °F) to +50 °C (122 °F)
	Humidity	0 to 95% relative humidity, non condensing

\*Specifications are subject to change without notification



# LT-800 Block Diagram

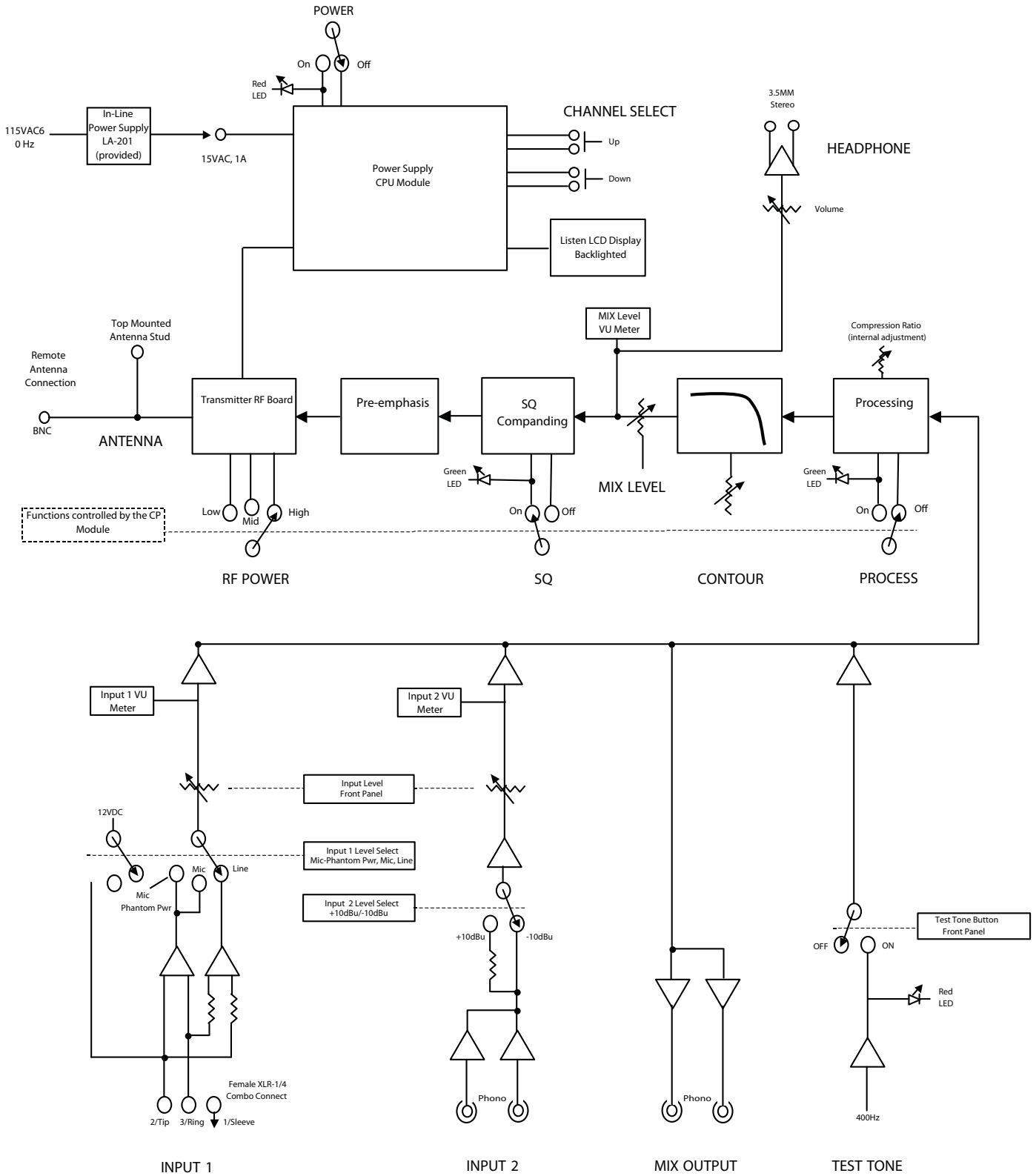

# LT-800 Quick Reference

## LT-800 Front Panel: Controls & Displays

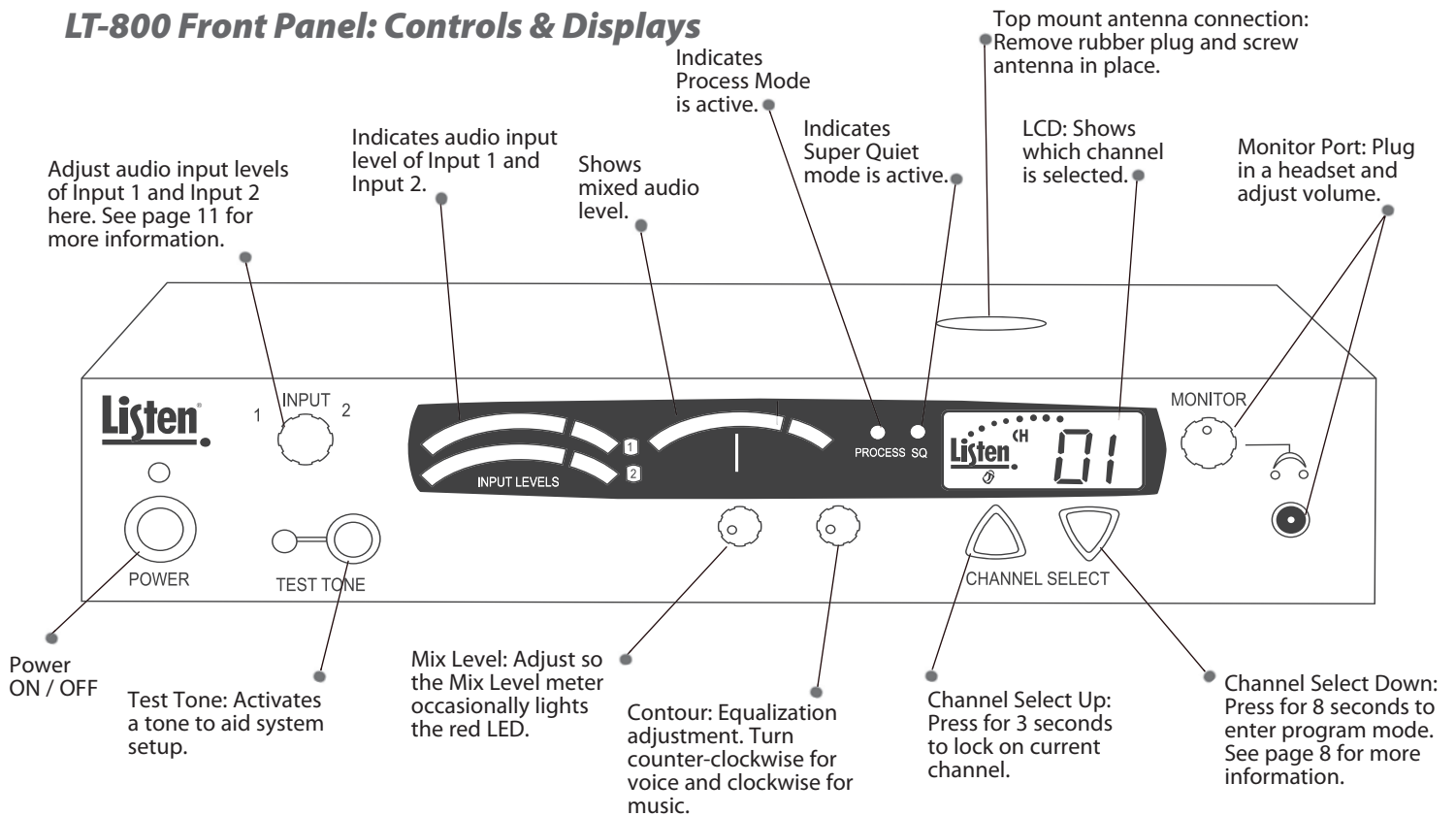

## LT-800 Back Panel: Connections & Settings

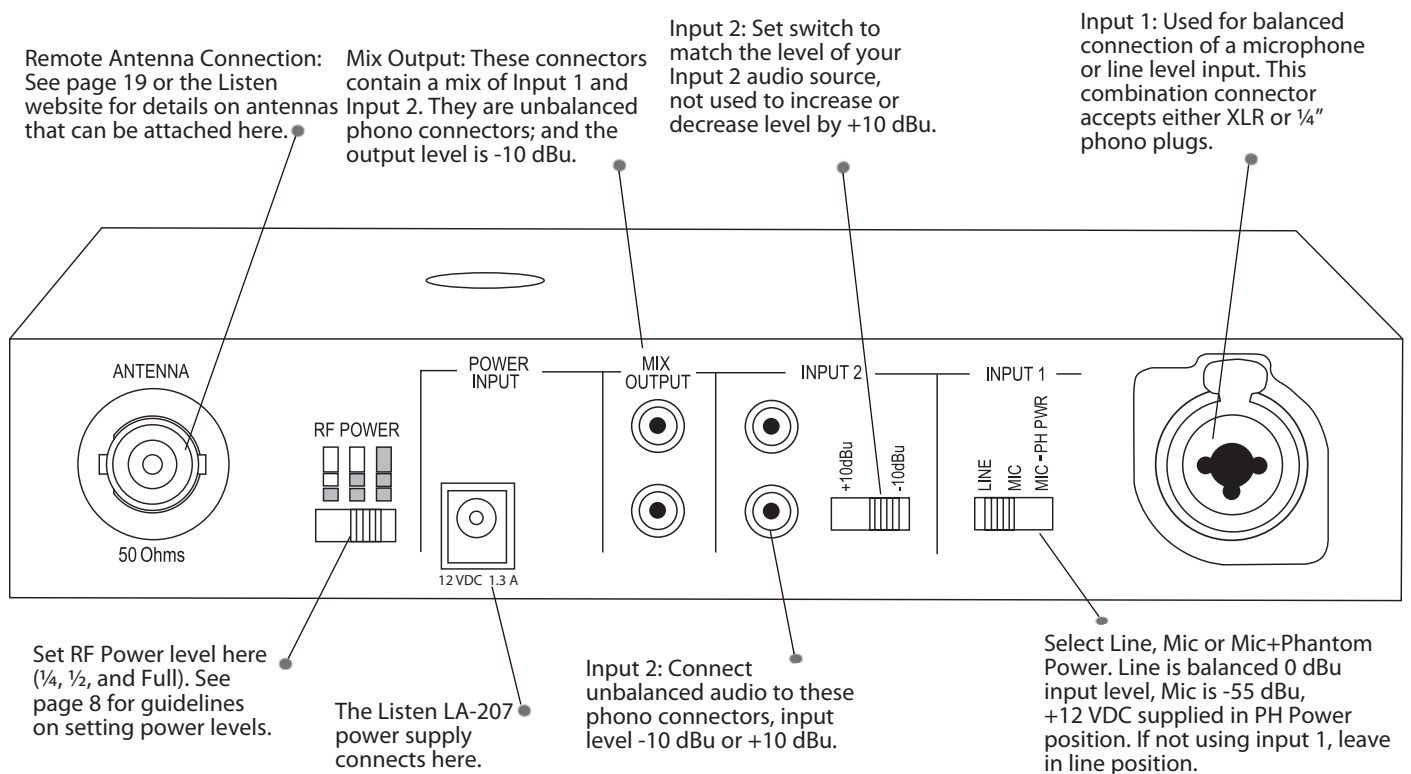

# LT-800 Setup Instructions

## 1 **Unpack the Product**

Remove outer packaging and plastic cover. Inspect for physical damage.

## 2 **Mount in Rack (if necessary)**

If rack mounting the unit, install the optional rack mount kit (part LA-326) according to the instructions included with the kit, then install the LT-800 in the rack.

**NOTE: If rack mounting, you will need to use a rear connection antenna.**

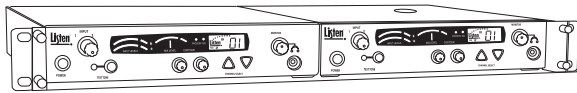

Rack Mount with dual unit installed

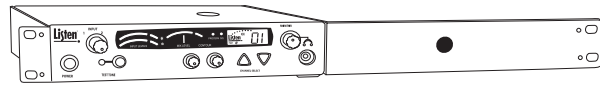

Rack Mount with single unit installed  
Shown with LT-800

## 3 **Connect Antenna**

Connect the antenna (not included) according to the installation instructions. Only use an antenna supplied by Listen. If you are connecting the antenna directly to the top of the LT-800, you will need to remove the rubber plug on top of the unit. If you are using a remote antenna connected to the rear of the unit, do not connect an antenna to the top connector. See page 19 for antenna options, or refer to the Listen website for remote antenna options, [www.listentech.com](http://www.listentech.com).

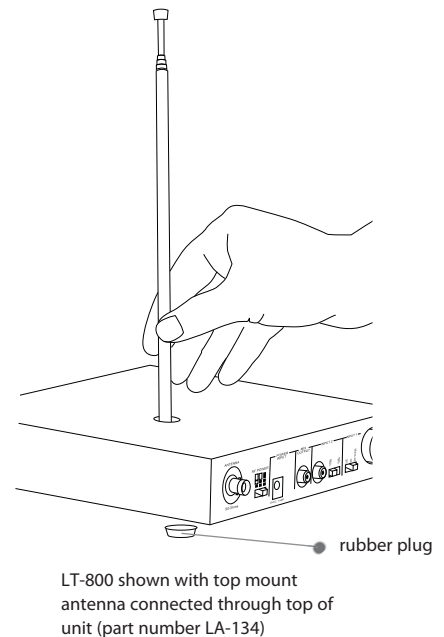
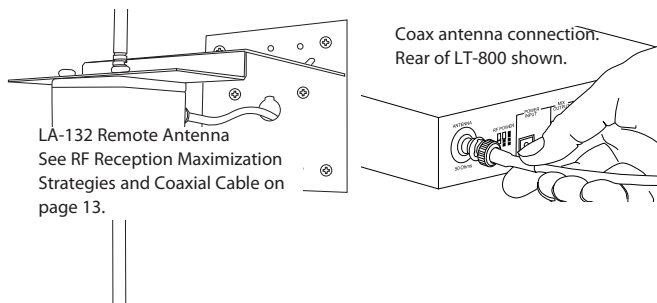

## 4 **Connect Power**

Plug the power supply into the power connector on the back panel, then plug the power supply into an outlet. Only use a Listen approved power supply (The LA-207, an in-line switching power supply, is the approved power supply for this unit).

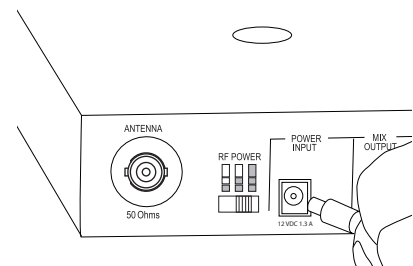

5

## Set SQ™ (Super Quiet) and Process Features

Your transmitter is shipped to you with SQ (super quiet) enabled and Process disabled. For a detailed description of these features and when to use them, please refer to page 12.

### To Disable or Enable SQ and Process Features:

With the unit on press and hold the channel select "Down" button for 8 seconds. The program (PGM) icon will appear on the LCD.

Once in the program mode,



the SQ and Process features can be turned on and off by pressing the channel select buttons. Press the channel select "Up" button to toggle between Process On and Off. Press the channel select "Down" button to toggle between SQ On and Off.

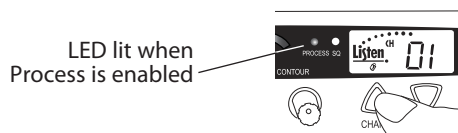

If the green LED is illuminated on the front panel, that feature is enabled. Once you have enabled or disabled the features as desired, let the transmitter exit the program mode by waiting 5 seconds.

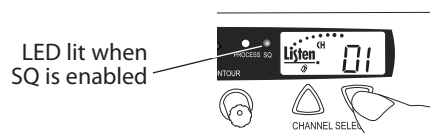

6

## Set RF Power

Set the RF POWER switch on the back of the unit to 1/4, 1/2, Full (Level is indicated on the LCD display). The amount of transmitted RF power that you will need depends on your application. If you are operating multiple transmitters in the same environment, it is best to set the transmitters output power to its lowest level to reduce the possibility of interference.

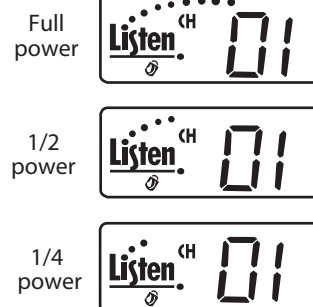
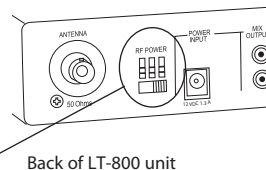

## 7 Connect Audio Inputs

The LT-800 has two audio input options: Input 1 and Input 2. Input 1 is a balanced connection using either an XLR or 1/4" phono connector. Input 2 has two unbalanced mixing phono connectors. Use Input 1 if you are using a microphone or if you have a balanced connection such as from a professional audio mixer (you can also use Input 1 for unbalanced connections). Use Input 2 to connect to an unbalanced audio source.

### Input 1

Input 1 offers a choice of balanced XLR or 1/4" phono connector.

Plug your microphone into Input 1 and move the input select switch to Mic (for dynamic microphones) or Mic + PH Power (for condenser microphones).

Plug your balanced or unbalanced audio source into Input 1. Use the following diagram.

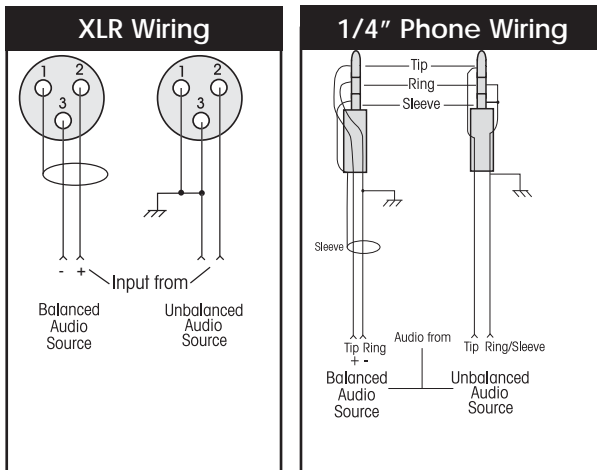
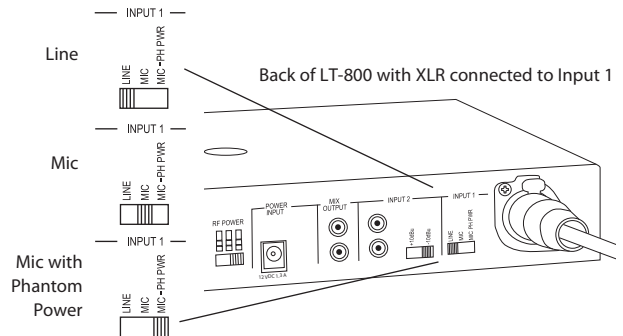

### Input 2

Plug your unbalanced audio source into Input 2 and select the audio level switch for -10 dBu or +10 dBu, to match the audio level coming from your equipment.

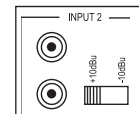

# LT-800 Operating Instructions

## 1 Power Unit On

Turn power on by pressing the power button.

## 2 Select a Channel

Select the transmit channel by pressing the channel select UP and DOWN buttons. See Channel Selection on page 14 for more information.

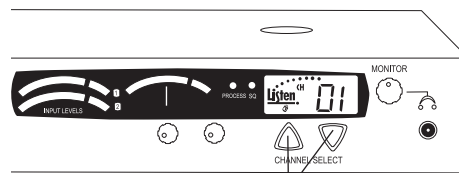

Channel Select UP and DOWN buttons

## 3 Lock on Channel

Once you determine your transmit channel, you can lock the transmitter on that channel. To lock on a channel hold the Channel Select "Up" button for 3 seconds until the padlock icon appears on the display. To unlock, repeat this process and the padlock icon will disappear.



## 4 Test Tone (if necessary)

To broadcast a test tone, press the test tone button. This helps to test receivers when no audio source is available.

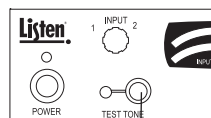

Press Test Tone button here

## 1 **Adjust Audio Input Level**

Adjust the input knob counterclockwise to add gain to Input 1. This will decrease gain to Input 2. Adjust input knob clockwise to add gain to Input 2. This will decrease gain to Input 1. If you have two audio sources connected to both Input 1 and 2, adjust the level of one input using the VU meter, then adjust the output level of the other audio source. Adjust the input level until the left VU meter(s) occasionally illuminate the red LEDs. Illumination of the red LEDs indicates the unit is in limiting. Limiting is required so that the unit does not over-modulate the transmitter. If you don't want any audio limiting to occur, make sure the red LEDs never illuminate. If you want a highly limited signal, turn the audio gain up so the red LEDs illuminate often.

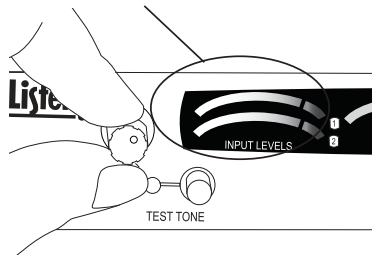

## 2 **Adjust Mix Level**

Adjust the mix level until the right VU meter occasionally illuminates the red LED. This is the level adjustment for the combined output from Input 1 and Input 2.

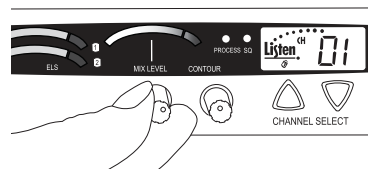

## 3 **Adjust Contour**

Adjust the Contour knob counterclockwise if your audio source is mostly voice. Adjust the knob clockwise if your audio source is mostly music. The Contour knob adjusts the relative equalization of the unit. This equalization boosts or cuts frequencies above 5 kHz.

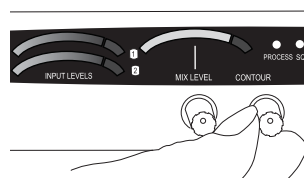

People are accustomed to listening to low noise, high fidelity audio (delivered via CD, DVD, etc.). FM radio systems, such as those made by Listen, have more inherent noise compared to most sound systems. To minimize noise, Listen uses a noise reduction technology called ListenSQ™. Both the transmitter and receiver must have the SQ feature enabled to achieve the desired results. SQ is available on new Listen systems, including the system you received in this shipment. If you are planning to use this product with older Listen systems that do not have Listen SQ, or equipment not manufactured by Listen, you must disable Listen SQ.

Your Listen LT-800 has been shipped to you with the SQ feature enabled. You may need to disable the SQ function for one or more of the following reasons:

- 1 You are using your new Listen LT-800 with older version Listen receivers that do not have the SQ function.
- 2 You are using your new Listen LT-800 with equipment supplied by other manufacturers (Listen is the only manufacturer using SQ Technology).
- 3 You expect that end users will bring and use their own receivers that don't have the SQ function.

**NOTE:** See page 8 to enable or disable SQ (Super Quiet).

## **Process Mode**

Process mode is used for Audio Gain Control (AGC). With the process mode enabled, the LT-800 will automatically adjust for inconsistent signal input levels by raising or lowering the signal level accordingly to provide a consistent sound output level. This feature should be used in applications where a consistent sound level is important and the input levels vary substantially. Typically you would not want to engage the Process Mode when a speaker's emphasis is critical to the message they are conveying.

## **SQ Summary**

- SQ is NOT squelch
- SQ improves noise performance by at least 20 dB
- SQ is NOT compatible with older version Listen products
- SQ is NOT compatible with other manufacturers' products
- To work properly, SQ must be enabled for both the transmitter and receivers
- SQ can be disabled to permit operation with older Listen products or other manufacturers' products



# RF Reception Maximization Strategies

---

For proper and dependable operation, Listen receivers need to receive a strong and consistent signal from the originating transmitter. Note that on portable receivers the headset wire is the receiving antenna. The following strategies should be used maximize to this signal:

- 1 When designing and installing your system, keep in mind that the location of both the transmitting and receiving antennas is critical to maximize broadcast range.
- 2 Eliminate or minimize obstructions between the transmitting and receiving antenna.
- 3 Minimize the distance between the transmitting and receiving antennas.
- 4 Move transmitting and receiving antennas away from metal or conductive objects.
- 5 Place the transmitting antenna as high as possible.
- 6 Orient both transmitting and receiving antennas vertically.
- 7 Position the RF Power switch on the back of the LT-800 to full RF Power, unless lower power is acceptable (see page 8).
- 8 Keep coaxial cable from transmitter to antenna as short as possible.

**CAUTION:** *When installing antennas, ensure the antenna is clear of power lines.*

Coaxial cable, connectors, and optional antenna mounting kits are available from Listen. See page 19-20, visit [www.listentech.com](http://www.listentech.com) or ask your dealer for details.

## Coaxial Cable

The antenna for the LT-800 can be mounted directly on the unit if desired. However, you may find that the unit will provide better performance when the antenna is located elsewhere. If you plan to mount the antenna in a different location other than the top of the unit, you must use cable and connectors rated at 50 ohms. Although cable used for cable TV installations looks similar to this cable, it will not work with your Listen system.

If you need to run cable over a length greater than 75 feet for 150 MHz applications or to maximize broadcast range, Listen recommends that you use RG-8 cable rather than RG-58. RG-8 is a lower loss cable, meaning that more of your signal will reach the antenna.

Long cable runs can result in signal degradation due to the "loss" characteristics of the cable. When using RG-58 with a 150 MHz transmitter, there is an average\* loss of 6 dB per 100 feet of cable (A 3 dB loss means half of your power has been lost.) However, it is better to suffer coaxial power loss than to try to shoot your signal through obstacles! Obstacles, especially metal, can create drop-outs or reflections of your signal that will result in poor listening conditions.

**\*NOTE:** *There are many varieties of 50 ohm, RG-58 and RG-8 cables. You may purchase a cable that is better or worse than this value. Please check with the cable vendor or manufacturer for exact specifications.*

It is important to choose channels that are free from interference to achieve proper operation of your Listen equipment. This process is trial and error. Before turning on the transmitter, listen to the wide band channels on the receivers (channels 1-6). Listen to the audio through the headphone or via the speaker and choose a channel with the least amount of interference. Unless you are interfacing with an existing narrowband transmission system, always use a wide band channel.

**If you are using multiple channels follow this process:**

1. **Same Space:** If you are using multiple transmitters in the same space, the most number of channels that will work simultaneously is six at 150 MHz. With all of the transmitters off, listen for interference on all the wide band channels via the headphone jack on a Listen receiver. Using the frequency chart on page 15, eliminate any channels that have noticeable interference. Now choose the channels with the widest channel spacing. It is recommended that adjacent channels be spaced at least 300kHz.
2. **Distributed Spacing:** If you are using transmitters that are spread out over space, you can achieve more simultaneous broadcast channels. However, it is critical that your receiver(s) be located as close to its transmitter as possible. You can use adjacent channels (see frequency chart on page 15) in this case as long as the adjacent channel transmitter is at least 50% further away from the receiver as its transmitter.

It is highly recommended that after channel selection has been achieved, you lock the channel so that it cannot be changed by the user. To accomplish LOCK on the LT-800, press the "UP" button for 3 seconds. Repeat the process to unlock.

**Wide Band Recommendation**

Listen recommends that you always use a wide band channel unless you need to be compatible with existing narrow band receivers from other manufacturers. Wide band channels have lower noise than their narrow band counterparts.

**150 MHz**

The LT-800-150 MHz operates on 6 wide band channels and 26 narrow band channels.

- 1 - 6 = Wide Band Channels
- 7 - 32 = Narrow Band Channels

# 150 MHz Frequency Chart

---

Channel	Frequency
01	150.900
02	152.400
03	151.500
04	152.100
05	151.200
06	151.800
07	150.850
08	150.950
09	151.000
10	151.050
11	151.100
12	151.150
13	151.250
14	151.300
15	151.350
16	151.400
17	151.450
18	151.550
19	151.600
20	151.650
21	151.700
22	151.750
23	151.850
24	151.900
25	151.950
26	152.000
27	152.050
28	152.150
29	152.200
30	152.250
31	152.300
32	152.350

## Troubleshooting

### ***The LT-800 has no power***

Make sure the LA-207 power supply is connected to a power source and is connected to the jack marked "Power Input". Make sure the POWER button is pressed in.

### ***There is no audio or the audio level is too low***

Make sure that your audio source is properly connected to Input 1 and/or Input 2. The Input 1 or Input 2 switches must be in the correct position for the appropriate input level. For example: if you are using the output of a mixer on Input 2, the switch should be in the -10 dBu position. If it were to be in the +10 dBu position, the level would be too low. Also, check the Input knob to ensure it is properly adjusted. You should be able to see the VU meter deflect on Input 1 or Input 2 corresponding with the input level of the audio source. You can listen to the audio source by connecting a headset to the front panel jack and adjusting the Monitor volume control.

If the level of audio into the transmitter is low and can't be corrected using the level input switches, the audio processor can be turned on to boost the signal (see page 8 to set, page 12 for description of Process Mode).

### ***The audio is distorted***

Check to make sure you have the input level select switches in the proper position. You may be providing too much audio level for the input stage to handle. Make sure the SQ mode is set correctly on both the LT-800 and the receivers you are using. If your receivers do not have SQ, make sure the SQ mode is turned off (see page 8).

### ***There is hum in the audio***

Make sure you have properly grounded the audio source to the LT-800. Check the connections from the audio source to the LT-800. If you can, try to use a balanced audio source - this will reduce the chance of creating hum. Connect a ground wire from the LT-800 to ground and/or to the ground of the source audio.

### ***There is a tone***

The Test Tone button has been pressed (its LED light is on). Push the Test Tone button to turn off the tone.

### ***The Audio Input 1 sounds "tinny"***

If you are using an unbalanced audio source, make sure Pin 3 on the XLR or the ring on the ¼" plug is grounded (see page 9).

### ***I cannot pick up the signal on the receiver***

Check to make sure that they are on the same channel. Make sure the LT-800 has an antenna connected. Ensure that the receiver has an antenna (for portable products the headset is the receiving antenna).

### ***I can pick up the signal on the receiver, but it sounds like it's not tuned in***

Check to make sure the transmitter and receiver are on exactly the same channel. It's a good idea to lock the channels once they have been set. To lock the LT-800, press the UP button for 3 seconds (see page 10).

## Troubleshooting

### ***There is not sufficient range***

First make sure that the receivers you are using are operating properly, then make sure that you have an antenna connected either to the top of the LT-800 transmitter or connected to the back of the unit (but not both!). The antenna should be as high as possible and free of obstacles. In addition make sure you are using the correct antenna type for your unit. You might want to use a remote antenna (provided by Listen) that can be mounted on a mast or wall. Try using different frequencies to find one with less interference.

### ***There is interference in my transmission***

Ensure that the transmitter and receivers are on the same channel. Verify that there are no other transmitters on the same channel or a close channel to the one exhibiting interference. Try different channels until you find a clear channel.

### ***End users are adjusting the unit***

First, lock the channel by pressing and holding the channel select UP button for 3 seconds. Consider removing the Input, Mix Level and Contour knobs. You can order a rack mount kit from Listen which offers a security cover that will limit access to the unit.

### ***Several transmitters are operating in the same environment***

For this, you'll need to choose your transmitting frequencies carefully. See page 13-15 for more details.

### ***Can I have two antennas connected to my transmitter***

No. The LT-800 transmitter can use only one antenna connection at a time. You may connect either a top mount antenna through the top antenna port, or a remote antenna connected to the BNC connection on the rear of the unit. If multiple antennae are simultaneously connected to both ports the transmitter will have extremely poor broadcast performance and range.

# Warranty & Contacting Listen

## Warranty

Listen Technologies Corporation (Listen) warrants its transmitters and receivers (LT-82, LT-700, LT-800, LR-42, LR-44, LR-400, LR-500) to be free from defects in workmanship and material under normal use and conditions for the useful lifetime of the product from date of purchase.

Listen warrants its Stationary IR Radiators (LA-140) to be free from defects in workmanship and material under normal use and conditions for three years from the date of purchase.

Listen warrants its Noise Canceling Microphone (LA-270) to be free from defects in workmanship and material under normal use and conditions for one year from date of purchase.

Listen warrants its Charging/Carrying Cases (LA-306, LA-311, LA-313, LA-317, LA-318, LA-319, LA-320, LA-321, LA-322, LA-323, LA-324, LA-325) to be free from defects in workmanship and material under normal use and conditions for one year from date of purchase.

All other products and accessories are warranted for 90 days from date of purchase.

This warranty is only available to the original end purchaser of the product and cannot be transferred. Warranty is only valid if warranty card has been returned within 90 days of purchase. This warranty is void if damage occurred because of misuse or if the product has been repaired or modified by anyone other than a factory authorized service technician. Warranty does not cover normal wear and tear on the product or any other physical damage unless the damage was the result of a manufacturing defect. Listen is not liable for consequential damages due to any failure of equipment to perform as intended. Listen shall bear no responsibility or obligation with respect to the manner of use of any equipment sold by it. Listen specifically disclaims and negates any warranty of merchantability or fitness of use of such equipment including, without limitation, any warranty that the use of such equipment for any purpose will comply with applicable laws and regulations. The terms of the warranty are governed by the laws of the state of Utah.

In the first ninety days after purchase, any defective product will be replaced with a new unit. After 90 days, Listen will, at its own discretion either repair or replace transmitters and receivers with a new unit or a unit of similar type and condition. Product that is not covered under warranty shall be repaired or replaced with a unit of similar type and condition based on a flat fee. Contact Listen for details.

This limited warranty, prices and the specifications of products are subject to change without notice.

## Contacting Listen

If technical service is needed, please contact Listen. Pre-authorization is required before returning Listen products. If products were damaged in shipment, please contact the carrier, then contact Listen for replacement or repair requirements payable by the carrier.

Listen's corporate headquarters are located in Bluffdale, Utah U.S.A. and are open Monday through Friday, 8am to 5pm Mountain Time.

14912 Heritagecrest Way  
Bluffdale, Utah 84065-4818  
+1.801.233.8992  
+1.800.330.0891 North America  
+1.801.233.8995 fax

support@listentech.com  
www.listentech.com

## Antenna Accessories



LA-132  
Universal Antenna Kit



LA-133  
90° Helical Antenna  
(150 MHz)



LA-134  
Telescoping Top Mounted  
Antenna (150 MHz)

## LT-800 Rack Mount Accessories



LA-135  
Antenna Kit for Rack Mount



LA-326  
Universal Rack Mounting Kit  
Includes components for single and dual rack  
configuration and a security cover

**NOTE: Rack mounted units cannot use the  
LA-134 top mounted antenna.**

## Optional Accessories (cont.)

### Cable & Connectors Accessories



LA-112  
RG-58 50 Ohm  
Coaxial Cable (per ft.)



LA-113  
RG-8 50 Ohm Low-Loss  
Coaxial Cable (per ft.)



LA-127  
RG-58 BNC Connector



LA-128  
RG-8 BNC Connector

### Microphone Accessories



LA-261  
Lavalier Microphone



LA-262  
Over-the-Head  
Microphone



LA-270  
Noise Cancelling  
Microphone



LA-274  
Hand-Held  
Microphone



LA-276  
Collar  
Microphone



LA-277  
Conferencing  
Microphone



LA-278  
Behind-the-Head  
Microphone



LA-279  
Over-the-Ear Microphone  
Presentation Style



LA-280  
¼ in. to 3.5 mm  
Microphone  
Adapter for  
LT-800/LT-82

*NOTE: To use Listen microphones you must use a converter (LA-280) to adapt the 3.5 mm connection to a 1/4" phono connection.*



# Notes

---







Listen Technologies Corporation  
14912 Heritagecrest Way  
Bluffdale, Utah 84065-4818, U.S.A.  
+1.801.233.8992  
1.800.330.0891 North America  
+1.801.233.8995 fax

[www.listentech.com](http://www.listentech.com)

Printed in China

© 2009 Listen Technologies Corporation® All Rights Reserved 09162009

## Free Manuals Download Website

<http://myh66.com>

<http://usermanuals.us>

<http://www.somanuals.com>

<http://www.4manuals.cc>

<http://www.manual-lib.com>

<http://www.404manual.com>

<http://www.luxmanual.com>

<http://aubethermostatmanual.com>

Golf course search by state

<http://golfingnear.com>

Email search by domain

<http://emailbydomain.com>

Auto manuals search

<http://auto.somanuals.com>

TV manuals search

<http://tv.somanuals.com>