



Operating instructions

TV

- Individual 32 Selection
- Individual 32
- Individual 26 Selection
- Individual 26

LOEWE.



Contents

Remote control - TV functions	3	Operating modes – PIP	23
Control units	4	PIP picture as freeze picture	23
Connections to rear panel	5	Selecting the station of the PIP picture	23
Welcome	6	Select the station of the TV picture (main picture)	23
Integrated features	6	PIP scan in the PIP picture	23
Scope of delivery	6	Interchanging PIP picture/TV picture	23
Transporting	6	Functions in the PIP menu	24
Installation options	6	Setting the PIP type	24
Note on the LCD screen	7	Position of the PIP picture	24
Cleaning	7	Operating modes – EPG	25
Disposal	7	Using the EPG	25
For your safety	8	EPG menu	26
First installation	9	Selecting providers and stations	26
Remote control	9	Data capture	26
Connection	9	Operating modes – Teletext	27
Handling the fabric hose	10	Page selection with the coloured keys	27
Use of the binders	10	Displaying teletext pages	27
Using the common interface module	10	Programme timer recordings	28
Switching on	10	Teletext menu	28
Automatic programming	11	Digital teletext operation (only for UK device version 27)	28
Directing DVB-T antenna	12	Operating modes – Radio	29
Daily operation	12	Radio menu	29
Switching on/off	12	EPG - Programme guide	29
Changing stations	13	Operating additional equipment	30
Basics about the menu operation	14	Login and connect equipment	30
For the info system ...	15	Video playback	31
For the index ...	16	Timer recording with video or DVD recorder	31
Setting the sound	17	Assignment of digital audio inputs and outputs	32
Picture settings	17	Connecting Loewe DVD Preceiver Auro 2216 PS and Tremo	33
Direct control on TV set	17	loudspeaker system	33
Operating modes – TV	18	Connecting other audio amplifiers or active speakers	34
How the coloured keys work in TV mode	18	HDMI (DVI) connection	35
Show status display	18	VGA/XGA connection	35
Calling the index	18	Component video connection	36
Call additional functions	19	Operating other Loewe devices with the RC3 remote control	37
Call timer overview	19	Setting the remote control to operate devices from other manufacturers	37
Select picture format	19	Rotating the TV set	39
Move picture up/down	19	What to do, if ...	40
TV menu	19	Technical data	42
DVB subtitles	20	General data	42
Removing the CI module	21	Electrical data	43
Inserting a new CI module	21	Accessories	44
Installing new DVB software	21	Service Addresses	45
Image+ menu	22	Codelist RC3 / Lista de códigos RC3	46
Image+ demo mode	22		

Remote control - TV functions

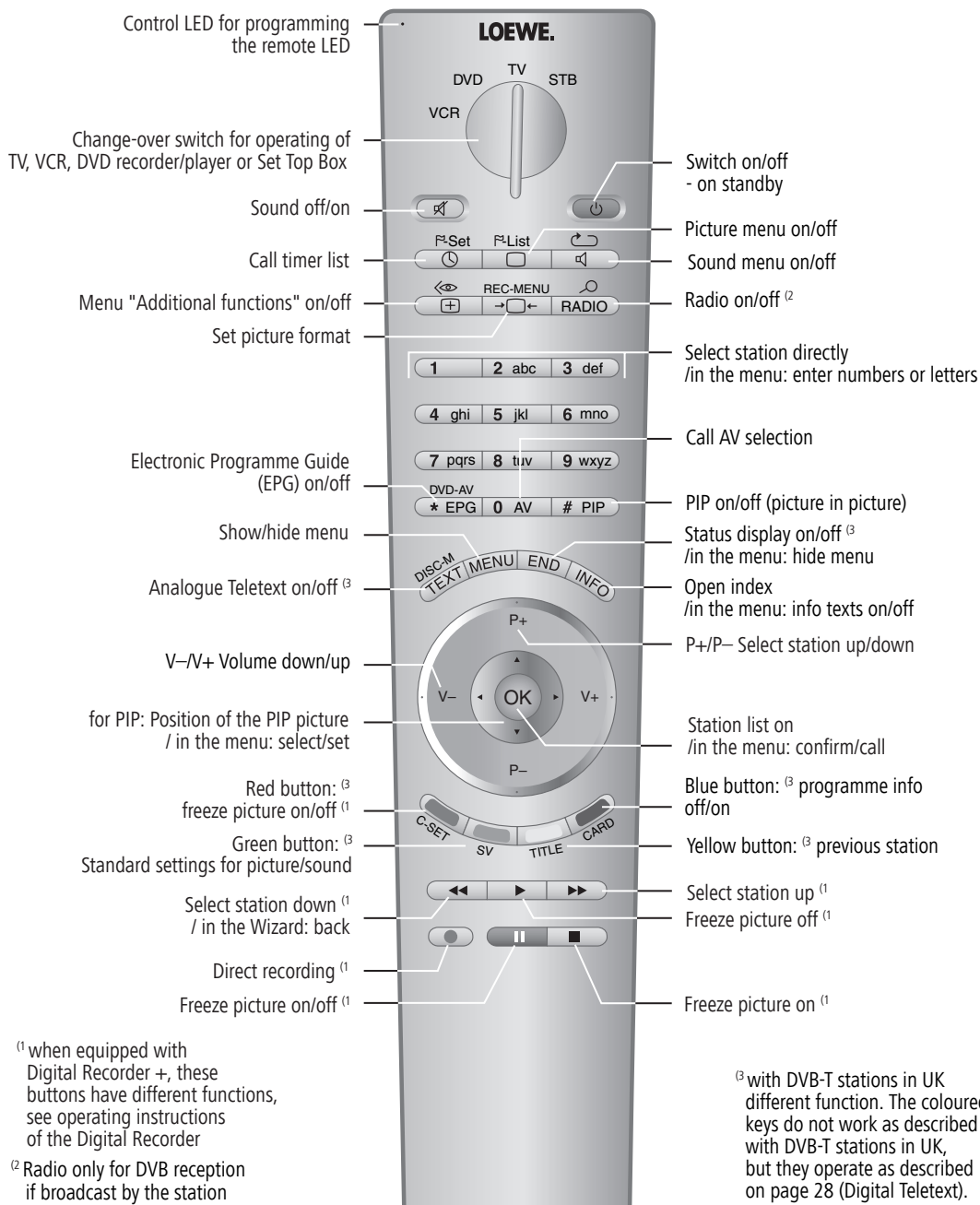

Control units

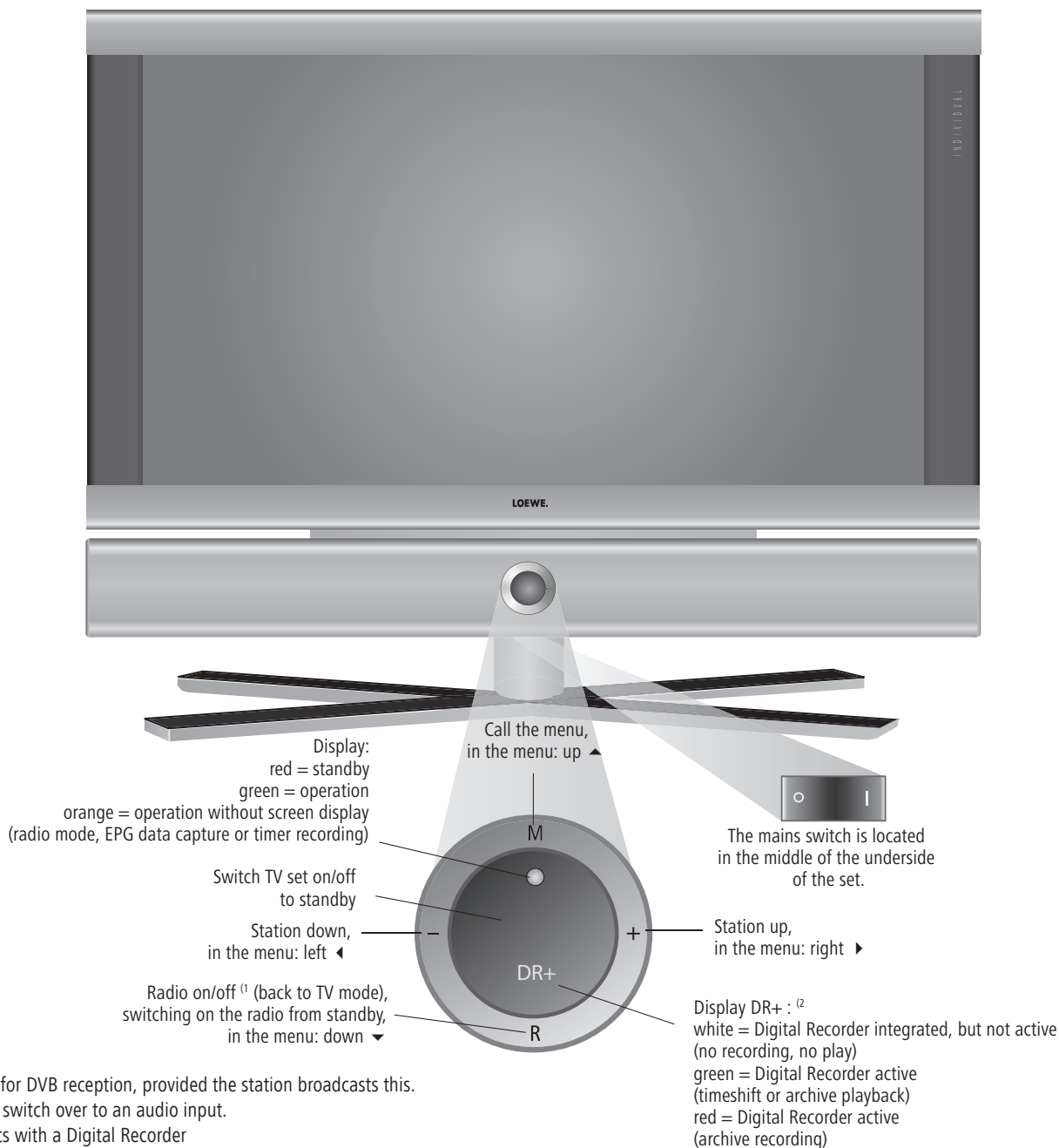

⁽¹⁾ Radio only for DVB reception, provided the station broadcasts this.
 Otherwise, switch over to an audio input.

⁽²⁾ Only for sets with a Digital Recorder

Connections to rear panel

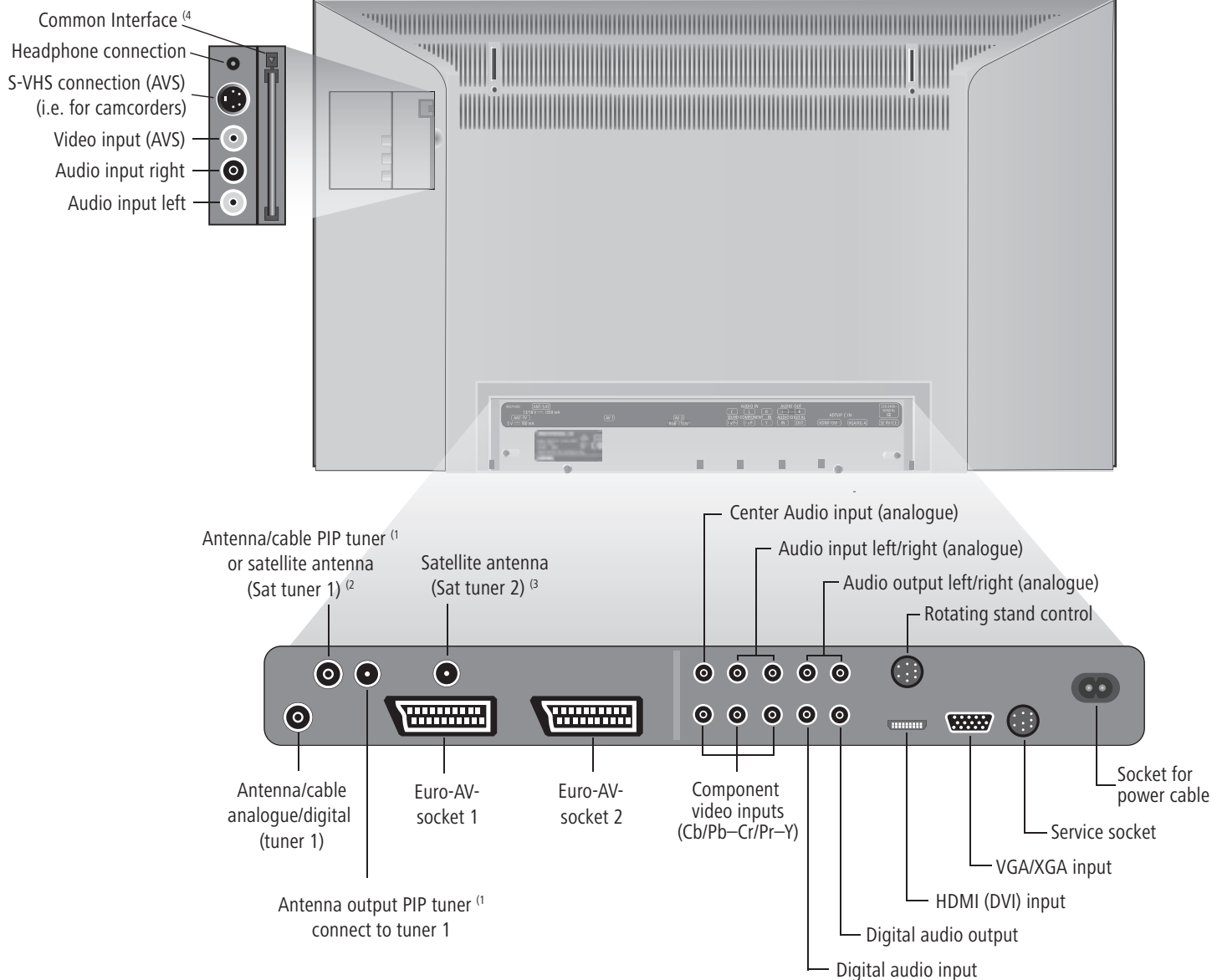

⁽¹⁾ Can be retrofitted. This is already integrated in sets with a digital recorder.

⁽²⁾ Digital satellite tuner can be retrofitted.

⁽³⁾ Can be retrofitted for sets with a digital recorder.

⁽⁴⁾ Only for sets with DVB-T/C CI or it can be retrofitted.

Welcome

Thank you!

At Loewe, we combine the highest standards of technology, design and user friendliness. This applies equally for TV, video and accessories.

Your new TV set is ideally equipped for the TV standard of the future - "HDTV" (High Definition Television). With its high-resolution screen and the future-proof digital interfaces HDMI, you have the option to view HD content with excellent picture quality. It therefore carries the European quality mark "HD ready".

Digital TV is steadily spreading via terrestrial reception, in the cable network and via satellite. Loewe supplies sets equipped with DVB-T and DVB-C (DVB-C not for UK). A digital satellite tuner (DVB-S) can be retrofitted. The DVB integrated within the TV set is operated via the TV set menus using the remote control.

We have designed this TV set so that it is easy to operate by using menus. Information about settings in menus is shown automatically; this enables you to understand the context quickly.

You will find the answers to many of your technical queries in the index of your TV. If you want to operate the TV, you can access functions directly from the index. This saves you from having to read through detailed operating instructions and is the reason why this operating manual only explains the most important operating steps.

Integrated features

The maximum equipment is described in these operating instructions (without optional retrofit kits). Functions indicated by * are not available in all TV sets. Menu contents may differ from the ones shown, depending on how your TV is equipped.

You can display how your set is equipped in the "Integrated features" index (press the **INFO** button in the TV mode if no menu is displayed; the "Integrated features" menu item is also displayed in the index before the initial letter A).

There are separate operating instructions for Digital Recorder Plus with the additional DVB satellite tuner.

Scope of delivery

- LCD-TFT TV set
- RC3 remote control with 2 batteries
- Table stand mounted
- Marketing and service card
- Fabric hose
- 3 binders
- These operating instructions

Transporting

Only transport the unit in an upright position. Hold the set by the top and bottom edges of the housing. The LCD screen is made of glass and/or plastic and may break if not handled carefully. Should the LCD screen become damaged or should the liquid crystal begin to leak, then it is imperative you wear rubber gloves when removing the set. Should the liquid come in contact with your skin, thoroughly rinse with water immediately.

Installation options

As a desktop unit

Use the stand included in delivery.

As a rotating desktop unit

- Motor Unit Table Stand, Loewe order no. 65489x00 (can probably be supplied from November 2005).

As a wall-mounted unit

- Wall holder WM55 for Individual 26 / Individual 26 Selection, Loewe order no. 65497A00.
- Wall holder WM54 for Individual 32 / Individual 32 Selection, Loewe order no. 65498A00.

As a free-standing unit

- Screen Floor Stand, Loewe order no. 65496x00.
- Screen Paravent, Loewe order no. 65494x00.

As a rotating free-standing unit

- Motor Unit Floor Stand, Loewe order no. 65489x10 (can probably be supplied from November 2005).

As an individual mounting solution

- Screen Lift, Loewe order no. 65486x00.
- Screen Ceiling Mount, Loewe order no. 65492x00 (can probably be supplied from December 2005).

Welcome

Note on the LCD screen

The TV set with an LCD screen you have purchased meets the highest quality requirements and has been tested for pixel errors. Despite the utmost caution in production of the displays, it cannot be totally ruled out that some of the pixels might be defective for technological reasons. Please understand that such effects cannot be considered a unit defect as defined by the warranty as long as they are within the limits specified by the standard.

Cleaning

Use only a soft, clean, damp cloth to clean the TV set, the screen and remote control (do not use any caustic or abrasive cleaning agents).

Note: The front screen (Individual Selection) is to be removed only by a specialist dealer.

Disposal

Packing and box

You have chosen a long lasting technical product of very high quality. We have paid a fee to authorised recyclers who will collect the packing from your dealer for disposal, pursuant to domestic regulations. Nevertheless, we recommend you to keep the original box and packing material for optimum protection if you have to transport the set.

The set



Attention: The EU directive 2002/96/EC regulates the proper way to recycle, handle and utilise used electronic devices. Hence, all used electronic devices are to be disposed of separately. Please do not dispose of this set in the normal household rubbish.

You may return your used set free of charge at designated recycling centres or at your specialist dealer whenever you purchase a new, comparable set. You can find out more about recycling (also for countries outside the EU) from your local government.

For your safety

For your safety and to avoid unnecessary damage to your TV set, please read and observe the following safety instructions:

- This TV set is designed exclusively for reception and reproduction of video and audio signals.
- This equipment is designed for domestic and office environments and must not be used in rooms with high humidity (e.g. bathroom, sauna) or high concentrations of dust (e.g. workshops). If the equipment is used in the open air, ensure that it is protected against moisture (rain, drips, splashes, sprayed water or dew). Do not place any containers filled with liquids or lit candles on top of the TV.
High levels of moisture and concentrations of dust cause leakage currents in the equipment, which can lead to danger of electric shock or fire.
The manufacturer's warranty is only valid for use in the specified permissible environment.
- If you have moved the TV set out of the cold into a warm environment, leave it standing for about an hour since condensation may form.
- This equipment must only be connected to a mains power supply which has the same voltage and frequency as that specified on the rating plate; use the power cable provided. Incorrect voltages can damage the equipment.
- Like all electronic equipment, your TV needs air for cooling. Obstruction of the air circulation can cause fires. Therefore the air vents on the back must always be kept free. Please do not place newspapers or cloths on/over the TV.

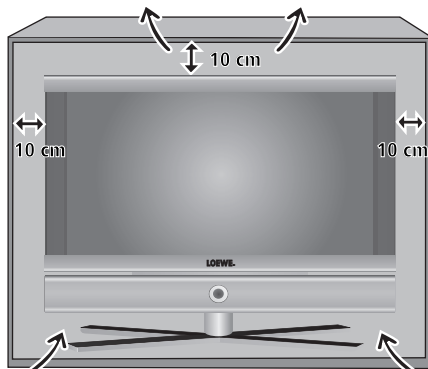
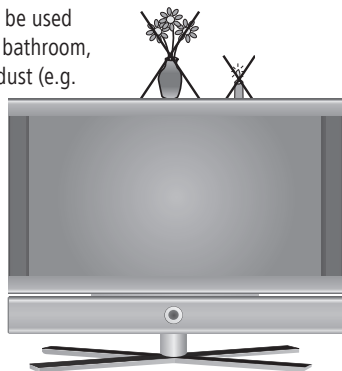

If the TV is placed in a cabinet or on a shelf, leave at least 10 cm at the sides and 10 cm at the top to ensure sufficient air circulation.

Position the set so that it is not exposed to direct sunlight and additional heating from radiators.

- Prevent any metal parts, needles, paper clips, liquids, wax or the like from getting into the TV set through the air venting slits in the rear panel. This can lead to short-circuits and possibly to fire. If something should get into the inside of the TV set, pull out the plug immediately and notify customer service.
- Never remove the back of the TV set yourself. Repair and servicing of your TV set should only be carried out by authorised TV technicians.
- Place the TV set on a level, firm base. The set should not protrude at the front when installing in cabinets or shelves.
Only use original accessories if possible, e.g. Loewe wall holders and stands.
Never let children handle the TV unattended.
Do not allow children to play in the immediate vicinity of the TV, they could knock, shift or pull it over and injure someone.
Never leave the TV on unsupervised.
- Do not install the TV where there may be vibrations. Vibrations can lead to material stress.
- Pull out the power and antenna cables during thunderstorms. Surge voltages caused by lightning strikes can damage the TV through the antenna system and the mains. Also remove the antenna and mains plugs in long periods of absence.
- The mains plug of the TV set must be easily accessible so that the set can be disconnected at any time.
- Lay the mains cable in such a way that it will not be damaged. The power cable may not be kinked or laid over sharp edges, not stood on and not exposed to chemicals, the latter also applies to the device as a whole. A mains cable with damaged insulation can lead to electric shocks and is a fire risk.
- When removing the mains plug, pull the plug housing and not the cable. The wires in the plug could be damaged and cause a short circuit the next time it is plugged in.

The rating plate is located on the rear panel next to the connections.

First installation

Remote control

Batteries

To insert or change the batteries, press on the arrow. Slide the battery compartment cover downwards and remove it. Insert LR 03 alkaline-manganese batteries (AAA) and ensure that the + and - ends are positioned correctly.

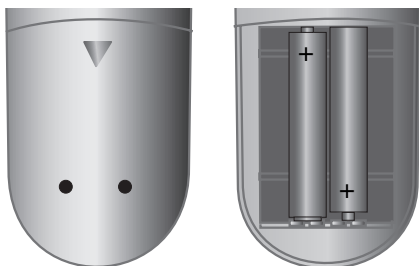

Then push the cover back on from the bottom.

Note on disposing batteries



The batteries provided contain no harmful materials such as cadmium, lead or mercury. Regulations concerning used batteries stipulate that batteries may no longer be thrown out with the household rubbish. Deposit any used batteries free of charge into the designated collection containers set up at commercial businesses.

Setting up the remote control for operating the TV

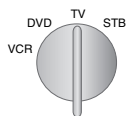

Set the rotary switch to "TV"

How to operate other equipment is described as of page 37.

Connection

Power mains

Remove the cover for the connections. Connect the TV set to a 220-240V/50- 60 hertz power outlet. Plug the small plug of the mains cable into the mains socket on the rear of the TV set; plug the large mains plug into a mains socket.

Antennas

Plug the antenna plug of your antenna/cable system or the room antenna for DVB-T into the ANT-TV socket (Tuner 1).

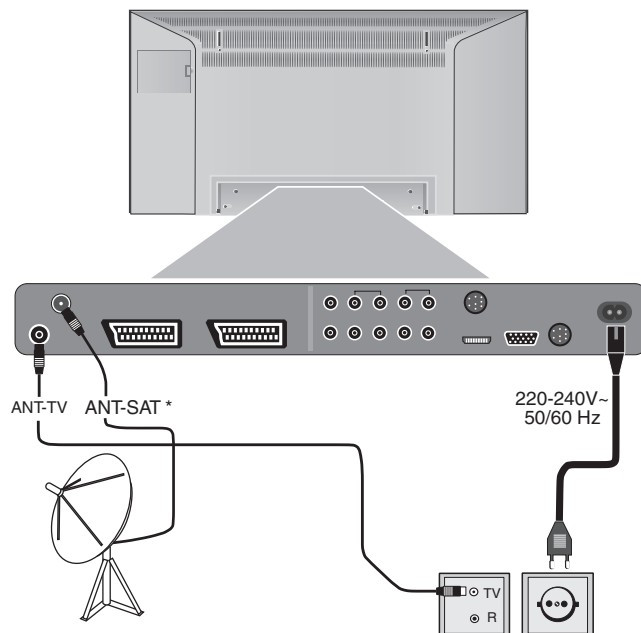

If the reception conditions are good, then a room antenna may be used for DVB-T. Passive and active room antennas are available on the market. The power is supplied for an active antenna via the antenna connection. For automatic programming or in "TV Menu – Connections – Antenna DVB – Antenna DVB-T," the distribution voltage (5 volts) is to be set correspondingly. It may be practical to use a nondirectional antenna. If the location is outside the normal transmitting range, then a unidirectional antenna may also be used to improve the reception quality. You can find out more on the digital stations that can be received in your area at your specialist dealer.

First installation

If a Individual 32 / Individual 32 Selection was retrofitted with a PIP tuner or if this is already integrated in a set with a digital recorder, the PIP tuner output has to be connected with the ANT-TV (Tuner 1). See illustration on page 5.

If a Digital Satellite Tuner 1 has been retrofitted, connect your satellite antenna system to the ANT-SAT socket.

If a Digital Satellite Tuner 2 has been retrofitted (only in conjunction with the Digital Recorder+), then connect one antenna cable each, for example from the antenna switch or from the twin LNC, to both SAT sockets.

Handling the fabric hose



Use the fabric hose included to lay the mains cables, antenna cables or cables from other electronic components systematically; then lead the hose with the cables to the connection boxes. This provides you with an elegant solution when laying cables.

The diameter of the fabric hose increases when you push it together lengthwise (see illustration). This makes it easier for you to push through cables with plugs.

Use of the binders



The enclosed binders are intended to bind the connecting cables together and fix the cables to the mount of the table stand (see figure).

By pressing on the closure of the binder, it can be opened again.

Replace the connection cover on the TV set.

Using the common interface module

(only for sets with CI slot)

In order to be able to receive encrypted digital stations, the common interface module (CI module) and the smartcard both have to be inserted into the corresponding slot of your TV set. You can purchase the CI module and smartcard at your specialist dealer. You can find the slot on the back of your TV set, see the illustration on page 5.

1. Make sure the TV set is switched off with the mains switch on the set, or pull the mains plugs.
2. First push the smartcard into the CI module as far as it will go. Insert it so that the side with the golden contact chip faces the side of the module printed with the supplier's brand logo. Printed arrows indicate how to insert the card. Also follow the installation instructions included with the smartcard.

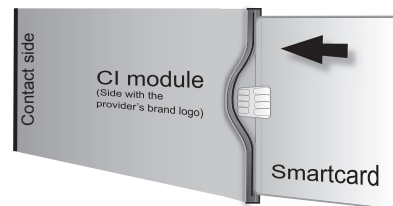

3. Slide the CI module ⁽¹⁾ carefully into the slot with the contact side facing the front. The logo on the common interface module should be visible. Make sure the module is not twisted in the process. Do not use force. When the module locks, the eject button is pressed outwards.

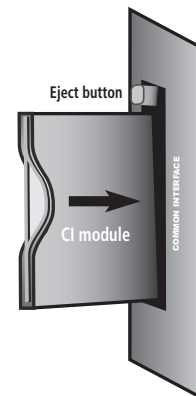

⁽¹⁾ The CI module and the smartcard are not included in the scope of delivery of this set; you can usually obtain them at your specialist dealer.

Switching on



Press the mains switch, the red indicator on the set now lights up (standby mode).



Switch on the set using the switch integrated in the indicator (for further operating options see page 12).

First installation

Automatic programming

Automatic programming of the TV set is started the first time you switch it on. Follow the menus.



By pressing in one of the arrow directions, you can choose the settings ...



... and confirm your settings by pressing OK. You then go to the next menu.



Back to the previous menu.

1. First you have to select the menu language.
2. By pressing the **OK** button, you can call the menu "Connect antenna cables(s)". If you want to receive digital stations via satellite, then choose "DVB-S" - confirm using the **yellow** coloured key. If you also want to receive digital terrestrial stations (DVB-T), then select "DVB-T". Also select "Antenna/cable (analogue)" - this way the standard analogue stations can also be searched for and saved. If you can receive digital stations from the cable network, then select "DVB-C" using the **yellow** coloured key.
3. For the country-specific station sorting, enter the location.
4. If you have selected "DVB-T", you then reach the menu "Antenna DVB-T". If you use an active antenna, then select "yes (5V)".
5. In the "Select satellite installation" menu, make the selection that corresponds to your satellite antenna installation.
Note: If you have any questions on how your satellite antenna installation is configured and on the antenna settings, consult your antenna installer or your specialist dealer.
6. Select the satellite the antenna is directed at, such as ASTRA1. If you only receive one satellite ...
7. In the following menu, specify whether the station search should take place in the high and low band ("Yes") or only in the low band ("No").
Note: For most satellites, a station search is required in both bands.
8. For the low band and high band, the standard frequencies 9750 MHz (9.75 GHz) and 10600 MHz (10.6 GHz) are preset.
If your satellite antenna is equipped with an LNC (LNB) with a divergent oscillator frequency, specify the corresponding frequency for low and high band respectively. Note: The correct display of the received frequencies in the "TV menu – Settings – Channels – Manual adjustment" depends upon this setting.

Initial installation	
Connect antenna cable(s)	
Antenna cable(s) for:	to antenna socket(s):
Antenna/cable (analogue)	ANT TV <input checked="" type="checkbox"/>
DVB-T	ANT TV <input checked="" type="checkbox"/>
DVB-C	ANT TV <input checked="" type="checkbox"/>
DVB-S	ANT SAT
<input type="checkbox"/> Proceed	<input type="checkbox"/> Connect/disconnect
	<input checked="" type="checkbox"/> Back

9. You should receive a picture with sound with the settings previously made (only for ASTRA 1 and HOTBIRD). Then press **OK**.
10. In the "Pre-programming" menu, select the factory-set pre-programming to programme the satellite stations quickly.
To ensure all stations that can be currently received are searched for and saved, select "No" at this point.
Symbol rates: The standard symbol rates 22000 and 27500 are preset. If you would like to receive stations with different symbol rates, specify the corresponding values here using the numeric buttons on your remote control.
11. Press **OK** to obtain an overview of the settings with which the automatic programming is to take place.
12. Press the **OK** button again and the station search will start. The TV set searches for, sorts and saves all the TV stations that can be received, according to your settings and the antennas connected.
13. When the TV stations are saved, you will receive a corresponding message.
14. Press the **OK** button and the set then searches for the radio stations.
15. The TV set searches for, saves and sorts all radio stations which can be received with your antenna system.
16. Then log on your video equipment, decoder and audio system using the connection wizard and connect these to the TV according to the connection diagram displayed. If you want to connect other equipment later, you can find information as of page 30.

You can repeat the initial installation at any time, e.g. after moving house. Call the index using the **INFO** button (in the TV mode, if no menu is opened). Select the index item "Repeat initial installation" (you will find this listed separately before the letter A). Press **OK** to start the initial installation.

Note: For DVB-T stations in UK the stations are tied to "Logical Channel Numbers" – "LCN" and sorted from 1-799. Digital stations without "LCN" are stored from 800 onwards. Analogue stations are stored from 1001.

Station sorting

Note: not with DVB-T stations in UK.

You can change the station sorting that was carried out automatically later at any time, see "TV menu – Settings – Channels – Change stations".

First installation

Directing DVB-T antenna

Note: not with DVB-T stations in UK.

If you use a room antenna to receive one or more DVB-T stations that have picture and sound interference, then you should change the location of where the antenna is set up.

To help you direct your antenna or to help you determine the most suitable location to set up the antenna, your TV set has a display for the signal quality **C/N** and the signal strength **Level**.

Consult your specialist dealer to find out which channels and frequency bands (VHF or UHF) are used to broadcast the digital TV stations in your area.

On any one channel, several digital stations are broadcast.

Select a TV channel

1. Call the "TV menu" via the **MENU** button.
2. Use **◀ ▶** to select "Settings", then use **▼** to select the menu line underneath.
3. Select "Channels", then use **▼** to select the menu line underneath.



4. Select "Manual adjustment" and call the menu using **OK** (in UK, the manual adjustment does not work with DVB-T).

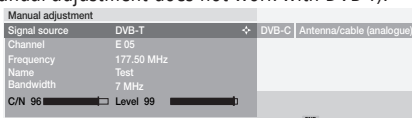

5. For digital stations, select "Signal source – DVB-T".
6. Use the **numerical buttons** to specify the corresponding channel number. Depending on the channel selected and country, the system automatically sets the corresponding bandwidth of 7 or 8 MHz. You should only change the bandwidth under special circumstances - if the channel raster in your area is different from the standard. When you receive a digital station, the system displays the signal quality **C/N** via a bar/numeric value and the signal strength via **Level**. The antenna's direction or position is best when the largest values possible are displayed (long bar) for the signal quality and signal strength.
7. Direct the antenna so that the largest numerical value/bar size is reached.
8. If no signal is found in the channel set, you can start the frequency search run by pressing the **blue** button within the band selected (VHF or UHF).
9. Check the other channels one after another on which digital stations are broadcast terrestrially in your area. For the weakest station, direct the antenna so that the maximum numerical value/bar size is achieved.
10. After you position or direct the antenna, we recommend to search for all the stations using the "Search wizard" (TV menu – Settings – Channels – Search wizard).

Daily operation

Switching on/off

Your TV is equipped with an eco-standby power supply unit. On standby, the power consumption drops to low power. If you want to save even more electricity, switch the set off with the mains switch. However, please bear in mind that EPG data (electronic programme guide) will be lost and programmed timer recordings will not be performed by the TV.

Switching off

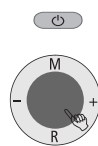

If the TV set is switched on, you can switch it to standby using the blue ON/OFF button on the remote control or by using the indicator field on the set. The red lamp on the TV set lights up. If the orange indicator lights up, a timer recording is being made, EPG data is being captured or radio operation without screen display is active.

Switching on the TV set

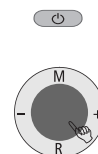

From standby, it is best to switch the set back on using the blue On/Off button or by using the numeric buttons of the remote control (1 – 99).

Or use the switch integrated in the indicator on the set. The green indicator on the TV set lights up.

Or switch on the TV set with **OK**, you can then see the station list and select a station.

Switch on the radio

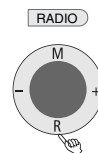

With the **RADIO** button on the remote control or:

Switch on radio using **R** on the control ring of the TV set.

If you switch off the TV set using the mains switch on the set, the indicator no longer lights up.

If the TV set is switched off via the mains switch, you have to switch it into the standby mode first via the mains switch and then switch it on using one of the above mentioned methods.

Daily operation

Changing stations

... with the P+/P- buttons on the remote control

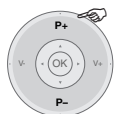

Stations up/down

When changing, the station display is visible for a few seconds.



If additional languages are broadcast with DVB stations, then the set displays the language/sound selection under the station display. Call the language/sound selection by using the **green** coloured key and select using \blacktriangle \blacktriangledown .

... with the numeric buttons of the remote control

The set has a dynamic memory with 1680 station memory locations. If up to 9 stations are stored, you only need to enter one digit; up to 99 stations, two digits are needed; up to 999 stations, three digits are needed (refer to the station list to see how many stations have been stored).

7 pqrs
long

1 digit stations

Press buttons 0-9 for one second, and the station changes instantly.

Or press button 0-9 briefly, the station then changes after 2 seconds (the station changes immediately when only 9 stations are saved).

1 2 abc 7 pqrs
short short long

2- and 3-digit stations

After briefly pressing the first numeric button(s), keep the last numeric button pressed for one second, the station then changes automatically.

Or press all numeric buttons briefly, the station then changes after 2 seconds (the station changes immediately if up to 99 or 999 stations are saved).

1 2 7 8 tuv
all short

4 digit stations

Press the four numeric buttons briefly, the channel then changes immediately.

... via the station list



Use **OK** to call the station list

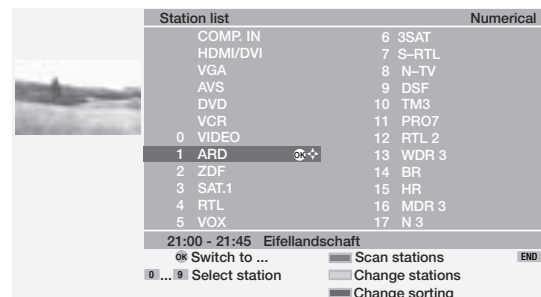

Select the station (if possible, the selected station will be displayed as a small picture) or ...



... select with numeric buttons



call selected station



Blue coloured key: sort alphabetically/according to bouquets/numerically

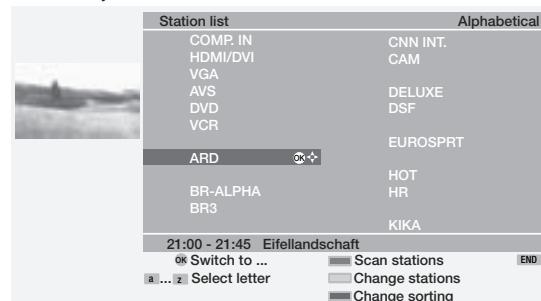

For an alphabetical display: Enter letters with the numeric button (like on a mobile phone keypad), select with \blacktriangledown \blacktriangle \blacktriangleleft \blacktriangleright and call with **OK**.

For bouquet display (sorting according to broadcasting chains, only for DVB stations, not for DVB-T stations in UK): Enter bouquet number, select with \blacktriangledown \blacktriangle \blacktriangleleft \blacktriangleright and call with **OK**.

Digital stations are indicated by **D**; encrypted stations are indicated by **D** . Child-protected stations are indicated by .

Call last viewed station (for DVB-T stations in UK)



You can switch back and forth quickly between two stations using this button.

Daily operation

Basics about the menu operation

Menus are called via the **MENU** button or via the button for special menus and can be hidden by using these buttons or by using the **END** button. The menu is displayed in the bottom section of the screen. At the top, you can see additional information for the menu point selected. In the menus, navigate by using the cursor \blacktriangle \blacktriangledown \blacktriangleleft \blacktriangleright . You can make settings by using \blacktriangleleft \blacktriangleright . When you exit the menu, the settings are adopted.

Example of the menu operation

We shall demonstrate how to navigate with the menus using the TV menu as an example. You can see which buttons you can use in the dark blue field on your TV set.

MENU

Open TV menu (in TV mode).

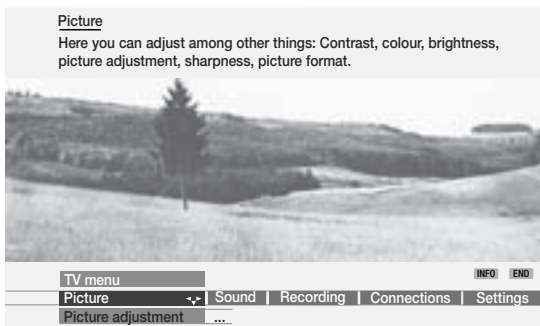

Select the function in the TV menu, e.g. "Sound" (for sound settings). Use \blacktriangleright to move the menu points displayed on the right into the dark blue field; use \blacktriangleleft to move the menu points displayed on the left.

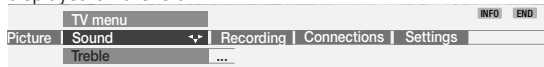

Select the sound function below with \blacktriangledown or **OK**; you will then see a list of the sound settings.

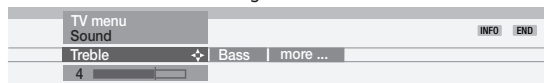

In the sound settings, also select the function with \blacktriangleleft \blacktriangleright , e.g. "Bass" (for increasing or reducing the bass tones).

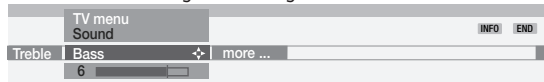

To set the bass tones, use \blacktriangledown or **OK** to select the setting bar underneath.



Set the bass tones by using \blacktriangleleft \blacktriangleright .

If you want to make other sound settings, move up with \blacktriangle to "Bass" and select with \blacktriangleleft \blacktriangleright , e.g. "more...". You can also move up further to "Sound" by using \blacktriangle and select other settings in the TV menu (such as, picture settings).



Use **OK** to call additional sound settings.

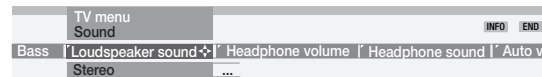

Select the sound setting using \blacktriangleleft \blacktriangleright , e.g. "Auto volume" and ...

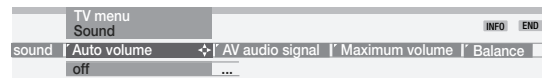

... use \blacktriangledown to select the auto volume option.

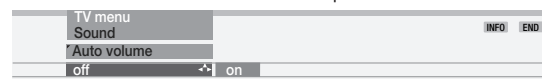

Use \blacktriangleleft \blacktriangleright to select "on" and activate the auto volume.

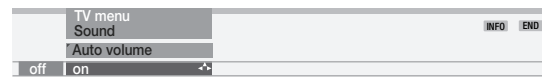

END

Press the **END** button to hide the menu.

Apart from the TV menu shown here, other menus can be opened in TV mode as follows:



Call the Sound menu directly.



Call the Picture menu directly.



Quick calls for Image+*, teletext subtitles, personal text pages, headphone volume, scan stations and to move the picture up and down.



Green coloured key: Call standard settings for picture and sound.

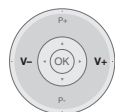

Using the volume control, you can also open other sound settings, such as Sound via, Sound adjustment, Sound effects and Loudness.

The key \blacktriangle or **OK** must be pressed for the duration of the volume display for this.

Daily operation

For the info system ...

For each menu point, an info text is displayed at the top of the picture to help you with the setting. This saves you from having to refer back to the operating instructions. We shall demonstrate this using the station search option as an example:

 Call the TV menu.

 Select "Settings".

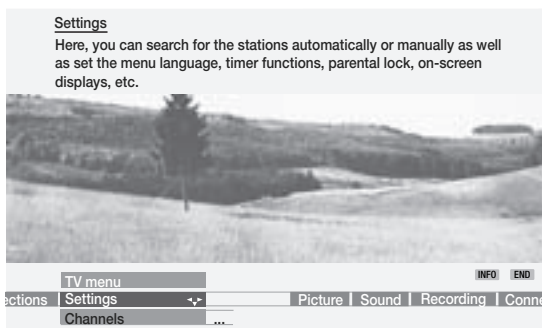

In this example, you can see the options available after "Settings".

 If you want to search for new stations, for example, use ▼ to select "Channels" in the line below.

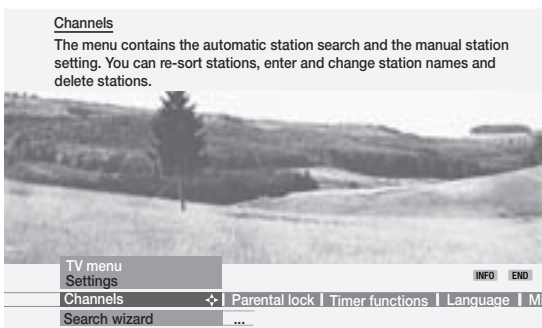

The info text indicates which settings you can make in "Channels".



Use ▼ to select the line below, for example "Search wizard".

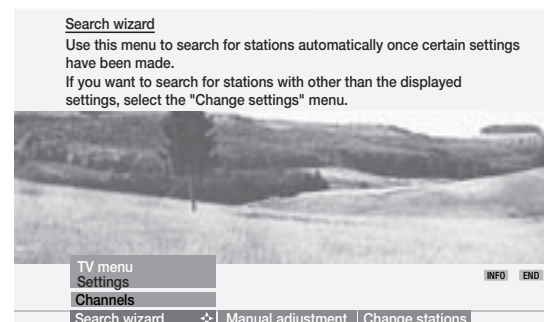

The info text explains how you are to proceed.

Upon delivery, the TV set is configured so that the info texts are always displayed (Automatic info "yes"). In this case, you can hide the info texts by using the **INFO** button.

You can also configure the TV set so that you call the info texts when needed by using the **INFO** button (Automatic info "no"). You can find the setting to switch the automatic info option on or off via "TV menu under Settings – Miscellaneous – On-screen displays – Automatic info – yes/no".

Daily operation

For the index ...

Using the index, you can access many operational functions directly. You can also find a great deal of information on technical terms about television. Before the alphabetical sorting, you can find the menu language option, the list of features integrated into the TV set and the repeat initial installation option.

INFO

Call the index in the TV mode (without any other on-screen displays).

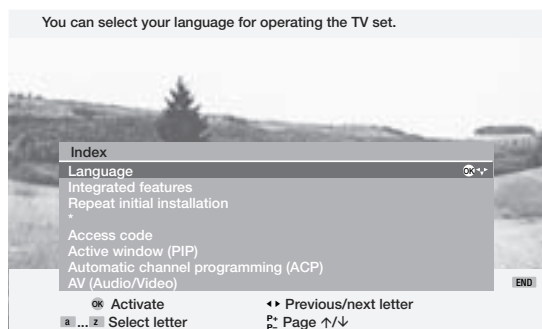

Info on the index item selected is visible at the top of the picture. If the **OK** symbol is displayed in the line selected, you can use the **OK** button to access the menu directly and carry out settings or selections.

This is how to select the index item:

2 abc

Enter the first letter using the numeric buttons on the remote control (like on a mobile phone keypad);

9 wxyz

or



use to go to the previous/next letter,
or

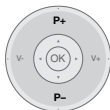

use P+/P- to scroll up or down through the pages



and use to go from line to line.

For example, you want to have the TV set switch off automatically:

Select the index item "Switch off" – "Automatic".

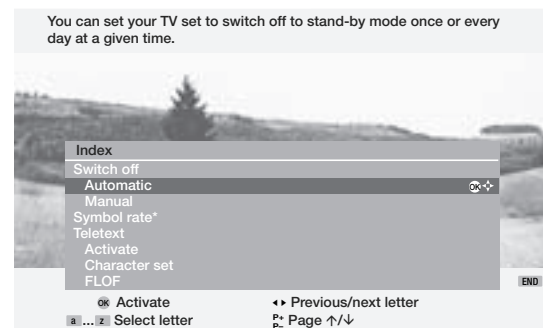

Use the **OK** button to call "Switch off" – "Automatic".

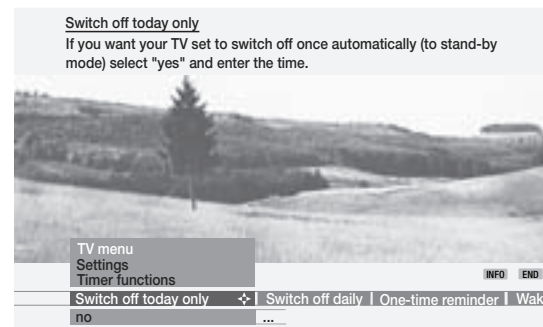

The corresponding menu "Timer functions" is displayed (in the TV menu – Settings). You can now choose between "Switch off today only" and "Switch off daily" and enter the time.

Daily operation

Setting the sound

Volume and other frequently used sound settings

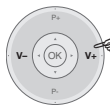

Setting the volume



by using \blacktriangle or **OK**, you can call other sound settings ...

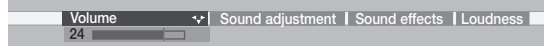

and select using \blacktriangleleft \blacktriangleright ...

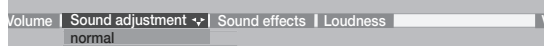

use \blacktriangledown for the related selection/setting...



... and use \blacktriangleleft \blacktriangleright to make the selection/setting there.



Sound adjustment allows you to adjust the sound characteristics to the station's sound. The Sound effects settings allow you to expand a Dolby Pro Logic Signal to a virtual surround signal by using "Dolby Virtual"; by using "Panorama", you can enhance the foundation of the stereo sound virtually for the loudspeakers.

Sound off/on



Sound off;
Sound on: Press button again or adjust volume.



Other sound settings:



Call the Sound menu

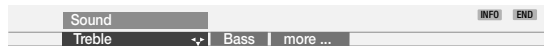

use \blacktriangleleft \blacktriangleright to select the sound function to be set and use \blacktriangledown for the related selection ...

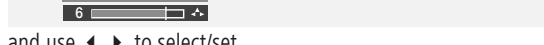
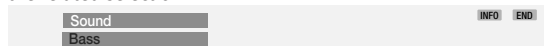

and use \blacktriangleleft \blacktriangleright to select/set.



Sound settings: Treble and bass. Different menu items are displayed depending on the connected audio device (AURO, hi-fi amplifier). Under "more ..." you will find the sound selection for loudspeakers and headphones, auto volume, headphone volume, AV audio signal, maximum volume and balance.

Picture settings



Open the Picture menu

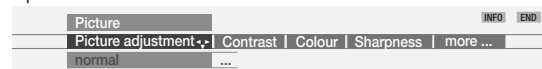

use \blacktriangleleft \blacktriangleright to select the picture function to be set and use \blacktriangledown for the related selection ...

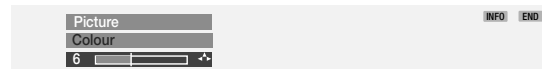

... and use \blacktriangleleft \blacktriangleright to set/select.



Picture settings: Picture adjustment, Contrast, Colour, Sharpness. Under "more ...", you can find settings for Brightness, Image+*, Picture format, Move picture up/down, Auto format and Film quality improvement DMM*.

Direct control on TV set

On page 4, you can find illustrations of the control unit located on the set.

Switching station on the TV set

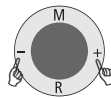

Station up: with + on the control ring

Station down: with - on the control ring

Switching the radio on/off or switching over to the radio

Press **R** to switch the radio on or off.

Additional functions via the menu

In the radio or TV operating modes, you can make settings for Volume, Brightness, Contrast, Picture format and Stations. "Service" is intended for the customer service department.

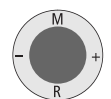

use **M** to call the menu

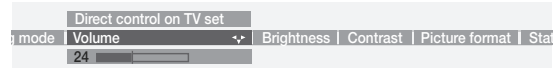

use - or + to select the function to be set



use **R** for the related setting/selection

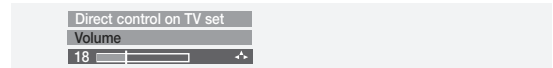

use - or + to set/select.

Use **M** to move one level up; you can use - or + to select other functions.

Operating modes – TV

TV

In initial installation and daily operation, the TV set is in TV mode. This is also the case when none of the other modes of operation, such as EPG, Teletext, PIP or Radio, have been selected.

Each of these operating modes has a separate menu with separate functions for the coloured keys. Call the menu via the **MENU** button.

How the coloured keys work in TV mode

Note: The coloured keys do not work as described below with DVB-T stations in UK, but they operate as described on page 28 (Digital Teletext).



Red: the TV picture freezes. Pressing this button again starts the picture moving again. If your TV set is equipped with a digital recorder, the DR archive is called.

Green: Call personal settings/factory settings for picture and sound, save picture and sound settings as personal settings.



Yellow: call last station viewed. You can switch back and forth quickly between two stations using this button.

Blue: call programme info.



Show status display

END

Show/hide status



In the line above, you can see the name of the station and the sound mode. Displayed below are additional options (Time, Sound mode, Alarm time and

Sleep timer) that can be selected in the "TV menu – Settings – Miscellaneous – On-screen displays".

For the status display, the DVB station providers may offer additional selection options for each station. Thus, the corresponding colour key or the **TEXT** button is displayed:



Red: channel selection for multi-channel providers.

Green: language/sound selection.

Yellow: time selection.

Blue: protection of minors.

TEXT

DVB subtitles.

If you press one of the coloured keys during the status display or you press the **TEXT** button, the related selection menu is displayed.

The status display subtitles refer only to the "DVB subtitles" and are not provided by all stations. The options you see depend on the particular station (many stations broadcast subtitles via teletext).

The status display is displayed automatically when a new programme begins with options different to the previous one.

Notes:

- In the sound mode, Mono! means that you have switched manually from stereo to mono, for example.
- The selection menus are only available as long as the status display is displayed. You can call them again at any time by pressing the **END** button on your remote control.

Calling the index

INFO

Calling the index

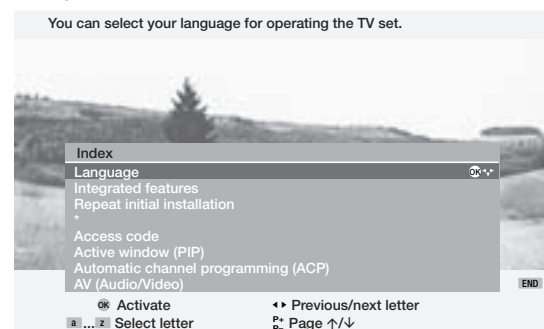

You can find more information on the index on page 18.

Operating modes – TV

Call additional functions



Select additional functions such as Image+ *, Teletext subtitles, Personal teletext pages, Headphone volume and Scan stations.



Call timer overview



If timer recordings have been programmed, you will see when which station is recorded here.



Select picture format



The TV set sets the best picture format automatically when Auto format is switched on. If you want to set a different format, press this button until the desired format is selected or select the format with ◀ ▶.



Move picture up/down



To make picture subtitles visible, you can use ▲ ▼ to move the picture up or down with the picture formats "Panorama", "Cinema" and "Zoom".

Note: for DVB-T stations in UK you can switch back and forth quickly between two stations using this button.

TV menu



Call up the TV menu

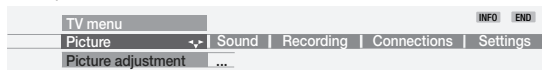

You will find a description of the picture and sound settings on page 17. The TV menu offers other options for recording, connections and settings of the TV set.

For a recorder that is logged in, you can find the following menus in the "Recording wizard":

Recording wizard - to programme new timer recordings

• Via EPG (not for DVB-T in UK) • Via teletext • Manual

You will find further information about timer recording on page 31.

Timer list

Here you will find a list of programmes programmed for recording. You can change the recording data or delete programmed recordings and programme new recordings.

Pre-record time and Post record time

For recordings without VPS/PDC, set a lead and lag time here so that the programme is fully recorded despite any slight differences in the time.

Under "Connections" you will find the following functions:

New devices/modifications (connection wizard)

The connection wizard helps you connect and log in additional equipment such as video recorders, DVD players/recorders, camcorders/digital cameras, pay TV decoders, equipment with component signals and digital HDMI/DVI signals.

Antenna DVB

• Antenna DVB-T • Antenna DVB-S ⁽¹⁾

You can find more information on pages 11 and 12.

Digital Link Plus

Transmission of the station data from the TV set to the video/DVD recorder if a recorder with Digital Link Plus is connected.

Miscellaneous (connections)

- Set AV norm for the connections manually (if it is not recognised automatically).
- "Assign audio digital signals" to one of the AV sockets.
- "Allow switching voltage" to display the signals of the connected device immediately on the screen via Euro AV during playback.
- RGB insertions at AV2 to play back RGB signals at all station storage locations.
- Select decoder stations and set sound encoding.

Under "Settings" you will find the following functions:

Channels

Here you can search for and store new stations automatically or manually. With "Change stations", you can rearrange and delete the stations and change station names (not for DVB-T stations in UK).

- Search wizard • Manual adjustment • Change stations

⁽¹⁾ only for sets with DVB-S

Operating modes – TV

Parental lock

You can lock the TV “immediately”, “daily” for a certain period of time or “age-related” for DVB programmes with age restrictions.

Here, you determine the PIN to enter if you want to watch locked programmes.

Timer functions

You can have your TV switch off at pre-programmed times or wake you/remind you with radio or TV. If you are not present at the time, a safety prompt makes sure the TV switches off again after 5 minutes.

- Switch off today only
- Switch off daily
- One-time reminder
- Wake up Mon-Fri
- Wake up Sat
- Wake up Sun
- Wake up with *
- Wake up signal volume

Language

If “your” menu language is not set, you have to select the “Language” menu in a language that you do not understand. Therefore here is a simple way to set the right menu language:

1. Press the **INFO** button (index), select the first listing (this is above A).
2. Call the language selection by pressing the **OK** button.
3. Now select the desired language and confirm it by pressing the **OK** key.
4. Hide the menu again with the **END** button.

Miscellaneous (settings)

On-screen displays

You can set the duration and position of the station and status display, define the content of the status display and switch the automatic info texts on or off:

- On-screen display time
- On-screen display position
- Programme title
- Sound mode
- Time
- Alarm time
- Sleep timer
- Automatic info

Time and date

If you receive teletext, the set registers the time and date. These are required for timer recordings, timer functions and EPG. If you do not receive teletext, then you have to enter the date and time; you should not switch off the set using the mains switch since the settings will then be lost.

DVB software

Update of DVB software via satellite ⁽¹⁾.

DVB subtitles

- Subtitles off
- Subtitles for the Hearing Impaired
- Subtitles as translation for foreign language programmes

DVB character set

- Western European
- Polish
- Standard.

Rotate TV

The TV set can be rotated on a Loewe rotating stand. You can find out more on page 39.

DVB subtitles

If the station provides DVB subtitles, then you can have the TV display them permanently or suppress their display. You can also select between subtitles “for translation” or “for the Hearing Impaired”.

1. Call the “TV menu” via the **MENU** button.
2. Select the “Settings” line and confirm using **OK**.
3. Select the “Miscellaneous” line and confirm using **OK**.
4. Select the “DVB subtitles” line and confirm using **OK**.



Note: If you have selected “Subtitles off”, then the set generates an on-screen display when subtitles are available.

By using the **END** button, you can open the status display and you can display the subtitles again by using the **TEXT** button.

- Call the status display by pressing the **END** button, if it is not yet displayed.
- When the status display is visible, press the **TEXT** button. Select the desired language and confirm using **OK**. The presetting changes for the current programme.
- Which subtitle languages can be selected depends on the provider.
- The automatic shortlist is determined by the menu language and the selection made in the “DVB subtitles” settings menu.
- By pressing the **END** button, you can hide the menu again.

Note: DVB-T subtitles are not available when Digital Teletext is selected.

⁽¹⁾ only for sets with DVB-S

Operating modes – TV

Removing the CI module

1. Switch the TV set off by pulling the mains plug from the power outlet.
2. Remove the cover from the back of the set on the upper left.
3. Press the eject button at the module slot; the module is unlocked.
4. Remove the module from the set.

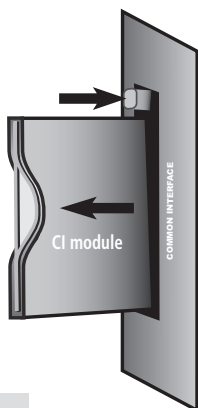

Inserting a new CI module

After you insert a new CI module and switch the TV set on, the following dialogue is displayed:

Autom. station search

Your TV set has detected a new CI module. This requires a station search for all new receivable stations.

After you press the **OK** button, the system starts the wizard to carry out the automatic station search. Check the proposed search parameters and let the set search for new stations.

Calling the CI module menu

Here you can call up information on the inserted common interface module and the smartcard. To do this, use the **MENU** button to call the TV menu, select the line "Settings", "Miscellaneous" and then the entry "CI module - xxx" (in place of "xxx" stands the name of the provider which is output by the smartcard. The content of this menu depends on the particular supplier of the CI module.

Note: This menu is only available for digital stations

Installing new DVB software

To ensure your DVB-S receiver is always performing at the state of the art, newly developed software versions are made available from time to time; these are broadcast via satellite and can be automatically installed on your set (only possible via ASTRA1).

Software is recognised automatically

The set can determine whether a new software version is available. This occurs at night when your EPG is automatically updated. For this, your TV set has to remain in the standby mode (do not switch off using the on/off button on the set).

If a new software version has been found, the set will indicate this with an on-screen message the next time the set is switched on: You can decide whether or not you want to download the new software.

Confirm using **OK**, so that the new software can be loaded and installed via satellite. Continue as set out in the "Downloading software" section.

Searching for new software

If you want to carry out a manual search for new software, proceed as follows:

1. Call the TV menu using the **MENU** button.
2. Confirm the "Settings" using **OK**.
3. Confirm the "Miscellaneous" using **OK**.
4. Select "DVB software" and press **OK**.

Update digital TV software

Current version: V3.x.x

You can search for a new software version with **OK**.

5. If you start the search using **OK**, the set checks if there is a new software version available.
6. If there is a new version available, the set generates an on-screen message.

Update digital TV software

Current version: V3.x.x

New version: V3.1.0

Downloading software

1. If you press **OK** in the dialogue above, you can decide whether you want to download the new software immediately, when you switch off the set or not at all. We recommend you always carry out the update of the digital software. This is the only way to ensure your set is always up to date.
2. If you do decide to update, the software is initialised on your set and you are informed of the status with a grey bar.
Do not switch your set off during this time. This process may take up to one hour. You will be informed when the process is completed.
3. After the software is updated, you will be asked to switch your TV set off and back on again using the on/standby switch.

If the update was not carried out, you will be asked several times when you switch on the set whether you want to carry out this update.

Operating modes – TV

Image+

Image+ is a picture improvement specially developed by LOEWE, which delivers a sharper, lifelike and colour-fast picture richer in detail and contrast. Image+ is only integrated in the set Individual 32 Selection.

Image+ menu



Call the menu "Additional functions".



Use \blacktriangledown to move to the corresponding selection/setting...



and use \blacktriangleleft \blacktriangleright to select/set and use...



to activate.

In the Image+ menu, the functions Image+ "on", "off" and "Demo" can be set. The Image+ settings can also be opened via the "Picture" menu.



Open the Picture menu

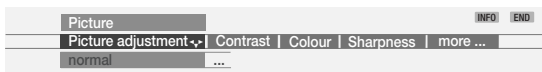

use \blacktriangleleft \blacktriangleright to go to more... and select with OK



Select/set as described in the Image+ menu.

The standard setting at delivery of the set is Image+ "on".

Image+ demo mode

In order to show the way Image+ works, a "Demo mode" is integrated. In "Demo mode", the current picture is divided into two parts. The left half of the picture is shown in "normal" mode, the right half in the Image+ optimised mode.

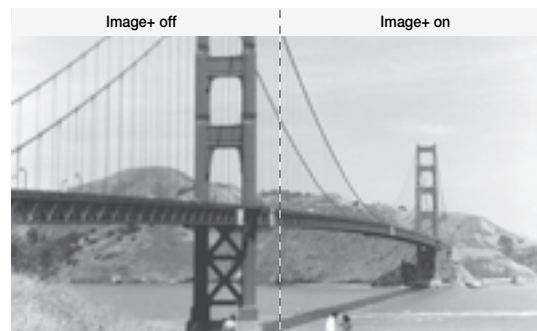

The demo mode can be closed by pressing on any button on the remote control.

Operating modes – PIP

Picture in picture (PIP)

Note: The coloured keys do not work as described below with DVB-T stations in UK, but they operate as described on page 28 (Digital Teletext).

Picture in picture displays are possible if the set has an analogue PIP tuner or a digital satellite tuner in addition to the analogue TV cable tuner. You can have a PIP tuner (not for Individual 26 / Individual 26 Selection) or a digital satellite tuner (not for UK sets) retrofitted. If there is no other tuner installed, you can use PIP (AV-PIP) when playing a video recorder or DVD player.

For a retrofitted PIP tuner, the following PIP displays are possible: Main picture analogue – PIP picture analogue, Main picture digital – PIP picture analogue. The following is not possible: Main picture digital – PIP picture digital, Main picture analogue – PIP picture digital.

For "Split screen," the PIP picture is displayed on the right side of the screen. Both pictures share the screen in two equal halves. For the "Small PIP" setting, a small picture is displayed in the TV picture.

The green bar/frame indicates that the control commands have an effect on the PIP picture. The white bar/frame means that the control commands have an effect on the main picture. Use the **green** coloured key to switch between the PIP picture and the main picture, for example to change stations.

The frame or bar between the pictures is green for the time being.

PIP Show/hide PIP picture

PIP picture as freeze picture

The bar/frame has to be green. If not, press the **green** coloured key. If you press the **red** coloured key, the PIP picture freezes. Press again - moving picture.

Selecting the station of the PIP picture

The bar/frame has to be green. If not, press the **green** coloured key. Then select the station as usual.



Select the station of the TV picture (main picture)

The bar/frame has to be white. If not, press the **green** coloured key. Then select the station as usual.

Note: For UK sets, you switch from the green bar/frame to the white by using the **PIP** key. The next time you press the **PIP** key, PIP is switched off.



PIP scan in the PIP picture

The bar/frame has to be green. If not, press the **green** coloured key. Start scanning the stations using the **blue** coloured key. The bar/frame turns blue.

The stations now change automatically. Stop scanning the stations by using the **blue** coloured key. The bar/frame turns green again.

Interchanging PIP picture/TV picture

The bar/frame has to be green. If not, press the **green** coloured key.



Operating modes – PIP

Functions in the PIP menu

In the PIP menu, you can set the PIP type (small picture or split screen) and the position of the small picture.

MENU Call the PIP menu (PIP must be active, green bar/frame)

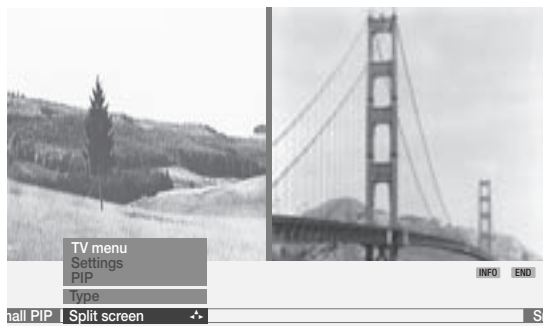

Setting the PIP type

You can have the PIP picture displayed as a small PIP or split screen.

Switch to small PIP:



Select "Type" and then "Small PIP"



For the small PIP, you will see a coloured frame around the PIP picture.

Position of the PIP picture



Move the PIP picture with the arrow keys to a corner of the TV picture. In this case, the frame around the PIP picture has to be green, and there should not be any other displays visible on the screen.



Switch to split screen:

You can have the PIP picture displayed on the right hand side of the screen. Both pictures share the screen in two equal halves. You will see a coloured vertical bar between the pictures

MENU

Call the PIP menu (PIP must be active, green frame)



Select "Type" and then "Split Screen".

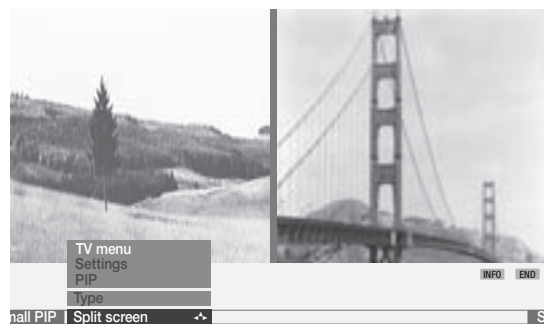

Operating modes – EPG

EPG - Programme guide

Note: The EPG does not work with DVB-T stations in UK. The "Now & Next" feature for programme info of the current and next broadcast is displayed instead.

EPG is an electronic programme guide. With this system, you can easily find the programmes that interest you (sorted according to day, time, channel and topic). You can mark programmes and programme recordings. Depending on whether you are receiving analogue stations by cable/antenna or digital stations, you will have different programme guides.

A wizard is activated the first time you use EPG (not with DVB) which guides you through the necessary settings. Then run the data capture (see next page).

Using the EPG

★ EPG Switch EPG on/off

The screenshot shows the EPG menu with settings for Date (Fri 10.09.), Time (now), Channels (all), and Topics (all). Below the settings is a programme list for Kabel 1, including 'Die Waltons', 'ARD-Buffer', 'Kinderkanal', 'ZDF heute - in Deutschland', 'Das Strafgericht', 'Zwei bei Kalwass', 'Das Geständnis - Heute s...', 'DAS! ab 2', 'Die kleinen Strolche (10)', and 'Familienserie - Sturzflug'. At the bottom, there are options for 'Detail', 'View', 'Record', 'Page', and 'select time'.

The programme guide menu is divided into two areas: at the top, you can make the settings for the programme list (date, ..., topics); on the bottom, the programme list is displayed. Use the **blue** coloured key to switch between the two areas to make your selections.

All programmes **currently** running are listed initially in the programme list. With the **▼ ▲** buttons, select the programme you want to watch and switch over with the **OK** button.

Brief information is shown below the programme list for some programmes. If more detailed information is available, you can call it using the **TEXT** button. Use **P+/P-** to scroll up or down through the pages of the programme guide. In the selection lines for date and time above, you will see the time change when scrolling; when you scroll further, the date also changes. When the "Time" line is selected, you can enter the time as of which the programmes are to be displayed; use the numeric buttons on your remote control to do this. Always enter four digits, such as 0900 for 9 a.m.

If programmes are displayed which have not yet started, you can mark these with the **OK** button. The TV set then switches automatically to this station at the given time. When receiving digital terrestrial and digital satellite stations, you may find that two identical EPG data are displayed in the "EPG (DVB)" menu for one station. If you call the EPG menu in the EPG mode by using the **MENU** button, then select "Station selection," you can select the duplicate station and deactivate it by using **OK**.

You have direct access to the selection lines above to pre-select the day, the time, the channel and the topic.



Blue coloured key: Call Select date/time/channels/topics

The screenshot shows the EPG menu with settings for Date (Sat 11.09.), Time (soon), Channels (all), and Topics (all). Below the settings is a programme list for Kabel 1, including 'Die Blobs', 'Wunderbare Jahre', 'Dennis', 'Extra en español (5)', 'Goal. Speak English. Play Football', 'Lokalzeit Südwestfalen', 'Reif für die Dodo-Insel (25)', and 'Reisetraum'. At the bottom, there are options for 'Change to programme list' and 'MENU'.

Use **▼ ▲** to select the menu line for the date, time, channels or topics. Use **◀ ▶** to select within the menu line.

If, for example, you are looking for the next news, select today's date, "Soon" under Time, "All" under Channels and "News" under Topics.

Then you get a list of all news programmes in the programme list below.

The screenshot shows the EPG menu with settings for Date (Fri 10.09.), Time (soon), Channels (all), and Topics (News). Below the settings is a programme list for Kabel 1, including 'Das Erste Tagesschau um drei', 'hr-fernse hessen aktuell', 'ZDF heute - Sport', 'SÜDWEST Baden-Württemberg Aktuell', and 'Das Erste Tagesschau um vier'. At the bottom, there are options for 'Change to programme list' and 'MENU'.

If you want to mark one of these news programmes, return to the programme list using the **blue** coloured key, select the desired news programme by using **▼ ▲** and mark this by using **OK**.

Operating modes – EPG

In front of the programme's title, the system places an . This station is switched later to this programme when the set is switched on. If the TV is off, it switches on again automatically at the beginning of the marked programme if this has been set in the EPG menu. If you are out, a security prompt prevents the TV set staying on unattended.

Before leaving the upper selection lines using the **blue** coloured key, select a specific line. If you have switched back to the programme list, you can change this menu line using **◀ ▶** without having to leave the programme list.

Programming recording for recorders

The programme marked using the **▼ ▲** buttons can be prepared for recording by pressing the **red** coloured key. In the following menu, confirm the timer data or change them as required. Then a red dot is set in front of this programme in the EPG programme list as an identification (if the timer data is being transferred to the recorder, no red dot is set). If you select this programme, you can delete it from the timer using the red coloured key (if the timer data has been transferred to a recorder, the timer has to be deleted there).

EPG menu



You will find the following settings in the EPG menu:

- Select provider
- Station selection
- Timer list
- Data capture
- Switch on TV when marked

Selecting providers and stations

If you want to change the provider for analogue TV reception (the station which transmits EPG data) to have other stations evaluated, you can do this under "Select provider".

Select "Select provider" and call this menu using **OK**. If the station you want to switch to is not listed in the "Select provider" list, then use the **yellow** coloured key to start the automatic search for stations with EPG data. This takes a while.

Or, if you know the station that transmits EPG data, press the **blue** coloured key to compile manually. Select the provider in the station list and adopt it by using **OK** and return to the provider selection using **◀◀**.

Select the provider in "Select provider" and adopt it using **OK**. Then a station list search is performed. The stations offered by the provider are displayed in a list.

If you want certain stations to be omitted from the programme guide, you can select and deactivate these via **Station selection**. Call the station selection by using the **blue** coloured key.

Now all stations are displayed (the DVB stations, too). Stations indicated with E are analogue terrestrial/cable stations; stations indicated with D are digital stations ready for the programme guide. Select the stations you want to omit from the programme guide one after another and deactivate each one by using **OK**.

Data capture

After these settings or after each time the set is switched off using the mains switch, the data must first be collected, before switching on the set.

To do this, select the station you have defined as a provider and leave the TV set switched on for about one hour or switch the set to the standby mode.

After about two minutes, the orange indicator on the set lights up. The data capture begins and lasts about 1 hour. The data are also automatically captured between 2 a.m. and 5 a.m. when the TV is switched to standby.

A prerequisite for data capture is that "Data capture" is "on" (for DVB + analogue) in the EPG menu.

Note: If the TV set is switched off using the mains switch or the mains plug is pulled out, all EPG data are lost.

If, for example, you cannot receive any analogue EPG providers or if you only use DVB, you should set the data capture to "on (only for DVB)".

Switch on TV when marked

You can have the TV switched on automatically from standby at the beginning of the marked programme. If you are not present at the time, a safety prompt makes sure the TV switches off again after 5 minutes.

Operating modes – Teletext

Analogue Teletext

Teletext transmits information such as news, weather, sports, programme previews and subtitles.

TEXT Teletext on/off



Many stations use the TOP operating system, some use FLOF (e.g. CNN). Your TV supports both these systems. The pages are divided into topic groups and topics. After switching on the teletext, up to 3,000 pages are stored for fast access.

Page selection with the coloured keys

The coloured bars (in TOP) or the coloured writing (in FLOF) in the next to the last line show you which coloured keys you can use to scroll to topic groups and topics.



Red: back to the previously seen page (not in FLOF)

Green: on to the next page (not in FLOF)

Yellow: to the next topic (only in TOP and FLOF)

Blue: to the next topic group (only in TOP and FLOF)

Other page selection options:



Select one page number specified on the page by using
 ▼ ▲ (Page Catching)

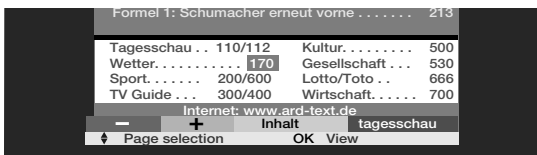

call.



In **Multiple pages** scroll using ◀ ▶. You can see which multiples pages can be called in the bottom menu line.



Call **contents page 100**



Call the **TOP table**

The TOP table is a general list of teletext. You can only call the table for stations that use the TOP operating system.

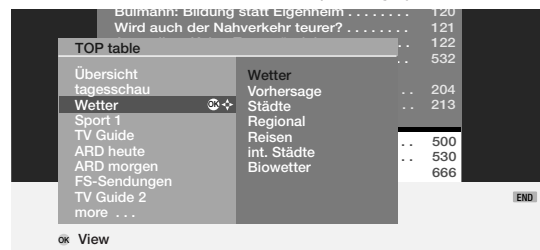

Use ▼ ▲ to select the topic group.

Select the topic column using ▶.

Select the topic with ▼ ▲ and display page with **OK**.

1 2 7 pgrs Enter the page number directly

Displaying teletext pages



Stop self-turning pages (HOLD)



Zoom page: top part - bottom part - normal size (press button several times)



TV picture on/off (Split Text)

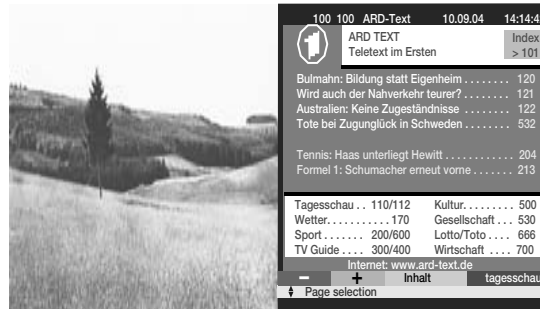

Operating modes – Teletext

Programme timer recordings

A video and/or DVD recorder must be connected and logged in in the connection wizard. Call the programme pages of the current station in teletext mode using the Direct recording button . Scroll to the teletext page in which the programme to be recorded is listed if necessary. Select the programme you want to record by with \blacktriangledown \blacktriangle and confirm with the **OK** button. For "Timer data," select the VCR or DVD recorder and whether you want to record once or a series of times. Confirm with **OK**.

Teletext menu

MENU

Display teletext menu



Here you will find functions such as

- "Newsflash", this is an on-screen display of the latest messages (e.g. page 111).
- "Reveal" concealed information, e.g. VPS pages in the station preview pages.
- Programme wizard for recording via teletext.

In the settings, you will find menus to define the station preview pages, subtitle pages and personal text pages, and menus to set the character set selection as well as HiText graphics.

Digital teletext operation (only for UK device version 27)

In the UK, the teletext for DVB-T stations is transmitted as per the MHEG-5 standard (standard of the Multimedia and Hypermedia Expert Group). It contains text, graphics, functions and links.

The operation of these menus depends on the particular provider. Normally after a station is changed, the provider broadcasting the digital teletext makes an introductory offer for this service on the screen via menu selection. Follow these notes.



Depending on the provider's respective offer, you can use the \blacktriangledown \blacktriangle \blacktriangleleft \blacktriangleright buttons and the **OK** button, the **coloured keys**, the **END/TEXT** button and sometimes even the **numeric buttons**.

If you want to close the digital teletext, just select a different station using the **P+ / P-** buttons or follow the menu prompts on the screen.

Note:

- Digital teletext is not available when DVB-subtitles are being displayed.
- If a timer recording is programmed at the TV-set, at the start time of the recording the digital teletext mode is switched off automatically

Operating modes – Radio

Radio

You can only receive radio stations via DVB. If you do not have any DVB radio reception, you can play a sound signal from an external device using the TV set via the sound/AV inputs.

RADIO

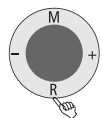

Use the **RADIO** button on the remote control or the **R** on the control ring of the TV set to switch the radio on or off.

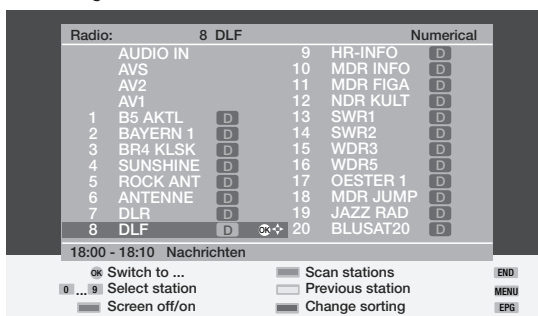

You can see a station list of the radio stations or with DVB-T in UK the station logo. In this case you can call up the station list by using the **OK** or **INFO** key. Station list is sorted by LCN.

If data are sent by the station, then the time and title of the programme are displayed in the station list.

When the station list is shown you can switch off the screen with the **red** colour key. The LED indicator on the set changes from green to orange. You can switch the screen display back on by using the **OK** key, **red** or **blue** colour keys, by using **RADIO** or **END** on the remote control or by using **R** on the control ring of the TV set.

Station switching with dark screen: by using **-** or **+** on the control ring of the TV set or by using the remote control **P-** and **P+** or by using the numeric buttons (for DVB-T operation in UK, the buttons may be configured differently by the provider).

The sound menu can be called in the radio mode using the  button.

Radio menu

MENU

Call radio menu



In the radio menu, as in TV mode, you can set the sound, search for radio stations and store them (automatically or manually – not with DVB-T mode in UK), delete stations from the list, rearrange them or change names and set the switching off and alarm functions.

EPG - Programme guide

Note: not with DVB-T stations in UK.

For the DVB radio stations, you can also use the programme guide if the station currently active supplies data.





*** EPG**

EPG- Call Programme guide

Operating additional equipment

Login and connect equipment

You have logged in and connected all connected equipment in the initial start-up. If you want to connect other equipment or disconnect equipment, call the connection wizard.

-  Call up the TV menu
-  Select "Connections"
-  Select the submenu line
-  Select "New devices/modifications" and ...
-  Call with OK.

State what equipment you want to connect. State whether a piece of audio equipment is to be connected (more details as of page 33). The connection wizard then shows you which sockets you should connect this equipment to. Then connect the equipment to these sockets according to the connection diagram.

Connecting video/DVD recorders

In addition to the connection via the Euro-AV sockets, you also have to connect the antenna (only for terrestrial antenna or cable systems) through the VCR/DVD recorder to the TV set. The antenna signal is then available to the video/DVD recorder and the TV set.

Note: Use Euro-AV cables with right-angled plugs as shown.

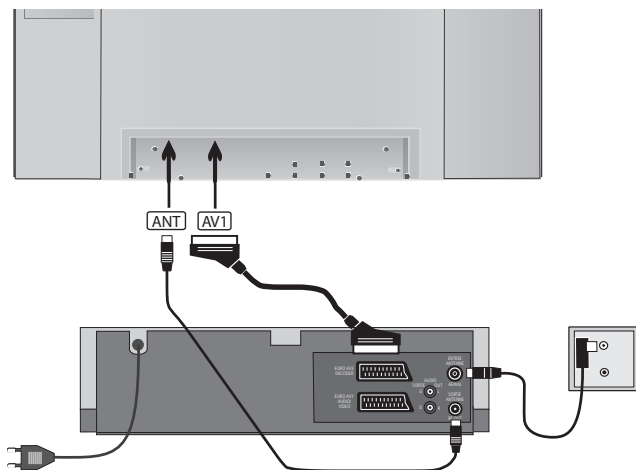

Search for and store the station of the video recorder (if no Euro-AV cable is available).

Switch on the test station on the VCR or insert a recorded tape and start playback. In some video recorders the station must be switched on by activating the modulator.

Then call the AV selection on the TV set with **0 AV**. Select the menu item "VIDEO" in the AV selection and call using **OK**.

To prevent "normal" TV stations being found in the search, pull out the antenna plug from the antenna input of the VCR temporarily (the cable to the antenna system).

If you cannot see the test station or playback from the cassette, the VCR is transmitting on a different channel. You then have to search for the station or set it manually.

1. Call the TV menu with the **MENU** button.
2. Select the "Settings" menu item with **◀ ▶**.
3. Select the line below using **▼** and use **◀ ▶** to select "Channels".
4. Select the line below using **▼** and select "Manual adjustment" using **◀ ▶** and call this menu using **OK**.
5. Enter channel "E30" under the "Channel" menu item ("Antenna/cable (analogue)", select in this menu above if necessary).
6. Start search with the blue coloured key.
7. When the station has been found, change the name if needed, confirm with **OK** and save with the **red** coloured key.
8. A list of the stored stations is displayed.
9. Select 0 (VIDEO) here and overwrite this station storage location using the **red** coloured key.
10. Hide the menu again using the **END** button.

Plug the antenna plug back in.

If you now get interference because a TV station is transmitting on the same channel as the VCR station, you have to change the transmitting station on the VCR and search for the VCR station on the TV again.

Operating additional equipment

Video playback

There are several ways to see the picture and hear the sound of the VCR, DVD player/recorder or camcorder on your TV:

1. You can usually use the Euro-AV sockets on the TV set and on the VCR. For camcorders or digital cameras, use the AVS sockets on the right of the TV set. DVD players/recorders and SetTopBoxes may have HDMI or component sockets for video and audio transmission. In this case, use the corresponding sockets on the TV set.

When playing back from a video recorder using Euro-AV socket and Digital Link Plus (or a comparable system from another manufacturer), the picture from the VCR is shown at the current channel location.

When playing back from another VCR, camcorder or digital camera, use the AV selection  or the station list (**OK**) to select the AV socket/the device to which the VCR is connected.

Video recorders transmit a switching voltage during playback, which the TV can evaluate (can be activated in the connection wizard or in the "TV menu – Connections – Miscellaneous – Allow switching voltage" - set to "yes"). Then the picture of the video recorder is shown during playback at the current station location.

2. You can use the antenna connection between the VCR and the TV without a Euro-AV socket. The sound is only transmitted in mono. Select the first menu item, e.g. VIDEO, in the AV selection.

Calling AV inputs in the AV selection:



Call AV selection



Select AV device/socket (or VIDEO if the video recorder has been connected only via the antenna socket) and use ...



to call.

Now you will see the playback from the connected AV device.

Calling AV input via the station list

Call the station list with the **OK** button in TV mode.

In the numeric and alphabetical sorting, you will always find the AV sockets at the top of the list.

Timer recording with video or DVD recorder

You can programme timer recordings on the TV set. Programming can be done with the EPG programme guide (not with DVB-T in UK), teletext or manually. Call the "Timer list" menu with the  button and press the **red** coloured key for the "Recording wizard". Select whether you want to programme the recording via EPG, teletext or manually. You also have the option to programme recordings directly from the EPG programme guide or teletext.

Note: Copy-protected programmes are not output to the Euro-AV sockets for legal reasons.

When you have connected the Euro-AV socket to a recorder which has **Digital Link Plus** or a comparable system from a different manufacturer, the timer data of analogue terrestrial stations are transmitted from the TV to the recorder. The recording quality SQ or EQ is transmitted for DVD recorders, in addition to the station, date and time. The recording is then controlled by the recorder and the recorder tuner is used for reception of the station. The recording data are not saved in the timer list of the TV set. You will only find the timer data in the recorder.

If you want to record from digital stations, the TV tuner is used and the recorder is controlled by the TV set. Then the station is locked during the timer recording.

If you have connected a Loewe video recorder with **Digital Link** to the Euro-AV socket (without Digital Link Plus) and you are using the timer programming of the TV, the TV receiver is always used, for terrestrial stations as well. The TV controls the recording.

You have to set the recorder to the AV input (signal source) to which the TV set is connected.

Then the station on the TV set is locked during the timer recording.

Digital Link must be switched on on the recorder. Read the operating instructions of your Loewe recorder for more information.

Use only Euro-AV cables, which are completely wired, otherwise Digital Link/Digital Link Plus will not work.

Another advantage of Digital Link is that you can install the recorder in a concealed place (e.g. in a rack). You can control the recorder with the TV set. If you have a Loewe recorder with both systems, you can use all the advantages. The advantages of Digital Link Plus are used for the timer recording; the advantages of Digital Link for concealed installation of the recorder.

Operating additional equipment

Assignment of digital audio inputs and outputs

Audio input "AUDIO DIGITAL IN"

The TV set has a coaxial digital audio input "AUDIO DIGITAL IN" and a coaxial digital audio output "AUDIO DIGITAL OUT". If you are using an external digital surround amplifier for sound reproduction, you have to feed digital audio signals to the TV, e.g. from the DVD player.

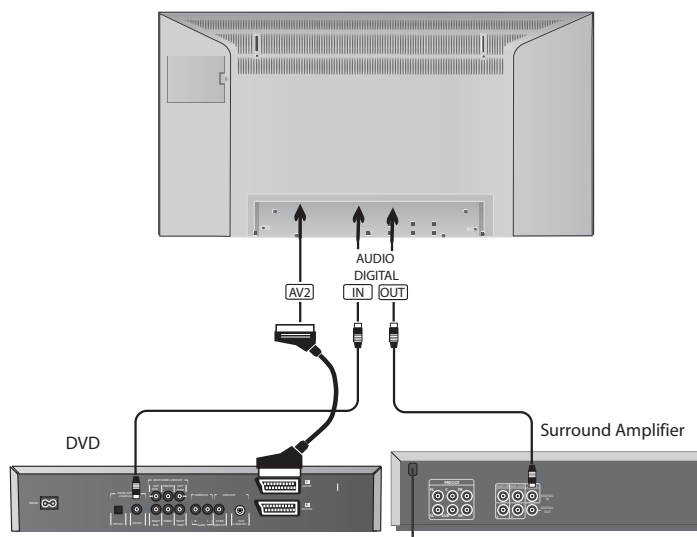

Connect the output socket of the DVD player (DIG OUT) to the TV's "AUDIO DIGITAL IN" socket with a cinch cable.

In the connection wizard, specify that audio transmission is to be digital. Specify that the digital sound is to be assigned for example to the Euro-AV socket 2 to feed the digital sound to the digital audio output of the TV set and via this to the external audio amplifier. Further information about this can be found on page 34.

Audio output "AUDIO DIGITAL OUT"

The digital audio signal is applied at the "AUDIO DIGITAL OUT" socket of the TV. For example, you can connect an external digital audio amplifier or the Loewe Auro system here.

An analogue audio signal from the TV set or another sound source which is received at one of the Euro-AV sockets of the TV set is converted into a digital signal (PCM) and output at the "AUDIO DIGITAL OUT" socket. Conversion from external analogue AV sources to PCM is not possible if the TV's loudspeakers are used as a centre channel. In this case, connect your audio amplifier additionally to the TV (AUDIO OUT L/R) with a cinch cable and switch the audio amplifier to analogue audio input.

The digital TV sound or the digital sound of a connected auxiliary device is only audible via an external digital audio amplifier (e.g. Loewe Auro system).

Operating additional equipment

Connecting Loewe DVD Preceiver Auro 2216 PS and Tremo loudspeaker system

You can play audio signals from the TV or DVD player in cinema quality with these components. The Tremo system includes 5 speakers for the front, centre and surround reproduction in addition to the subwoofer illustrated below. The centre signal can be reproduced alternatively by the TV speakers. Connect the cubic socket on the DVD Preceiver to the "Master" cubic socket on the subwoofer. Use the cubic plug cable enclosed with the DVD Preceiver. Plug the white plug (without kink protection) into the cubic socket on the subwoofer. For TV as a centre loudspeaker, connect "AUDIO IN C" on the TV set to "PRE OUT C" on the DVD Preceiver using a cinch cable.

Connect the digital audio output of the TV set "AUDIO DIGITAL OUT" to the "DIGITAL IN" input of the Preceiver using a cinch cable. Connect the TV socket "SERVICE" to the TV-L-Link socket on the Preceiver using the L-Link cable (provided with the Preceiver). Switch on the TV set and the Preceiver. Via the L-Link, the TV recognises whether the Preceiver is connected. Select the "Tremo" loudspeaker system in the DVD menu of the Preceiver, set the listener/speaker distances and adjust the speaker levels. Please consult the Preceiver manual.

If you want to listen to the sound via the TV speakers temporarily, call the Sound menu, select "Sound via" and then "TV". If you want to listen to the sound via the Loewe Auro system, select "AURO" under "Sound via".

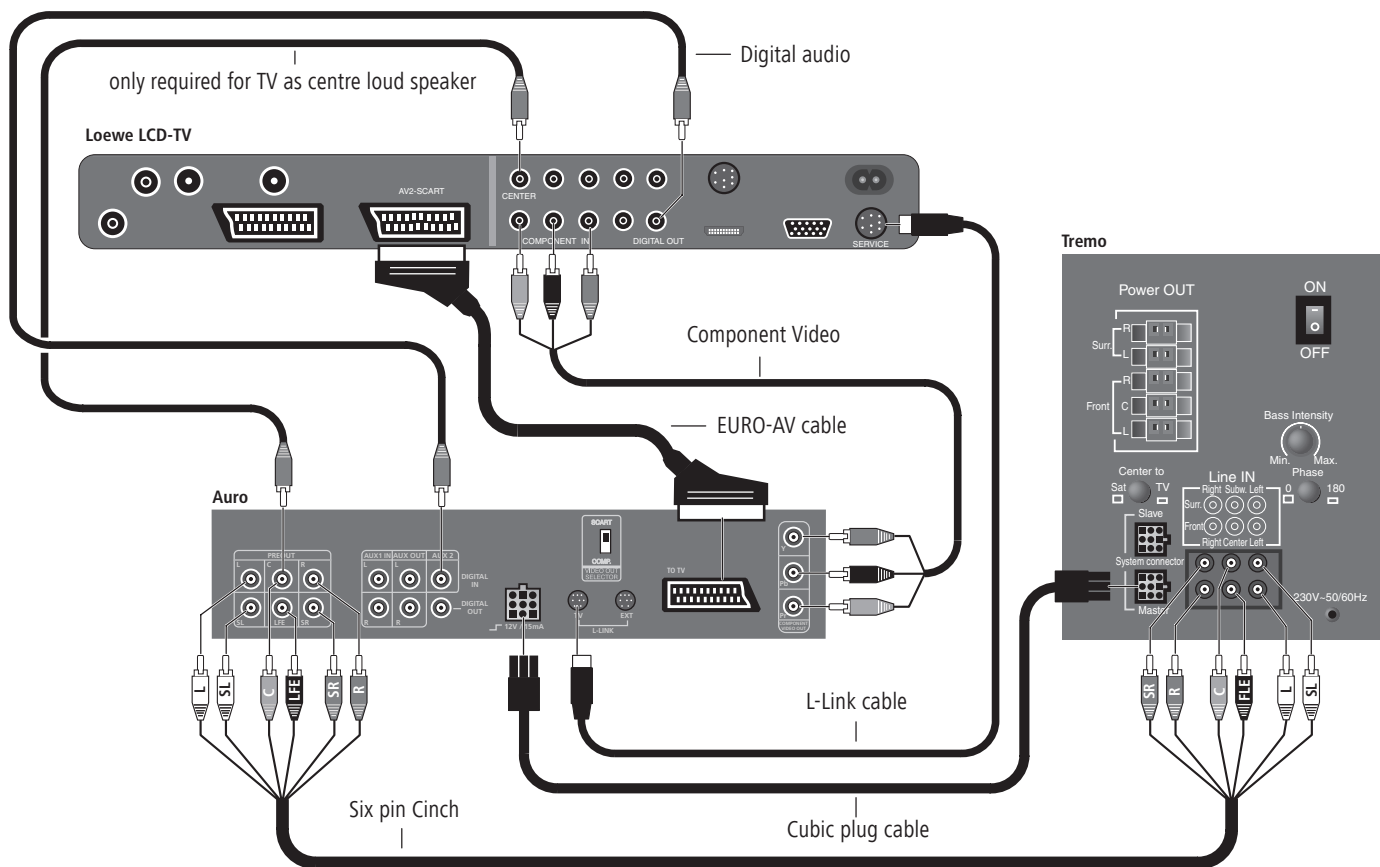

Operating additional equipment

Connecting other audio amplifiers or active speakers

In the connection wizard, select **"HiFi/AV amplifier"** under "Equipment selection: audio component". The connection wizard allows configuration of different audio amplifiers (stereo amplifiers, surround amplifiers, analogue or digital) with different sound formats (Dolby Digital, dts, MPEG and Stereo/PCM). Refer to the operating instructions for the audio amplifier to be connected.

Select **"Digital"** under "Audio transmission" for **digital audio amplifiers**. Connect the digital audio output of the TV AUDIO DIGITAL OUT to the digital audio input of the digital amplifier.

Assign the digital audio input to the socket through which the corresponding picture is transmitted (e.g. AV2 if a DVD player is connected there). Then the digital sound is passed to the digital audio output of the TV set and fed to the external audio amplifier via this.

Specify which sound formats can be decoded with your digital amplifier (Dolby Digital, MPEG, dts).

Specify under "Type of amplifier" whether the digital amplifier is a stereo or surround amplifier.

If it is a surround amplifier, specify whether or not the TV loudspeakers are to be used as centre loudspeakers. Connect the centre output of the amplifier to the centre output of the TV using a cinch cable, if necessary.

Note: do not use the centre loudspeaker connection on the amplifier; instead use the pre-amplifier centre output.

Select **"Analogue"** for "Sound transmission" for **analogue audio amplifiers**. The sound for the analogue amplifier is transmitted via the AUDIO OUT L/R connections of the TV to the audio amplifier. Connect the amplifier with two cinch cables.

Specify under "Type of amplifier" whether the analogue amplifier is a stereo or surround amplifier.

If it is a surround amplifier, also specify whether or not the TV speakers are to be used as centre loudspeakers. Connect the centre output of the amplifier to the centre output of the TV using a cinch cable, if necessary.

Note: do not use the centre loudspeaker connection on the amplifier; instead use the pre-amplifier centre output.

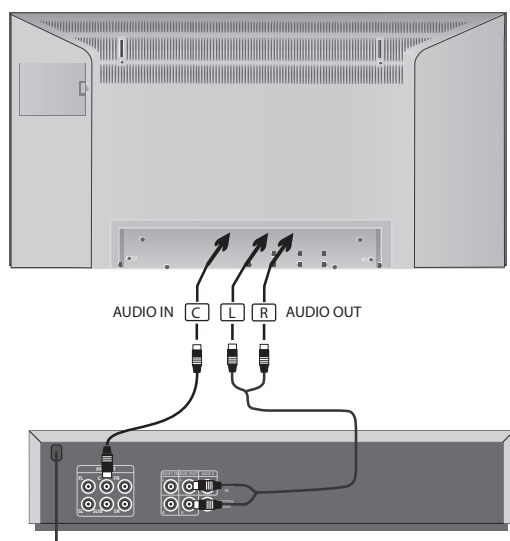
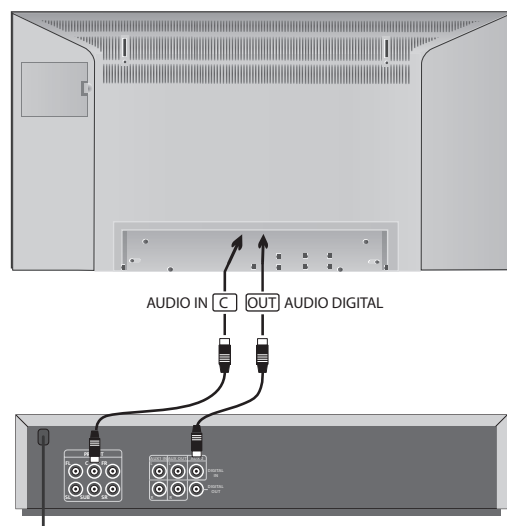

If you want to listen to the sound via the TV loudspeakers temporarily, call the Sound menu using the  button, select "Sound via" and then "TV".

When connecting **active speakers**, select "Active speakers" in the connection wizard under "Audio equipment selection". The sound for the active speakers is transmitted via the AUDIO OUT L/R connections to the active speakers. Make connections to the active speakers using the cinch cables. Make the audio settings on the TV set when active speakers are connected. When using an external audio amplifier, make the audio settings on the audio amplifier.

Operating additional equipment

HDMI (DVI) connection



The HDMI connection (High Definition Multimedia Interface) allows digital picture and sound transmission via a connecting cable, e.g. from Loewe DVD Recorder Centros 2102/2172 HD.

The digital picture and sound data are transmitted without data compression and therefore lose none of their quality. In the equipment connected, no analogue/digital conversion is necessary, which might also have lead to losses in quality.

DVI signals can be also be reproduced by the HDMI connection using a DVI/HDMI adapter cable. This is possible because HDMI is based on DVI and is downwardly compatible. That means that the digital video signals are transmitted via HDMI - no audio signals are transmitted, though. In addition, both use the same copy protection method HDCP.

Connect the set with an HDMI connection using an HDMI cable (type A, 19-pin) to the HDMI socket of the TV set. Log in the HDMI connection in the connection wizard (TV menu - Connections - New devices/modifications).

Select the HDMI connection in the AV selection.



Call AV selection



Select HDMI/DVI socket and use ...



to call.

Start playback on the device connected with HDMI connection.

The set automatically recognises and sets the best possible format for the video. If transmission occurs via a DVI/HDMI adapter cable, then you can feed in the appropriate analogue audio via the audio input sockets AUDIO IN L/R on the TV set. The sound is reproduced via the TV speakers.

If you have connected a digital external audio amplifier, you can select the digital audio signal in the connection wizard (TV menu - Connections - New devices/modifications) and assign it to the HDMI/DVI socket. You can make the other settings for the audio amplifier as described for digital amplifiers on page 34. The digital audio signal of the DVI audio source is fed in at the AUDIO DIGITAL IN socket on the TV. Feed the digital audio signal from the TV AUDIO DIGITAL OUT to the external amplifier.

Set geometry: as described for the VGA/XGA connection

VGA/XGA connection



You can connect a PC or a Set Top Box (STB) and therefore use the TV screen as an output device.

Connect the PC/STB to the VGA/XGA socket on the TV using a VGA cable.

When connecting to a PC, first set one of the following screen resolutions on your PC.

800x600 60Hz (SVGA)

1024x768 60Hz (XGA).

When a Set Top Box is connected, set the following screen resolutions according to the options of the Set Top Box:

720x576i (PAL), 720x480i (NTSC), 720x480p (60 Hz)

720x480i, 720x 576i (SDTV – standard modi for STB) 720x576p (50 Hz)

1280x720p, 1920x1080i (HDTV modi)

Select the VGA/XGA connection in the AV selection.



Call AV selection



Select VGA socket and use ...



to call.

Start the connected device.

Set geometry

Call the TV menu using the **MENU** button, select "Geometry" using ◀ ▶ and set:

If the picture is not positioned correctly, you can move the picture horizontally and vertically here so that it fills the whole screen. You can also set the phase position so that the picture appears in the best possible quality.

Setting colour standard

Call the Picture menu using the  button. Select "Colour standard" using ◀ ▶ and make your selection.

The colour standard for a connected PC is RGB.

In Set Top Boxes, you usually set Ycc as a colour standard. Other formats such as Ypp or RGB can also be output. Please consult the operating instructions of the device connected.

If the wrong standard is selected, you will recognise this by the wrong colours in the display.

Operating additional equipment

Sound from PC or Set Top Box

Feed the analogue audio signal from the PC or the STB to the sockets AUDIO IN L/R on the TV via a cinch cable. The sound is reproduced via the TV speakers. If you have connected a digital external audio amplifier, you can select the digital audio signal in the connection wizard (TV menu - Connections - New devices/modifications) and assign it to the VGA/XGA socket. You can make the other settings for the audio amplifier as described for digital amplifiers on page 34. The digital audio signal of the Set Top Box is fed in at the AUDIO DIGITAL IN socket on the TV. Feed the digital audio signal from the TV AUDIO DIGITAL OUT to the amplifier.

Component video connection



If you have a DVD player/recorder with Component OUT connections, you can connect it to the SD/HD-COMPONENT IN sockets of the TV instead of to the Euro-AV sockets. The connecting cable with three cinch plugs each transmits picture information. The playback is of a better quality than via the Euro-AV socket. You need another cinch cable for the analogue sound transmission. Connect the analogue audio outputs of the DVD player to the AUDIO IN L/R sockets on the TV set. The sound is reproduced via the TV speakers.

If you want to use the digital sound of the DVD player with a digital audio amplifier connected to the TV, make a connection between AUDIO DIG OUT of the DVD player and AUDIO DIGITAL IN of the TV set.

Log in the component/device in the connection wizard:

Assign the AUDIO DIG IN input here to the COMP. IN socket, provided a digital audio amplifier is also connected. You can make the other settings for the audio amplifier as described for digital amplifiers on page 34.

Set the signal at the component input in the connection wizard: Set to "Automatic" first. If the signal is not reproduced when playback is started, consult the operating instructions of the DVD device connected to find out what screen resolution is possible (SDTV, HDTV or ProScan).

Select the component connection in the AV selection.



Call AV selection



Select COMP. IN sockets and use ...



to call.

Start playback on the connected device.

Set geometry and colour standard: as described for the VGA/XGA connection.

Operating additional equipment

Operating other Loewe devices with the RC3 remote control

Using this remote control, you can operate additional devices from Loewe.

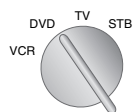

Use the rotary switch to select VCR, TV or a Set Top Box.

The following are preset at the factory: Loewe VCRs, Loewe TV sets and for STBs (Set Top Box) in Germany, the common d-box.

Use the driver buttons in the TV and STB position for VCR, DVD or Digital Recorder.

You can switch over the six drive buttons

(), both for the TV and for the STB, to control a VCR or DVD player/recorder (the control of the integrated "Digital Recorder Plus" is preset at the factory):

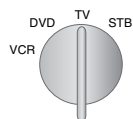

First set the switch to the main function TV or STB.



Then press the **END** and *** EPG** buttons simultaneously for at least 5 seconds. The upper left indicator on the remote control will blink twice.

9 wxyz

8 tuv

8 tuv

Enter the the numbers 988 in sequence. The indicator will again blink two times.

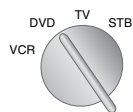

Now set the switch to the desired function for the drive buttons: to DVD, VCR or to TV, if the digital recorder is to be operated.

Press the **# PIP** button to complete the setting. The indicator will blink two times.

PIP

Setting the remote control to operate devices from other manufacturers

You can switch over the remote control for other VCRs, DVD players and Set Top Boxes if the infrared code for the device type is listed in the code list or if it is included in the code memory of the RC3.

Even if the manufacturer of the device is listed in the code list, it may not be possible to operate that device using the Loewe remote control.

Setting the remote control using code entry

Search for the code number for your device in the code list (see as of pages 46-50). The list is arranged according to device type – DVD, VCR, STB – and alphabetically according to manufacturer. Next to the manufacturer's name, you will find one or more code numbers.

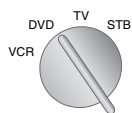

Use the rotary switch if you want to switch over a VCR, DVD device or a Set Top Box.



0 AV

5 jkl

3 def

9 wxyz

Press the **END** and *** EPG** buttons simultaneously for at least 5 seconds. The upper left indicator on the remote control will blink twice.

Enter the four numbers in sequence that you found in the code list (e.g. 0539 for Loewe DVD player).

After each number you enter, the indicator will blink once, after the last number it will blink twice. If the number was incorrect, the indicator will remain lit longer. The code number was not accepted. If the code was accepted with two blinks, you can test the functions of the device you just programmed.

If the device cannot be operated or can only be operated poorly, repeat the code entry with the next code from the list. If there are no other codes specified for this manufacturer, try it using the code suggestions from the remote control.

Setting the remote control using the suggestions from the remote control

Switch the device **on** that you want to switch over to the remote control. Standby mode is not enough.

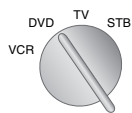

Use the rotary switch if you want to switch over a VCR, DVD device or a Set Top Box.



9 wxyz

9 wxyz

1

PIP

Press the **END** and *** EPG** buttons simultaneously for at least 5 seconds. The upper left indicator on the remote control will blink twice.

Enter the the numbers 991 in sequence. The indicator will blink once after each number entered.

Press the **# PIP** button to select the first code.

Point the remote control toward the device you want to switch over to the remote control. Observe that device.



Now press the button (Play) or **On/Off** on the remote control.

Wait a moment for the device to react. If the device does not react, then that was not the right code. Press the **# PIP** button again to call the next code.

PIP



Press the button (Play) or **On/Off** again.

* EPG

If the device reacts, press the *** EPG** button to adopt the code.

Operating additional equipment

Using the RC3 remote control to operate a DVD recorder or DVD player

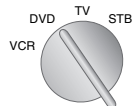

Set the rotary switch to "DVD".

The infrared code and the functions are preset at the factory for the Loewe DVD recorder Centros 21x2 HD.

In the DVD mode, it is possible to operate the Loewe DVD recorders Centros 1102, 1172, 2102HD, 2172HD, and the DVD players Xemix 6122DO, 8122DA and 6222PS.

Functions for the Loewe DVD recorders (Centros 1102, 1172, 2102, 2172)

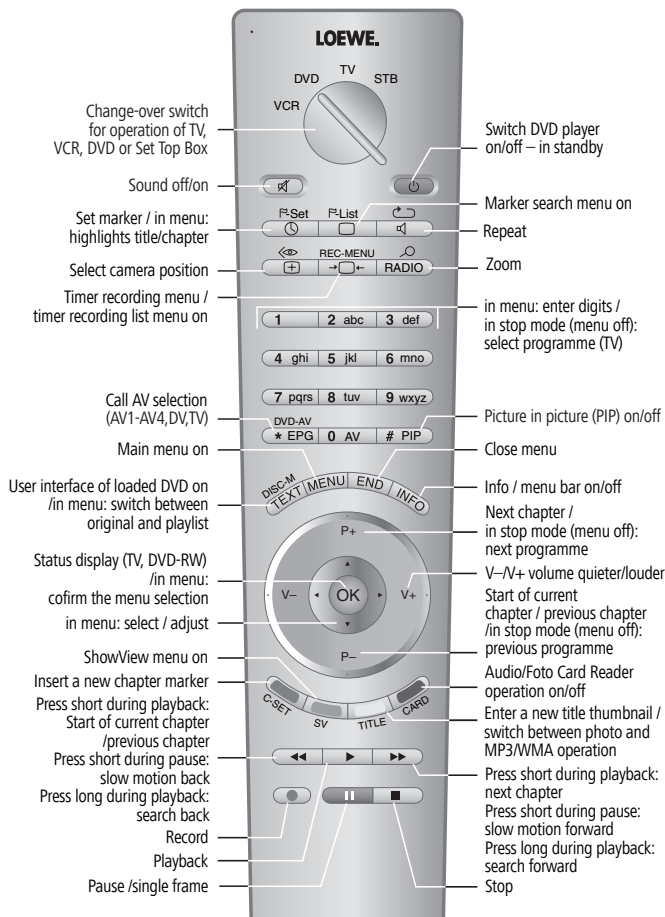

Using the RC3 remote control to operate a VCR

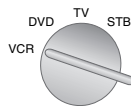

Set the rotary switch to "VCR".

The infrared code and the functions for a Loewe VCR are preset at the factory.

In VCR mode, the following VCRs can be operated: ViewVision 8106H, 8136H, 8176H, 6306H, 6336H, 6376H, 6396H, 4306H, 4376H, 2102M, 2302M, 4206, 4236, 4276.

For other Loewe equipment than that listed, please use the original remote control.

Functions for Loewe VCR (VV 8106, 8136, 8176)

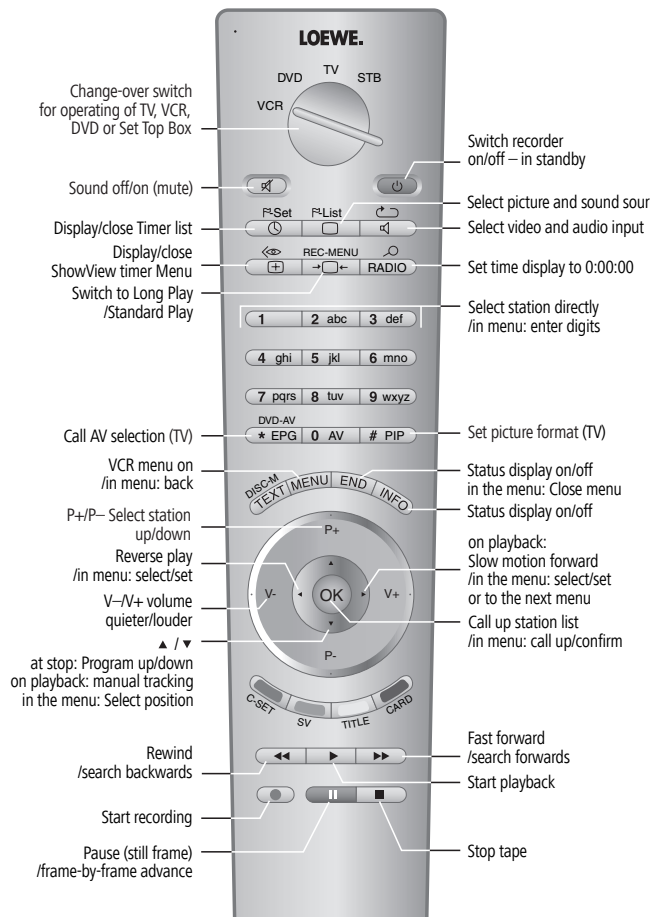

Operating additional equipment

Rotating the TV set

Individual / Individual Selection sets have a connection for a rotating stand control.

If the TV set is mounted on a motor unit, you can use the remote control to adjust it to your seating location accordingly.

You can fix the position of the TV set when the set is switched off.



Rotate the TV set when no menu or PIP is being displayed.

Note: Make sure there are no objects in the TV's area of rotation that might obstruct the rotation or be knocked down due to the rotating motion.

Setting the position of the TV set when switched off

You can set the position the TV set is to assume once it is switched off (switch-off position must be activated for this):

MENU

Call up the TV menu

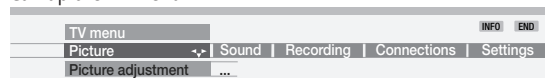

Select "Settings"



under that, select "Miscellaneous"



under that, select "Rotate TV"

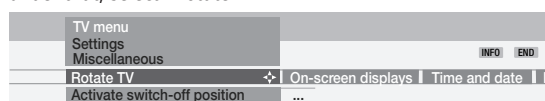

under that, select "Activate switch-off position"



under that, select "yes"



go up and select "Set switch-off position"



use OK to go down and use the ◀ ▶ arrow buttons to set the desired switch-off position. The TV set rotates in the process.



use OK to save the position set.

END

Close the menu

If the TV set is switched off using the blue on/off button on the remote control, the set will rotate to the position defined.

When it is switched back on, it returns to the position last set manually.

What to do, if ...

Problem	Possible cause	Remedy
The "Recording" menu point is not displayed in the TV menu.	No video or DVD recorder logged in.	Log in the video or DVD recorder in the connection wizard and connect the device.
"Connections" cannot be called in the TV menu (deactivated)	A time recording is in progress.	Wait until the timer recording has ended or delete the timer.
The control of the Loewe video recorder and the timer do not work or do not work properly.	<ul style="list-style-type: none"> a) The Digital Link function is not activated or not possible in the recorder. b) Euro-AV cable is not connected. c) Recorder is not logged in. 	<ul style="list-style-type: none"> a) Activate Digital Link in the recorder (see operating instructions of the video recorder). b) Connect the Euro-AV cable. c) Log in recorder.
General problems with connecting external equipment via an AV input.	<ul style="list-style-type: none"> a) The device is not logged in to the connection wizard or is connected differently than is shown in the connection diagram. b) The AV norm is set incorrectly. c) The AV signal is set incorrectly. 	<ul style="list-style-type: none"> a) In the connection wizard (TV menu – Connections – New devices/modifications), compare the connection diagram with the actual installation and connect as shown, if necessary. b) Set the norm correctly. c) Set the AV signal correctly. <p>If "Automatic" is set for AV norm or AV signal, this can lead to errors for signals which do not conform to the norm. Then the norm and the signal are to be set according to the specifications in the operating instructions of the external device.</p>
A decoder connection does not function or is faulty.	<ul style="list-style-type: none"> a) The signal is not decoded because the wrong decoder stations are selected in the connection wizard. b) The sound is missing in decoder mode because the wrong decoder sound is assigned in the connection wizard. 	<ul style="list-style-type: none"> a) Follow the instructions in the connection wizard again (TV menu – Connections – New devices/modifications) and select the corresponding decoder station. b) Follow the instructions in the connection wizard again and select the right audio source (decoder, TV or autom.), see instructions of the decoder.
All menus appear in the wrong language.	Menu language has been set incorrectly.	Set your menu language: Press the INFO button in TV mode (index). Select the first index item and call it by using OK . Then select the language and confirm with OK .

What to do, if ...

Problem	Possible cause	Remedy
Digital Link Plus does not function.	<ul style="list-style-type: none"> a) Euro-AV cable is not fully wired (pin 10 not wired). b) Some recorders can only adopt stations during the initial installation of the TV set. c) All or some of the terrestrial and cable stations are stored on station storage locations ≥ 99. 	<ul style="list-style-type: none"> a) Replace the Euro-AV cable. b) Restore the recorder to the as-delivered state (see recorder's operating instructions). c) Rearrange the terrestrial and cable stations so that they fall between 1 and 99.
Various characters are displayed incorrectly in the teletext.	The wrong character set is set in the teletext menu.	Set the right character set: Teletext menu - Settings - Character set: standard or the appropriate character set.
No sound via external digital audio amplifier.	<ul style="list-style-type: none"> a) The external digital audio amplifier does not support the selected sound format (Dolby Digital, dts, MPEG). b) TV set and external digital audio amplifier are not connected. 	<ul style="list-style-type: none"> a) Set PCM stereo on the DVD player in the sound selection. For DVB stations, switch language/ sound selection (green coloured key) to Stereo on the TV set in the status display (END). b) Connect Digital-Out from the TV set to a Digital-In of the external digital audio amplifier and select the appropriate input to this.
Device on mounted motor unit does not rotate.	Motor unit and connection for rotating stand control are not connected to each other.	Use related cable to connect socket of motor unit to interface of rotating stand control (see assembly instructions for motor unit).

Technical data

General data

Type	Individual 26	Individual 26 Selection	Individual 32	Individual 32 Selection
Versions DVB-T/C	-	-	65404x89	65414x89
Versions DVB-T CI	-	65412x27	65404x27	65414x27
Versions DVB-T/C CI	65403x87	65412x87	-	-
Versions DR+ DVB-T/C CI	-	-	-	65414x47
Set dimensions without stand (ca. cm WxHxD)	67,4x50,3x11,0	67,4x50,3x11,0	81,5x57,9x9,9	81,5x57,9x9,9
Dimensions with stand (ca. cm WxHxD)	67,4x56,0x32,0	67,4x56,0x32,0	81,5x62,8x32,0	81,5x62,8x32,0
Set weight without stand (ca. kg)	14,0	18,0	18,0	22,4
Set weight with stand (ca. kg)	19,0	23,0	23,0	27,4
Display	HD-LCD technology	HD-LCD technology	HD-LCD technology	HD-LCD technology
Picture diagonal (cm)/picture format	66/16:9	66/16:9	80/16:9	80/16:9
Resolution	1366x768	1366x768	1366x768	1366x768
Contrast ratio	800:1	800:1	800:1	800:1
Angle of viewing horizontally/vertically	170°	170°	170°	170°
Power consumption (IEC 62087)				
in operation (watt)	70	70	85	85/100
in standby (watt)	< 3	< 3	< 3	< 3
Ambient temperature (Celsius)	5° – 35°			
Relative humidity (not condensing)	20 – 80%			
Barometric pressure	800 – 1114 hPa (0 – 2000 m over NN)			

 The code number 3001 cancels out a secret code and with it the child lock. Please keep in a safe place.

Technical data

Electrical data

Chassis name	L 2650
Power supply	220 V -240V/50- 60 Hz
Tuner VHF/UHF/ cable	
Hyperband 8 MHz	41 MHz to 860 MHz
Station storage locations	430 / for DVB 1680
TV standards	B/G, I, L, D/K, M, N
Colour standard	SECAM, PAL, NTSC, NTSC-V, PAL-V (60Hz)
Sound standard	Mono/Stereo/Dual-channel Nicam B/G, I, L, Virtual Dolby
Rated audio power	2 x 20 watt
Analogue Teletext	TOP/FLOF Level 2.5
Page Memory	3000
Digital Teletext (in UK only)	MHEG-5

Connections

Jack 3.5mm	Headphones 32- 2000 ohm
Mini-DIN (AVS) Video IN	Y/C (S-VHS/Hi 8)
Cinch (yellow) Video IN	CVBS (VHS/8 mm)
Cinch (white/red) Audio IN	L/R
IEC socket 75 Ohm/5 V/80 mA	Antenna/cable/analogue PIP ⁽¹⁾ /DVB-T/C
F socket 75 Ohm 13/18 V/350 mA ⁽²⁾	ANT-SAT
EURO-AV 1 Video IN	Y/C (S-VHS/Hi 8)
	CVBS (VHS/8 mm)
	CVBS (VHS/8 mm)
	Y/C (S-VHS/Hi 8)
	L/R
	L/R
EURO-AV 2 Video IN	Y/C (S-VHS/Hi 8)
	CVBS (VHS/8 mm)
	RGB, YUV
	CVBS
	Y/C, (only with SVHS Link Plus)
	L/R
	L/R
Cinch Audio IN max. 2Vrms	Centre
2 x Cinch Audio IN	L/R
2 x Cinch Audio OUT (level adjustable in active loud speakers)	L/R
Cinch COMPONENT IN:	Cb/Pb signal
Cinch COMPONENT IN:	Cr/Pr signal
Cinch COMPONENT IN:	Y signal
Cinch Digital Audio IN (SPDIF)	Digital audio
Cinch Digital Audio OUT (SPDIF)	Digital audio
HDMI/DVI Digital Video/Audio IN type A 19pin	Digital video and audio
VGA/XGA VGA/XGA IN	PC/STB video signal
Mini-DIN	Service/L-Link

⁽¹⁾ PIP tuner can be retrofitted for Individual 32 DVB-T/C and Individual 32 Selection DVB-T/C.

⁽²⁾ Digital satellite tuner can be retrofitted,
Twin sat tuner can be retrofitted for sets with digital recorder.



Dolby and the double 'D' symbol are trademarks of Dolby Laboratories

Printed in Germany
TB/05/10/1.1
Subject to modifications!
© by Loewe Opta 2005

Accessories

Wall holders and stands

Refer to the notes on the installations options on page 6.

PIP tuner

The PIP tuner enables picture in picture displays (PIP) for analogue terrestrial and cable reception.

You can retrofit either this PIP tuner or a digital satellite tuner.

The PIP function is possible with both retrofit versions.

Retrofit not possible for Individual 26 / Individual 26 Selection and UK sets.

Loewe order no. 89442.080

Digital Satellite Tuner

You can have your TV set retrofitted with the digital satellite tuner. You receive DVB-S stations with this tuner.

The digital satellite tuner is completely integrated in the TV set (physically and logically) and is operated by the remote control/menu control of the TV.

When you retrofit your TV set with the digital satellite tuner, your TV set automatically has the PIP function.

You can retrofit either this digital satellite tuner or a PIP tuner.

Retrofit not possible for UK device versions.

Loewe order no. 89361.055

DVB-S Twin sat tuner

(only for sets with a Digital Recorder)

If your TV set is equipped with the Digital Recorder+, you can have it retrofitted with an integrated DVB-S twin sat tuner.

The integrated PIP DVB-T/C tuner is exchanged for the DVB-S twin sat tuner.

Loewe order no. 89443.080

Common interface (CI)

(can only be retrofitted for Individual 32 DVB-T/C and Individual 32 Selection DVB-T/C)

The common interface (slot for CI module) enables you to also receive encrypted stations.

You can purchase the CI module and smartcard at your specialist dealer.

Loewe order no. 89346.080

Inlays

For your Individual / Individual Selection set, there is the possibility to exchange the inlays (covers) attached at the sides to match the décor of your home.

There are different surface textures or colours to choose from for the inlays for your Individual / Individual Selection set.

Please contact your specialist dealer to find out more about this offer.

Wooden trims are a natural product. UV light (exposure to strong sunlight) can cause slight discoloration here.

Loewe Video Recorders

Loewe video recorders are specially adapted to Loewe TV sets in design, user guidance and technical properties. They greatly simplify daily handling of the equipment.

Loewe DVD players and recorders

The DVD players and recorders from Loewe are characterised by form and colour, which match Loewe TV sets, adapted user guidance and technology. A combination of the two devices forms a system which offers many advantages.

Loewe audio system Auro and the active speaker system Tremo

The interplay of a Loewe TV with a Loewe audio system and a Loewe speaker system creates an excellently coordinated home cinema system. Advantages are high operating comfort, attractive design and adapted technology.

Subject to delivery options.

Service Addresses

Australia

International Dynamics Australasia Pty Ltd.
129 Palmer Street
AUS - Richmond, Victoria 3121
Tel. 00 61 - 3-94 29 08 22
Fax 00 61 - 3- 94 29 08 33
Email ekyriakides@internationaldynamics.com.au

BeNeLux

Loewe Opta Benelux NV/SA
Uilenbaan 84
B-2160 Antwerpen
Tel. 00 32 - 3- 2 70 99 30
Fax 00 32 - 3- 2 71 01 08
Email ccc@loewe.be

Denmark

Kjaerulff 1 A/S
C.F.Tietgens Boulevard 19
DK-5220 Odense SØ
Tel. 00 45 - 66 13 54 80
Fax 00 45 - 66 13 54 10
Email mail@kjaerulff1.com

Germany

Loewe Opta GmbH, Customer Care Center
Industriestraße 11
D-96317 Kronach
Tel. 0049 1801-22256393
Fax 0049 9261-99500
Email ccc@loewe.de

France

Loewe France S.A.
13 rue du Dépôt, Parc del l'Europe, BP 10010
F - 67014 Strasbourg Cédex
Tel. 00 33 - 3- 88 79 72 50
Fax 00 33 - 3- 88 79 72 59
Email loewe.france@wanadoo.fr

Greece

SOUND HELLAS S.A.
Kleanthous Str. 10
GR-54642 Thessaloniki
Tel. 00 30 - 2310 - 856 100
Fax 00 30 - 2310 - 856 300
Email sound@spark.net.gr

Great Britain

LinnSight Ltd.
PO Box 8465
UK - KA 7 2YF Prestwick
Tel. 00 44 - 12 92 - 47 15 57
Fax 00 44 - 12 92 - 47 15 54
Email helpline@linnsight.co.uk

CIS

Service Center Loewe
Petrovsky per., d. 5, str. 3 of. 17
RUS-107031 Moscow
Tel. 0 95 - 928 33 58
Fax 0 95 - 928 58 79
Email loewerus@online.ru

Israel

PL Trading (pz 2004) Ltd.
27, Aliat Hanoar St.

ISR - Givataim 53401
Tel. 00 972 - 3 - 57 27 155
Fax 00 972 - 3 - 57 27 150
Email zeev@loewe.co.il

Italy

Loewe Italiana SRL
Lago del Perlar, 12
I-37135 Verona
Tel. 00 39 - 045 82 51 611
Fax 00 39 - 045 82 51 622
Email Edoardo.Bricchi@loewe.it

Malta

Mirage Holdings Ltd
Flamingo Complex, Cannon Road
M-Qormi
Tel. 0 03 56 22 - 79 40 00
Fax 0 03 56 21 - 44 59 83
Email s.martinelli@flamingo.com.mt

Morokko

SOMARA S.A.
377, Rue Mustapha El Maani
MA-20000 Casablanca
Tel. 00 21 22 - 2 22 03 08
Fax 00 21 22 - 2 26 00 06
Email somara@wanadooopro.ma

Norway

CableCom AS
Østre Kullerød 5
N-3214 Sandefjord
Tel. 00 47 - 33 48 33 48
Fax 00 47 - 33 44 60 44
Email roy@cablecom.no

Austria

Loewe Austria GmbH
Parkring 10
A-1010 Wien
Tel. 00 43 1 / 51 633 - 31 34
Fax 00 43 1 / 51 633 - 30 32

Poland

DSV TRADING SA
Plac Kaszubski 8
PL-81-350 Gdynia
Tel. 00 48 58 - 6 61 28 00
Fax 00 48 58 - 6 61 44 70
Email market@dsv.com.pl

Portugal

Videoacustica
Comercio e Representacoes de
Equipamentos Electronicos S.A.
Estrada Circunvalacao, Quinta do Paizinho, Arm. 5
P-2795-632 Carnaxide
Tel. 0 03 51 - 2 14 24 17 70
Fax 0 03 51 - 2 14 18 80 93
Email office@videoacustica.pt

Sweden

Kjaerulff 1 AB
Ridbanegatan 4, Box 9076
S-200 39 Malmö
Tel. 00 46 - 4 06 79 74 00

Fax 00 46 - 4 06 79 74 01

Switzerland

Telion AG
Rütistrasse 26
CH-8952 Schlieren
Tel. 00 41 - 44 732 15 11
Fax 00 41 - 44 730 15 02
Email infoCE@telion.ch

Slovenia

Jadran Trgovsko Podjetje
Partizanska cesta 69
SL-6210 Sezana
Tel. 0 03 86 - 57 31 04 40
Fax 0 03 86 - 57 31 04 42
Email milos.zvanut@jadran.si

Spain/Canary Islands

Gaplasa S.A.
Conde de Torroja, 25
E-28022 Madrid
Tel. 0 03 49 - 17 48 29 60
Fax 0 03 49 - 13 29 16 75
Email loewe@maygap.com

South Africa

THE SOUNDLAB PTY LTD
P.O. Box 31952, Kyalami 1684
Republic of South Africa
Tel. 00 27 - 1 14 66 47 00
Fax 00 27 - 1 14 66 42 85
Email loewe@mad.co.za

Czech Republic

K+B EXPERT SPOL. S R.O.
U Expertu 91
CZ - 25069 Klicany u Prahy
Tel: 0 04 20 - 2 72 12 21 11 (222)
Fax: 0 04 20 - 2 72 12 21 99 (239)
Email loewe@kbexpert.cz

Turkey

Enkay Elektronik Servis Müdürlüğü
Alemdag Cad: Site Yolu No.: 10
Ümraniye/ Istanbul
Tel. 00 90 - 216 634 44 44
Fax 00 90 - 216 643 39 88
Email mhatipog@enkaygroup.com

Hungary

Basys Magyarorszagi KFT
Epitok utja 2-4
H-2040 Budaörs
Tel. 00 36 - 23 41 56 37 (121)
Fax 00 36 - 23 41 51 82
Email basys@mail.nasys.hu

Cyprus

HADJIKYRIAKOS & SONS LTD.
Prodromou 121, P.O Box 21587
CY-1511 Nicosia, Cyprus
Tel. 0 03 57 - 22 87 21 11
Fax 0 03 57 - 22 66 33 91
Email savvas@hadjikyriakos.com.cy

Codelist RC3 / Lista de códigos RC3

Loewe

DVD-Player 0539
 DVD-Recorder Centros 11x2 0741
 DVD-Recorder Centros 21x2 1463
 STB 1127
 VCR 0866

DVD

3DLAB 0539
 A-Trend 0714
 Acoustic Solutions 0730
 AEG 0788 0770
 Aiwa 0641 0695
 Akai 0790 0788 0690 0716 0713 0705
 AKI 0718
 Akira 0699
 Alba 0717 0699 0713 0723 0695
 All-Tel 0790
 Amitech 0770
 Amstrad 0713
 Apex Digital 0672
 Audiosonic 0690
 AWA 0730
 Black Diamond 0713
 Blaupunkt 0717
 Blue Sky 0699 0695 0713 0672 0651
 Boman 0783
 Brain Wave 0770
 Brandt 0651 0551
 Bush 0699 0690 0689 0717
 0713 0818 0695 0831 0723
 C-Tech 0768
 Cambridge Audio 0696
 Cambridge Soundworks 0696
 CAT 0699
 Celestial 0672
 Centrex 0672 1004
 Centrum 0713
 cineULTRA 0699
 Classic 0730
 Clatronic 0788
 Clayton 0713
 Coby 0730
 Conia 0672
 Crown 0770 0651 0690
 Cybercom 0831
 CyberHome 0714 0816
 Cytron 0716 0651 0705
 Daewoo 0770 0705 0714
 Daewoo International 0699
 Dansai 0770 0783
 Dantax 0723

DEC 0699 0818
 Decca 0770
 Denon 0490 0634
 Denver 0699 0788
 Denzel 0665
 Diamond 0651 0768 0723
 Digihome 0713
 digiRED 0717
 Digitrex 0672
 DiK 0831
 Dinamic 0788
 DiViDo 0705
 DK digital 0831
 DMTECH 0783 0790
 Dragon 0831
 Dual 0665 0651 0713 0730
 0783 0790 0831
 E-Boda 0723
 Eclipse 0723
 Electrohome 0770
 Elin 0770
 Elta 0690 0770 0788 0790
 Emerson 0591 0705
 Enzer 0665
 Ferguson 0651
 Finlux 0741 0770 0783
 Firstline 0651
 Funai 0695
 GE 0717
 Global Solutions 0768
 Global Sphere 0768
 Go Video 0783
 GoldStar 0591 0741
 Goodmans 0651 1004 0790 0690
 0783 0723 0818
 Graetz 0665
 Grandin 0716
 Grundig 0539 0695 0651 0775
 0705 0790 0713 0670 0723
 Grunkel 0770
 H&B 0818 0713
 Haaz 0768
 Hanseatic 0741
 HCM 0788
 HDT 0705
 HE 0730
 Henß 0713
 Hitachi 0664 0665 0573
 Hiteker 0672
 Home Electronics 0730
 Hyundai 0783
 Ingelen 0788
 ISP 0695
 Jeken 0699
 JMB 0695
 JVC 0623 0539 0503 1901 1940
 Karcher 0783
 Kendo 0699
 Kenwood 0534 0490 0737
 Kiiro 0718 0770
 Kingavon 0818
 Kiss 0665
 Koda 0818
 Koss 0651
 Lawson 0705 0716 0768
 Lecson 0696
 Lenco 0699 0651 0770 0818
 Lenoxx 0690
 Lexia 0699
 LG 0591 0741 1906
 Lifetec 0651
 Limit 0716 0768
 Loewe 0539 1922
 LogicLab 0768
 Logix 0705 0783
 Lumatron 0705
 Luxman 0573
 Luxor 1004
 Magnavox 0503 0818
 Magnex 0723
 Manhattan 0705
 Marantz 0539
 Mark 0713
 Matsui 0651 0695
 MBO 0690 0730
 MDS 0699
 Medion 0651 0783 0716 0831
 Memorex 0831
 Metz 0571 0713
 MiCO 0723
 Microboss 0718
 Micromaxx 0695
 Micromedia 0503 0539
 Micromega 0539
 Microsoft 0522
 Microstar 0831
 Minax 0713
 Minoka 0770
 Mitsubishi 0713
 Mizuda 0818
 Monyka 0665
 Mustek 0730
 Mx Onda 0651 0723
 NAD 0741
 Naiko 0770
 Neufunk 0665
 Nordmende 0831
 Omni 0690 0699
 Onkyo 0627 0503
 Optimus 0571
 Orava 0818
 Orion 0695
 Oritron 0651
 P&B 0818
 Pacific 0768 0790 0713 0831
 Palladium 0695
 Palsonic 0689 0672
 Panasonic 0490 1908
 Panda 0783
 Philips 0539 0646 0503 1914
 Phonotrend 0699
 Pioneer 0571 0631 1900 1902
 Pointer 0770
 Powerpoint 0718
 Proline 0651 0672 0790 1004
 Proscan 0522
 Prosonic 0699
 Provision 0699
 Radionette 0741
 Raite 0665
 Rank Arena 0718
 RCA 0522 0651
 REC 0689 0490
 Red Star 0770 0788
 Reoc 0768
 Revoy 0699
 Roadstar 0699 0690 0689 0713 0818
 Rotel 0623
 Rowa 1004
 Saba 0651
 Sabaki 0768
 Salora 0741
 Samsung 0573 0490
 Sansui 0695 0716 0768 0723 0770
 Sanyo 0670 0695 0790
 Scan 0705
 ScanMagic 0730
 Schaub Lorenz 0788 0770
 Schneider 0651 0783 0705 0790 0788
 Scientific Labs 0768
 Scott 0718 0651 0672
 SEG 0665 0713 0768
 Shanghai 0672
 Sharp 0630 0695
 Sherwood 0717 0741 0633
 Shinco 0717
 Silva 0788
 SilvaSchneider 0831
 Singer 0690 0716 0723
 Skymaster 0730 0768
 Slim Art 0770
 SM Electronic 0730 0768 0690
 Smart 0718 0705 0713
 Sonashi 0716
 Sony 0533 0573 1903 1904
 Soundmaster 0768
 Soundmax 0768
 Soundwave 0783
 Standard 0651 0768
 Starmedia 0818
 Sunwood 0788

Codelist RC3 / Lista de códigos RC3

Supervision	0730	0768	Audiosonic	0278	Fisher	0047	0104	0038	Kneissel	0352	0209	0348	0037
SVA		0672	AVP	0352	Flint			0209	Kolster			0209	0348
Synn		0768	AWA	0037	Frontech			0072	Korpel				0072
Tandberg		0713	Baird	0106	Fujitsu			0000	Kuba				0047
Tatung		0770	Basic Line	0278	Funai			0000	Kuba Electronic				0047
Teac	0717	0741	Bestar		Galaxi			0000	Kuwa				0226
		0571	Black Diamond	0642	Galaxis			0000	Kyoto				0072
		0790	Black Panther		GE			0320	Lenco				0278
Technics		0490	Blaupunkt		GEC			0081	Leyco				0072
Technika		0770	Blue Sky	0037	General Technic			0348	LG		0037	0000	0278
Techwood		0713		0352	Genexxa			0104	Lifetec			0209	0348
Tensai		0690		0278	Goldhand			0072	Loewe	0081	1562	0226	0866
Tevion		0651	Bondstec		GoldStar			0000	Logik		0240	0072	0106
Theta Digital		0571	Brandt	0041	Goodmans	0000	0072	0240	Lumatron				0278
Thomson		0551	Brandt Electronique			0037	0081	0348	Luxor	0106	0043	0072	0104
Tokai		0665	Brinkmann	0209	Graetz			0240					0048
Tokiwa		0705	Bush	0072	Granada	0104	0048	0081	Magnavox				0081
Toshiba		0503	Carena	0209				0226	Manesth		0072	0045	0081
Umax		0690	Carrefour		Grandin	0072	0037	0000	Marantz			0081	0038
United	0788	0730	Casio	0000	Grundig	0081	0347	0226	Mark				0278
Universum	0741	0713	Cathay					0072	Matsui	0209	0348	0037	0240
Venturer		0790	CGE	0041	Haaz			0348					0000
Vieta		0705	Cimline	0072	Hanimex			0209	Mediator				0081
Voxson		0730	Clatronic	0072	Hanseatic	0037	0209	0278	Medion		0209	0348	0352
Walkvision		0717	Combitech	0352	Harwood			0072	Melectronic		0000	0037	0038
Welkin		0831	Condor	0278	HCM			0072	Memorex	0104	0000	0037	0048
Wesder		0699	Crown	0278	Hinari	0072	0209	0352	Memphis				0072
Wharfedale		0696	Cyrus	0081				0240	Metz	1562	0347	0081	0226
Windy Sam		0573	Daewoo	0278	Hisawa			0209	Micormay				0348
XBox		0522	0045	0209	Hischito			0352	Micromaxx				0209
XLogic		0770	Dansai	0072	Hitachi	0042	0041	0000	Migros				0000
XMS		0788	Daytron	0278				0240	Mitsubishi			0043	0067
Yamada		1004	de Graaf	0042	Hornophone			0081	Multitec				0037
Yamaha	0490	0539	Decca	0000	Hypson		0072	0209	Multitech		0000	0072	0104
Yamakawa	0665	0710	0209	0081	Imperial			0000	Murphy				0000
Yelo		0718	Deitron		Ingersoll			0209	Myriad				0081
Yukai		0730	Denko	0072	Inno Hit		0240	0278	NAD				0104
Zenith	0503	0591	Diamant	0037	Interbuy			0037	National			1562	0226
		0741	Domland	0209	Interfunk			0081	NEC	0041	0038	0067	0104
			Dual	0041	Internal			0278	Neckermann			0041	0081
			Dumont	0000	International			0037	Nesco		0072	0000	0352
			Elbe	0278	Intervision	0000	0278	0037	Neufunk				0209
			Elcatech	0072	Irradio			0072	Nikkai				0072
			Elin	0240	ITT	0106	0041	0384	Nokia	0104	0106	0315	0041
			Elsay	0072	ITT Nokia			0048			0240	0048	0042
			Elta	0072	ITV			0278	Nordmende	0041	0384	0320	0067
			Emerson	0072	JMB			0209	NU-TEC				0209
			ESC	0278	Joyce			0352	Oceanic	0000	0048	0106	0081
			Etzuko	0072	JVC		0041	0067	0041				0104
			Fast	0897	Kaisui			0072	Okano	0315	0209	0348	0072
			Ferguson	0041	Kambrook			0037	Orbit				0072
			Fidelity	0000	Karcher			0278	Orion		0209	0352	0348
			Finlandia	0104	Kendo	0106	0209	0315	Orson				0000
			0384	0000				0037	Osaki		0000	0037	0072
			Finlux	0000	Kenwood			0041	Osume				0072
			Firstline	0072	KIC			0000	Otake				0209
				0045	Kimari			0047	Otto Versand				0081
				0278									

VCR

Adyson													0072
Aiwa	0307	0000	0209	0348	0352	0037							0041
Akai	0106	0315	0041	0352	0240								0072
Akashi					0072								0072
Akiba					0072								0000
Akura					0072	0041							0000
Alba	0278	0072	0209	0352	0000	0315							0348
					0081								0240
Allorgan					0240								0081
Allstar					0081								0072
Amstrad		0000	0278	0072									0072
Anitech					0072								0000
Ansonic					0000								0000
Aristona					0081								0081
ASA					0037	0081							0081
Asuka	0072	0037	0081	0000	0038								0000

Codelist RC3 / Lista de códigos RC3

Fidelity					0501	K-SAT					0713	Neuhaus		0501	0713	0834	0607	SAT				0501									
Finlandia					0455	Kamm					0713	Neusat					0713	0834	Sat Control				1300								
Finlux				0573	0455	Kaon					1300	Nikko				0713	0723	0200	Sat Partner				0501								
Flair Mate					0713	KaTelco					1111	Nokia				1023	1114	0751	1127	0723	Sat Team		0713								
Force					1101	Kathrein			0658	0249	1057	0173			0853	0573	1223	0455	1723	Satcom		0605	0607								
Fortec Star					1017	1083			1221	0200	0713	0668	0742					1310	1312	Satec		0713	0834								
Foxtel		0879	0720		0455	0497			0123	0115	1323	0710								Satline			0628								
					0795	1176	Kathrein Eurostar					0115								0879	Satstation		1083								
Fracarro					0871	0668	Kiton					0114								1294	Schneider	0710	0668	0157	1206						
Freecom					0501	0173	Klap				0668	0710								0668	Schwaiger	0605	0157	0607	0885						
Freesat						0882	Konig					0607								0133			1111	0132	1075						
FTEmaximal					0713	0863	Koscom				0834	1043								0834	SCS			0115	0299						
Fuba		0396	0173	0573	0115	0299	Kreiling			0658	0249	0114							0879	0853	Seemann				0396						
Fugionkyo						1105	Kreiselmeyer					0173			1099	1100	0200	0501	0157		SEG	0605	0742	0114	1087						
Galaxis		1111	1101	0834	0863	1176	Kyostar					0132								0497	Seleco				0871						
0853		0115	0879				L&S Electronic					1043								1205	Septimo		1205		0885						
Garnet						1075	Labgear					1296									0668	Siemens			0173						
GF					0834	1043	LaSAT		0607	0115	0132	0157	0299						0455	0847	0887	1175	0241		0713						
GF Star						1043	Lenco				0713	0115	0607						0867	0123	1323	0791	0795		0501						
GOD Digital						0200	Lenson						0501						0720	0497	0200	0853	0710	1423		0713					
Goldbox						0853	Lexus					0200									0710	Sky	0847	0856	0887	1014					
Goldvision						1017	LG					1075									0299	SKY+				1175					
Gooding						0571	Lifesat			0605	0299	1043	0713							0571	0501	Skymaster	0713	0605	0157	1200					
Goodmans				1284	0455		Logix					1017	1075								0501		1085	1075	0628						
Gradiente						0887	Lorenzen		0299	1294	0607	0742	0132							0879	0615	Skymax			0200						
Granada						0455	Luxor				0573	0501								0847	1104	0455	1320		0157	0605	0713				
Grandin						0084	M&B1					0605							0455	0607	0173	0834			0132	0742					
Grundig		0173	0847	1150	1291	1435	Manata				0710	0668	0713								0668	SM Electronic		0157	0713	1200					
		0571	0750	0879	0885	0853	Manhattan		1083	0455	0710	0668								0200	1114	0853	0455	0750	1075	1085					
					1297	1330					0834	1017							0710	0668	0571	0173	0133	1336		0132	0299	1101	0882		
Hanseatic				0605	1099	1100	Marantz					0200									0863	1017	1200			0396	1113	0115	0713		
Hänsel & Gretel					0132	0607	Maspro		0750	0713	0173	0571								0329	0853	0352			0282	0847	0853	0455			
Hauppauge						1294	Matsui			0571	0710	0173									0871	0396						0132			
HDT						1011	Max					0607										0396						0713			
Heliocom						0607	MB					0605										0511						1300			
Helium						0607	Mediabox					0853									0132	0396	1101	1113			0713				
Hirschmann		0396	0882	1113	1111		Mediacom					1206								0853	1114	1127	0723	1111			0132				
		0173	0573	1085	0299	0501	MediaSat				0501	0853							1176	1195	1100	0249	0658	1435			0455				
					0710	0607	Medion			0713	0299	1043											1111					0455			
Hitachi						0455	Medison					0713									0668	0710						0455			
HNE						0742	Mega					0200										0455						1200			
Houston						0668	Metronic		0713	1215	0084	0885	1205									0628					0200	1099	1100	1195	
Humax						1176	Metz					0173										0742					0501	1322			
Huth		0132	0607	1017	1075		Micro			0607	0501	0713										0571						1206			
Hyundai				1011	1159	1075	Micro electronic					0713										0834						0607	0885		
ID Digital						1176	Micro Technology					0713								0628	0668	0710	1323					1017			
Imex						0084	Micromaxx					0299									0607	0742	0115					0114			
Ingelen					0396	0882	Microtec					0713										0200				0605	0115	0607			
International						0132	Minerva					0571								0396	1113	0882					1043				
Interstar						1105	Mitsubishi					0455										0200						0713			
Intervision					0628	0607	Morgan's			0200	0713	0132										0713					0710				
Invideo						0871	Motorola					0856										0628	0713			0396	0750	0501	0607	0834	
IRTE						0609	Multichoice				0642	0879								0710	0885	0115	0607				0605	0607			
Italtel						0871	Multitec					0157										0455				0501	1099	1100	0114		
ITT Nokia		0573	0455		0723		Myryad					0200									0820	1114	1253				0200	0157			
JOK						0710	Mysat					0713								0863	1243	1343	0853	1206				0114			
JVC						0571	Netgem					1322										1017	1293	1292			0455	0501	0132		

Codelist RC3 / Lista de códigos RC3

Thomson	0455 0713 0853 0115 0607	NTL Cabletoll	0276
	12910820 0668 0710 1046	Ono	1068
Thorn		Optus	0276 1060
Tokai		Pace	1068 1060
Tonna	0455 0668 0501 0713 0834	Philips	0817 0286
Topfield		PVP Stereo Visual	0003
Toshiba		Sagem	0817
TPS		Tele+1	0443
Triasat		Telepiu	0443
Triax	0501 0115 0200 0396 0713	Tudi	0286
	08530114 1296 1291 0132	United Cable	0003
Turnsat		Visiopass	0817
Twiner			
UEC			
Uher			
Unisat			
Universum	0173 0571 0607 0299		
	0115 0742 1087		
Van Hunen			
Variosat			
Ventana			
Vestel			
VH-Sat			
Viasat	1323 1023 0820		
Visionic			
Visiosat			
Wetekom	0157 0605 0501		
Wewa			
Wisi	0173 0396 0299 0455 0501		
	0607 0834		
Worldsat	0710 0114 0123 0668		
XCOM			
XSat	0668 0713 0123		
Xtreme			
YES			
Zehnder	1075 0742 0114 0115 0419		
Zenith			
Zeta Technology			
Zinwell			

Cable Box (STB)

Austar	0276
BT	0003
Canal Plus	0443
Comcrypt	0443
Decsat	0423
Filmnet	0443
France Telecom	0817
General Instruments	0276
Jerrold	0003 0276
Kabelvision	0003
Macab	0817
Melita	0003
MNet	0443
Mr Zapp	0817
Noos	0817

Free Manuals Download Website

<http://myh66.com>

<http://usermanuals.us>

<http://www.somanuals.com>

<http://www.4manuals.cc>

<http://www.manual-lib.com>

<http://www.404manual.com>

<http://www.luxmanual.com>

<http://aubethermostatmanual.com>

Golf course search by state

<http://golfingnear.com>

Email search by domain

<http://emailbydomain.com>

Auto manuals search

<http://auto.somanuals.com>

TV manuals search

<http://tv.somanuals.com>