



Operating instructions

TV

- Concept L 32
- Concept L 32 Basic
- Concept L 26
- Concept L 26 Basic

LOEWE.



Contents

| | | | |
|---------------------------------------|-----------|--|-----------|
| Remote control - TV functions | 3 | Operating modes – PIP | 22 |
| Control Unit | 4 | PIP picture as freeze picture | 22 |
| Connections to rear panel | 5 | Selecting the station of the PIP picture | 22 |
| Welcome | 6 | Select the station of the TV picture (main picture) | 22 |
| Integrated features | 6 | PIP scan in the PIP picture | 22 |
| Scope of delivery | 6 | Interchanging PIP picture/TV picture | 22 |
| Transporting | 6 | Functions in the PIP menu | 23 |
| Installation options | 6 | Setting the PIP type | 23 |
| Note on the LCD screen | 7 | Position of the PIP picture | 23 |
| Cleaning | 7 | Operating modes – EPG | 24 |
| Disposal | 7 | Using the EPG | 24 |
| For your safety | 8 | EPG menu | 25 |
| First installation | 9 | Selecting providers and stations | 25 |
| Remote control | 9 | Data capture | 25 |
| Connection | 9 | Operating modes – Teletext | 26 |
| Handling the fabric hose (optional) | 10 | Page selection with the coloured keys | 26 |
| Using the Conditional Access module | 10 | Displaying teletext pages | 26 |
| Switching on | 10 | Programme timer recordings | 27 |
| Automatic programming | 11 | Teletext menu | 27 |
| Directing DVB-T antenna | 12 | Digital teletext operation (only for MHEG-5 device versions) | 27 |
| Daily operation | 12 | Operating modes – Radio | 28 |
| Switching on/off | 12 | Radio menu | 28 |
| Changing stations | 13 | EPG - Programme guide | 28 |
| Basics about the menu operation | 14 | Operating additional equipment | 29 |
| For the info system ... | 15 | Login and connect equipment | 29 |
| For the index ... | 16 | Video playback | 30 |
| Setting the sound | 17 | Timer recording with video or DVD recorder | 30 |
| Picture settings | 17 | Assignment of digital audio inputs and outputs | 31 |
| Direct control on TV set | 17 | Connecting Loewe DVD Preceiver Auro 2216 PS and Individual Sound loudspeaker system | 32 |
| Operating modes – TV | 18 | Connecting other audio amplifiers or active speakers | 33 |
| How the coloured keys work in TV mode | 18 | HDMI (DVI) connection | 34 |
| Show status display | 18 | VGA/XGA connection | 34 |
| Calling the index | 18 | Component video connection | 35 |
| Call additional functions | 19 | Operating Loewe video recorders and Loewe DVD players directly | 36 |
| Call timer overview | 19 | What to do, if ... | 37 |
| Select picture format | 19 | Technical data | 39 |
| Move picture up/down | 19 | General data | 39 |
| TV menu | 19 | Electrical data | 40 |
| DVB subtitles | 20 | Accessories | 41 |
| Removing the CA module | 21 | Service | 43 |
| Inserting a new CA module | 21 | | |
| Installing new DVB software | 21 | | |

Remote control - TV functions

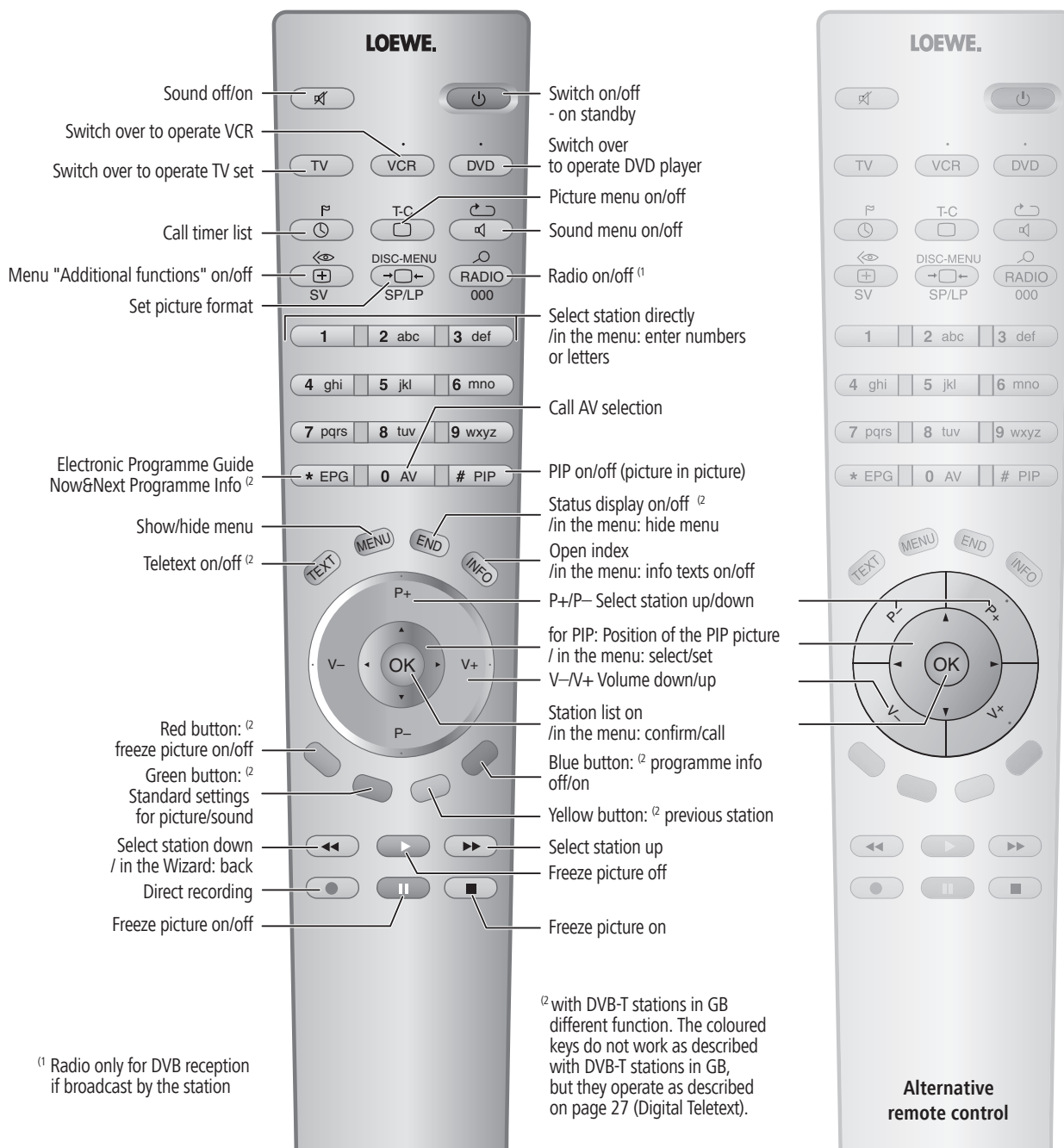

Control Unit

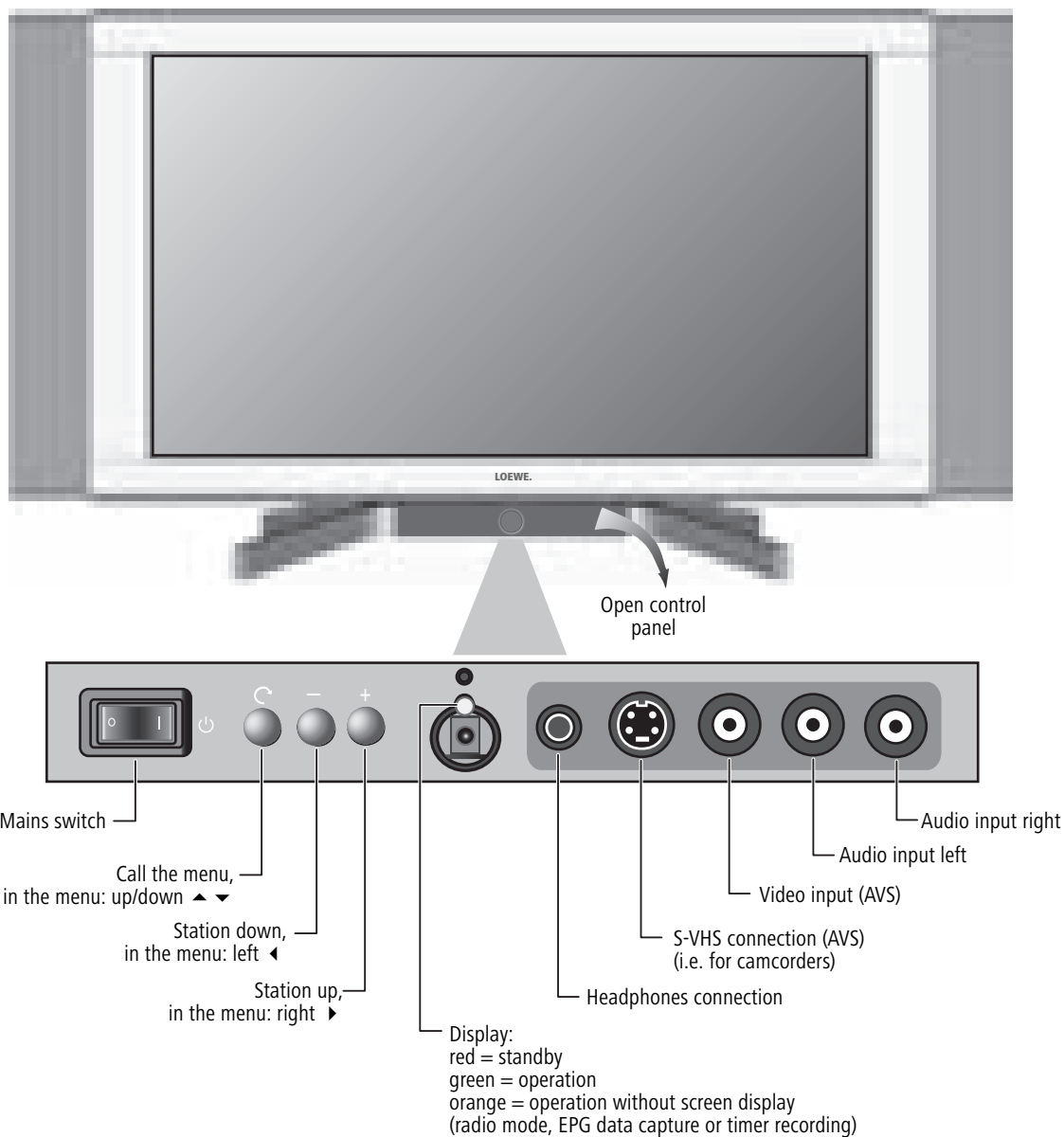

Connections to rear panel

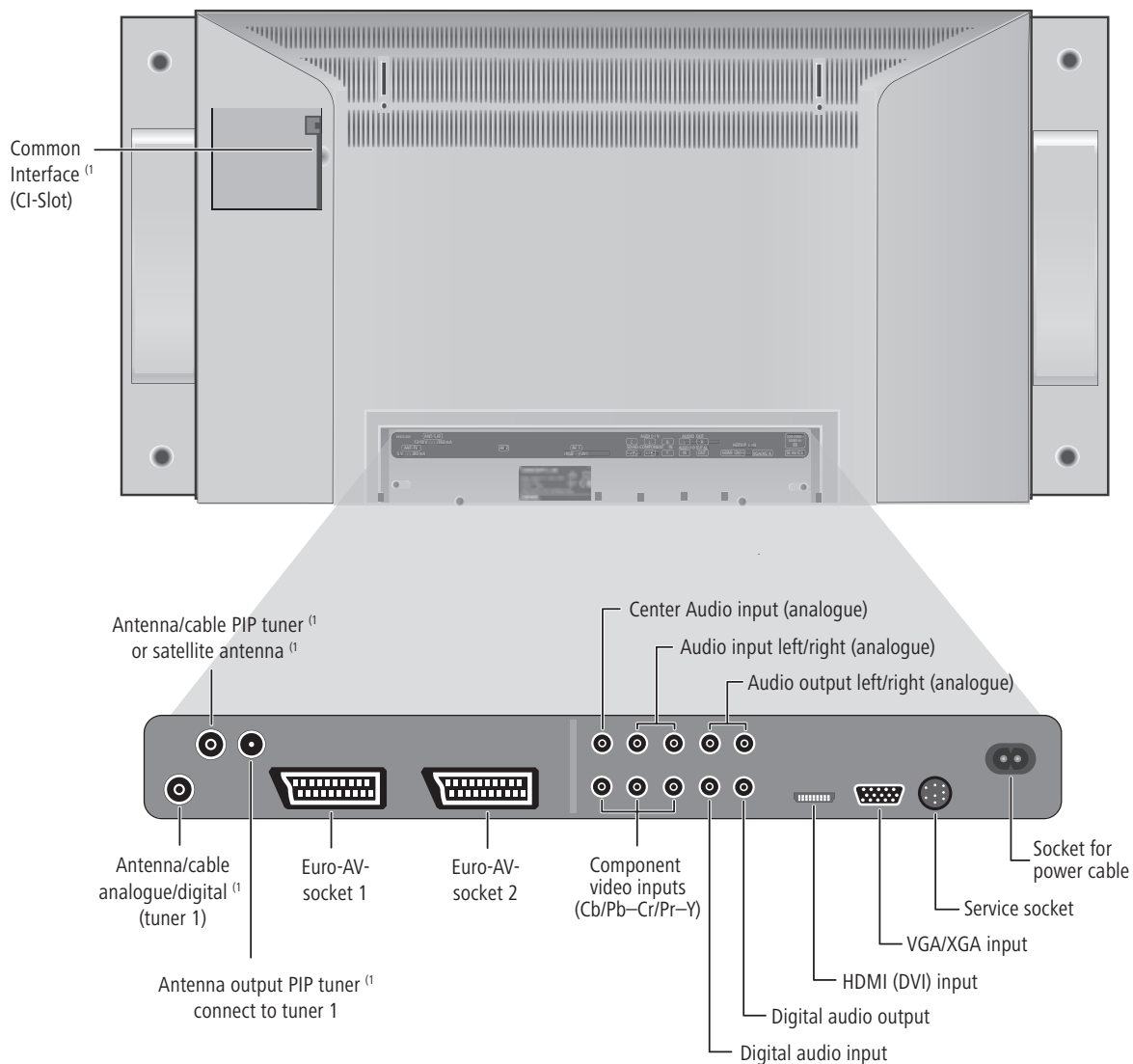

⁽¹⁾ Set-specific equipment and retrofitting options for CI-Slot, PIP and satellite tuners, see pages 41 and 42.

Welcome

Thank you!

At Loewe, we combine the highest standards of technology, design and user friendliness. This applies equally for TV, video and accessories.

Your new TV set is ideally equipped for the TV standard of the future - "HDTV" (High Definition Television). With its high-resolution screen and the future-proof digital interfaces HDMI, you have the option to view HD content with excellent picture quality. It therefore carries the European quality mark "HD ready".

Digital TV is steadily spreading via terrestrial reception, in the cable network and via satellite. Loewe supplies sets equipped with DVB-T and DVB-C (DVB-C not for GB). A digital satellite tuner (DVB-S) can be retrofitted. The DVB integrated within the TV set is operated via the TV set menus using the remote control.

We have designed this TV set so that it is easy to operate by using menus. Information about settings in menus is shown automatically; this enables you to understand the context quickly.

You will find the answers to many of your technical queries in the index of your TV. If you want to operate the TV, you can access functions directly from the index. This saves you from having to read through detailed operating instructions and is the reason why this operating manual only explains the most important operating steps.

Integrated features

The maximum equipment is described in these operating instructions. Functions indicated by * are not available in all TV sets. Menu contents may differ from the ones shown, depending on how your TV is equipped.

You can display how your set is equipped in the "Integrated features" index (press the **INFO** button in the TV mode if no menu is displayed; the "Integrated features" menu item is also displayed in the index before the initial letter A).

Scope of delivery

- LCD-TFT TV set
- Mains cable
- RC4 remote control with 2 batteries
- Table stand
- Marketing and service card
- These operating instructions

Transporting

Only transport the unit in an upright position. Hold the set by the top and bottom edges of the housing. The LCD screen is made of glass and/or plastic and may break if not handled carefully. Should the LCD screen become damaged or should the liquid crystal begin to leak, then it is imperative you wear rubber gloves when removing the set. Should the liquid come in contact with your skin, thoroughly rinse with water immediately.

Installation options

As a desktop unit

The foot is included in delivery.

As a wall-mounted unit

- Wall holder WM55 for Concept L26 / Concept L26 Basic, Loewe order no. 65497 A00.
- Wall holder WM54 for Concept L32 / Concept L32 Basic, Loewe order no. 65498 A00.

Welcome

Note on the LCD screen

The TV set with an LCD screen you have purchased meets the highest quality requirements and has been tested for pixel errors. Despite the utmost caution in production of the displays, it cannot be totally ruled out that some of the pixels might be defective for technological reasons. Please understand that such effects cannot be considered a unit defect as defined by the warranty as long as they are within the limits specified by the standard.

Cleaning

Use only a soft, clean, damp cloth to clean the TV set, the screen and remote control (do not use any caustic or abrasive cleaning agents).

Disposal

Packing and box

You have chosen a long lasting technical product of very high quality. We have paid a fee to authorised recyclers who will collect the packing from your dealer for disposal, pursuant to domestic regulations. Nevertheless, we recommend you to keep the original box and packing material for optimum protection if you have to transport the set.

The set



Attention: The EU directive 2002/96/EC regulates the proper way to recycle, handle and utilise used electronic devices. Hence, all used electronic devices are to be disposed of separately. Please do not dispose of this set in the normal household rubbish.

You may return your used set free of charge at designated recycling centres or at your specialist dealer whenever you purchase a new, comparable set. You can find out more about recycling (also for countries outside the EU) from your local government.

For your safety

For your safety and to avoid unnecessary damage to your TV set, please read and observe the following safety instructions:

- This TV set is designed exclusively for reception and reproduction of video and audio signals.
- This equipment is designed for domestic and office environments and must not be used in rooms with high humidity (e.g. bathroom, sauna) or high concentrations of dust (e.g. workshops). If the equipment is used in the open air, ensure that it is protected against moisture (rain, drips, splashes, sprayed water or dew). Do not place any containers filled with liquids or lit candles on top of the TV.
High levels of moisture and concentrations of dust cause leakage currents in the equipment, which can lead to danger of electric shock or fire. The manufacturer's warranty is only valid for use in the specified permissible environment.
- If you have moved the TV set out of the cold into a warm environment, leave it standing for about an hour since condensation may form.
- This equipment must only be connected to a mains power supply which has the same voltage and frequency as that specified on the rating plate; use the power cable provided. Incorrect voltages can damage the equipment.
- Like all electronic equipment, your TV needs air for cooling. Obstruction of the air circulation can cause fires. Therefore the air vents on the back must always be kept free. Please do not place newspapers or cloths on/over the TV.

If the TV is placed in a cabinet or on a shelf, leave at least 10 cm at the sides and 10 cm at the top to ensure sufficient air circulation. Position the set so that it is not exposed to direct sunlight and additional heating from radiators.

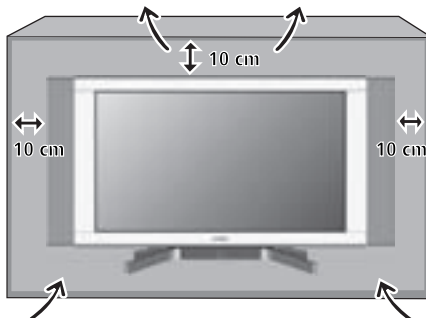
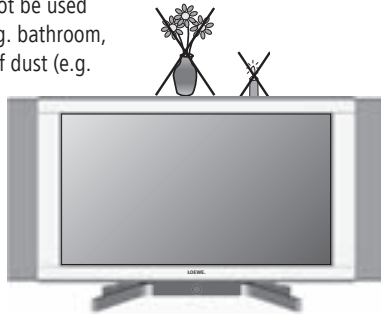

- Prevent any metal parts, needles, paper clips, liquids, wax or the like from getting into the TV set through the air venting slits in the rear panel. This can lead to short-circuits and possibly to fire. If something should get into the inside of the TV set, pull out the plug immediately and notify customer service.
- Never remove the back of the TV set yourself. Repair and servicing of your TV set should only be carried out by authorised TV technicians.
- Place the TV set on a level, firm base. The set should not protrude at the front when installing in cabinets or shelves. Only use original accessories if possible, e.g. Loewe wall holders and stands. Never let children handle the TV unattended. Do not allow children to play in the immediate vicinity of the TV, they could knock, shift or pull it over and injure someone. Never leave the TV on unsupervised.
- Do not install the TV where there may be vibrations. Vibrations can lead to material stress.
- Pull out the power and antenna cables during thunderstorms. Surge voltages caused by lightning strikes can damage the TV through the antenna system and the mains. Also remove the antenna and mains plugs in long periods of absence.
- The mains plug of the TV set must be easily accessible so that the set can be disconnected at any time.
- Lay the mains cable in such a way that it will not be damaged. The power cable may not be kinked or laid over sharp edges, not stood on and not exposed to chemicals, the latter also applies to the device as a whole. A mains cable with damaged insulation can lead to electric shocks and is a fire risk.
- When removing the mains plug, pull the plug housing and not the cable. The wires in the plug could be damaged and cause a short circuit the next time it is plugged in.

The rating plate of the TV is on the rear of the set.

First installation

Remote control

Batteries

To insert or change the batteries, press on the arrow. Slide the battery compartment cover downwards and remove it. Insert LR 03 alkaline-manganese batteries (AAA) and ensure that the + and - ends are positioned correctly.

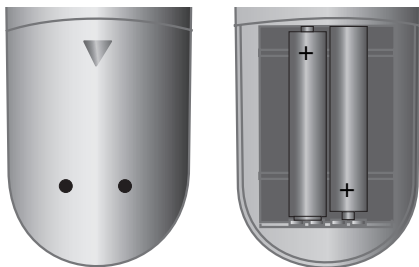

Then push the cover back on from the bottom.

Note on disposing batteries



The batteries provided contain no harmful materials such as cadmium, lead or mercury. Regulations concerning used batteries stipulate that batteries may no longer be thrown out with the household rubbish. Deposit any used batteries free of charge into the designated collection containers set up at commercial businesses.

Setting up the remote control for operating the TV

TV

Push the TV button.

How to operate other equipment is described as of page 36.

Connection

Power mains

Connect the TV set to a 220-240V/50- 60 hertz power outlet. Plug the small plug of the mains cable into the mains socket on the rear of the TV set; plug the large mains plug into a mains socket.

Antennas

Plug the antenna plug of your antenna/cable system or the room antenna for DVB-T into the ANT-TV socket.

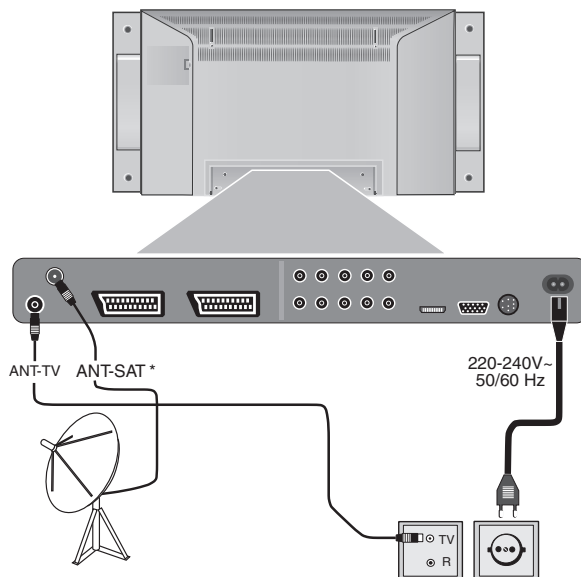

First installation

If the reception conditions are good, then a room antenna may be used for DVB-T. Passive and active room antennas are available on the market. The power is supplied for an active antenna via the antenna connection. For automatic programming or in "TV Menu – Connections – Antenna DVB – Antenna DVB-T," the distribution voltage (5 volts) is to be set correspondingly. It may be practical to use a nondirectional antenna. If the location is outside the normal transmitting range, then a unidirectional antenna may also be used to improve the reception quality.

You can find out more on the digital stations that can be received in your area at your specialist dealer.

If a set was retrofitted with a PIP tuner, then plug the antenna into the antenna input of the PIP tuner and connect the PIP tuner output with the ANT-TV socket (Tuner 1). See illustration on page 5.

Set-specific equipment and retrofitting options for CI-Slot, PIP and satellite tuners, see pages 41 and 42.

If a Digital Satellite Tuner has been retrofitted, connect your satellite antenna system to the ANT-SAT socket.

When laying the cable, use the cable clips affixed beneath the TV set.

Handling the fabric hose (optional)

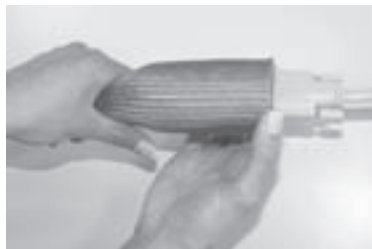

Use the fabric hose for tidy laying of the power cables, antenna cables or cables of other electronic components and lay the hose with the cables to the connecting sockets. This provides you with an elegant solution when laying cables. The diameter of the fabric hose increases when you push it to-

gether lengthwise (see illustration). This makes it easier for you to push through cables with plugs.

You can obtain the fabric hose as an accessory from your Loewe dealer or Loewe Customer Service.

Using the Conditional Access module

(Only for sets with CI slot)

In order to be able to receive encrypted digital stations, a Conditional Access module (CA-module⁽¹⁾) and a Smart Card⁽¹⁾, if necessary, must be inserted into the corresponding slot of your TV set. You can find the Common Interface slot (CI-Slot) on the back of your TV set, see the illustration on page 5.

1. Make sure the TV set is switched off with the mains switch on the set.
2. First push the Smart Card into the CA-module as far as it will go. Insert it so that the side with the golden contact chip faces the side of the module printed with the supplier's brand logo. Printed arrows indicate how to insert the card. Also follow the installation instructions included with the Smart Card.

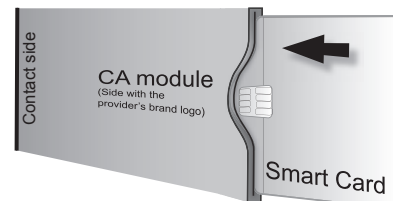

3. Push the CA module carefully into the slot contact side first. When you are standing in front of the TV set, the logo on the CA module must face the rear. Make sure the module is not twisted in the process. Do not use force. When the module locks, the eject button is pressed outwards.

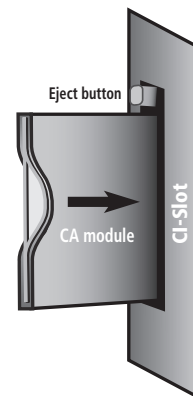

⁽¹⁾ The CA-module and the Smart Card are not included in the scope of delivery of this set; you can usually obtain them at your specialist dealer.

Switching on



Switch the TV set to standby with the Mains switch on the front behind the flap.

The red indicator on the set now lights up (standby mode).



From standby (red LED lights) it is best to switch on the TV with the blue On/Off button or a numeric button on the remote control.

First installation

Automatic programming

Automatic programming of the TV set is started the first time you switch it on. Follow the menus.



By pressing in one of the arrow directions, you can choose the settings ...



... and confirm your settings by pressing **OK**. You then go to the next menu.



Back to the previous menu.

1. First you have to select the menu language.
2. By pressing the **OK** button, you can call the menu "Connect antenna cable(s)". If you want to receive digital stations via satellite, then choose "DVB-S" - confirm using the **yellow** coloured key. If you also want to receive digital terrestrial stations (DVB-T), then select "DVB-T". Also select "Antenna/cable (analogue)" - this way the standard analogue stations can also be searched for and saved. If you can receive digital stations from the cable network, then select "DVB-C" using the **yellow** coloured key.
3. For the country-specific station sorting and for presets for DVB-T and DVB-C, enter the location at which the TV set is operated.
4. If you have selected "DVB-T", you then reach the menu "Antenna DVB-T". If you use an active antenna, then select "yes (5V)".
5. If you have selected „DVB-C“, you generally leave the symbol rates and modulation types unchanged. If other symbol rates are used in your cable network for broadcasting, enter the values with the numeric buttons of the remote control. If only one symbol rate is used, enter the same value for both symbol rates. If other modulation types are used for broadcasting in your cable network, select them in the menu. If only one modulation is used, select „none“ for modulation type 2. If necessary, ask your specialist dealer about the necessary settings for your cable network.
6. In the "Select satellite installation" menu, make the selection that corresponds to your satellite antenna installation.
Note: If you have any questions on how your satellite antenna installation is configured and on the antenna settings, consult your antenna installer or your specialist dealer.
7. Select the satellite the antenna is directed at, such as ASTRA1.

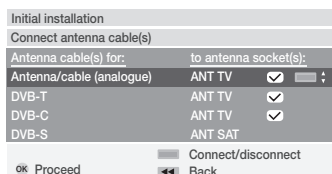

If you only receive one satellite ...

8. In the following menu, specify whether the station search should take place in the high and low band ("Yes") or only in the low band ("No").

Note: For most satellites, a station search is required in both bands.

9. For the low band and high band, the standard frequencies 9750 MHz (9.75 GHz) and 10600 MHz (10.6 GHz) are preset.

If your satellite antenna is equipped with an LNC (LNB) with a divergent oscillator frequency, specify the corresponding frequency for low and high band respectively.

Note: The correct display of the received frequencies in the "TV menu – Settings – Stations – Manual adjustment" depends upon this setting.

10. You should receive a picture with sound with the settings previously made (only for ASTRA 1 and HOTBIRD). Then press **OK**.

11. In the "Pre-programming" menu, select the factory-set pre-programming to programme the satellite stations quickly.

To ensure all stations that can be currently received are searched for and saved, select "No" at this point.

Symbol rates: The standard symbol rates 22000 and 27500 are preset. If you would like to receive stations with different symbol rates, specify the corresponding values here using the numeric buttons on your remote control.

12. Press **OK** to obtain an overview of the settings with which the automatic programming is to take place.
13. Press the **OK** button again and the station search will start. The TV set searches for, sorts and saves all the TV stations that can be received, according to your settings and the antennas connected.
14. When the TV stations are saved, you will receive a corresponding message.
15. Press the **OK** button and the set then searches for the radio stations.
16. The TV set searches for, saves and sorts all radio stations which can be received with your antenna system.
17. Then log on your video equipment, decoder and audio system using the connection wizard and connect these to the TV according to the connection diagram displayed. If you want to connect other equipment later, you can find information as of page 29.

You can repeat the initial installation at any time, e.g. after moving house. Call the index using the **INFO** button (in the TV mode, if no menu is opened). Select the index item "Repeat initial installation" (you will find this listed separately before the letter A). Press **OK** to start the initial installation.

Note: For DVB-T stations in GB the stations are tied to "Logical Channel Numbers" -- "LCN" and sorted from 1-799. Digital stations without "LCN" are stored from 800 onwards. Analogue stations are stored from 1001.

Station sorting

Note: not with DVB-T stations in GB.

You can change the station sorting that was carried out automatically later at any time, see "TV menu – Settings – Stations – Change stations".

First installation

Directing DVB-T antenna

Note: not with DVB-T stations in GB.

If you use a room antenna to receive one or more DVB-T stations that have picture and sound interference, then you should change the location of where the antenna is set up.

To help you direct your antenna or to help you determine the most suitable location to set up the antenna, your TV set has a display for the signal quality **C/N** and the signal strength **Level**.

Consult your specialist dealer to find out which channels and frequency bands (VHF or UHF) are used to broadcast the digital TV stations in your area.

On any one channel, several digital stations are broadcast.

Select a TV channel

1. Call the "TV menu" via the **MENU** button.
2. Use **◀ ▶** to select "Settings", then use **▼** to select the menu line underneath.
3. Select "Stations", then use **▼** to select the menu line underneath.



4. Select "Manual adjustment" and call the menu using **OK** (not possible for MHEG-5 device versions).

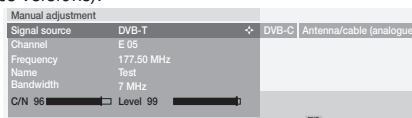

5. For digital stations, select "Signal source – DVB-T".
6. Use the **numerical buttons** to specify the corresponding channel number. Depending on the channel selected and country, the system automatically sets the corresponding bandwidth of 7 or 8 MHz. You should only change the bandwidth under special circumstances - if the channel raster in your area is different from the standard.
When you receive a digital station, the system displays the signal quality **C/N** via a bar/numeric value and the signal strength via **Level**. The antenna's direction or position is best when the largest values possible are displayed (long bar) for the signal quality and signal strength.
7. Direct the antenna so that the largest numerical value/bar size is reached.
8. If no signal is found in the channel set, you can start the frequency search run by pressing the **blue** button within the band selected (VHF or UHF).
9. Check the other channels one after another on which digital stations are broadcast terrestrially in your area.
For the weakest station, direct the antenna so that the maximum numerical value/bar size is achieved.
10. After you position or direct the antenna, we recommend to search for all the stations using the "Search wizard" (TV menu – Settings – Stations – Search wizard).

Daily operation

Switching on/off

Your TV is equipped with an eco-standby power supply unit. On standby, the power consumption drops to low power. If you want to save even more electricity, switch the set off with the mains switch. However, please bear in mind that EPG data (electronic programme guide) will be lost and programmed timer recordings will not be performed by the TV.

Switching off



If the TV set is switched on, you can switch it to standby using the blue ON/OFF button on the remote control. The red lamp on the TV set lights up. If the orange indicator lights up, a timer recording is being made, EPG data is being captured or radio operation without screen display is active.

Switching on the TV set



From standby, it is best to switch the set back on using the blue On/Off button or by using the numeric buttons of the remote control (0 – 99).

The green indicator on the TV set lights up.



Or switch on the TV set with **OK**, you can then see the station list and select a station.

Switching the radio on



With the **RADIO** button on the remote control.

If you switch off the TV set using the mains switch  on the set, the indicator no longer lights up.

If the TV set is switched off via the mains switch, you have to switch it into the standby mode first via the mains switch and then switch it on using one of the above mentioned methods.

Daily operation

Changing stations

... with the P+/P- buttons on the remote control

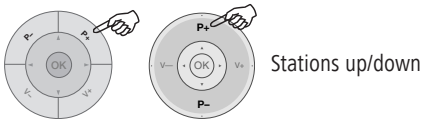

When changing, the station display is visible for a few seconds.

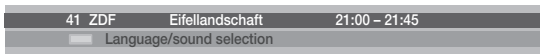

If additional languages are broadcast with DVB stations, then the set displays the language/sound selection under the station display. Call the language/sound selection by using the **green** coloured key and select using ▲ ▼.

... with the numeric buttons of the remote control

The set has a dynamic memory with 430 (with DVB 1680) station memory locations. If up to 9 stations are stored, you only need to enter one digit; up to 99 stations, two digits are needed; up to 999 stations, three digits are needed (refer to the station list to see how many stations have been stored).

7 pqrs
long

1 digit stations

Press buttons 0-9 for one second, and the station changes instantly.

Or press button 0-9 briefly, the station then changes after 2 seconds (the station changes immediately when only 9 stations are saved).

1 2 7 pqrs
short short long

2- and 3-digit stations

After briefly pressing the first numeric button(s), keep the last numeric button pressed for one second, the station then changes immediately.

Or press all numeric buttons briefly, the station then changes after 2 seconds (the station changes immediately if up to 99 or 999 stations are saved).

1 2 7 8 tuv
all short

4 digit stations

Press the four numeric buttons briefly, the station then changes immediately.

Call last viewed station (for DVB-T stations in GB)



You can switch back and forth quickly between two stations using this button.

... via the station list



Use OK to call the station list.

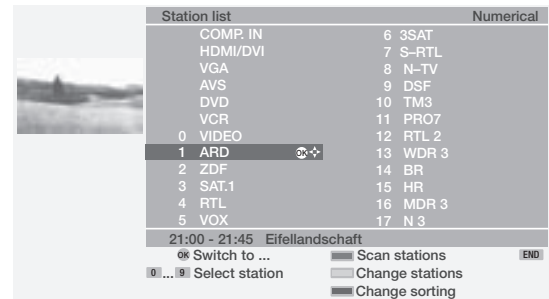

Select the station (if possible, the selected station will be displayed as a small picture)

or ...



... select with numeric buttons



call selected station.



Blue coloured key: sort alphabetically/according to bouquets/numerically.

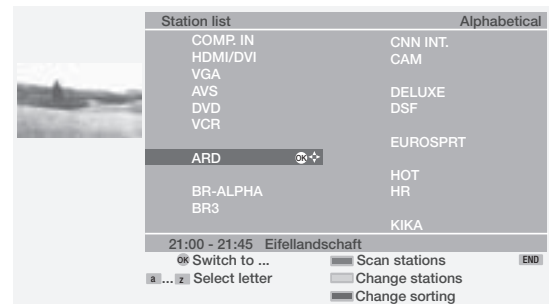

For an alphabetical display: Enter letters with the numeric button (like on a mobile phone keypad), select with ▼ ▲ ◀ ▶ and call with OK.

For bouquet display (sorting according to broadcasting chains, only for DVB stations, not for DVB-T stations in GB): Enter bouquet number, select with ▼ ▲ ◀ ▶ and call with OK.

Digital DVB-T stations are indicated by **T**, DVB-C stations by **C** and DVB-S stations by **S**. Encrypted stations are additionally indicated by **EN**.

Ask your specialist dealer about decoders or the use of a CA module and a Smart Card for the reception of encrypted stations.

Daily operation

Basics about the menu operation

Menus are called via the **MENU** button or via the button for special menus and can be hidden by using these buttons or by using the **END** button. The menu is displayed in the bottom section of the screen. At the top, you can see additional information for the menu point selected. In the menus, navigate by using the cursor \blacktriangle \blacktriangledown \blacktriangleleft \blacktriangleright . You can make settings by using \blacktriangleleft \blacktriangleright . When you exit the menu, the settings are adopted.

Example of the menu operation

We shall demonstrate how to navigate with the menus using the TV menu as an example. You can see which buttons you can use in the dark blue field on your TV set.

MENU

Open TV menu (in TV mode).



Select the function in the TV menu, e.g. "Sound" (for sound settings). Use \blacktriangleright to move the menu points displayed on the right into the dark blue field; use \blacktriangleleft to move the menu points displayed on the left.

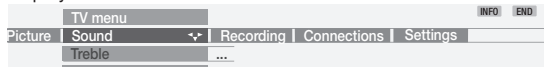

Select the sound function below with \blacktriangledown or **OK**; you will then see a list of the sound settings.



In the sound settings, also select the function with \blacktriangleleft \blacktriangleright , e.g. "Bass" (for increasing or reducing the bass tones).

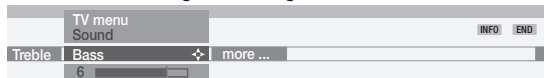

To set the bass tones, use \blacktriangledown or **OK** to select the setting bar underneath.

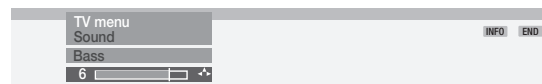

Set the bass tones by using \blacktriangleleft \blacktriangleright .



If you want to make other sound settings, move up with \blacktriangle to "Bass" and select with \blacktriangleleft \blacktriangleright , e.g. "more...". You can also move up further to "Sound" by using \blacktriangle and select other settings in the TV menu (such as, picture settings).



Use **OK** to call additional sound settings.

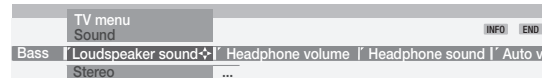

Select the sound setting using \blacktriangleleft \blacktriangleright , e.g. "Auto volume" and ...

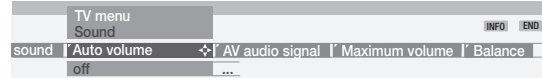

... use \blacktriangledown to select the auto volume option.



Use \blacktriangleleft \blacktriangleright to select "on" and activate the auto volume.



END

Press the **END** button to hide the menu.

Apart from the TV menu shown here, other menus can be opened in TV mode as follows:



Call the Sound menu directly.



Call the Picture menu directly.



Quick calls for teletext subtitles, personal text pages, headphone volume, scan stations and to move the picture up and down.



Green coloured key: Call standard settings for picture and sound.

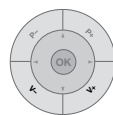

Using the volume control, you can also open other sound settings, such as Sound via, Sound adjustment, Sound effects and Loudness.

The key \blacktriangle or **OK** must be pressed for the duration of the volume display for this.

Daily operation

For the info system ...

For each menu point, an info text is displayed at the top of the picture to help you with the setting. This saves you from having to refer back to the operating instructions. We shall demonstrate this using the station search option as an example:



Call the TV menu.



Select "Settings".

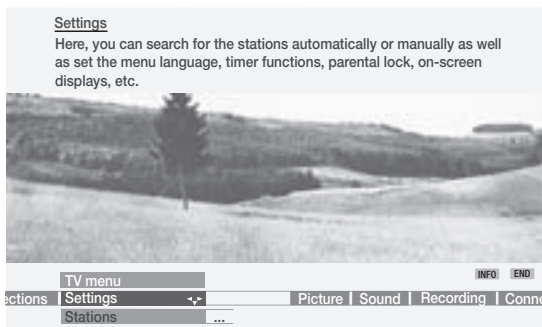

In this example, you can see the options available after "Settings".



If you want to search for new stations, for example, use ▼ to select "Stations" in the line below.

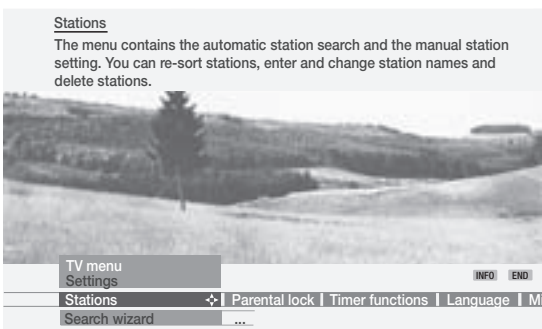

The info text indicates which settings you can make in "Stations".



Use ▼ to select the line below, for example "Search wizard".

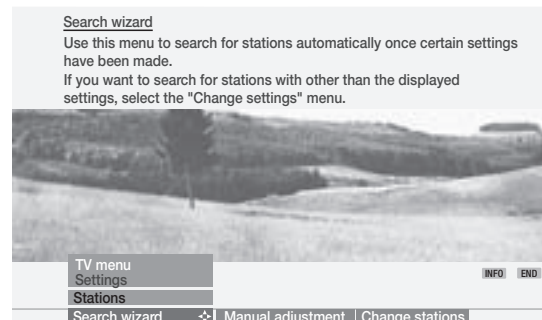

The info text explains how you are to proceed.

Upon delivery, the TV set is configured so that the info texts are always displayed (Automatic info "yes"). In this case, you can hide the info texts by using the **INFO** button.

You can also configure the TV set so that you call the info texts when needed by using the **INFO** button (Automatic info "no"). You can find the setting to switch the automatic info option on or off via "TV menu under Settings – Miscellaneous – On-screen displays – Automatic info – yes/no".

Daily operation

For the index ...

Using the index, you can access many operational functions directly. You can also find a great deal of information on technical terms about television. Before the alphabetical sorting, you can find the menu language option, the list of features integrated into the TV set and the repeat initial installation option.

INFO

Call the index in the TV mode (without any other on-screen displays).

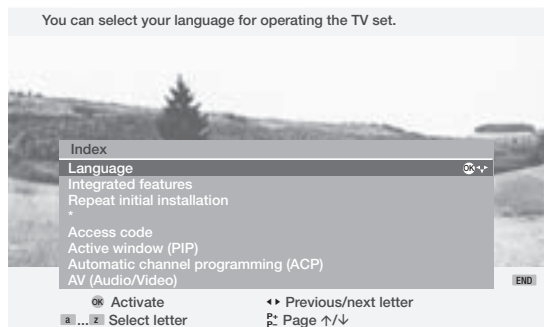

Info on the index item selected is visible at the top of the picture. If the OK symbol is displayed in the line selected, you can use the **OK** button to access the menu directly and carry out settings or selections.

This is how to select the index item:

2 abc

Enter the first letter using the numeric buttons on the remote control (like on a mobile phone keypad);

9 wxyz

or



use ◀ ▶ to go to the previous/next letter,
or

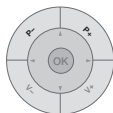

use **P+ / P-** to scroll up or down through the pages



and use ▼ ▲ to go from line to line.

For example, you want to have the TV set switch off automatically:

Select the index item "Switch off" – "Automatic".

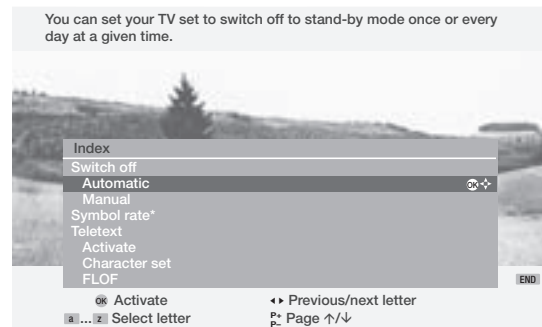

Use the **OK** button to call "Switch off" – "Automatic".

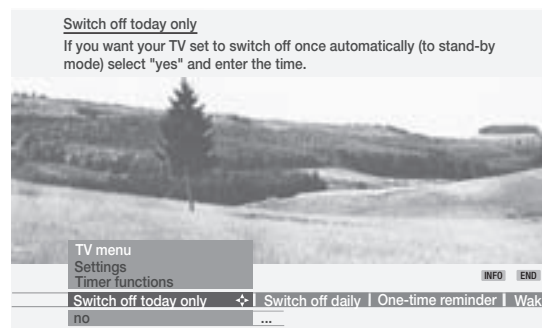

The corresponding menu "Timer functions" is displayed (in the TV menu – Settings). You can now choose between "Switch off today only" and "Switch off daily" and enter the time.

Daily operation

Setting the sound

Volume and other frequently used sound settings



Setting the volume



by using or **OK**, you can call other sound settings ...

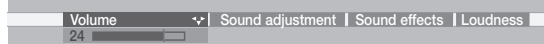

and select using ...

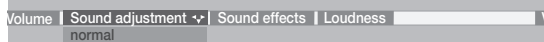

use for the related selection/setting...

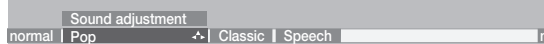

... and use to make the selection/setting there.



Sound adjustment allows you to adjust the sound characteristics to the station's sound. The Sound effects settings allow you to expand a Dolby Pro Logic Signal to a virtual surround signal by using "Dolby Virtual"; by using "Panorama", you can enhance the foundation of the stereo sound virtually for the loudspeakers.

Sound off/on



Sound off;
Sound on: Press button again or adjust volume.



Other sound settings:



Call the Sound menu

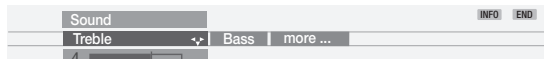

use to select the sound function to be set and use for the related selection ...

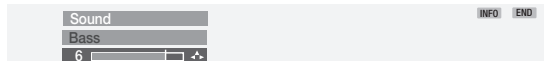

and use to select/set.



Sound settings: Treble and bass. Different menu items are displayed depending on the connected audio device (AURO, hi-fi amplifier). Under "more ..." you will find the sound selection for loudspeakers and headphones, auto volume, headphone volume, AV audio signal, maximum volume and balance.

Picture settings



Open the Picture menu

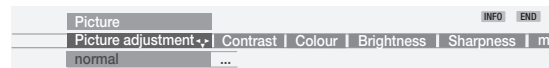

use to select the picture function to be set and use for the related selection ...

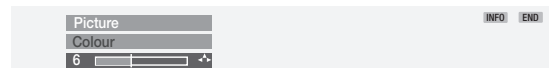

... and use to set/select.

Picture settings: Picture adjustment, Contrast, Colour, Brightness, Sharpness. Under "more ...", you can find settings for Picture format, Move picture up/down and Auto format.

Direct control on TV set

On page 4, you can find an illustration of the control unit located on the set.

Switching station on the TV set



Station up: with the button +



Station down: with the button -

Additional functions via the menu

In the radio or TV operating modes, you can make settings for Volume, Brightness, Contrast, Picture format and Stations. "Service" is intended for the customer service department.



use to call the menu



use or to select the function to be set



use for the related setting/selection



use or to set/select.

Use to move one level up; you can use or to select other functions.

Operating modes – TV

TV

In initial installation and daily operation, the TV set is in TV mode. This is also the case when none of the other modes of operation, such as EPG, Teletext, PIP or Radio, have been selected.

Each of these operating modes has a separate menu with separate functions for the coloured keys. Call the menu via the **MENU** button.

How the coloured keys work in TV mode

Note: The coloured keys do not work as described below with DVB-T stations in GB, but they operate as described on page 27 (Digital Teletext).



Red: the TV picture freezes. Pressing this button again starts the picture moving again.

Green: Call personal settings/factory settings for picture and sound, save picture and sound settings as personal settings.



Yellow: call last station viewed. You can switch back and forth quickly between two stations using this button.

Blue: call programme info.



Show status display



Show/hide status



In the line above, you can see the name of the station and the sound mode. Displayed below are additional options (Time, Sound mode, Alarm time and Sleep timer) that can be selected in the "TV menu – Settings – Miscellaneous – On-screen displays".

For the status display, the DVB station providers may offer additional selection options for each station. Thus, the corresponding colour key or the **TEXT** button is displayed:



Red: channel selection for multi-channel providers.

Green: language/sound selection.

Yellow: time selection.

Blue: protection of minors.



DVB subtitles.

If you press one of the coloured keys during the status display or you press the **TEXT** button, the related selection menu is displayed.

The status display subtitles refer only to the "DVB subtitles" and are not provided by all stations. The options you see depend on the particular station (many stations broadcast subtitles via teletext).

The status display is displayed automatically when a new programme begins with options different to the previous one.

Notes:

- In the sound mode, Mono! means that you have switched manually from stereo to mono, for example.
- The selection menus are only available as long as the status display is displayed. You can call them again at any time by pressing the **END** button on your remote control.

Calling the index



Calling the index

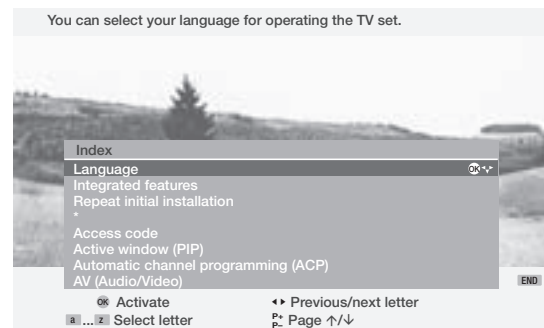

You can find more information on the index on page 16.

Operating modes – TV

Call additional functions



Select additional functions such as Teletext subtitles, Personal teletext pages, Headphone volume, Scan stations and to move the picture up and down.



Call timer overview



If timer recordings have been programmed, you will see when which station is recorded here.

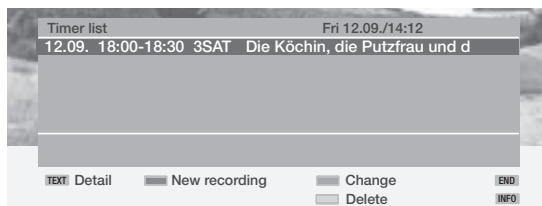

Select picture format



The TV set sets the best picture format automatically when Auto format is switched on. If you want to set a different format, press this button until the desired format is selected or select the format with ◀ ▶.



You can switch the panorama picture over to distortion-free representation on your TV set. Dark margins are then visible on the left and right of the picture.

Switching over: Keep the ⏻ button on the set pressed, at the same time press the "Picture format" button on the remote control briefly.

Resetting: Press the same button combination again.

Move picture up/down



To make picture subtitles visible, you can use ▲ ▼ to move the picture up or down with the picture formats "Panorama", "Cinema" and "Zoom".

Note: for DVB-T stations in GB you can switch back and forth quickly between two stations using this button.

TV menu



Call up the TV menu

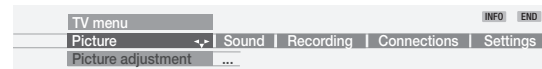

You will find a description of the picture and sound settings on page 17. The TV menu offers other options for recording, connections and settings of the TV set.

For a recorder that is logged in, you can find the following menus in the "Recording":

[Recording wizard - to programme new timer recordings](#)

• Via EPG • Via teletext • Manual

You will find further information about timer recording on page 30.

[Timer list](#)

Here you will find a list of programmes programmed for recording. You can change the recording data or delete programmed recordings and programme new recordings.

[Pre-record time and Post record time](#)

For recordings without VPS/PDC, set a lead and lag time here so that the programme is fully recorded despite any slight differences in the time.

Under "Connections" you will find the following functions:

[New devices/modifications \(connection wizard\)](#)

The connection wizard helps you connect and log in additional equipment such as video recorders, DVD players/recorders, camcorders/digital cameras, pay TV decoders, equipment with component signals and digital HDMI/DVI signals.

[Antenna DVB \(only for sets with DVB\)](#)

• Antenna DVB-T • Antenna DVB-S ⁽¹⁾

You can find more information on pages 11 and 12.

[Digital Link Plus](#)

Transmission of the station data from the TV set to the video/DVD recorder if a recorder with Digital Link Plus is connected.

[Miscellaneous \(connections\)](#)

- Set AV norm for the connections manually (if it is not recognised automatically).
- "Assign audio digital signals" to one of the AV sockets.
- "Allow switching voltage" to display the signals of the connected device immediately on the screen via Euro AV during playback.
- RGB insertions at AV2 to play back RGB signals at all station storage locations.
- Select decoder stations and set sound encoding.

⁽¹⁾ only for sets with DVB-S

Operating modes – TV

Under “Settings” you will find the following functions:

Stations

Here you can search for and store new stations automatically or manually. With “Change stations”, you can rearrange and delete the stations and change station names (not for DVB-T stations in GB).

- Search wizard
- Manual adjustment
- Change stations

Parental lock

You can lock the TV “immediately”, “daily” for a certain period of time or “age-related” for DVB programmes with age restrictions.

Here, you determine the PIN to enter if you want to watch locked programmes.

Timer functions

You can have your TV switch off at pre-programmed times or wake you/remind you with radio or TV. If you are not present at the time, a safety prompt makes sure the TV switches off again after 5 minutes.

- Switch off today only
- Switch off daily
- One-time reminder
- Wake up Mon-Fri
- Wake up Sat
- Wake up Sun
- Wake up with *
- Wake up signal volume

Language

If “your” menu language is not set, you have to select the “Language” menu in a language that you do not understand. Therefore here is a simple way to set the right menu language:

1. Press the **INFO** button (index), select the first listing (this is above A).
2. Call the language selection by pressing the **OK** button.
3. Now select the desired language and confirm it by pressing the **OK** key.
4. Hide the menu again with the **END** button.

Miscellaneous (settings)

On-screen displays

You can set the duration and position of the station and status display, define the content of the status display and switch the automatic info texts on or off:

- On-screen display time
- On-screen display position
- Programme title
- Sound mode
- Time
- Alarm time
- Sleep timer
- Automatic info

Time and date

If you receive teletext, the set registers the time and date. These are required for timer recordings, timer functions and EPG. If you do not receive teletext, then you have to enter the date and time; you should not switch off the set using the mains switch since the settings will then be lost.

DVB software*

Update of DVB software via satellite ⁽¹⁾.

DVB subtitles*

- Subtitles off
- Subtitles for the Hearing Impaired
- Subtitles as translation for foreign language programmes

DVB character set*

- Western European
- Polish
- Standard.

DVB subtitles

If the station provides DVB subtitles, then you can have the TV display them permanently or suppress their display. You can also select between subtitles “for translation” or “for the Hearing Impaired”.

1. Call the “TV menu” via the **MENU** button.
2. Select the “Settings” line and confirm using **OK**.
3. Select the “Miscellaneous” line and confirm using **OK**.
4. Select the “DVB subtitles” line and confirm using **OK**.



Note: If you have selected “Subtitles off”, then the set generates an on-screen display when subtitles are available.

By using the **END** button, you can open the status display and you can display the subtitles again by using the **TEXT** button.

- Call the status display by pressing the **END** button, if it is not yet displayed.
- When the status display is visible, press the **TEXT** button. Select the desired language and confirm using **OK**. The presetting changes for the current programme.
- Which subtitle languages can be selected depends on the provider.
- The automatic shortlist is determined by the menu language and the selection made in the “DVB subtitles” settings menu.
- By pressing the **END** button, you can hide the menu again.

Note: DVB subtitles are not available when Digital Teletext is being displayed.

⁽¹⁾ only for sets with DVB-S.

Operating modes – TV

Removing the CA module

(Only for sets with CI slot)

1. Switch the TV set off with the mains switch.
2. Remove the cover from the back of the set on the upper left.
3. Press the eject button at the module slot; the CA module is unlocked.
4. Remove the CA module from the set.

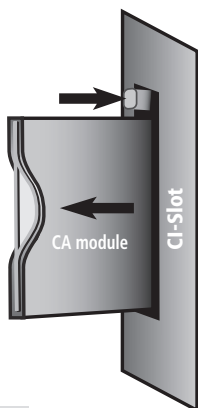

Inserting a new CA module

After you insert a new CA module (CI module¹) is displayed in the menu) and switch the TV set on, the following dialogue is displayed:

Autom. station search

Your TV set has detected a new CI module. This requires a station search for all new receivable stations.

After you press the **OK** button, the system starts the wizard to carry out the automatic station search. Check the proposed search parameters and let the set search for new stations.

Calling the CA module menu

Here you can call up information on the inserted Conditional Access module and the Smart Card. To do this, use the **MENU** button to call the TV menu, select the line "Settings", "Miscellaneous" and then the entry "CI module - xxx" (in place of "xxx" stands the name of the provider which is output by the Smart Card. The term CI module¹ displayed in the menu refers to the CA module. The content of this menu depends on the particular supplier of the CA module.

Note: This menu is only available for digital stations.

Installing new DVB software

To ensure your DVB-S receiver is always performing at the state of the art, newly developed software versions are made available from time to time; these are broadcast via satellite and can be automatically installed on your set (only possible via ASTRA1).

Software is recognised automatically

The set can determine whether a new software version is available. This occurs at night when your EPG is automatically updated. For this, your TV set has to remain in the standby mode (do not switch off using the on/off button on the set). If a new software version has been found, the set will indicate this with an on-screen message the next time the set is switched on: You can decide whether or not you want to download the new software.

Confirm using **OK**, so that the new software can be loaded and installed via satellite. Continue as set out in the "Downloading software" section.

Searching for new software

If you want to carry out a manual search for new software, proceed as follows:

1. Call the TV menu using the **MENU** button.
2. Confirm the "Settings" using **OK**.
3. Confirm the "Miscellaneous" using **OK**.
4. Select "DVB software" and press **OK**.

Update digital TV software

Current version: V3.x.x

You can search for a new software version with **OK**.

5. If you start the search using **OK**, the set checks if there is a new software version available.
6. If there is a new version available, the set generates an on-screen message.

Update digital TV software

Current version: V3.x.x

New version: V3.1.0

Downloading software

1. If you press **OK** in the dialogue above, you can decide whether you want to download the new software immediately, when you switch off the set or not at all. We recommend you always carry out the update of the digital software. This is the only way to ensure your set is always up to date.
2. If you do decide to update, the software is initialised on your set and you are informed of the status with a grey bar.
Do not switch your set off during this time. This process may take up to one hour. You will be informed when the process is completed.
3. After the software is updated, you will be asked to switch your TV set off and back on again using the on/standby switch.

If the update was not carried out, you will be asked several times when you switch on the set whether you want to carry out this update.

¹ CA module has established itself as the usual market name. This cannot be taken into consideration in the menu yet

Operating modes – PIP

Picture in picture (PIP)

Note: The coloured keys do not work as described below with DVB-T stations in GB, but they operate as described on page 27 (Digital Teletext).

Picture in picture displays are possible if the set has an analogue PIP tuner or a digital satellite tuner in addition to the analogue TV cable tuner. You can have a PIP tuner or a digital satellite tuner retrofitted. Set-specific equipment and retrofitting options for CI-Slot, PIP and satellite tuners, see pages 41 and 42. If there is no other tuner installed, you can use PIP (AV-PIP) when playing a video recorder or DVD player. For a retrofitted PIP tuner, the following PIP displays are possible: Main picture analogue – PIP picture analogue, Main picture digital – PIP picture analogue. The following is not possible: Main picture digital – PIP picture digital, Main picture analogue – PIP picture digital.

For "Split screen," the PIP picture is displayed on the right side of the screen. Both pictures share the screen in two equal halves. For the "Small PIP" setting, a small picture is displayed in the TV picture. The green bar/frame indicates that the control commands have an effect on the PIP picture. The white bar/frame means that the control commands have an effect on the main picture. Use the **green** coloured key to switch between the PIP picture and the main picture, for example to change stations. The frame or bar between the pictures is green for the time being.

 # PIP Show/hide PIP picture

PIP picture as freeze picture

 The bar/frame has to be green. If not, press the **green** coloured key. If you press the **red** coloured key, the PIP picture freezes. Press again - moving picture.

Selecting the station of the PIP picture

 The bar/frame has to be green. If not, press the **green** coloured key. Then select the station as usual.

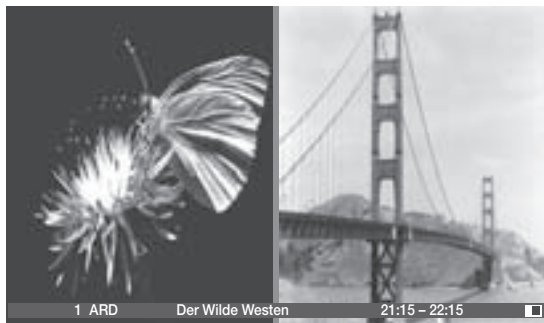

Select the station of the TV picture (main picture)

 The bar/frame has to be white. If not, press the **green** coloured key. Then select the station as usual.

Note: For GB sets, you switch from the green bar/frame to the white by using the **PIP** key. The next time you press the **PIP** key, PIP is switched off.



PIP scan in the PIP picture

 The bar/frame has to be green. If not, press the **green** coloured key. Start scanning the stations using the **blue** coloured key. The bar/frame turns blue.

The stations now change automatically. Stop scanning the stations by using the **blue** coloured key. The bar/frame turns green again.

Interchanging PIP picture/TV picture

 The bar/frame has to be green. If not, press the **green** coloured key. Interchange the pictures by using the **yellow** coloured key.



Operating modes – PIP

Functions in the PIP menu

In the PIP menu, you can set the PIP type (small picture or split screen) and the position of the small picture.

 Call the PIP menu (PIP must be active, green bar/frame).

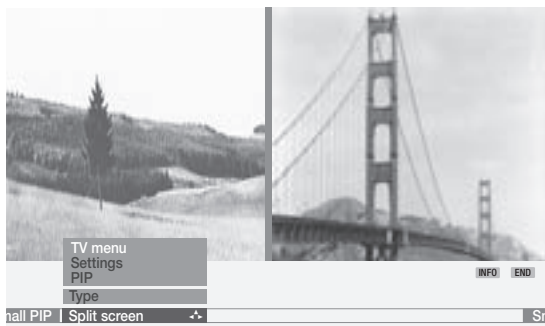

Setting the PIP type

You can have the PIP picture displayed as a small PIP or split screen.

Switch to small PIP:



Select "Type" and then "Small PIP"



For the small PIP, you will see a coloured frame around the PIP picture.

Position of the PIP picture



Move the PIP picture with the arrow keys to a corner of the TV picture. In this case, the frame around the PIP picture has to be green, and there should not be any other displays visible on the screen.



Switch to split screen:

You can have the PIP picture displayed on the right hand side of the screen. Both pictures share the screen in two equal halves. You will see a coloured vertical bar between the pictures.



Call the PIP menu (PIP must be active, green frame).



Select "Type" and then "Split Screen".

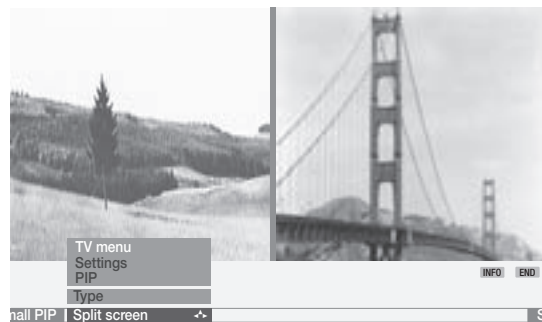

Operating modes – EPG

EPG - Programme guide

EPG is an electronic programme guide. With this system, you can easily find the programmes that interest you (sorted according to day, time, stations and topics). You can mark programmes and programme recordings.

Depending on whether you are receiving analogue stations by cable/antenna or digital stations, you will have different programme guides.

A wizard is activated the first time you use EPG (not with DVB) which guides you through the necessary settings. Then run the data capture (see next page).

Using the EPG

★ EPG

Switch EPG on/off

The screenshot shows the EPG menu with the following settings:

- Date: Fri 10.09.
- Time: now
- Stations: all
- Topics: all

The programme list is displayed below, with the following entries:

| Time | Station | Programme |
|-------------|-----------|-----------------------------|
| 13:20-14:15 | Kabel 1 | Die Waltons |
| 13:30-14:15 | H3 | ARD-Buffer |
| 13:55-14:20 | Kinderkan | Blaubär & Blöd (37) |
| 14:00-14:15 | ZDF | heute - in Deutschland |
| 14:00-15:00 | RTL | Das Strafgericht |
| 14:00-15:00 | Sat 1 | Zwei bei Kallwass |
| 14:00-15:00 | Pro7 | Das Geständnis - Heute s... |
| 14:00-14:30 | N3 | DAS! ab 2 |
| 14:00-14:20 | WDR | Die kleinen Strolche (10) |
| | | Familienserie - Sturzflug |

At the bottom, there are buttons for TEXT, Detail, View, Record, and END, along with a numeric keypad for selecting time and topics.

The programme guide menu is divided into two areas: at the top, you can make the settings for the programme list (date, ..., topics); on the bottom, the programme list is displayed. Use the **blue** coloured key to switch between the two areas to make your selections.

All programmes **currently** running are listed initially in the programme list. With the **▼ ▲** buttons, select the programme you want to watch and switch over with the **OK** button.

Brief information is shown below the programme list for some programmes. If more detailed information is available, you can call it using the **TEXT** button.

Use **P+/P-** to scroll up or down through the pages of the programme guide. In the selection lines for date and time above, you will see the time change when scrolling; when you scroll further, the date also changes.

When the "Time" line is selected, you can enter the time as of which the programmes are to be displayed; use the numeric buttons on your remote control to do this. Always enter four digits, such as 0900 for 9 a.m.

If programmes are displayed which have not yet started, you can mark these with the **OK** button. The TV set then switches automatically to this station at the given time. When receiving digital terrestrial and digital satellite stations, you may find that two identical EPG data are displayed in the "EPG (DVB)" menu for one station. If you call the EPG menu in the EPG mode by using the **MENU** button, then select "Station selection," you can select the duplicate station and deactivate it by using **OK**.

You have direct access to the selection lines above to pre-select the day, the time, the station and the topic.

 **Blue** coloured key: Call Select date/time/stations/topics

The screenshot shows the EPG menu with the following settings:

- Date: Sat 11.09.
- Time: 06:00
- Stations: all
- Topics: all

The programme list is displayed below, with the following entries:

| Time | Station | Programme |
|-------------|-----------|---|
| 06:00-06:20 | ZDF | Die Blobs |
| 06:00-06:30 | RTL | Wunderbare Jahre |
| 06:00-06:25 | Kabel 1 | Dennis |
| 06:00-06:25 | N3 | Extra en español (5) |
| 06:00-06:30 | BR | Goal. Speak English, Play Football |
| 06:00-06:30 | WDR | Lokalzeit Südwestfalen |
| 06:00-07:10 | SuperRTL | Infomercials |
| 06:00-07:10 | Kinderkan | Reif für die Dodo-Insel (25) |
| 14:00-14:20 | 9LIVE | Reisetraum |
| | | Comedyserie - Kandidaten mit gewissen Fehlern |

At the bottom, there are buttons for END and Change to programme list.

Use **▼ ▲** to select the menu line for the date, time, stations or topics. Use **◀ ▶** to select within the menu line.

If, for example, you are looking for the next news, select today's date, "Soon" under Time, "All" under Stations and "News" under Topics.

Then you get a list of all news programmes in the programme list below.

The screenshot shows the EPG menu with the following settings:

- Date: Fri 10.09.
- Time: soon
- Stations: all
- Topics: News

The programme list is displayed below, with the following entries:

| Time | Station | Programme |
|-------------|-----------|---------------------------|
| 15:00-15:15 | Das Erste | Tagesschau um drei |
| 15:00-15:05 | hr-fernse | hessen aktuell |
| 15:00-15:15 | ZDF | heute - Sport |
| 16:00-16:05 | SÜDWEST | Baden-Württemberg Aktuell |
| 16:00-16:15 | Das Erste | Tagesschau um vier |

At the bottom, there are buttons for END and Change to programme list.

If you want to mark one of these news programmes, return to the programme list using the **blue** coloured key, select the desired news programme by using **▼ ▲** and mark this by using **OK**.

Operating modes – EPG

In front of the programme's title, the system places an . This station is switched later to this programme when the set is switched on. If the TV is off, it switches on again automatically at the beginning of the marked programme if this has been set in the EPG menu. If you are out, a security prompt prevents the TV set staying on unattended.

Before leaving the upper selection lines using the **blue** coloured key, select a specific line. If you have switched back to the programme list, you can change this menu line using **◀ ▶** without having to leave the programme list.

Programming recording for recorders

The programme marked using the **▼ ▲** buttons can be prepared for recording by pressing the **red** coloured key. In the following menu, confirm the timer data or change them as required. Then, a red dot is set in front of this programme in the EPG programme list as an identification (if timer data is being transferred to the recorder, no red dot is set). If you select this programme, you can delete it from the timer using the red coloured key (if the timer data has been transferred to a recorder, the timer has to be deleted there).

EPG menu



Call EPG menu

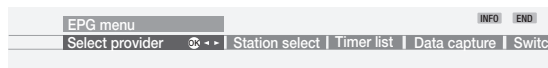

You will find the following settings in the EPG menu:

- Select provider
- Station selection
- Timer list
- Data capture
- Switch on TV when marked

Selecting providers and stations

If you want to change the provider for analogue TV reception (the station which transmits EPG data) to have other stations evaluated, you can do this under "Select provider".

Select "Select provider" and call this menu using **OK**. If the station you want to switch to is not listed in the "Select provider" list, then use the **yellow** coloured key to start the automatic search for stations with EPG data. This takes a while.

Or, if you know the station that transmits EPG data, press the **blue** coloured key to compile manually. Select the provider in the station list and adopt it by using **OK** and return to the provider selection using **◀◀**.

Select the provider in "Select provider" and adopt it using **OK**. Then a station list search is performed. The stations offered by the provider are displayed in a list.

If you want certain stations to be omitted from the programme guide, you can select and deactivate these via **Station selection**. Call the station selection by using the **blue** coloured key.

First, all stations are marked with the  symbol so that their data is displayed in the programme guide (precondition: provided EPG data is broadcast for the respective station). Stations indicated by **E** are analogue terrestrial/cable stations, stations indicated by **T** are DVB-T stations, stations indicated by **C** are DVB-C stations and stations indicated by **S** are DVB-S stations. These stations are available for evaluation in the programme guide.

Select the stations you want to omit from the programme guide one after another and deactivate each one by using **OK**. The  symbol is removed.

Data capture

After these settings or after each time the set is switched off using the mains switch, the data must first be collected, before switching on the set.

To do this, select the station you have defined as a provider and leave the TV set switched on for about one hour or switch the set to the standby mode. After about two minutes in standby mode, the indicator on the set turns orange. The data acquisition begins and lasts about 1 hour. When data acquisition is terminated, the indicator turns red again. The data are also automatically captured between 2 a.m. and 5 a.m. when the TV is switched to standby.

A prerequisite for data capture is that "Data capture" is "on" (for DVB + analogue) in the EPG menu.

Note: If the TV set is switched off using the mains switch or the mains plug is pulled out, all EPG data are lost.

If, for example, you cannot receive any analogue EPG providers or if you only use DVB, you should set the data capture to "on (only for DVB)".

Switch on TV when marked

You can have the TV switched on automatically from standby at the beginning of the marked programme. If you are not present at the time, a safety prompt makes sure the TV switches off again after 5 minutes.

Operating modes – Teletext

Analogue Teletext

Teletext transmits information such as news, weather, sports, programme previews and subtitles.

TEXT

Teletext on/off

| | | | | |
|-----|-----|---|------------------|-------------|
| 100 | 100 | ARD-Text | 10.09.04 | 14:14:42 |
| | | ARD TEXT | | Index > 101 |
| | | Teletext im Ersten | | |
| | | Bulmahn: Bildung statt Eigenheim | | 120 |
| | | Wird auch der Nahverkehr teurer? | | 121 |
| | | Australien: Keine Zugeständnisse | | 122 |
| | | Tote bei Zugangslück in Schweden | | 532 |
| | | Tennis: Haas unterliegt Hewitt | | 204 |
| | | Formel 1: Schumacher erneut vorne | | 213 |
| | | Tagesschau .. 110/112 | Kultur | 500 |
| | | Wetter | Gesellschaft .. | 530 |
| | | Sport | Lotto/Toto .. | 666 |
| | | TV Guide | Wirtschaft | 700 |
| | | Internet: www.ard-text.de | | |
| | | | Inhalt | tagesschau |
| | | Page selection | | |

Many stations use the TOP operating system, some use FLOF (e.g. CNN). Your TV supports both these systems. The pages are divided into topic groups and topics. After switching on the teletext, up to 1,500 pages, depending on type of set are stored for fast access (see technical data on page 40).

Page selection with the coloured keys

The coloured bars (in TOP) or the coloured writing (in FLOF) in the next to the last line show you which coloured keys you can use to scroll to topic groups and topics.



Red: back to the previously seen page (not in FLOF)

Green: on to the next page (not in FLOF)

Yellow: to the next topic (only in TOP and FLOF)

Blue: to the next topic group (only in TOP and FLOF)

Other page selection options:



Select one page number specified on the page by using
 ▼ ▲ (Page Catching)

| | | | |
|---|--------------|------------------|------------|
| Formel 1: Schumacher erneut vorne | 213 | | |
| Tagesschau .. 110/112 | Kultur | 500 | |
| Wetter | 170 | Gesellschaft .. | 530 |
| Sport | 200/600 | Lotto/Toto .. | 666 |
| TV Guide | 300/400 | Wirtschaft | 700 |
| Internet: www.ard-text.de | | | |
| | | Inhalt | tagesschau |
| | | Page selection | OK View |



call.



In **Multiple pages** scroll using ◀ ▶. You can see which multiples pages can be called in the bottom menu line.

| | | | | |
|--|--|--|----------|---------|
| | | | Zeitplan | Fußball |
| | | | 1 | 2 |
| | | | 3 | 4 |
| | | | 5 | 6 |
| | | | 7 | 8 |
| | | | 9 | 10 |
| | | | 11 | 12 |

INFO

Call **contents page 100**



Call the **TOP table**

The TOP table is a general list of teletext. You can only call the table for stations that use the TOP operating system.

| | |
|--|-----|
| Bulmahn: Bildung statt Eigenheim | 120 |
| Wird auch der Nahverkehr teurer? | 121 |
| TOP table | 122 |
| Übersicht | 532 |
| Wetter | |
| Vorhersage .. | 204 |
| Städte .. | 213 |
| Regional | |
| Reisen | |
| int. Städte .. | 500 |
| Biowetter .. | 530 |
| 666 | |
| more ... | |
| OK View | |

Use ▼ ▲ to select the topic group.

Select the topic column using ▶.

Select the topic with ▼ ▲ and display page with **OK**.

1 2 7 pqrs

Enter the page number directly

Displaying teletext pages

0 AV

Stop self-turning pages (HOLD)

9 wxyz

Zoom page: top part - bottom part - normal size (press button several times)

PIP

TV picture on/off (Split Text)

| | | | | |
|-----|-----|---|------------------|-------------|
| 100 | 100 | ARD-Text | 10.09.04 | 14:14:42 |
| | | ARD TEXT | | Index > 101 |
| | | Teletext im Ersten | | |
| | | Bulmahn: Bildung statt Eigenheim | | 120 |
| | | Wird auch der Nahverkehr teurer? | | 121 |
| | | Australien: Keine Zugeständnisse | | 122 |
| | | Tote bei Zugangslück in Schweden | | 532 |
| | | Tennis: Haas unterliegt Hewitt | | 204 |
| | | Formel 1: Schumacher erneut vorne | | 213 |
| | | Tagesschau .. 110/112 | Kultur | 500 |
| | | Wetter | Gesellschaft .. | 530 |
| | | Sport | Lotto/Toto .. | 666 |
| | | TV Guide | Wirtschaft | 700 |
| | | Internet: www.ard-text.de | | |
| | | | Inhalt | tagesschau |
| | | Page selection | | |

Operating modes – Teletext

Programme timer recordings

A video and/or DVD recorder must be connected and logged in in the connection wizard. Call the programme pages of the current station in teletext mode using the Direct recording button . Scroll to the teletext page in which the programme to be recorded is listed if necessary. Select the programme you want to record by with \blacktriangledown \blacktriangle and confirm with the **OK** button. For "Timer data," select the VCR or DVD recorder and whether you want to record once or a series of times. Confirm with **OK**.

Teletext menu



Display teletext menu



Here you will find functions such as

- "Newsflash", this is an on-screen display of the latest messages (e.g. page 111).
- "Reveal" concealed information, e.g. VPS pages in the station preview pages.
- Programme wizard for recording via teletext.

In the settings, you will find menus to define the station preview pages, subtitle pages and personal text pages, and menus to set the character set selection as well as HiText graphics.

Digital teletext operation (only for MHEG-5 device versions)

In the GB, the teletext for DVB-T stations is transmitted as per the MHEG-5 standard (standard of the Multimedia and Hypermedia Expert Group). It contains text, graphics, functions and links.

The operation of these menus depends on the particular provider. Normally after a station is changed, the provider broadcasting the digital teletext makes an introductory offer for this service on the screen via menu selection. Follow these notes.

If no message appears telling you how to switch to digital teletext after switching to another station, press the **TEXT** key. If a selection for DVB subtitles is available, this item must be hidden before.



Depending on the provider's respective offer, you can use the \blacktriangledown \blacktriangle \blacktriangleleft \blacktriangleright buttons and the **OK** button, the **coloured keys**, the **END/TEXT** button and sometimes even the **numeric buttons**.

If you want to close the digital teletext, just select a different station using the **P+/P-** buttons or follow the menu prompts on the screen.

Note:

- Digital teletext is not available when DVB-subtitles are being displayed.
- If a timer recording is programmed at the TV-set, at the start time of the recording the digital teletext mode is switched off automatically.

Operating modes – Radio

Radio

You can only receive radio stations via DVB. If you do not have any DVB radio reception, you can play a sound signal from an external device using the TV set via the sound/AV inputs.

RADIO

Use the **RADIO** button on the remote control to switch the radio on or off.

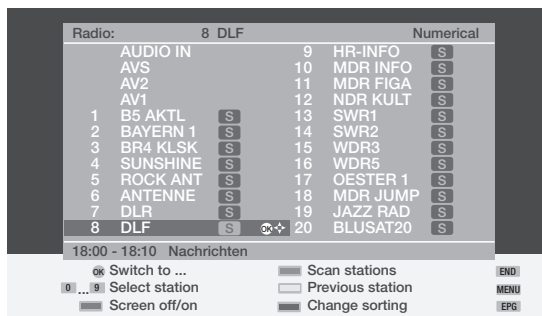

You can see a station list of the radio stations or with DVB-T in GB the station logo. In this case you can call up the station list by using the **OK** or **INFO** key. Station list is sorted by LCN.

You can see a station list of the radio stations. Digital DVB-T stations are indicated by **T**, DVB-C stations by **C** and DVB-S stations by **S**. Encrypted stations are additionally indicated by . Ask your specialist dealer about decoders or the use of a CA module and a Smart Card for the reception of encrypted stations.

When time and title are sent by the marked station these data are displayed at the bottom of the station list.

When the station list is shown you can switch off the screen with the **red** coloured key. The LED indicator on the set changes from green to orange. You can switch the screen display back on by using the **OK** key, **red** or **blue** coloured keys, by using **RADIO**, **MENU** or **END** on the remote control.

Station switching with dark screen: by using **-** or **+** on the TV set or by using the remote control **P-** and **P+** or by using the numeric buttons (for DVB-T operation in GB, the buttons may be configured differently by the provider).

The sound menu can be called in the radio mode using the button.

Radio menu

MENU

Call radio menu

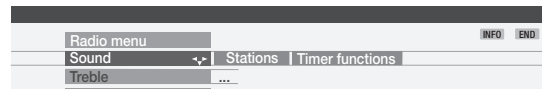

In the radio menu, as in TV mode, you can set the sound, search for radio stations and store them (automatically or manually – not with DVB-T mode in GB), delete stations from the list, rearrange them or change names and set the switching off and alarm functions.

EPG - Programme guide

For the DVB radio stations, you can also use the programme guide if the station currently active supplies data.





*** EPG**

Call Programme guide

Operating additional equipment

Login and connect equipment

You have logged in and connected all connected equipment in the initial installation. If you want to connect other equipment or disconnect equipment, call the connection wizard.

-  Call up the TV menu
-  Select "Connections"
-  Select the submenu line
-  Select "New devices/modifications" and ...
-  Call with OK.

State what equipment you want to connect. State whether a piece of audio equipment is to be connected (more details as of page 31). The connection wizard then shows you which sockets you should connect this equipment to. Then connect the equipment to these sockets according to the connection diagram.

Connecting video/DVD recorders

In addition to the connection via the Euro-AV sockets, you also have to connect the antenna (only for terrestrial antenna or cable systems) through the VCR/DVD recorder to the TV set. The antenna signal is then available to the video/DVD recorder and the TV set.

Note: Use Euro-AV cables with right-angled plugs as shown.

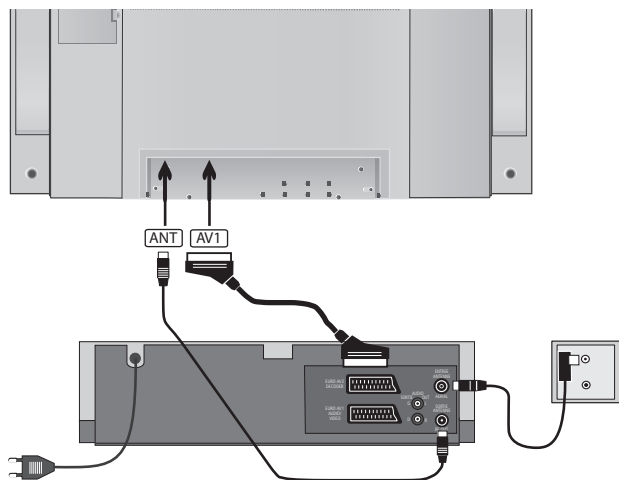

Search for and store the station of the video recorder (if no Euro-AV cable is available)

Switch on the test station on the VCR or insert a recorded tape and start playback. In some video recorders the station must be switched on by activating the modulator.

Then call the AV selection on the TV set with **0 AV**. Select the menu item "VIDEO" in the AV selection and call using **OK**.

To prevent "normal" TV stations being found in the search, pull out the antenna plug from the antenna input of the VCR temporarily (the cable to the antenna system).

If you cannot see the test station or playback from the cassette, the VCR is transmitting on a different channel. You then have to search for the station or set it manually.

1. Call the TV menu with the **MENU** button.
2. Select the "Settings" menu item with **◀ ▶**.
3. Select the line below using **▼** and use **◀ ▶** to select "Stations".
4. Select the line below using **▼** and select "Manual adjustment" using **◀ ▶** and call this menu using **OK**.
5. Enter channel "E30" under the "Channel" menu item ("Antenna/cable (analogue)", select in this menu above if necessary).
6. Start search with the **blue** coloured key.
7. When the station has been found, change the name if needed, confirm with **OK** and save with the **red** coloured key.
8. A list of the stored stations is displayed.
9. Select 0 (VIDEO) here and overwrite this station storage location using the **red** coloured key.
10. Hide the menu again using the **END** button.

Plug the antenna plug back in.

If you now get interference because a TV station is transmitting on the same channel as the VCR station, you have to change the transmitting station on the VCR and search for the VCR station on the TV again.

Operating additional equipment

Video playback

There are several ways to see the picture and hear the sound of the VCR, DVD player/recorder or camcorder on your TV:

1. You can usually use the Euro-AV sockets on the TV set and on the VCR. For camcorders or digital cameras, use the AVS sockets on the TV set. DVD players/recorders and SetTopBoxes may have HDMI or component sockets for video and audio transmission. In this case, use the corresponding sockets on the TV set.

When playing back from a video recorder using Euro-AV socket and Digital Link Plus (or a comparable system from another manufacturer), the picture from the VCR is shown at the current channel location.

When playing back from another VCR, camcorder or digital camera, use the AV selection  or the station list (OK) to select the AV socket/the device to which the VCR is connected.

Video recorders transmit a switching voltage during playback, which the TV can evaluate (can be activated in the connection wizard or in the "TV menu – Connections – Miscellaneous – Allow switching voltage" - set to "yes"). Then the picture of the video recorder is shown during playback at the current station location.

2. You can use the antenna connection between the VCR and the TV without a Euro-AV socket. The sound is only transmitted in mono. Select the first menu item, e.g. VIDEO, in the AV selection.

Calling AV inputs in the AV selection:



Call AV selection



Select AV device/socket (or VIDEO if the video recorder has been connected only via the antenna socket) and use ...



to call.

Now you will see the playback from the connected AV device.

Calling AV input via the station list

Call the station list with the OK button in TV mode.

In the numeric and alphabetical sorting, you will always find the AV sockets at the top of the list.

Timer recording with video or DVD recorder

You can programme timer recordings on the TV set. Programming can be done with the EPG programme guide (not with DVB-T in GB), teletext or manually. Call the "Timer list" menu with the  button and press the red coloured key for the "Recording wizard". Select whether you want to programme the recording via EPG, teletext or manually. You also have the option to programme recordings directly from the EPG programme guide or teletext.

Note: Copy-protected programmes are not output to the Euro-AV sockets for legal reasons.

When you have connected the Euro-AV socket to a recorder which has **Digital Link Plus** or a comparable system from a different manufacturer, the timer data of analogue terrestrial stations are transmitted from the TV to the recorder. The recording quality SQ or EQ is transmitted for DVD recorders, in addition to the station, date and time. The recording is then controlled by the recorder and the recorder tuner is used for reception of the station. The recording data are not saved in the timer list of the TV set. You will only find the timer data in the recorder.

If you want to record from digital stations, the TV tuner is used and the recorder is controlled by the TV set. Then the station is locked during the timer recording.

If you have connected a Loewe video recorder with **Digital Link** to the Euro-AV socket (without Digital Link Plus) and you are using the timer programming of the TV, the TV receiver is always used, for terrestrial stations as well. The TV controls the recording.

You have to set the recorder to the AV input (signal source) to which the TV set is connected.

Then the station on the TV set is locked during the timer recording.

Digital Link must be switched on on the recorder. Read the operating instructions of your Loewe recorder for more information.

Use only Euro-AV cables, which are completely wired, otherwise Digital Link/Digital Link Plus will not work.

Another advantage of Digital Link is that you can install the recorder in a concealed place (e.g. in a rack). You can control the recorder with the TV set.

If you have a Loewe recorder with both systems, you can use all the advantages. The advantages of Digital Link Plus are used for the timer recording; the advantages of Digital Link for concealed installation of the recorder.

Operating additional equipment

Assignment of digital audio inputs and outputs

Audio input "AUDIO DIGITAL IN"

The TV set has a coaxial digital audio input "AUDIO DIGITAL IN" and a coaxial digital audio output "AUDIO DIGITAL OUT". If you are using an external digital surround amplifier for sound reproduction, you have to feed digital audio signals to the TV, e.g. from the DVD player.

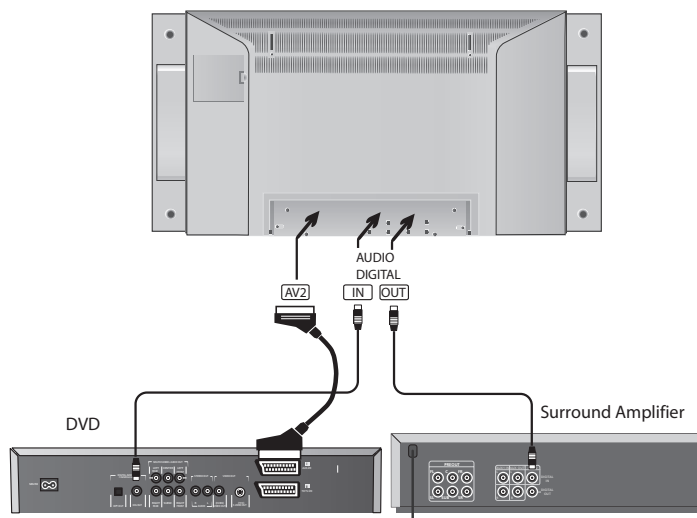

Connect the output socket of the DVD player (DIG OUT) to the TV's "AUDIO DIGITAL IN" socket with a cinch cable.

In the connection wizard, specify that audio transmission is to be digital. Specify that the digital sound is to be assigned for example to the Euro-AV socket 2 to feed the digital sound to the digital audio output of the TV set and via this to the external audio amplifier. Further information about this can be found on page 33.

Audio output "AUDIO DIGITAL OUT"

The digital audio signal is applied at the "AUDIO DIGITAL OUT" socket of the TV. For example, you can connect an external digital audio amplifier or the Loewe Auro system here.

An analogue audio signal from the TV set or another sound source which is received at one of the Euro-AV sockets of the TV set is converted into a digital signal (PCM) and output at the "AUDIO DIGITAL OUT" socket. Conversion from external analogue AV sources to PCM is not possible if the TV's loudspeakers are used as a centre channel. In this case, connect your audio amplifier additionally to the TV (AUDIO OUT L/R) with a cinch cable and switch the audio amplifier to analogue audio input.

The digital TV sound or the digital sound of a connected auxiliary device is only audible via an external digital audio amplifier (e.g. Loewe Auro system).

Operating additional equipment

Connecting Loewe DVD Preceiver Auro 2216 PS and Individual Sound loudspeaker system

You can play audio signals from the TV or DVD player in cinema quality with these components. In addition to the subwoofer illustrated below the Individual Sound system includes up to 5 loudspeakers for the front, center and surround reproduction. The centre signal can be reproduced alternatively by the TV speakers. Connect the cubic socket on the DVD Preceiver to the "Master" cubic socket on the subwoofer. Use the cubic plug cable enclosed with the DVD Preceiver. Plug the white plug (without kink protection) into the cubic socket on the subwoofer. For TV as a centre loudspeaker, connect "AUDIO IN C" on the TV set to "PRE OUT C" on the DVD Preceiver using a cinch cable.

Connect the digital audio output of the TV set "AUDIO DIGITAL OUT" to the "DIGITAL IN" input of the Preceiver using a cinch cable. Connect the TV socket "SERVICE" to the TV-L-Link socket on the Preceiver using the L-Link cable (provided with the Preceiver). Switch on the TV set and the Preceiver. Via the L-Link, the TV recognises whether the Preceiver is connected.

Select the "Tremo" loudspeaker system in the DVD menu of the Preceiver, set the listener/speaker distances and adjust the speaker levels. Please consult the Preceiver manual.

If you want to listen to the sound via the TV speakers temporarily, call the Sound menu, select "Sound via" and then "TV". If you want to listen to the sound via the Loewe Auro system, select "AURO" under "Sound via".

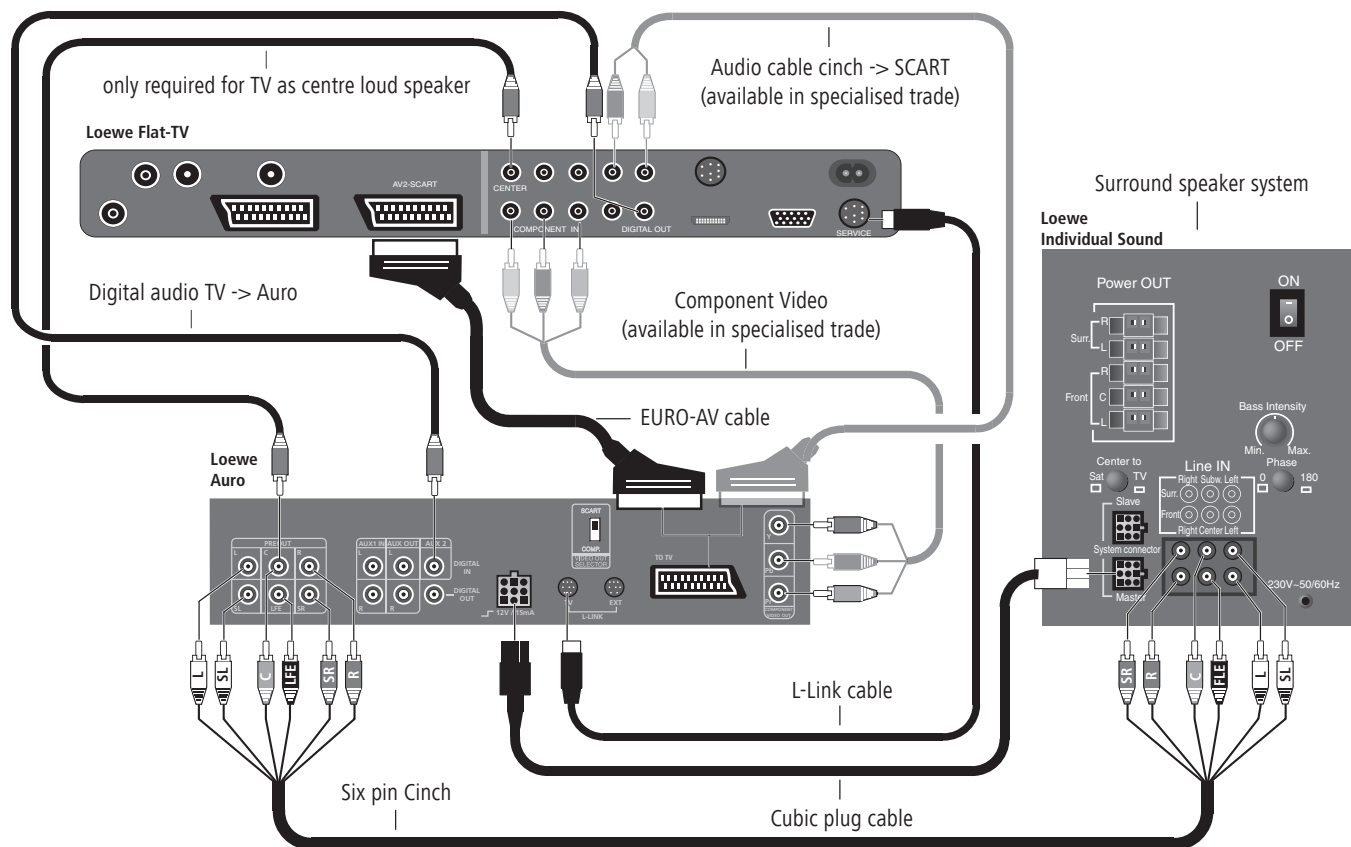

Operating additional equipment

Connecting other audio amplifiers or active speakers

In the connection wizard, select **"HiFi/AV amplifier"** under "Equipment selection: audio component". The connection wizard allows configuration of different audio amplifiers (stereo amplifiers, surround amplifiers, analogue or digital) with different sound formats (Dolby Digital, dts, MPEG and Stereo/PCM). Refer to the operating instructions for the audio amplifier to be connected.

Select **"Digital"** under "Audio transmission" for **digital audio amplifiers**. Connect the digital audio output of the TV AUDIO DIGITAL OUT to the digital audio input of the digital amplifier.

Assign the digital audio input to the socket through which the corresponding picture is transmitted (e.g. AV2 if a DVD player is connected there). Then the digital sound is passed to the digital audio output of the TV set and fed to the external audio amplifier via this.

Specify which sound formats can be decoded with your digital amplifier (Dolby Digital, MPEG, dts).

Specify under "Type of amplifier" whether the digital amplifier is a stereo or surround amplifier.

If it is a surround amplifier, specify whether or not the TV loudspeakers are to be used as centre loudspeakers. Connect the centre output of the amplifier to the centre output of the TV using a cinch cable, if necessary.

Note: do not use the centre loudspeaker connection on the amplifier; instead use the pre-amplifier centre output.

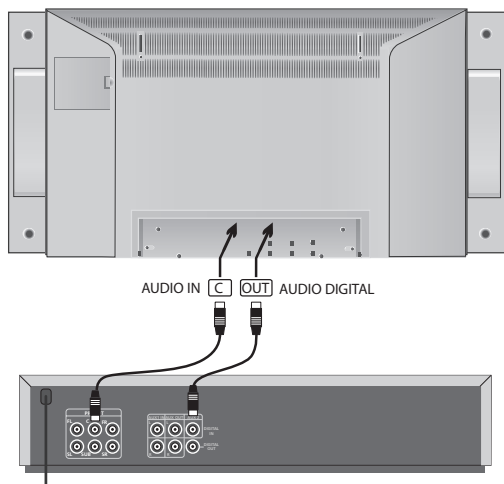

Select **"Analogue"** for "Sound transmission" for **analogue audio amplifiers**. The sound for the analogue amplifier is transmitted via the AUDIO OUT L/R connections of the TV to the audio amplifier. Connect the amplifier with two cinch cables.

Specify under "Type of amplifier" whether the analogue amplifier is a stereo or surround amplifier.

If it is a surround amplifier, also specify whether or not the TV speakers are to be used as centre loudspeakers. Connect the centre output of the amplifier to the centre output of the TV using a cinch cable, if necessary. **Note:** do not use the centre loudspeaker connection on the amplifier; instead use the pre-amplifier centre output.

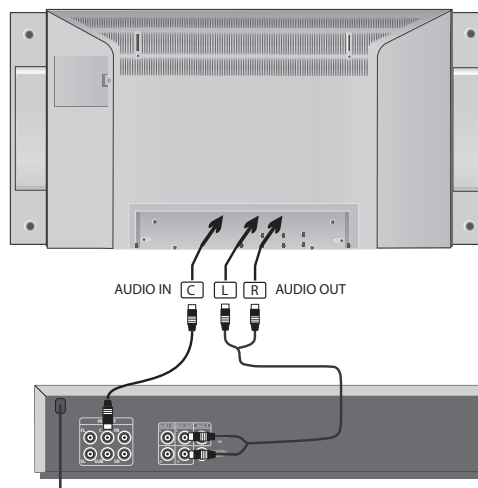

If you want to listen to the sound via the TV loudspeakers temporarily, call the Sound menu using the  button, select "Sound via" and then "TV".

When connecting **active speakers**, select "Active speakers" in the connection wizard under "Audio equipment selection". The sound for the active speakers is transmitted via the AUDIO OUT L/R connections to the active speakers. Make connections to the active speakers using the cinch cables.

Make the audio settings on the TV set when active speakers are connected. When using an external audio amplifier, make the audio settings on the audio amplifier.

Operating additional equipment

HDMI (DVI) connection



The HDMI connection (High Definition Multimedia Interface) allows digital picture and sound transmission via a connecting cable, e.g. from Loewe DVD Recorder Centros 2102/2172 HD.

The digital picture and sound data are transmitted without data compression and therefore lose none of their quality. In the equipment connected, no analogue/digital conversion is necessary, which might also have lead to losses in quality.

DVI signals can be also be reproduced by the HDMI connection using a DVI/HDMI adapter cable. This is possible because HDMI is based on DVI and is downwardly compatible. That means that the digital video signals are transmitted via HDMI - no audio signals are transmitted, though. In addition, both use the same copy protection method HDCP.

Connect the set with an HDMI connection using an HDMI cable (type A, 19-pin) to the HDMI* socket of the TV set. Log in the HDMI connection in the connection wizard (TV menu - Connections - New devices/modifications).

Select the HDMI connection in the AV selection.



Call AV selection



Select HDMI/DVI socket and use ...



to call.

Start playback on the device connected with HDMI connection.

The set automatically recognises and sets the best possible format for the video. If transmission occurs via a DVI/HDMI adapter cable, then you can feed in the appropriate analogue audio via the audio input sockets AUDIO IN L/R on the TV set. The sound is reproduced via the TV speakers.

If you have connected a digital external audio amplifier, you can select the digital audio signal in the connection wizard (TV menu - Connections - New devices/modifications) and assign it to the HDMI/DVI socket. You can make the other settings for the audio amplifier as described for digital amplifiers on page 33. The digital audio signal of the DVI audio source is fed in at the AUDIO DIGITAL IN socket on the TV. Feed the digital audio signal from the TV AUDIO DIGITAL OUT to the external amplifier.

Set geometry: as described for the VGA/XGA connection.

VGA/XGA connection



You can connect a PC or a Set Top Box (STB) and therefore use the TV screen as an output device.

Connect the PC/STB to the VGA/XGA socket on the TV using a VGA cable.

When connecting to a PC, first set one of the following screen resolutions on your PC.

800x600 60Hz (SVGA)

1024x768 60Hz (XGA).

When a Set Top Box is connected, set the following screen resolutions according to the options of the Set Top Box:

SDTV: 720x576i (PAL), 720x480i (NTSC),

720x576p, 720x480p.

HDTV: 1280x720p, 1920x1080i.

Select the VGA/XGA connection in the AV selection.



Call AV selection



Select VGA socket and use ...



to call.

Start the connected device.

Set geometry

Call the TV menu using the **MENU** button, select "Geometry" using ◀ ▶ and set:

If the picture is not positioned correctly, you can move the picture horizontally and vertically here so that it fills the whole screen. You can also set the phase position so that the picture appears in the best possible quality.

Setting colour standard

Call the Picture menu using the  button. Select "Colour standard" using ◀ ▶ and make your selection.

The colour standard for a connected PC is RGB.

In Set Top Boxes, you usually set Ycc as a colour standard. Other formats such as Ypp or RGB can also be output. Please consult the operating instructions of the device connected.

If the wrong standard is selected, you will recognise this by the wrong colours in the display.

Operating additional equipment

Sound from PC or Set Top Box

Feed the analogue audio signal from the PC or the STB to the sockets AUDIO IN L/R on the TV via a cinch cable. The sound is reproduced via the TV speakers. If you have connected a digital external audio amplifier, you can select the digital audio signal in the connection wizard (TV menu - Connections - New devices/modifications) and assign it to the VGA/XGA socket. You can make the other settings for the audio amplifier as described for digital amplifiers on page 33. The digital audio signal of the Set Top Box is fed in at the AUDIO DIGITAL IN socket on the TV. Feed the digital audio signal from the TV AUDIO DIGITAL OUT to the amplifier.

Component video connection



If you have a DVD player/recorder with Component OUT connections, you can connect it to the SD/HD-COMPONENT IN sockets of the TV instead of to the Euro-AV sockets. The connecting cable with three cinch plugs each transmits picture information.

The playback is of a better quality than via the Euro-AV socket.

You need another cinch cable for the analogue sound transmission. Connect the analogue audio outputs of the DVD player to the AUDIO IN L/R sockets on the TV set. The sound is reproduced via the TV speakers.

If you want to use the digital sound of the DVD player with a digital audio amplifier connected to the TV, make a connection between AUDIO DIG OUT of the DVD player and AUDIO DIGITAL IN of the TV set.

Log in the component/device in the connection wizard:

Assign the AUDIO DIG IN input here to the COMP. IN socket, provided a digital audio amplifier is also connected. You can make the other settings for the audio amplifier as described for digital amplifiers on page 33.

Set the signal at the component input in the connection wizard: Set to "Automatic" first. If the signal is not reproduced when playback is started, consult the operating instructions of the DVD device connected to find out what screen resolution is possible (SDTV, HDTV or ProScan).

Select the component connection in the AV selection.



Call AV selection



Select COMP. IN sockets and use ...



to call.

Start playback on the connected device.



Set geometry and colour standard: as described for the VGA/XGA connection.

Operating additional equipment

Operating Loewe video recorders and Loewe DVD players directly

You can switch over the remote control of the TV set to operate Loewe video recorders and Loewe DVD players. These devices can be operated directly.

Select the device to be operated:

-  **VCR** press the **VCR** button, the indicator above lights for about 5 seconds.
-  **DVD** press the **DVD** button, the indicator above lights for about 5 seconds.
-  **TV** Switch back to TV operation: Push the **TV** button.

Functions for Loewe video recorders (VV 8106, 8136, 8176)

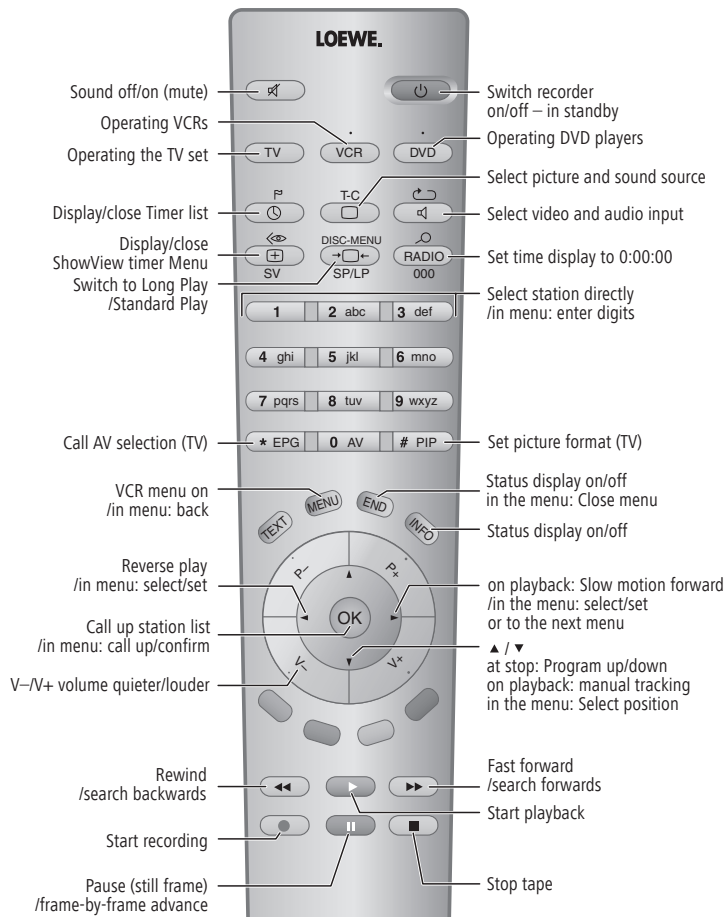

When operating in the VCR or DVD mode, the indicator above the VCR or DVD button lights up. In DVD mode, the following DVD players can be operated: Xemix 6122DO, 8122DA and 6222PS.

In VCR mode, the following VCRs can be operated: ViewVision 8106H, 8136H, 8176H, 6306H, 6336H, 6376H, 6396H, 4306H, 4376H, 2102M, 2302M, 4206, 4236, 4276.

For other Loewe equipment than that listed, please use the original remote control.

Functions for Loewe DVD players (Xemix 6122DO, 8122DA, 6222PS)

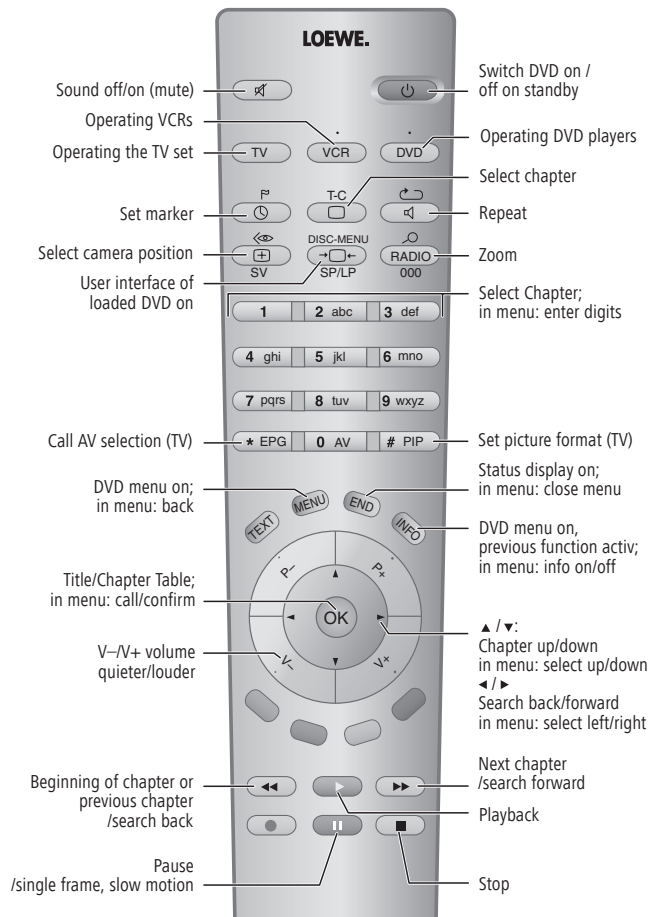

What to do, if ...

| Problem | Possible cause | Remedy |
|--|---|---|
| The "Recording" menu point is not displayed in the TV menu. | No video or DVD recorder logged in. | Log in the video or DVD recorder in the connection wizard and connect the device. |
| "Connections" cannot be called in the TV menu (deactivated). | A time recording is in progress. | Wait until the timer recording has ended or delete the timer. |
| The control of the Loewe video recorder and the timer do not work or do not work properly. | <ul style="list-style-type: none"> a) The Digital Link function is not activated or not possible in the recorder. b) Euro-AV cable is not connected. c) Recorder is not logged in. | <ul style="list-style-type: none"> a) Activate Digital Link in the recorder (see operating instructions of the video recorder). b) Connect the Euro-AV cable. c) Log in recorder. |
| General problems with connecting external equipment via an AV input. | <ul style="list-style-type: none"> a) The device is not logged in to the connection wizard or is connected differently than is shown in the connection diagram. b) The AV norm is set incorrectly. c) The AV signal is set incorrectly. | <ul style="list-style-type: none"> a) In the connection wizard (TV menu – Connections – New devices/modifications), compare the connection diagram with the actual installation and connect as shown, if necessary. b) Set the norm correctly. c) Set the AV signal correctly. <p>If "Automatic" is set for AV norm or AV signal, this can lead to errors for signals which do not conform to the norm. Then the norm and the signal are to be set according to the specifications in the operating instructions of the external device.</p> |
| A decoder connection does not function or is faulty. | <ul style="list-style-type: none"> a) The signal is not decoded because the wrong decoder stations are selected in the connection wizard. b) The sound is missing in decoder mode because the wrong decoder sound is assigned in the connection wizard. | <ul style="list-style-type: none"> a) Follow the instructions in the connection wizard again (TV menu – Connections – New devices/modifications) and select the corresponding decoder station. b) Follow the instructions in the connection wizard again and select the right audio source (decoder, TV or autom.), see instructions of the decoder. |
| All menus appear in the wrong language. | Menu language has been set incorrectly. | Set your menu language: Press the INFO button in TV mode (index). Select the first index item and call it by using OK . Then select the language and confirm with OK . |

What to do, if ...

| Problem | Possible cause | Remedy |
|---|---|--|
| Digital Link Plus does not function. | <ul style="list-style-type: none"> a) Euro-AV cable is not fully wired (pin 10 not wired). b) Some recorders can only adopt stations during the initial installation of the TV set. c) All or some of the terrestrial and cable stations are stored on station storage locations ≥ 99. | <ul style="list-style-type: none"> a) Replace the Euro-AV cable. b) Restore the recorder to the as-delivered state (see recorder's operating instructions). c) Rearrange the terrestrial and cable stations so that they fall between 1 and 99. |
| Various characters are displayed incorrectly in the teletext. | The wrong character set is set in the teletext menu. | Set the right character set: Teletext menu - Settings - Character set: standard or the appropriate character set. |
| No sound via external digital audio amplifier. | <ul style="list-style-type: none"> a) The external digital audio amplifier does not support the selected sound format (Dolby Digital, dts, MPEG). b) TV set and external digital audio amplifier are not connected. | <ul style="list-style-type: none"> a) Set PCM stereo on the DVD player in the sound selection. For DVB stations, switch language/ sound selection (green coloured key) to Stereo on the TV set in the status display (END). b) Connect Digital-Out from the TV set to a Digital-In of the external digital audio amplifier and select the appropriate input to this. |
| | | |

Technical data

General data

| Type | Concept L 26 Basic | Concept L 26 | Concept L 32 Basic | Concept L 32 |
|---|-------------------------------------|-------------------|--------------------|-------------------|
| Item no. | 65433xxx | 65421xxx | 65434xxx | 65442xxx |
| Versions TV terr. (analogue) | • | – | • | – |
| Versions DVB-T/C | – | – | – | • |
| Versions DVB-T CI (MHEG-5) | – | • | – | • |
| Versions DVB-T/C CI | – | • | – | – |
| Set dimensions without stand (ca. cm WxHxD) | 81,0x41,0x10,0 | 81,0x41,0x10,0 | 97,0x48,0x10,9 | 97,0x48,0x10,9 |
| Dimensions with stand (ca. cm WxHxD) | 81,0x47,5x23,2 | 81,0x47,5x23,2 | 97,0x54,5x23,2 | 97,0x54,5x23,2 |
| Set weight without stand (ca. kg) | 11,8 | 11,8 | 14,7 | 14,7 |
| Set weight with stand (ca. kg) | 13,8 | 13,8 | 16,7 | 16,7 |
| Display | HD-LCD technology | HD-LCD technology | HD-LCD technology | HD-LCD technology |
| Picture diagonal (cm)/picture format | 66/16:9 | 66/16:9 | 80/16:9 | 80/16:9 |
| Resolution | 1366x768 | 1366x768 | 1366x768 | 1366x768 |
| Contrast ratio | 1200:1 | 1200:1 | 1200:1 | 1200:1 |
| Angle of viewing horizontally/vertically | 176° | 176° | 178° | 178° |
| Power consumption (IEC 62087) | | | | |
| in operation (watt) | 65 | 70 | 80 | 85 |
| in standby (watt) | < 3 | < 3 | < 3 | < 3 |
| Ambient temperature (Celsius) | 5° – 35° | | | |
| Relative humidity (not condensing) | 20 – 80% | | | |
| Barometric pressure | 800 – 1114 hPa (0 – 2000 m over NN) | | | |

 The code number 3001 cancels out a secret code and with it the child lock. Please keep in a safe place.

Technical data

Electrical data

| | |
|--|---|
| Chassis name | L 2650 |
| Power supply | 220 V -240V/50- 60 Hz |
| Tuner | VHF/UHF/ cable |
| Hyperband 8 MHz | 41 MHz to 860 MHz |
| Station storage locations | 430 / for DVB 1680 |
| TV standards | B/G, I, L, D/K, M, N DVB-T, DVB-C*, DVB-S* |
| Colour standard | SECAM, PAL, NTSC, NTSC-V, PAL-V (60Hz) |
| Sound standard | Mono/Stereo/Dual-channel Nicam B/G, I, L, Virtual Dolby |
| Rated audio power | 2 x 20 watt |
| Analogue Teletext | TOP/FLOF Level 2.5 |
| Page Memory (Concept L 26 / L 32) | 1500 |
| Page Memory (Concept L 26 Basic / L 32 Basic) | 1000 |
| Digital Teletext (only for MHEG-5 device versions) | MHEG-5 |

Connections

| | |
|--|--|
| Jack 3.5mm | Headphones 32- 2000 ohm |
| Mini-DIN (AVS) Video IN | Y/C (S-VHS/Hi 8) CVBS (VHS/8 mm) CVBS (VHS/8 mm) |
| Cinch (yellow) Video IN | L/R |
| Cinch (white/red) Audio IN | Antenna/cable/analogue PIP ⁽¹⁾ /DVB-T/C |
| IEC socket 75 Ohm/5 V/80 mA | ANT-SAT |
| F socket 75 Ohm 13/18 V/350 mA ⁽¹⁾ | Y/C (S-VHS/Hi 8) CVBS (VHS/8 mm) CVBS (VHS/8 mm) Y/C (S-VHS/Hi 8) |
| EURO-AV 1 Video IN | L/R |
| | L/R |
| | L/R |
| EURO-AV 2 Video IN | Y/C (S-VHS/Hi 8) CVBS (VHS/8 mm) RGB, YUV CVBS |
| | Y/C, (only with SVHS Link Plus) |
| | L/R |
| | L/R |
| Cinch Audio IN max. 2Vrms | Centre |
| 2 x Cinch Audio IN | L/R |
| 2 x Cinch Audio OUT (level adjustable in active loud speakers) | L/R |
| Cinch COMPONENT IN: | Cb/Pb signal |
| Cinch COMPONENT IN: | Cr/Pr signal |
| Cinch COMPONENT IN: | Y signal |
| Cinch Digital Audio IN (SPDIF) | Digital audio |
| Cinch Digital Audio OUT (SPDIF) | Digital audio |
| HDMI/DVI Digital Video/Audio IN type A 19pin | Digital video and audio |
| VGA/XGA VGA/XGA IN | PC/STB video signal |
| Mini-DIN SERVICE | Service/L-Link |

⁽¹⁾ Set-specific equipment and retrofitting options for CI-Slot, PIP and satellite tuners, see pages 41 and 42.



Dolby and the double 'D' symbol are trademarks of Dolby Laboratories

Printed in Germany
TB/06/08/7.0
Subject to modifications!
© by Loewe Opta 2006

Accessories

Wall holders and stands

Refer to the notes on the installations options on page 6.

PIP tuner

The PIP tuner enables picture in picture displays (PIP) for analogue terrestrial and cable reception.

You can retrofit either this PIP tuner or a digital satellite tuner.

The PIP function is possible for both retrofit versions.

You can find the retrofitting options for your set in the table on the next page.

Loewe order no. 89442.080

Digital Satellite tuner

You can have your TV set retrofitted with the digital satellite tuner. By using this tuner, you can receive DVB-S stations.

The digital satellite tuner is completely integrated in the TV set (physically and logically) and is operated by the remote control/menu control of the TV.

When you retrofit your TV set with the digital satellite tuner, your TV set automatically has the PIP function.

You can retrofit either this digital satellite tuner or a PIP tuner.

You can find the retrofitting options for your set in the table on the next page.

Loewe order no. 89361.056

Common Interface (CI-Slot)

The common interface (slot for CA-module) enables you to also receive encrypted stations.

You can purchase the CA-module and Smart Card at your specialist dealer.

You can find the retrofitting options for your set in the table on the next page.

Loewe order no. 89346.080

Loewe DVD players and recorders

The DVD players and recorders from Loewe are characterised by form and colour, which match Loewe TV sets, adapted user guidance and technology. A combination of the two devices forms a system which offers many advantages.

Loewe audio system Auro and the active speaker system Individual Sound

The interplay of a Loewe TV with a Loewe audio system and a Loewe speaker system creates an excellently coordinated home cinema system. Advantages are high operating comfort, attractive design and adapted technology.

Subject to delivery options.

Accessories

Retrofitting options

The following table shows the equipment and retrofitting options for the individual device versions.

| Device version / Equipment | Item no. | PIP tuner ¹ | Digital Single SAT-Tuner ² | Common Interface (CI-slot) |
|----------------------------|-------------------|------------------------|---------------------------------------|----------------------------|
| Concept L 26 Basic | 65433xxx | – | – | – |
| Concept L 26 DVB-T CI | 65421xxx (MHEG-5) | – | – | ● |
| Concept L 26 DVB-T/C CI | 65421xxx | – | ○ | ● |
| Concept L 32 Basic | 65434xxx | – | – | – |
| Concept L 32 DVB-T CI | 65442xxx (MHEG-5) | – | – | ● |
| Concept L 32 DVB-T/C | 66442xxx | ○ | ○ | ○ |

- available / installed
- retrofittable / optionally available
- retrofitting not possible

¹ You can retrofit either this PIP tuner or a digital satellite tuner.

² You can retrofit either this digital satellite tuner or a PIP tuner.

Service

(A)

Loewe Austria GmbH
Parking 10
1010 Wien, Österreich
Tel.: +43 - 810/0810-24 (zum Ortstarif)
E-Mail loewe@loewe.co.at

(AUS)

International Dynamics
Australasia Pty Ltd.
129 Palmer Street
Richmond 3121, Victoria, Australia
Tel. +61 - 3 - 94 29 08 22
Fax +61 - 3 - 94 29 08 33
Email mail@internationaldynamics.com.au

(B NL L)

Loewe Opta Benelux NV/SA
Uilenbaan 84
2160 Antwerpen, België
Tel. +32 - 3 - 2 70 99 30
Fax +32 - 3 - 2 71 01 08
Email ccc@loewe.be

(CH)

Telion AG
Rütistrasse 26
8952 Schlieren, Schweiz
Tel. +41 - 44 732 15 11
Fax +41 - 44 732 15 02
Email infocpe@telion.ch

(CY)

HADJIKYRIAKOS & SONS LTD.
Prodromou 121, P.O Box 21587
1511 Nicosia, Cyprus
Tel. +357 - 22 87 21 11
Fax +357 - 22 66 33 91
Email Efhymios@hadjikyriakos.com.cy

(CZ)

Ing. Ivo Tietz
Dolní nám. 9
746 01 Opava, Česko
Tel.: +420 553 624 944
Fax: +420 553 623 147
E-mail tietz@opava.cz

(D)

Loewe Opta GmbH,
Customer Care Center
Industriestraße 11
96317 Kronach, Deutschland
Tel. +49 1801-22256393
Fax +49 9261-99500
Email ccc@loewe.de

(DK)

Kjaerulff 1 A/S
C.F. Tietgens Boulevard 19
5220 Odense SØ, Denmark
Tel. +45 - 66 13 54 80
Fax +45 - 66 13 54 10
Email mail@kjaerulff1.com

(E)

Gaplasa S.A.
Conde de Torroja, 25
28022 Madrid, España
Tel. +34 - 917 48 29 60
Fax +34 - 913 29 16 75
Email loewe@maygap.com

(F)

Loewe Opta France S.A.
13 rue du Dépôt,
Parc del l'Europe, BP 10010
67014 Strasbourg Cédex, France
Tel. +33 - 3 - 88 79 72 50
Fax +33 - 3 - 88 79 72 59
Email loewe.france@wanadoo.fr

(FIN)

Kjaerulff 1 OY
Artturinkatu 2
20200 Turku, Finland
Tel. +358 - 2 284 1600
Fax +358 - 2 284 1601
Email Finland@kjaerulff1.com

(GB)

LinnSight Ltd.
PO Box 8465
KA 7 2YF Prestwick, UK
Tel. +44 - 12 92 - 47 15 57
Fax +44 - 12 92 - 47 15 54
Email helpline@linnsight.co.uk

(GR)

SIBA Engineering S.A.
6, Kifisou Av.,
122 42 Aegaleo, Hellas
Tel. +30 - 210 - 5913793
Fax +30 - 210 - 5317755
Email service@siba.gr

(H)

Basys Magyarorszagi KFT
Epitok utja 2-4
2040 Budaörs, Magyar
Tel. +36 - 23 41 56 37 (121)
Fax +36 - 23 41 51 82
Email basys@mail.basys.hu

(I)

Loewe Italiana SRL
Largo del Perlar, 12
37135 Verona (VR), Italia
Tel. +39 - 045 82 51 619
Fax +39 - 045 82 51 622
Email Angelo.Lorenzi@loewe.it

(IL)

PL Trading (pz 2004) Ltd.
27, Aliat Hanoar St.
Givataim 53401, Israel
Tel. +972 - 3 - 57 27 155
Fax +972 - 3 - 57 27 150
Email info@loewe.co.il

(M)

Mirage Holdings Ltd
Flamingo Complex, Cannon Road
Qormi, Malta
Tel. +356 - 22 - 79 40 00
Fax +356 - 21 - 44 59 83
Email servicing@mirage.com.mt

(MA)

SOMARA S.A.
377, Rue Mustapha El Maani
20000 Casablanca, Morocco
Tel. +212 - 22 22 03 08
Fax +212 - 22 26 00 06
Email somara@wanadoo.pro.ma

(N)

CableCom AS
Gneisveien 12
3221 Sandefjord, Norge
Tel. +47 - 33 48 33 48
Fax +47 - 33 44 60 44
Email soren@cablecom.no

(NZ)

International Dynamics (NZ) Pty Ltd
PO Box 109 317, Newmarket
Auckland, New Zealand
Tel.: +64 9 379 0179
Fax: +64 9 379 0279
E-mail: enquiries@internationaldynamics.co.nz

(P)

Videoacústica
Comercio e Representacoes de
Equipamentos Electronicos S.A.
Estrada Circunvalacao,
Quinta do Paizinho, Arm. 5
2795-632 Carnaxide, Portugal
Tel. +351 - 2 14 24 17 70
Fax +351 - 2 14 18 80 93
Email office@videoacustica.pt

(PL)

DSV TRADING SA
Plac Kaszubski 8
81-350 Gdynia, Polska
Tel. +48 - 58 - 6 61 28 00
Fax +48 - 58 - 6 61 44 70
Email market@dsv.com.pl

(RUS)

Service Center Loewe
ul. Verkhnyaya Maslovka, d. 29
125083 Moscow, Россия
Tel. +7 - 495 612 50 43
Fax +7 - 495 612 47 10
Email service@atc.ru

(S)

Kjaerulff 1 AB
Ridbanegatan 4, Box 9076
21377 Malmö, Sverige
Tel. +46 - 4 06 79 74 00
Fax +46 - 4 06 79 74 01
Email Sweden@kjaerulff1.com

(SK)

BaSys Czech & Slovak s.r.o.
Stará Vajnorská 17/A
831 04 Bratislava, Slovakia
Tel.: +421 2 49 10 66 18
Fax: +421 2 49 10 66 33
Email: loewe@basys.sk

(SLO)

Jadran Trgovsko Podjetje
Partizanska cesta 69
6210 Sezana, Slovenija
Tel. +386 - 57 31 04 40
Fax +386 - 57 31 04 42
Email milos.zvanut@jadran.si

(TR)

Enkay Elektronik Servis Müdürlüğü
Alemdag Cad: Site Yolu No.: 10
Ümraniye/ İstanbul, Türkiye
Tel. +90 - 216 634 44 44
Fax +90 - 216 634 39 88
Email mhatipog@enkaygroup.com

(ZA)

Videonix (Pty) Ltd
P.O. Box 31952, Kyalami 1684
Republic of South Africa
Tel. +27 - 1 14 66 47 00
Fax +27 - 1 14 66 42 85
Email mail@loewe.co.za

Free Manuals Download Website

<http://myh66.com>

<http://usermanuals.us>

<http://www.somanuals.com>

<http://www.4manuals.cc>

<http://www.manual-lib.com>

<http://www.404manual.com>

<http://www.luxmanual.com>

<http://aubethermostatmanual.com>

Golf course search by state

<http://golfingnear.com>

Email search by domain

<http://emailbydomain.com>

Auto manuals search

<http://auto.somanuals.com>

TV manuals search

<http://tv.somanuals.com>