



X50_{DS}

Fish-Finding Sonar Installation and Operation Instructions

**Copyright © 2006 Lowrance Electronics, Inc.
All rights reserved.**

No part of this manual may be copied, reproduced, republished, transmitted or distributed for any purpose, without prior written consent of Lowrance Electronics. **Any unauthorized commercial distribution of this manual is strictly prohibited.**

Lowrance® is a registered trademark of Lowrance Electronics, Inc.

Lowrance Electronics may find it necessary to change or end our policies, regulations, and special offers at any time. We reserve the right to do so without notice. All features and specifications subject to change without notice. All screens in this manual are simulated. On the cover: X50 DS shown.

**For free owner's manuals and other information,
visit our web site:
www.lowrance.com**

Lowrance Electronics Inc.
12000 E. Skelly Dr.
Tulsa, OK USA 74128-2486
Printed in USA.

Table of Contents

Introduction	1
Capabilities and Specifications: X50 DS	1
How Sonar Works.....	2
Preparations	3
Installation	4
Recommended Tools and supplies.....	4
Selecting a Transducer Location	5
How low should you go?	6
Shoot-Thru-Hull vs. Transom Mounting	7
Transom Transducer Assembly and Mounting	7
Trolling Motor Bracket Installation.....	12
Transducer Orientation and Fish Arches.....	13
Shoot-Thru-Hull Preparation	13
Testing Determines Best Location	15
Shoot-Thru-Hull Installation	16
Power Connections (permanent mount only)	17
Mounting the Sonar Unit: In-Dash, Bracket or Portable	18
Bracket Installation	19
Portable Sonar Installation	21
Installing the Batteries.....	22
Mounting the Unit	22
Portable Transducer Assembly	23
Portable Transducer Storage.....	25
Operation	27
Keyboard Basics	27
Memory	28
Menus.....	28
Display	29
Full Chart	29
Depth Range	30
Zoom	31
Sensitivity.....	32
Grayline®	34
Chart Speed	35
Frequency	36
Fish I.D.™	36
FishTrack™	38
Alarms.....	38
Fish Alarm	38
Depth Alarms	39
Shallow Alarm.....	39

Deep Alarm	40
Battery Alarm.....	40
Noise Rejection and ASP™	41
Depth Display.....	43
Temperature Display	43
Voltage	44
Backlight.....	44
Contrast	44
Simulator	44
Set Language.....	45
Software Information.....	45
Reset Options.....	45
Troubleshooting.....	46

Introduction

Thank you for buying an Lowrance® sonar! Your unit is a high-quality sonar designed for both professional and novice fishermen. All Lowrance sonars have an automatic mode that finds and displays the bottom, fish, underwater structure and more – right out of the box. All you have to do is press the on (**PWR**) key.

To get started with your Lowrance sonar, first read the installation section. It contains instructions for mounting the sonar unit, the transducer and any optional accessories, such as a speed sensor.

Following recommended installation practices will pay off in optimum performance of your Lowrance sonar. Improper installation can cause problems down the road, especially if the transducer is badly mounted.

After you've read the installation instructions, install the unit and accessories. Then, read the rest of the manual. The more you know about your sonar, the better it will work for you.

Capabilities and Specifications: X50 DS

General

- Case size:** 5.8" H x 4.3" W x 2.5" D (14.7 cm H x 10.8 cm W x 6.6 cm D) sealed, waterproof; suitable for saltwater use.
- Display:** High-contrast Film SuperTwist LCD. Diagonal viewing area: 4" (10.16 cm).
- Resolution:** 240 pixels (vert.) x 160 pixels (horiz.) resolution; 38,400 total pixels
- Backlighting:** incandescent backlit screen
- Input power:** 10 to 17 volts DC.
- Current drain:** 170 ma lights off; 240 ma lights on.
- Back-up memory:** Built-in memory stores sonar settings when unit is turned off.

Sonar

- Frequency:** 83/200 kHz.
- Transducers:** A dual search Skimmer® transducer with built-in temperature sensor is packed with your unit. It has a wide fish detection area of up to 60°/120° with high sensitivity settings. Operates at boat speeds up to 70 mph (61 kts).

Transmitter:..... 1,500 watts peak-to-peak power (typical);
188 watts RMS power (typical).

Sonar sounding

depth capability:..... 1,000 feet (305 meters). Actual capability depends on transducer configuration and installation, bottom composition and water conditions. All sonar units typically read deeper in fresh water than in salt water.

Depth display: Continuous digital readout.

Audible alarms:..... Deep/shallow/fish.

Automatic ranging: Yes, with instant screen updates.

Auto bottom track: Yes.

Zoom bottom track:..... Yes.

Split-screen zoom: No.

Surface water temp: Yes, built into transducer. Optional external temperature sensor or combo speed/temp sensor available.

NOTICE!

The storage temperature for your unit is from -4 degrees to +167 degrees Fahrenheit (-20 degrees to +75 degrees Celsius). Extended storage in temperatures higher or lower than specified will damage the liquid crystal display in your unit. This type of damage is not covered by the warranty. For more information, contact the factory's Customer Service Department; phone numbers are inside the manual's back cover.

How Sonar Works

Sonar has been around since the 1940s, so if you already know how it works, skip ahead to the next segment on the typographical conventions used in this manual. But, if you've never owned a sonar fish finder, this segment will tell you the underwater basics.

Sonar is an abbreviation for Sound Navigation and Ranging, a technology developed during World War II for tracking enemy submarines. A sonar consists of a transmitter, transducer, receiver and display. In simple terms, here's how it finds the bottom, or the fish:

The transmitter emits an electrical impulse, which the transducer converts into a sound wave and sends into the water. (The sound frequency can't be heard by humans or fish.) The sound wave strikes an object (fish, structure, bottom) and bounces back to the transducer, which converts the sound back into an electrical signal.

The receiver amplifies this return signal, or echo, and sends it to the display, where an image of the object appears on the scrolling sonar chart. The sonar's microprocessor calculates the time lapse between the transmitted signal and echo return to determine the distance to the object. The whole process repeats itself several times each second.

Dual Search Transducer

Your unit is packed with a Dual Search Skimmer Transducer that can transmit at 83 kHz and 200 kHz.

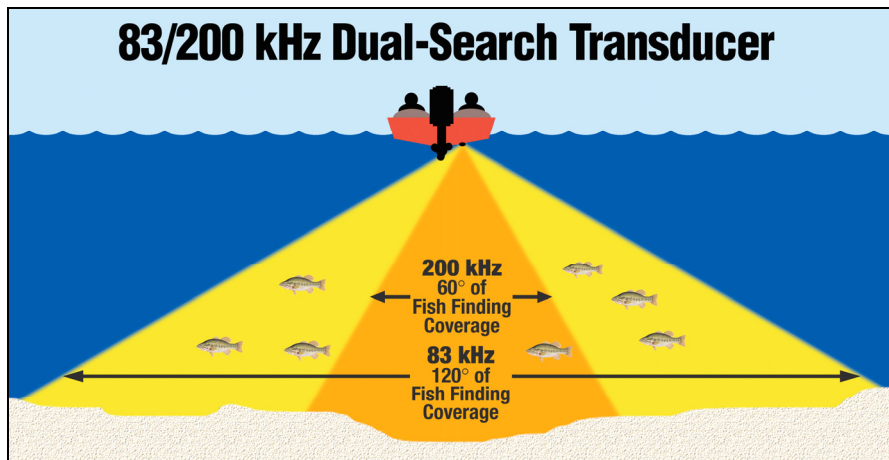

A new innovation, the 83 kHz frequency offers superior sonar performance at all depths from very shallow up to 1,000 ft and provides up to 120° of fishfinding coverage.

Preparations

The following shows the recommended sequence for installing the transducer:

CAUTION:

You should read over this entire installation section before drilling any holes in your vehicle or vessel!

1. Determine the approximate location for the sonar unit, so you can plan how and where to route the cables for the transducer and power. This will help you make sure you have enough cable length for the desired configuration.
2. Determine the approximate location for the transducer and its cable route.

3. Determine the location of your battery or other power connection, along with the power cable route.
4. Install the transducer and route the transducer cable to the sonar unit.
5. Route the power cable from the unit's location to an appropriate power source and connect it there.
6. Connect the transducer/power cable to the unit and mount the sonar unit on the bracket.

Installation

These instructions will help you install your Skimmer[®] transducer on a transom, on a trolling motor or inside a hull. Please read all instructions before proceeding with any installation. Your Skimmer transducer typically comes packaged with a one-piece stainless steel bracket for mounting it to the transom of your boat. The trolling motor mount uses a one-piece plastic bracket with an adjustable strap.

These are all "kick-up" mounting brackets. They help prevent damage if the transducer strikes an object while the boat is moving. If the transducer does "kick-up," the bracket can easily be pushed back into place without tools.

Depending on your sonar unit's connectors, your transducer cable may also have the sonar unit's power cable attached to it. If that is the case, be sure to install the transducer first, before connecting the power cable to a power source. See the instructions later in this manual for connecting the power cable to a battery or other power supply.

Read these instructions carefully *before* attempting the installation. Determine which of the mounting positions is right for your boat. Use extreme care if mounting the transducer inside the hull, because once it is epoxied into position, the transducer usually cannot be removed.

Remember, the transducer installation is the most critical part of a sonar installation.

Recommended Tools and supplies

If you prefer the option of routing the cable through the transom, you will need a 5/8" drill bit. Each transom mount requires use of a *high quality, marine grade* above- or below-waterline caulking compound.

NOTE:

The following installation types also call for these recommended tools and required supplies (supplies are *not* included):

Single-frequency transom installations

Tools include: two adjustable wrenches, drill, #29 (0.136") drill bit, flat-head screwdriver (for mounting screws and their pilot holes). Supplies: none.

Single-frequency trolling motor installations

Tools: two adjustable wrenches, flat-head screwdriver. Supplies: plastic cable ties.

Shoot-through hull installations

Tools: these will vary depending on your hull's composition. Consult your boat dealer or manufacturer. Supplies: 100 grit sandpaper, specially formulated epoxy adhesive available from LEI (see ordering information on the inside back cover). A sandwich hull also requires polyester resin.

Selecting a Transducer Location

1. The location must be in the water at all times, at all operating speeds.
2. The transducer must be placed in a location that has a *smooth flow* of water at all times. If the transducer is not placed in a smooth flow of water, interference caused by bubbles and turbulence will show on the sonar's display in the form of random lines or dots whenever the boat is moving.

NOTE:

Some aluminum boats with strakes or ribs on the outside of the hull create large amounts of turbulence at high speed. These boats typically have large outboard motors capable of propelling the boat at speeds faster than 35 mph. Typically, a good transom location on aluminum boats is between the ribs closest to the engine.

3. The transducer should be installed with its face pointing straight down, if possible. *For shoot-thru applications:* Many popular fishing boat hulls have a flat keel pad that offers a good mounting surface. On vee hulls, try to place the transducer where the deadrise is 10° or less.

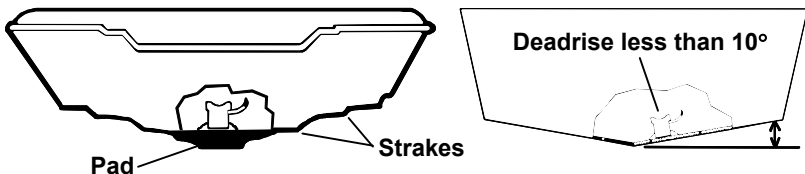

Vee pad hull (left); Vee hull (right). A pod style transducer is shown here, but the principle is the same for Skimmers inside a hull.

4. If the transducer is mounted on the transom, make sure it doesn't interfere with the trailer or hauling of the boat. Also, don't mount it closer than approximately one foot from the engine's lower unit. This will prevent cavitation (bubble) interference with propeller operation.

5. If possible, route the transducer cable away from other wiring on the boat. Electrical noise from engine wiring, bilge pumps and aerators can be displayed on the sonar's screen. Use caution when routing the transducer cable around these wires.

CAUTION: Clamp the transducer cable to transom near the transducer. This will help prevent the transducer from entering the boat if it is knocked off at high speed.

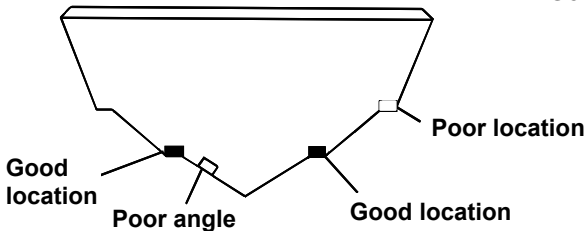
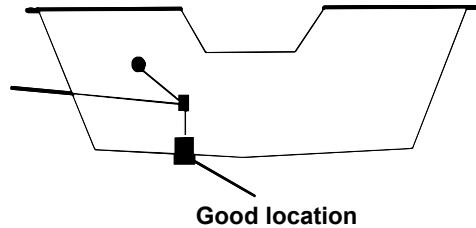

Good and poor transducer locations.

How low should you go?

For most situations, you should install your Skimmer transducer so that its centerline is level with the bottom of the boat hull. This will usually give you the best combination of smooth water flow and protection from bangs and bumps.

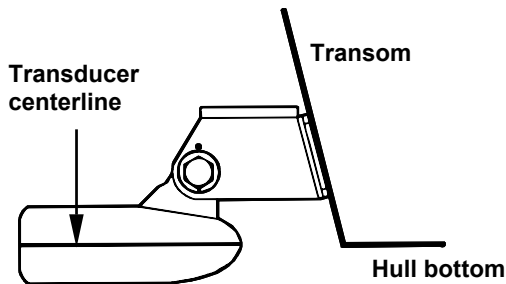

Align transducer centerline with hull bottom.

There, however, are times when you may need to adjust the transducer slightly higher or lower. (The slots in the mounting brackets allow you to loosen the screws and slide the transducer up or down.) If you frequently lose bottom signal lock while running at high speed, the transducer may be coming out of the water as you cross waves or wakes. Move the transducer a little lower to help prevent this.

If you cruise or fish around lots of structure and cover, your transducer may be frequently kicking up from object strikes. If you wish, you may move the transducer a little higher for more protection.

There are two extremes you should avoid. Never let the edge of the mounting bracket extend below the bottom of the hull. Never let the bottom – the face – of the transducer rise above the bottom of the hull.

Shoot-Thru-Hull vs. Transom Mounting

In a shoot-thru-hull installation, the transducer is bonded to the *inside* of the hull with epoxy. The sonar "ping" signal actually passes through the hull and into the water. This differs from a bolt-thru-hull installation (often called "thru-hull"). In that case, a hole is cut in the hull and a specially designed transducer is mounted *through* the hull with a threaded shaft and nut. This puts the transducer in direct contact with the water.

Typically, shoot-thru-hull installations give excellent high speed operation and good to excellent depth capability.

There is no possibility of damage from floating objects. It can't be knocked off when docking or loading on the trailer.

However, the shoot-thru-hull installation does have its drawbacks. First, some loss of sensitivity does occur, even on the best hulls. This varies from hull to hull, even from different installations on the same hull. This is caused by differences in hull lay-up and construction.

Second, the transducer angle cannot be adjusted for the best fish arches. This can be a problem on hulls that sit with the bow high when at rest or at slow trolling speeds.

Third, a transducer **CAN NOT** shoot through wood and metal hulls. Those hulls require either a transom mount or a thru-hull installation.

Fourth, a Skimmer transducer with a built-in temp sensor will show only the temperature of the bilge, not the water surface temp.

Follow the procedure listed in the shoot-thru-hull installation section at the end of this lesson to determine if you can satisfactorily shoot through the hull.

Transom Transducer Assembly and Mounting

The best way to install these transducers is to loosely assemble all of the parts first, place the transducer's bracket against the transom and see if you can move the transducer so that it's parallel with the ground.

1. Assembling the bracket. Press the two small plastic ratchets into the sides of the metal bracket as shown in the following illustration. Notice there are letters molded into each ratchet.

Place each ratchet into the bracket with the letter "A" aligned with the dot stamped into the metal bracket.

This position sets the transducer's coarse angle adjustment for a 14° transom. Most outboard and stern-drive transoms have a 14° angle.

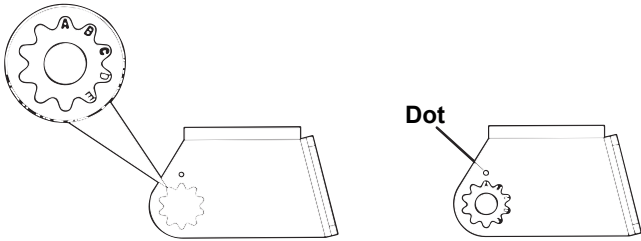

Align plastic ratchets in bracket.

2. Aligning the transducer on the transom. Slide the transducer between the two ratchets. Temporarily slide the bolt through the transducer assembly and hold it against the transom. Looking at the transducer from the side, check to see if it will adjust so that its face is parallel to the ground. If it does, then the "A" position is correct for your hull.

If the transducer's face isn't parallel with the ground, remove the transducer and ratchets from the bracket. Place the ratchets into the holes in the bracket with the letter "B" aligned with the dot stamped in the bracket.

Reassemble the transducer and bracket and place them against the transom. Again, check to see if you can move the transducer so it's parallel with the ground. If you can, then go to step 3. If it doesn't, repeat step 2, but use a different alignment letter until you can place the transducer on the transom correctly.

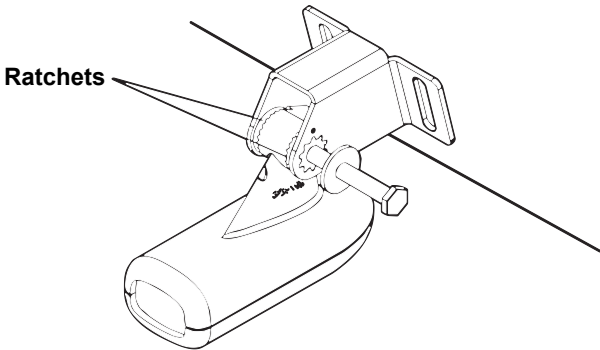

Insert bolt and check transducer position on transom.

3. Assembling the transducer. Once you determine the correct position for the ratchets, assemble the transducer as shown in the following figure. Don't tighten the lock nut at this time.

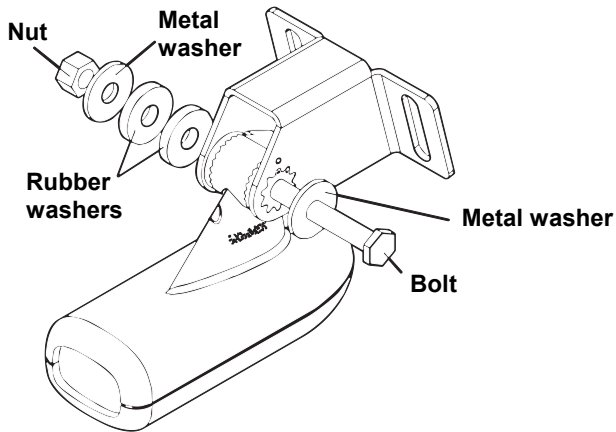

Assemble transducer and bracket.

4. Drilling mounting holes. Hold the transducer and bracket assembly against the transom. The transducer should be roughly parallel to the ground. The transducer's centerline should be in line with the bottom of the hull. Don't let the bracket extend below the hull!

Mark the center of each slot for the mounting screw pilot holes. You will drill one hole in the center of each slot.

Drill the holes. Use the #29 bit (for the #10 screws).

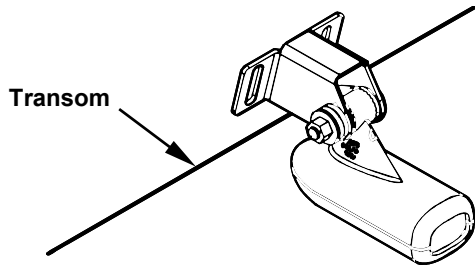
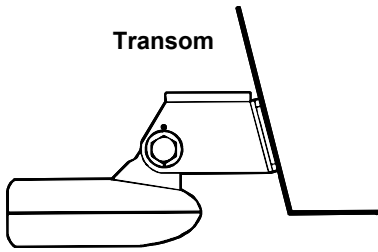

Position transducer mount on transom and mark mounting holes.
Side view shown at left and seen from above at right.

5. Attaching transducer to transom. Remove the transducer from the bracket and re-assemble it with the cable passing through the bracket over the bolt as shown in the following figures.

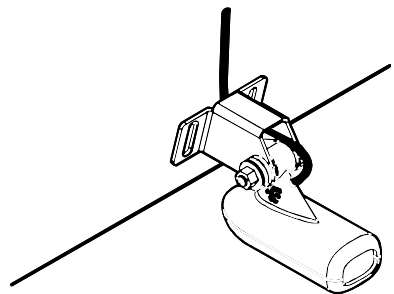
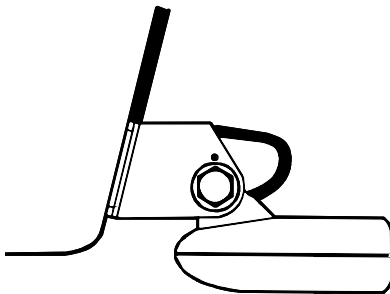

Route cable over bolt and through bracket.
Side view shown (left) and seen from above (right).

Attach the transducer to the transom. Slide the transducer up or down until it's aligned properly with the bottom of the hull as shown in the preceding and following figures. Tighten the bracket's mounting screws, sealing them with the caulking compound.

Adjust the transducer so that it's parallel to the ground and tighten the nut until it touches the outer washer, then add 1/4 turn. *Don't over tighten the lock nut!* If you do, the transducer won't "kick-up" if it strikes an object in the water.

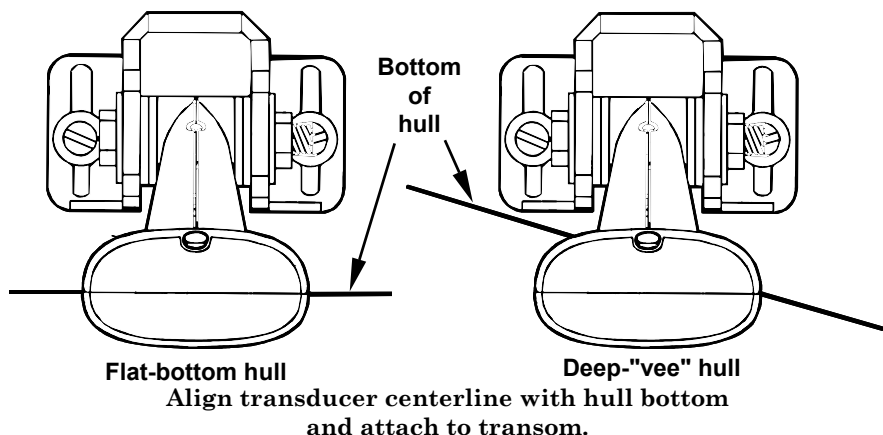

6. Route the transducer cable through or over the transom to the sonar unit. Make sure you leave some slack in the cable at the transducer. If possible, route the transducer cable away from other wiring. Electrical noise from the engine's wiring, bilge pumps, VHF radio wires, cables and aerators can be picked up by the sonar. Use caution when routing the transducer cable around these wires.

WARNING:

Clamp the transducer cable to the transom close to the transducer. This can prevent the transducer from entering the boat if it is knocked off at high speed.

If you need to drill a hole in the transom to pass the connector through, the required hole size is 5/8". (If you intend to route an additional speed or temp sensor cable through the same hole, you will need a 1" (25.4 mm) drill bit instead.)

Caution:

If you drill a hole in the transom for the cable, make sure it is located above the waterline. After installation, be sure to seal the hole with the same marine grade above- or below-waterline sealant used for the mounting screws.

7. Make a test run to determine the results. If the bottom is lost at high speed, or if noise appears on the display, try sliding the transducer bracket down. This puts the transducer deeper into the water, hopefully below the turbulence causing the noise. Don't allow the transducer bracket to go below the bottom of the hull!

Trolling Motor Bracket Installation

1. Attach the optional TMB-S bracket to the transducer as shown in the following figure, using the hardware supplied with the transducer. (Note: The internal tooth washer is supplied with the TMB-S.)

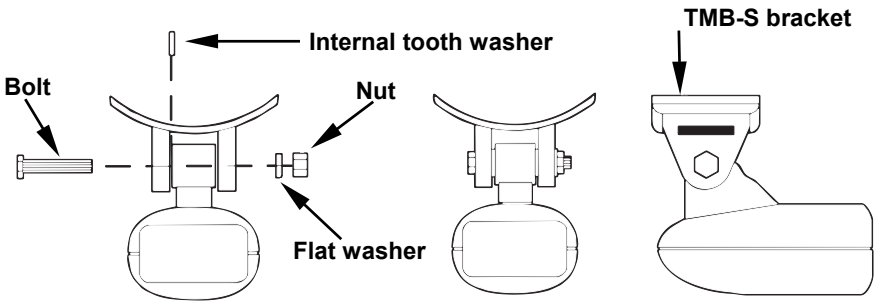

Attach motor mounting bracket to transducer.

2. Slide the adjustable strap supplied with the TMB-S through the slot in the transducer bracket and wrap it around the trolling motor.

Position the transducer to aim straight down when the motor is in the water. Tighten the strap securely.

3. Route the transducer cable alongside the trolling motor shaft. Use plastic ties (not included) to attach the transducer cable to the trolling motor shaft. Make sure there is enough slack in the cable for the motor to turn freely. Route the cable to the sonar unit and the transducer is ready for use.

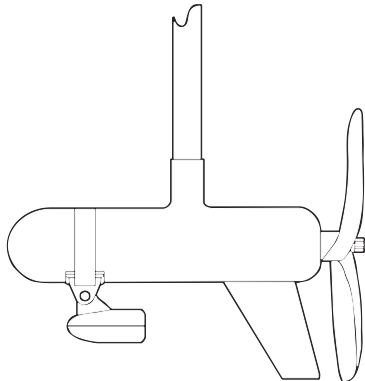

Transducer mounted on trolling motor, side view.

Transducer Orientation and Fish Arches

If you do not get good fish arches on your display, it could be because the transducer is not parallel with the ground when the boat is at rest in the water or at slow trolling speeds.

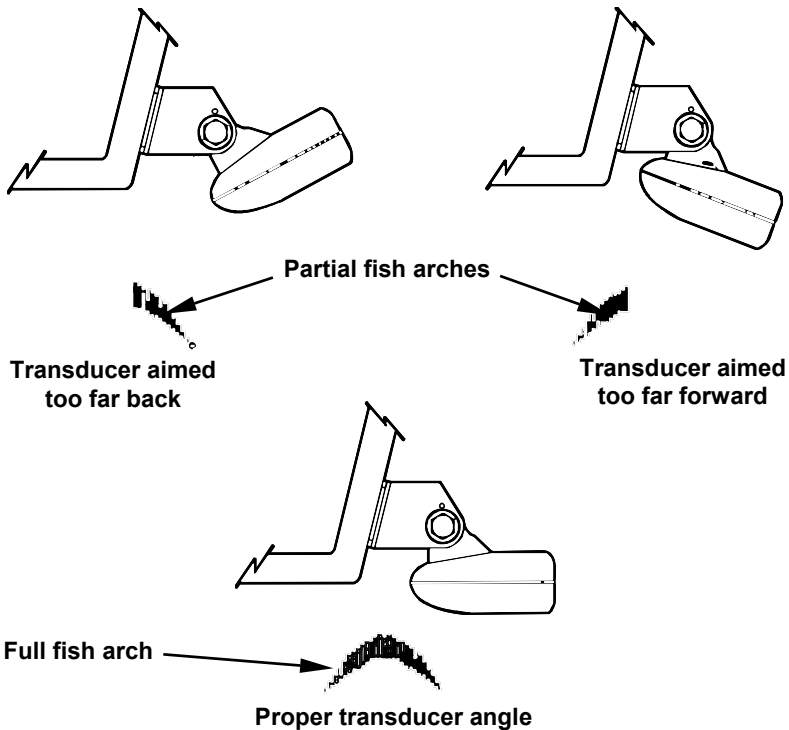

Transducer angles and their effects on fish arches.

If the arch slopes up – but not back down – then the front of the transducer is too high and needs to be lowered. If only the back half of the arch is printed, then the nose of the transducer is angled too far down and needs to be raised.

NOTE:

Periodically wash the transducer's face with soap and water to remove any oil film. Oil and dirt on the face will reduce the sensitivity or may even prevent operation.

Shoot-Thru-Hull Preparation

Hulls with Flotation Materials

The transducer installation inside a fiberglass hull must be in an area that does not have air bubbles in the resin or separated fiberglass lay-

ers. The sonar signal must pass through solid fiberglass. A successful transducer installation can be made on hulls with flotation materials (such as plywood, balsa wood or foam) between layers of fiberglass if the material is removed from the chosen area. See the figure below.

WARNING:

Do not remove any material from your inner hull unless you know the hull's composition. Careless grinding or cutting on your hull can result in damage that could sink your boat. Contact your boat dealer or manufacturer to confirm your hull specifications.

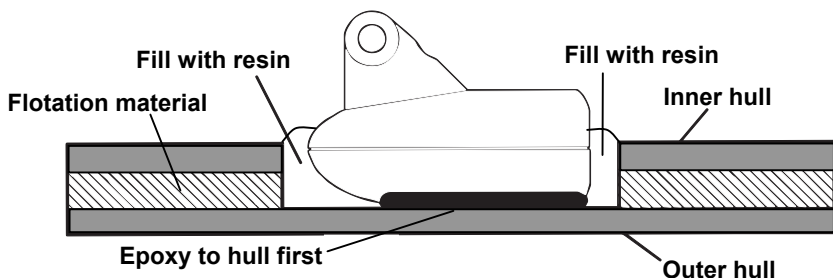

Epoxy the transducer to a solid portion of the hull.

For example, some (but not all) manufacturers use a layer of fiberglass, then a core of balsa wood, finishing with an outer layer of fiberglass. Removing the inner layer of fiberglass and the balsa wood core exposes the outer layer of fiberglass. The transducer can then be epoxied directly to the outer layer of fiberglass. After the epoxy cures for 24 hours, fill the remaining space with polyester resin. When the job is finished, the hull is watertight and structurally sound. Remember, the sonar signal must pass through *solid* fiberglass. Any air bubbles in the fiberglass or the epoxy will reduce or eliminate the sonar signals.

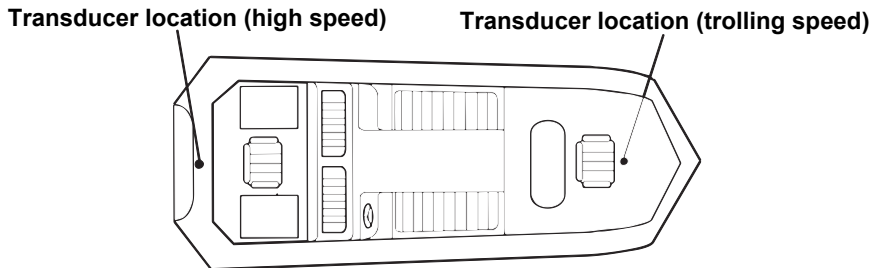

Shoot-thru-hull transducer locations for high speed or trolling speed operation.

Testing Determines Best Location

Ideally, the shoot-thru transducer should be installed as close to the transom as possible, close to the centerline. This will give you the best performance during high speed maneuvers.

1. Anchor the boat in about 30 feet of water. Add a little water to the sump of the boat. Plug the transducer into the sonar unit, turn it on, then hold the transducer over the side of the boat in the water. Adjust the sensitivity and range controls until a second bottom echo is seen on the display. (You'll need to turn off Auto Sensitivity, Auto Depth Range and ASP™. Try a range setting that is two to three times the water depth. The harder (more rocky) the bottom, the easier it will be to get a second bottom signal.) Don't touch the controls once they've been set.

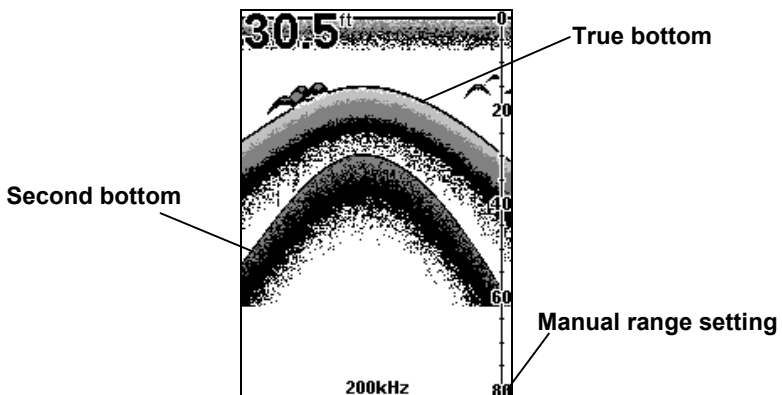

Example of a second bottom signal. Unit is in 30 feet of water, with range set at 80 feet and sensitivity set at 87 percent.

2. Next, take the transducer out of the water and place it in the water in the sump of the boat, face down. (The transducer face is shown in the figure on the following page.) Notice how the signal strength decreases. The second bottom signal will probably disappear and the bottom signal intensity will likely decrease.

3. Now move the transducer around to find the best location with the strongest possible bottom signal. If you find a spot with an acceptable bottom signal, mark the location and move on to step 4.

If you can't get an acceptable bottom signal, try turning up the sensitivity by three or five keystrokes and then move the transducer around once more. If you find a spot that works, mark it and move on to step 4.

If you have to turn up sensitivity by more than five keystrokes to get a good signal, the transducer should be mounted on the outside of the

hull. This is especially true if you have to turn sensitivity all the way up to get a decent bottom signal.

4. Most people can get good results by following steps 1 through 3, so this step is *optional*. If you want to make an extra effort to be absolutely sure that your selected location will work under all conditions, make a test run with the boat on plane and observe the bottom signal. You'll need to figure some way to prop the transducer into position while you make your test run. (A brick or two might be sufficient to hold it in place.)

5. When you're satisfied with a location, mark it and proceed with the installation.

Shoot-Thru-Hull Installation

1. Make sure the area is clean, dry and free of oil or grease, then sand both the inside surface of the hull and the face of the transducer with 100 grit sandpaper. The sanded hull area should be about 1-1/2 times the diameter of the transducer. The surface of the hull must be flat so the entire transducer face is in contact with the hull prior to bonding. After sanding, clean the hull and transducer with rubbing alcohol to remove any sanding debris.

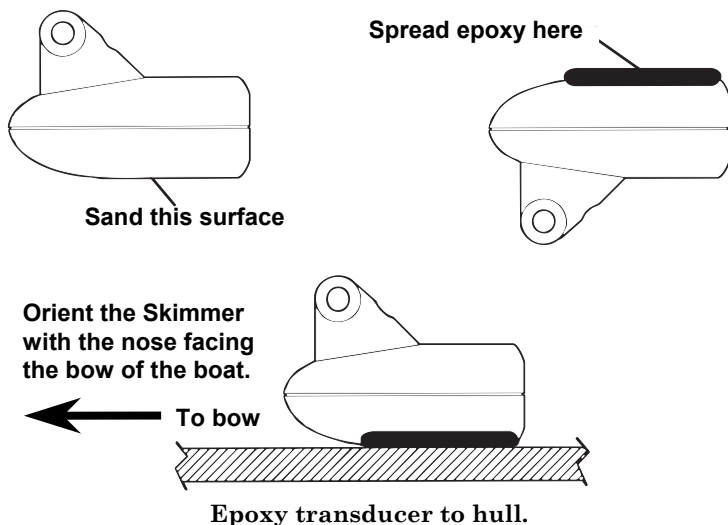

WARNING:

Use *only* the epoxy available from LEI. It has been formulated to work with these installation procedures. Other epoxy types may be too thin or may not cure to the right consistency for optimum transducer performance.

2. The epoxy consists of the epoxy itself and a hardener. Remove the two compounds from the package and place them on the paper plate.

Thoroughly stir the two compounds together until the mixture has a uniform color and consistency. Do not mix too fast or bubbles will form in the epoxy. After mixing, you have 20 minutes to complete the installation before the epoxy becomes unworkable.

Spread a thin layer of epoxy (about 1/16" or 1.5 mm thick) on the face of the transducer as shown in the previous figure.

Make sure there are no air pockets in the epoxy layer! Then, apply the remaining epoxy to the sanded area on the hull.

3. Press the transducer into the epoxy, twisting and turning it to force any air bubbles out from under the transducer face. Stop pressing when you bottom out on the hull. When you're finished, the face of the transducer should be parallel with the hull, with a minimum amount of epoxy between the hull and transducer.

4. Apply a weight, such as a brick, to hold the transducer in place while the epoxy cures. Be careful not to bump the transducer while the epoxy is wet. Leave the weight in place for a minimum of three hours. Allow the epoxy to cure for 24 hours before moving the boat.

5. After the epoxy has cured, route the cable to the sonar unit and it's ready to use.

Power Connections (permanent mount only)

The unit works from a 12-volt battery system. You can attach the power cable to your boat's accessory or power buss (or directly to the battery). If you use an accessory buss but have problems with electrical interference, attach the power cable directly to the battery. If the cable is not long enough, splice #18 gauge wire onto it.

CAUTION:

When using the unit in a saltwater environment, we strongly recommend that you shut off the power supply to the power cable when the unit is not in use. When the unit is turned off but still connected to a power supply, electrolysis can occur in the power cable plug. This may result in corrosion of the plug body along with the electrical contacts in the cable and the unit's power socket.

In saltwater environments we recommend you connect the power cable to the auxiliary power switch included in most boat designs. If that results in electrical interference, or if such a switch is not available, we recommend connecting direct to the battery and installing an inline switch. This will let you shut off power to the

power cable when the unit is not in use. When you are not using the unit, you should always shut off power to the power cable, especially when the power cable is disconnected from the unit.

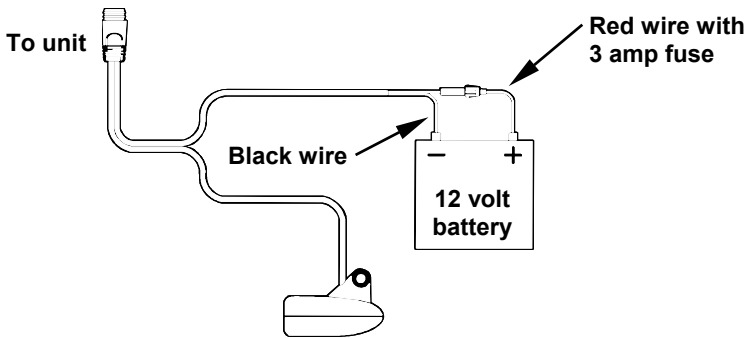

Power connections for the X50 DS sonar unit (direct battery connection shown).

If possible, keep the power cable away from other boat wiring, especially the engine's wires. This will provide the best isolation from electrical noise. The power cable has two wires, red and black. Red is the positive lead, black is negative or ground. Make sure to attach the in-line fuse holder to the red lead *as close to the power source as possible*.

For example, if you have to extend the power cable to the battery or power buss, attach one end of the fuse holder directly to the battery or power buss. This will protect both the unit and the power cable in the event of a short. It uses a 3-amp fuse.

Caution:

Do not use this product without a 3-amp fuse wired into the power cable! Failure to use a 3-amp fuse will void your warranty.

This unit has reverse polarity protection. No damage will occur if the power wires are reversed. However, the unit will not work until the wires are attached correctly.

Mounting the Sonar Unit: In-Dash, Bracket or Portable

You can install the sonar unit on the top of a dash with the supplied bracket. This unit can be installed in a dash with the optional FM-6 in-dash adapter kit. The FM-6 kit includes an instruction sheet, part 988-0147-631, which contains a template for cutting out the mounting hole. This document can be downloaded free from the www.lowrance.com web site.

Bracket Installation

Recommended tools for this job include: drill, 1" (25.4 mm) drill bit, screwdriver. Required supplies for this job include: *high quality, marine grade* above- or below-waterline caulking compound, three #10 stainless steel screws. Screw length and type should be suitable for the material on which you intend to mount the bracket.

Mount the unit in any convenient location, provided there is clearance when it's tilted for the best viewing angle. You should also make sure there is enough room behind the unit to attach the power/transducer cable. (See the following drawings, which show the dimensions of a gimbal-mounted X50 DS sonar unit.)

Holes in the bracket's base allow wood screw or through-bolt mounting. You may need to place a piece of plywood on the back side of thin panels to reinforce the panel and secure the mounting hardware.

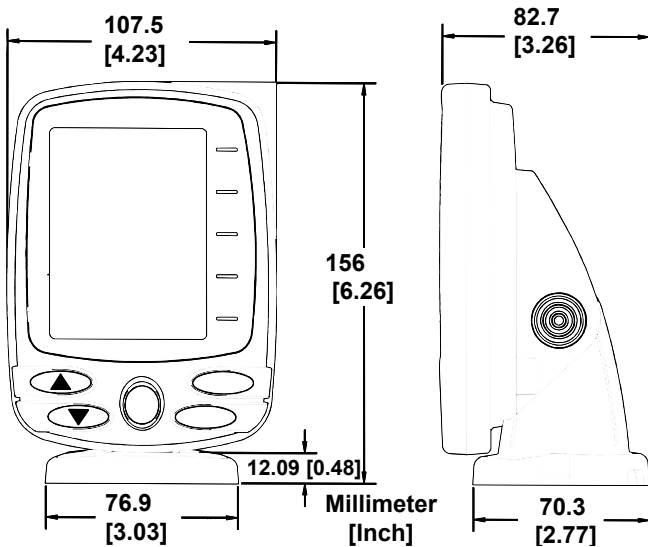

Front view (left) and side view (right) showing dimensions of the X50 DS when mounted on quick release bracket.

Drill a 1" (25.4 mm) hole in the dash for the power/transducer and accessory cables. The best location for this hole is immediately under the gimbal bracket location. This way, the bracket can be installed so that it covers the hole, holds the cables in position and results in a neat installation. Some customers, however, prefer to mount the bracket to the side of the cable hole — it's a matter of personal preference.

After drilling the hole, pass the connectors *up* through the hole from under the dash. If you wish, you can fill in the hole around the cable with a good marine caulking compound. (Some marine dealers stock cable hole covers to conceal the opening.)

Using the Quick Release Mounting Bracket

These units use a quick release mounting bracket. When you run the cables through the bracket's cable slots, make sure you allow enough slack for tilting the unit and attaching the connector. (The snug fit of the push-on waterproof connector requires some force to attach.)

Align the bracket over the cable hole with the cable slots facing away from you and fit the cable through one of the slots. Fasten the bracket to the dash using the three screw holes.

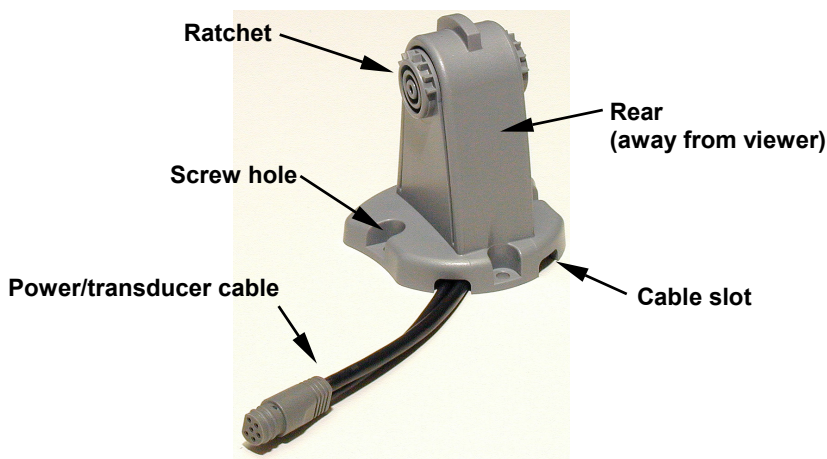

X50 DS quick release mounting bracket. Slots in the base allow routing the cable from beneath the mount.

Attach the unit to the bracket by first connecting the power/transducer and accessory cables. Then, hold the sonar unit vertically and slide it onto the bracket from above. (The back of the unit should be touching the front of the bracket as you lower it into position.) As you push down, the unit will lock into place with a distinct click.

To adjust the viewing angle, pinch the ratchets with one hand, then tilt the unit with your other hand. Release the ratchets and the unit locks into the new position. To dismount the unit for storage, press the ratchets and lift the unit off the bracket.



Mount the sonar: slide the unit onto the bracket from above.



Adjust viewing angle: use one hand to press and release the spring-loaded ratchets while you move the unit with the other hand.

Portable Sonar Installation

Like many Lowrance products, the X50 DS sonar is capable of portable operation. It uses the optional PPP-12 portable power pack. The power pack and portable transducers expand the uses for your sonar.

You can use your X50 DS sonar unit on your boat or take it to the dock, on a float tube, on an ice fishing trip or use it as a second sonar in a friend's boat.

The PPP-12 package includes the power pack, battery adapter and a portable transducer. The transducer can be stored inside the power pack. The PPP-12 requires eight AA alkaline batteries. Batteries are not included.

To use a portable power pack, you install the batteries and then attach the sonar unit to the power pack's bracket. Plug in the power/transducer cable and you're ready to fish. The PPP-12 has a quick-release mounting bracket built into the case.

Installing the Batteries

Open the case and lay it flat. (The latch is located below the handle.) Insert eight "AA" size batteries into the battery adapter and place it in the battery compartment. Slip the battery cover tabs into the slots in the case wall, then close the battery cover with the thumb screw.

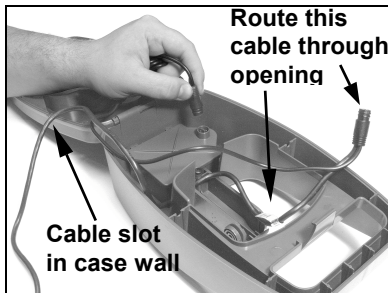
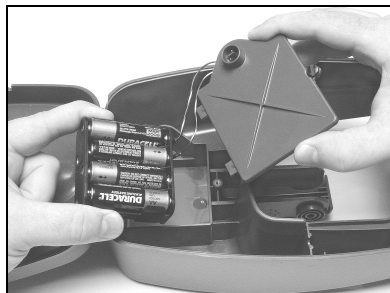

**Install batteries in battery compartment (left).
Attach power cable, and route wires as shown (right).**

Plug the cable's power (dog bone-shaped) connector into the socket on the battery compartment cover. Route the cable's unit connector and about 6 inches (15.2 cm) of cable through the opening under the sonar mount. Close the case bottom, using the slot in the case wall to avoid pinching the cable. Turn the unit over to mount the sonar.

CAUTION:

When using the sonar in a saltwater environment, we strongly recommend that you unplug the power connector from the battery socket when the unit is not in use. When the unit is turned off but still connected to a power supply, electrolysis can occur in the power cable plug. This may result in corrosion of the plug body along with the electrical contacts in the cable and the unit's power socket.

Mounting the Unit

A quick-release mount is built into the top of the portable power pack. To attach the unit, first plug in the cable connector. Then, hold the sonar unit vertically and slide it onto the bracket from above. (The back of the unit should be touching the front of the bracket as you lower it into position.) As you push down, the unit will lock into place with a distinct click.

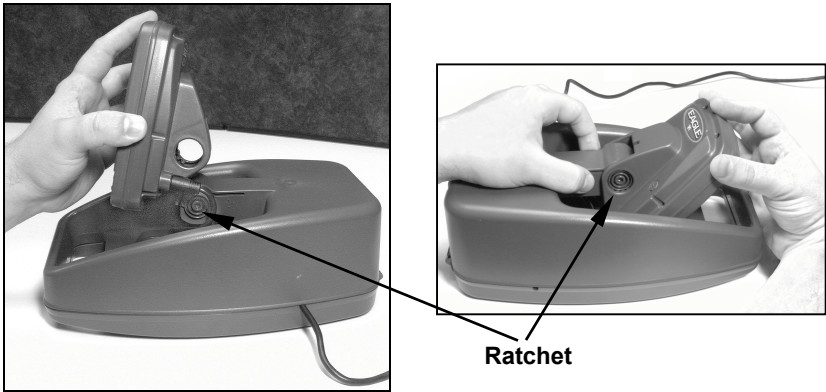

To mount the sonar, slide the unit onto the bracket from above (left). To adjust the view, press and release spring-loaded ratchets while tilting the unit (right).

To adjust the viewing angle, pinch the quick-release mount's ratchets with one hand, then tilt the unit with your other hand. Release the ratchets and the unit locks into the new position. To remove the unit from the PPP-12, press the ratchets and lift the unit off the bracket.

Turn the sonar unit on. If it works, turn it off and finish assembling the portable transducer. If it doesn't work, make sure the battery terminals are making good contact against the battery contacts. Also make sure the batteries are oriented correctly in the battery adapter.

If it still doesn't work, check the battery voltage. Most complaints we hear about portable units result from stale batteries. Make sure you buy fresh ones. Always remove batteries from the compartment when storing the unit because dead batteries can leak and corrode the contacts.

In cold weather the efficiency of dry cell batteries drops with the temperature. We find it a good idea to have the batteries and the sonar unit good and warm before we leave home.

If the batteries do lose a charge, you can sometimes restore them by placing them in a warm room or car interior. A better way is to replace them with batteries that have been kept warm.

WARNING:

Never heat batteries over an open flame or direct hot air onto them. A fire or explosion could result.

Portable Transducer Assembly

Assemble the transducer and portable bracket as shown in the following illustrations.

Make sure there is one washer on each side of the transducer, inside the bracket. Slide the other washer over the end of the bolt and screw on the nut.

Screw the suction cup onto the bracket using the supplied screw and flat washer. Tie the nylon cord through the hole in the top of the bracket. When using the transducer, tie the other end of the nylon cord to the boat. This will help prevent losing the transducer if it comes off.

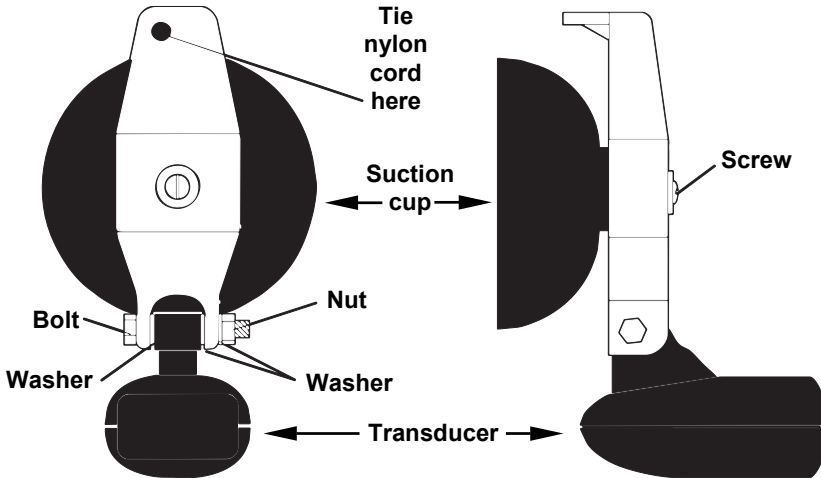

Portable transducer assembly: rear view (left) and side view (right).

Clean the chosen area of the hull before attaching the suction cup. Locate the transducer on the hull as shown in the following figure. Don't let the bracket extend below the hull, because water pressure against it can cause the suction cup to come off at speed.

NOTE:

For optimum operation, the portable transducer should be adjusted so that it is parallel to the ground. For more information on this, see the segment in the unit's operation manual on Transducer Orientation and Fish Arches.

Moisten the suction cup, then press it onto the hull as firmly as possible. Tie the nylon cord to the boat and set the power pack and sonar unit in a location for easy viewing. Your portable sonar is now ready for use.

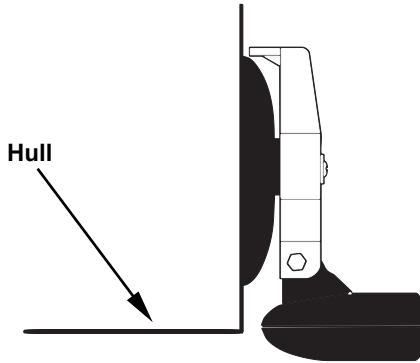

Portable transducer installed on boat transom.

Portable Transducer Storage

There is room inside the power pack for the portable transducer. When you're finished fishing, tilt the sonar down to the storage position. Open the case and lay it flat.

Unplug the power connector from the battery compartment socket. Wrap the transducer cable around the suction cup, then stow the transducer on top of the battery compartment cover. Close the case and your equipment is ready for transport.



Stow transducer on top of battery cover.

Notes

Operation

Keyboard Basics

The unit sounds a tone when you press any key. This tells you the unit has accepted a command. Numbers in the figure correspond to key explanations below:



Lowrance X50 DS.

1. PWR/CLEAR

In this manual, the Power/Clear key is referred to as **PWR**. Press this key to turn the unit on and off. It also clears menus and menu selections from the screen. To clear a menu from the screen, press **PWR**.

NOTE:

Hold the **PWR** key down for five seconds to turn off the unit.

2. MENU UP & MENU DOWN

These keys appear in the manual text as **MENU UP** or **MENU DOWN**. Most of the time, you can press either of the menu keys, so in those

cases, the text uses the word **MENU**. Usually, when the instructions say **MENU**, you can press the **MENU UP** key for consistency.

The **MENU UP** key cycles forward through the menus. The **MENU DOWN** key moves backward through the menus. To check out the menus, repeatedly press a **MENU** key to scroll through them.

3. UP & DOWN ARROWS (↑ ↓)

These Up and Down arrow keys are referred to as ↓ (**DOWN**) or ↑ (**UP**) in this manual. You will use these keys to adjust most features and functions on the X50 DS.

Memory

This unit has permanent memory that saves the following user settings when power is turned off: Units of Measure, Temp Size, Depth Size, Fish I.D. mode, Noise Reject mode, Range mode, Zoom, Sensitivity, Grayline, Chart Speed, Battery Alarm, Display Contrast, Backlight, Language, Fish Alarm, Battery Alarm and Shallow and Deep alarms. It does not require, nor does it use an internal backup battery, so you never have to worry about replacement batteries.

Menus

This unit's menus will guide you through its various functions and features. Menu names and settings appear in the manual as small capital letters like **SENSITIVITY**, which refers to the Sensitivity menu.

The **MENU** keys access these features, allowing you to customize unit settings. To switch menus, press **MENU** repeatedly. Press **PWR** to clear menus from the screen.

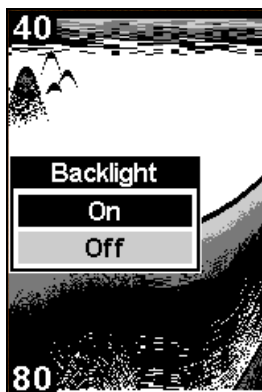

The Backlight menu with backlight turned on.

Display

The lights will flash for about 10 seconds when the unit is turned on. The backlight menu will appear on the screen. Use the **ARROW** keys to turn the backlight on or off. Press **PWR** to clear the menu from the screen.

The unit will show the Full Chart Page or mode. The Fish I.D.[™] fish symbol feature is on by default. The depth range is displayed as the upper and lower limit on the left side of the screen. In the following figure, the screen shows a depth range from 0 to 80 feet and the bottom depth is 36.9 feet, shown by the digital sonar. The water temperature is 34.5° F.

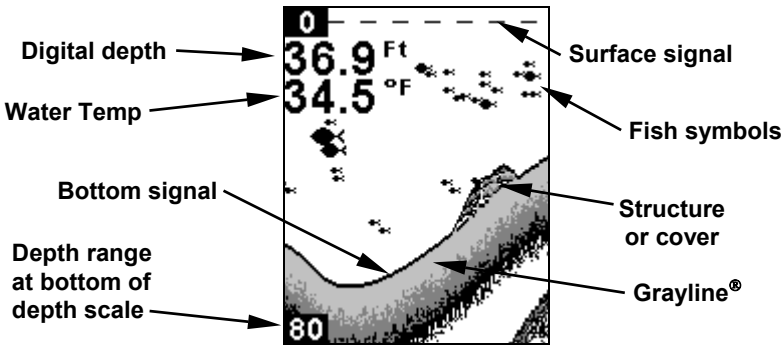

Opening screen, Full Chart page, or mode. The factory default setting has the Fish I.D. (fish symbols) turned on.

Full Chart

The unit's default page, Full Chart shows all echoes scrolling across the full screen. The bottom signal scrolls across the screen from right to left. The line at the top of the screen represents the surface. The bottom depth — determined by the digital sonar — shows in the upper left corner.

If the transducer with a built-in temperature sensor is connected, a digital display for water temperature also will be shown. This temperature display can be turned on and off.

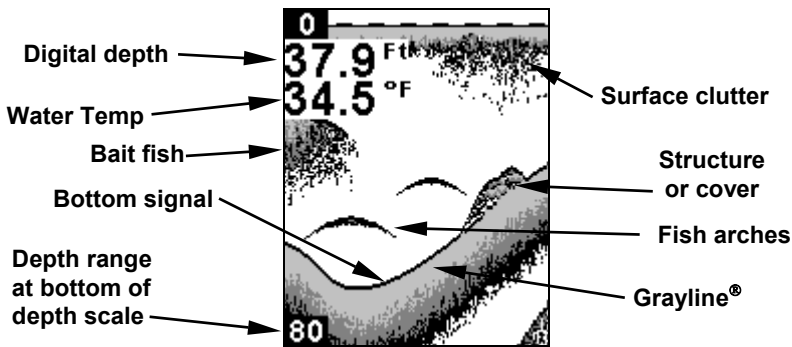

Full Chart page, showing digital depth (above) and temp (below). The Fish I.D. feature is turned off.

Depth Range

When turned on, the unit automatically adjusts the depth range according to water conditions. When in auto range mode, it always keeps the bottom displayed in the lower portion of the screen. You can override the automatic depth range control and manually select a depth range.

To do this, repeatedly press **MENU** until the **DEPTH RANGE** menu appears. Press **↓** to select **MANUAL**, then press **MENU UP** to display the **RANGE SIZE** menu. Use the arrow keys to select a desired depth range. When you are finished, press **PWR** to clear the menu from the display.

This unit has the following depth ranges: 10, 20, 40, 80, 150, 300, 600, 1000 and 2000 feet.

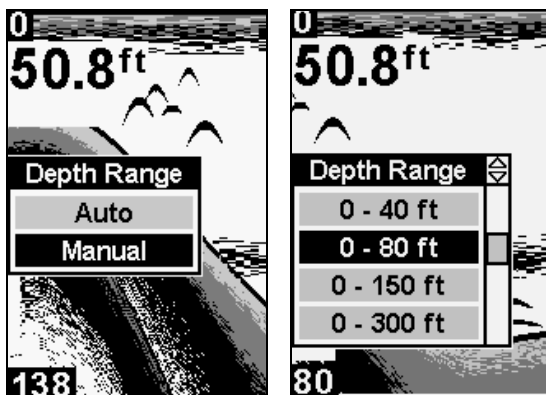

Depth Range menu with Manual setting selected (left). Range Size menu with 0-80 ft highlighted (right).

Zoom

The zoom feature enlarges all images on the screen by doubling the size of the echoes (a 2X zoom). For example, if the current auto depth range is 0 to 60 feet, Zoom will show an enlarged view of the water column from 30 feet to 60 feet, always keeping the bottom in view.

To zoom in the display, repeatedly press **MENU** until the **ZOOM** menu appears. Press ↓ to select **ON**, then press **PWR** to clear the menu.

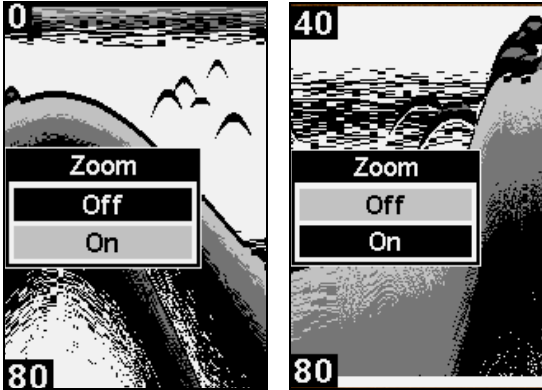

Zoom feature turned off (left). Zoom turned on (right).

You can tell when the display is in Zoom mode when the top of the depth scale on the left of the screen no longer shows zero. For example, if the current range is 0 to 80 feet with zoom off, switching to zoom would enlarge the water column from 40 feet to 80 feet. The number 40 would appear at the top of the depth range scale.

To turn off the zoom feature, repeatedly press **MENU** until the **ZOOM** menu appears. Press ↑ to select **OFF**, then press **PWR** to clear the menu. The top of the depth range scale returns to zero.

NOTE:

Using the Zoom command while in *auto* Zoom mode will always enlarge the echoes near the bottom, because auto Range always keeps the bottom displayed in the lower portion of the screen.

When you choose to use the zoom feature while the unit is in *manual* Depth Range mode, you can select one of 17 pre-set Zoom Ranges. This lets you enlarge a desired segment of the water column.

To do this, make sure Depth Range is set to manual mode. Next, repeatedly press **MENU** until the **ZOOM** menu appears. Press ↓ to select **ON**, then press **MENU UP** to display the **ZOOM RANGE** menu.

Use the arrow keys to select a desired zoom size. When you are finished, press **PWR** to clear the menu from the display.

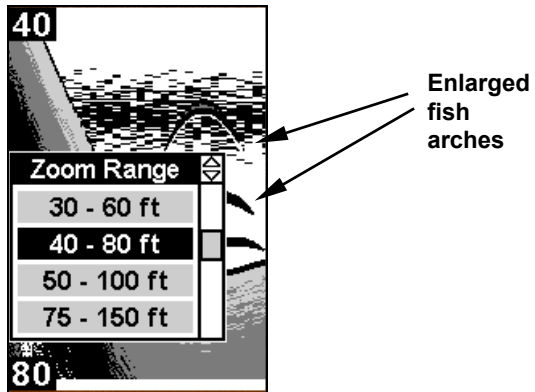

Zoom Range menu with the 40-80 foot zoom selected.

You can select from these zoom size ranges: 0-10, 5-15, 10-20, 15-30, 20-40, 30-60, 40-80, 50-100, 75-150, 100-200, 150-300, 200-400, 300-600, 400-800, 500-1000, 750-1500 and 1000-2000.

Sensitivity

Sensitivity adjusts the way echoes will be displayed on the screen. If you want to see more detail, try increasing the sensitivity, a little at a time. There are situations when too much clutter appears on the screen. Decreasing the sensitivity can reduce the clutter and show the strongest fish echoes, if fish are present. As you change the sensitivity setting, you can see the difference on the chart as it scrolls.

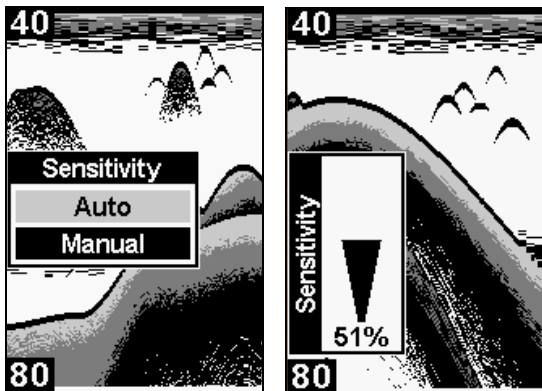

Sensitivity set to manual mode (left). Sensitivity scroll bar (right).

You can change the sensitivity level whether you are in Auto Sensitivity mode or Manual Sensitivity mode. The adjustment method works the same in both modes, but gives you slightly different results.

To adjust sensitivity in Auto Mode:

Repeatedly press **MENU** until the **SENSITIVITY** menu appears. Make sure sensitivity is set to Auto, then press **MENU UP** to access the sensitivity scroll bar. Press **↑** to increase the sensitivity, **↓** to decrease it. When it is set at the desired level, press **PWR** to clear the menu. If you reach the maximum or minimum sensitivity level, a tone sounds alerting you to the limits.

To adjust sensitivity in Manual Mode:

If you want to change the sensitivity in Manual Mode, turn off Auto Sensitivity. Repeatedly press **MENU** until the **SENSITIVITY** menu appears. Press **↓** to select **MANUAL**, then press **MENU UP** to access the sensitivity scroll bar. Press **↑** to increase sensitivity, **↓** to decrease it. When it is set at the desired level, press **PWR** to clear the menu.

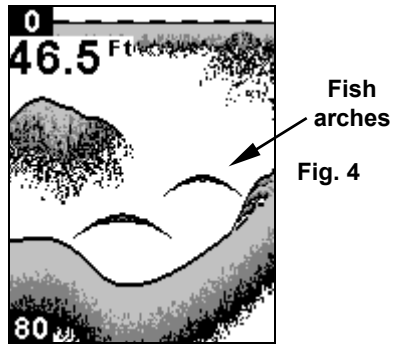
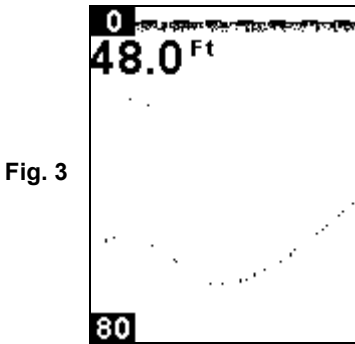
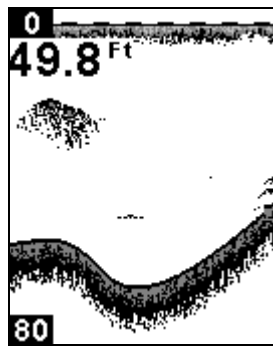
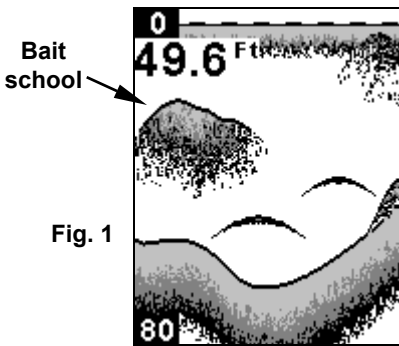

These figures show results of different sensitivity levels on the same location. Fig. 1: Sensitivity at 98 percent, determined by Auto Sensitivity. Typical of full auto mode. Fig. 2: Sensitivity set at 71 percent. Fig. 3: Sensitivity set at 47 percent. Fig. 4: Sensitivity set at 100 percent.

Grayline®

Grayline® lets you distinguish between strong and weak echoes. It allows you to tell the difference between a hard and soft bottom. For example, a soft, muddy or weedy bottom returns a weaker signal which is shown with a narrow line or no gray line at all. A hard bottom returns a strong signal, which will be displayed as a wide gray line.

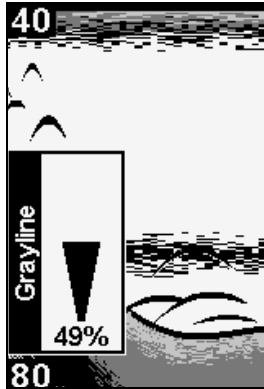

Grayline scroll bar.

If you have two signals of equal size, one with gray and the other without, then the target with gray is the stronger signal. This helps distinguish weeds from trees on the bottom or fish from structure.

Grayline is adjustable. Since Grayline shows the difference between strong and weak signals, adjusting the sensitivity may also require a different Grayline level. The level chosen by the sonar unit at power on is usually adequate for most conditions. Experiment with your unit to find the Grayline setting that's best for you.

To change the Grayline level, repeatedly press **MENU** until the **GRAYLINE** scroll bar appears.

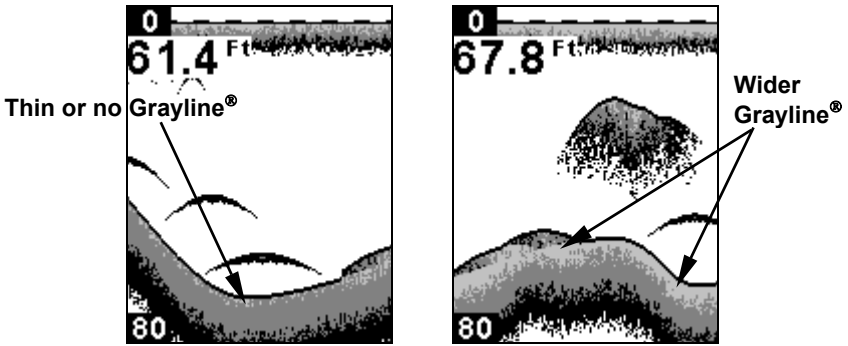

A small amount of Grayline indicates a soft bottom (left), probably sand or mud. More Grayline indicates a harder, rocky bottom (right). Press \uparrow to increase Grayline, \downarrow to decrease it. Echoes scrolling on the screen will show the effects of the Grayline adjustment. If you reach the maximum or minimum level, a tone sounds alerting you to the limits. Press **PWR** to clear the menu.

Chart Speed

The speed at which echoes scroll across the screen is called the chart speed. The default for this unit is "max" (100 percent). We recommend you leave the scroll speed setting there for most all fishing conditions.



Chart Speed scroll bar.

You, however, might consider experimenting with chart speed when you are stationary or drifting very slowly. Sometimes, you may achieve better images as you decrease the chart speed to match the speed of your boat.

If you are at anchor, ice fishing or fishing from a dock, experiment with a chart speed of 25 percent. If you are drifting slowly, try a chart speed of 50 percent. When you are stationary and a fish swims through the

sonar signal cone, the image appears on the screen as a long line instead of a fish arch. Reducing the chart speed may result in a shorter line that more closely resembles a regular fish return.

To adjust Chart Speed, repeatedly press **MENU** until the **CHART SPEED** scroll bar appears. Press **↑** to increase the speed of the chart. Press **↓** to decrease it. Press **PWR** to clear the menu.

To return to the original setting, repeat the steps above, but use the arrow keys to set the speed to **100%** before clearing the menu.

Frequency

Your sonar unit can transmit signals at 83 kHz and 200 kHz. The default frequency is 200 kHz, best used in shallow water (about 300 feet or less). This frequency is the best choice for about 80 percent of the fresh and salt water sport fishing applications. When you get into very deep salt water, up to 1,000 feet, the 83 kHz frequency will work best.

The 200 kHz transducer will give you better detail and definition, but less depth penetration. You will not get as much detail or definition with the 83 kHz frequency, but it has greater depth penetration and up to 120° of wide fishingfinding coverage. Remember, all sonar units typically read deeper in fresh water than in salt water.

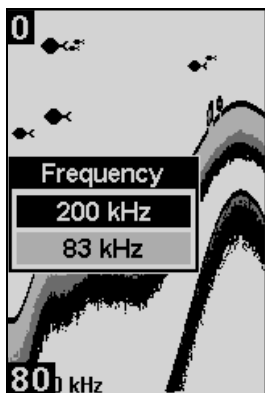

Frequency menu with 200 kHz selected.

To switch the Frequency, repeatedly press **MENU** until the Frequency menu appears. Press **↑** to select **200 kHz** or press **↓** to choose **83 kHz**. Press **PWR** to clear the Frequency menu from the screen.

Fish I.D.™

The Fish I.D.™ feature displays — as fish — targets that meet certain conditions. The microcomputer analyzes all echoes and eliminates surface clutter, thermoclines and other undesirable signals.

The Fish I.D. feature displays symbols on the screen in place of the actual fish echoes. There are three symbol sizes: small, medium and large. These show the relative size between targets. In other words, it displays a small fish symbol when it thinks a target is a small fish, a medium fish symbol on a larger target and so forth.

Fish I.D. is an easier way for a sonar novice to recognize a fish signal return when he sees it. But, locating fish by symbol *only* does have some limitations.

Your sonar unit's microcomputer is sophisticated, but it can be fooled. It can not distinguish between fish and other suspended objects such as trotlines, turtles, submerged floats, air bubbles, etc. Individual tree limbs extending outward from a group of limbs are the hardest objects for the Fish I.D. feature to distinguish from fish.

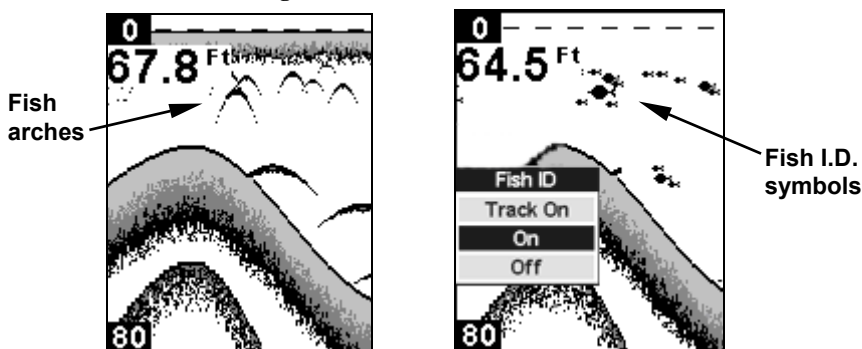

Underwater scene in normal fish arch mode (left). Fish I.D. menu with the feature turned on (right).

To see what is under your boat in maximum detail, we recommend you turn off Fish I.D. and begin learning to interpret fish arches.

You may see Fish I.D. symbols on the screen when actually, there are no fish. The reverse is also true — Fish I.D. can actually miss fish that are present. Does that mean Fish I.D. is broken? No — the feature is interpreting sonar returns in a specific way to help take some of the work out of reading the screen. Remember: Fish I.D. is one of the many tools we provide so you can analyze your sonar returns for maximum fish finding information. This and other features can help you "see" beneath the boat under varied water and fishing conditions. So, practice with the unit in both the Fish I.D. mode and without to become more familiar with the feature. This unit's default Fish I.D. setting is on.

Fish I.D. is most handy when you are in another part of the boat or performing some task that prevents you from watching the sonar screen. Then, you can turn on Fish I.D. and the audible fish alarm. When that lunker swims under your boat, you will hear it!

Fish I.D. can also be useful when you want to screen out some of the sonar detail gathered by your unit. For example, it can help cut through the clutter of suspended bubbles caused by wave action or boat wakes.

To turn Fish I.D. off, repeatedly press **MENU** until the **FISH ID** menu appears. Press **↓** to select **OFF**, then press **PWR**. To turn it back on, repeat the above steps, but press **↑** to select **ON**.

FishTrack™

The FishTrack™ feature shows the depth of a fish symbol when it appears on the display. To turn it on, repeatedly press **MENU** until the **FISH ID** menu appears. Press **↑** to select **TRACK ON**, then press **PWR**. To turn it off, repeat the steps above, but press **↓** to select **OFF**.

If you want to turn off FishTrack depths but leave Fish I.D. on, press **↓** to select **ON**, then press **PWR**. Remember, Fish I.D. must be on in order to use the FishTrack feature.

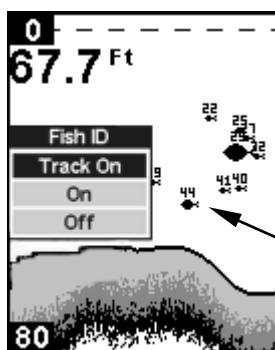

Fish I.D. symbols showing FishTrack depth indicator

Fish ID menu and symbol with FishTrack on. The fish is 44 feet deep.

Alarms

The sonar unit has four types of alarms: fish, shallow, deep and battery.

Fish Alarm

The Fish Alarm sounds a tone when a fish symbol appears on the screen. The Fish I.D. feature must be turned on for fish alarms to work.

To turn on Fish I.D., repeatedly press **MENU** until the **FISH ID** menu appears. Press **↓** to select **ON**, then press **PWR**. Repeatedly press **MENU** until the **FISH ALARM** menu appears. Press **↑** to select **ON**, then press **PWR**.

To turn off fish alarm repeatedly press **MENU** until the **FISH ALARM** menu appears. Press **↓** to select **OFF**, then press **PWR** to clear the menu.



Fish Alarm menu.

Depth Alarms

The depth alarms are triggered only by the bottom signal. No other echoes will activate these alarms. The depth alarms consist of a shallow and a deep alarm. The shallow alarm sounds an alarm tone when the bottom goes shallower than the alarm's setting. The deep alarm sounds a tone when the bottom goes deeper than its setting. Both alarms adjust the same way, although through different menus.

Shallow Alarm

To set the shallow alarm depth, repeatedly press **MENU** until **SHALLOW ALARM** appears.

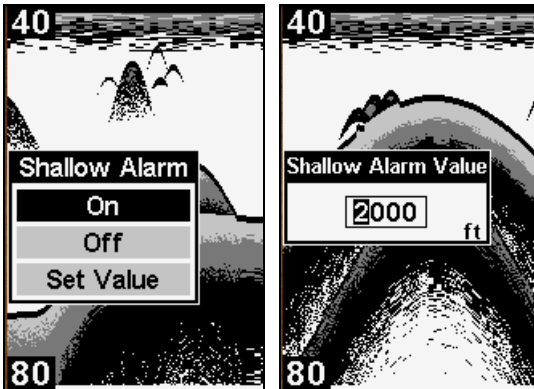

Shallow Alarm menu (left). Shallow Alarm Value Dialog box (right).

Press \downarrow to **SET VALUE**. The Shallow Alarm Value dialog box will appear. Use \uparrow \downarrow to enter the first number in the dialog box, then press **MENU DOWN** to move to the next digit. Repeat those steps until the desired depth has been entered in the dialog box. To move the cursor back to

any of the previously entered numbers, press **MENU UP**. Press **PWR** to return to the Shallow Alarm menu. Use **↑** to select **ON**, which will turn on the alarm, then press **PWR** to clear the menu. When the bottom depth becomes more shallow than the alarm's setting, an alarm will sound and a message will appear on the screen.

Press **PWR** to silence the alarm. It will remain silent until it is triggered again.

To turn off the alarm, repeatedly press **MENU** until the **SHALLOW ALARM** menu appears. Press **↓** to **OFF**, then press **PWR** to clear the menu.

Deep Alarm

To set the deep alarm depth, repeatedly press **MENU** until **DEEP ALARM** appears.

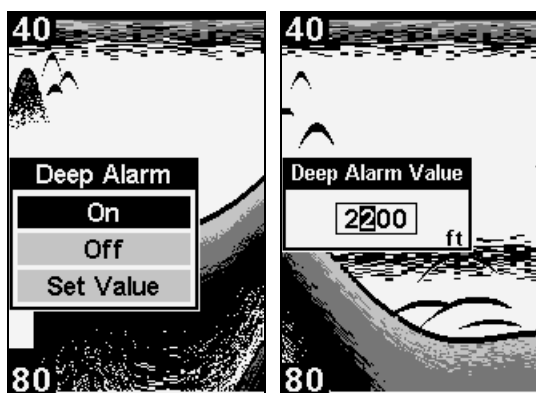

Deep Alarm menu (left). Deep Alarm dialog box (right).

Press the **↓** to **SET VALUE**. The Deep Alarm Value dialog box will appear. Use **↓** to enter the first number in the dialog box, then press **MENU DOWN** to move to the next digit. Repeat those steps until the desired depth has been entered in the dialog box. To move the cursor back to any of the previously entered numbers, press **MENU UP**. Press **PWR** to return to the Deep Alarm menu. Press **↑** to select **ON**, which will turn on the alarm, then press **PWR** to clear the menu. When the bottom depth becomes deeper than the alarm's setting, an alarm will sound and a message will appear on the screen.

Battery Alarm

To set the battery alarm depth, repeatedly press **MENU** until **BATTERY ALARM** appears.

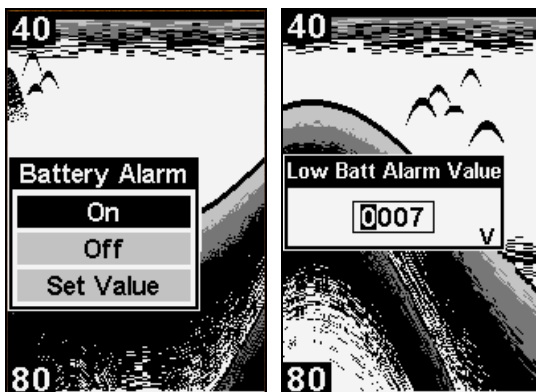

Battery Alarm menu (left). Low Battery Alarm Value (right).

Press the \downarrow to **SET VALUE**. The Low Battery Alarm Value dialog box will appear. Input a voltage value between 7 and 18 volts. Use the $\uparrow\downarrow$ keys to enter the first number in the dialog box, then press **MENU DOWN** to move to the next digit. Repeat those steps until the desired value has been entered in the dialog box. To move the cursor back to any of the previously entered numbers, press **MENU UP**. Press **PWR** to return to the Battery Alarm menu. Use \uparrow to select **ON**, which will turn on the alarm, then press **PWR** to clear the menu. If the voltage value falls below the alarm's setting, the alarm will sound and a message will appear on the screen.

Noise Rejection and ASP™

The ASP™ (Advanced Signal Processing) feature is a noise rejection system built into the sonar unit. It constantly evaluates the effects of boat speed, water conditions and electrical interference and automatically gives you the best display possible under most conditions.

ASP is an effective tool in combating noise. In sonar terms, noise is any undesired signal. It is caused by electrical and mechanical sources such as bilge pumps, engine ignition systems, wiring, air bubbles passing over the face of the transducer and even vibration from the engine. In all cases, noise can produce unwanted marks on the display.

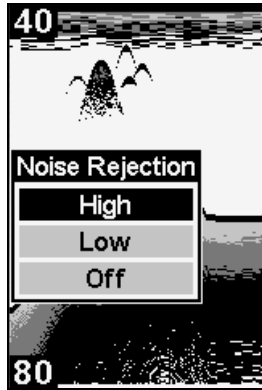

Noise Rejection menu.

The ASP noise rejection feature is especially useful because, typically, it lets you operate the boat at all speeds without adjusting the sensitivity or other controls.

The ASP feature has three settings — Off, Low and High. When first turned on, noise rejection is set on low. If you have high noise levels, try using the high ASP setting. If, however, you are having trouble with noise, we suggest you take steps to find the interference source and fix it, rather than continually using the unit with the high ASP setting. There are times when you may want to turn off ASP. This allows you to view all incoming echoes before they are processed by the ASP feature.

To change the ASP setting, repeatedly press **MENU** until the **NOISE REJECTION** menu appears. Use \uparrow \downarrow to select the desired setting, then press **PWR** to clear the menu.

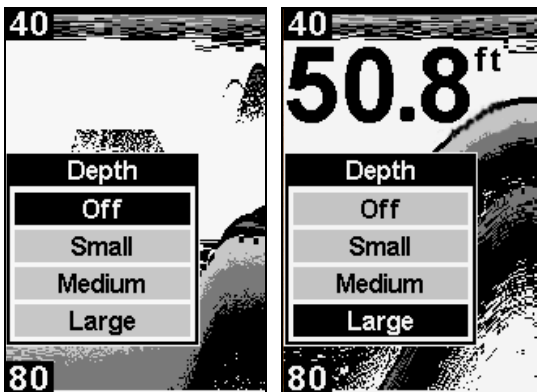

**Depth menu with Depth display turned off (left).
Depth display set to Large (right).**

Depth Display

Depth may be displayed on the screen in a small, medium or large size or can be turned off completely.

To display Depth:

Repeatedly press **MENU** until the **DEPTH** menu appears. Use $\uparrow\downarrow$ to select the size of the depth display. Press **PWR** to clear the menu.

Temperature Display

Temperature may be displayed on the screen in a small or medium size or can be turned off completely.

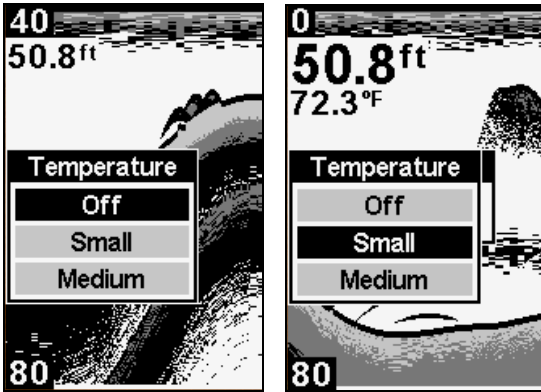

Temperature menu (left). Temperature display set to small size (right).

To display Temperature:

Repeatedly press **MENU** until the **TEMPERATURE** menu appears. Use $\uparrow\downarrow$ to select the size of the temperature display. Press **PWR** to clear the menu.

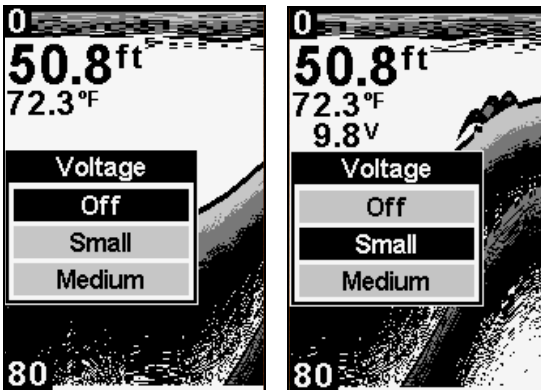

Voltage menu with the voltage display turned off (left) and with voltage set to a small display size (right).

Voltage

The Voltage menu allows you to display battery voltage on the screen in a small or medium size or can be turned off completely.

To display battery voltage:

Repeatedly press **MENU** until the **VOLTAGE** menu appears. Use \uparrow \downarrow to select the size of the voltage display. Press **PWR** to clear the menu.

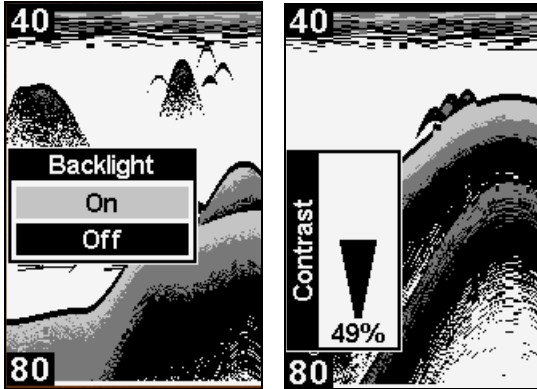

Backlight turned on (left). Contrast scroll bar (right).

Backlight

The display's backlight allows the unit to be used at night. To turn the backlight on or off, repeatedly press **MENU** until the **BACKLIGHT** menu appears. Press \uparrow to turn on the light or \downarrow to turn it off. Press **PWR** to clear the backlight menu from the display.

Contrast

The unit's display contrast is adjustable to suit different lighting conditions. It will help you see the screen from different angles or at various times of the day.

To adjust the contrast, repeatedly press **MENU** until the **CONTRAST** scroll bar appears. To decrease screen contrast, press \downarrow or press \uparrow to increase the contrast. If you reach the maximum or minimum contrast level, a tone will sound. Press the **PWR** key to clear the menu.

Simulator

This unit has a built-in simulator that shows a simulated bottom signal with fish signals. This lets you practice with the unit as if you were on the water; all features and functions of the unit are usable. A message appears occasionally to remind you that the simulator is on.

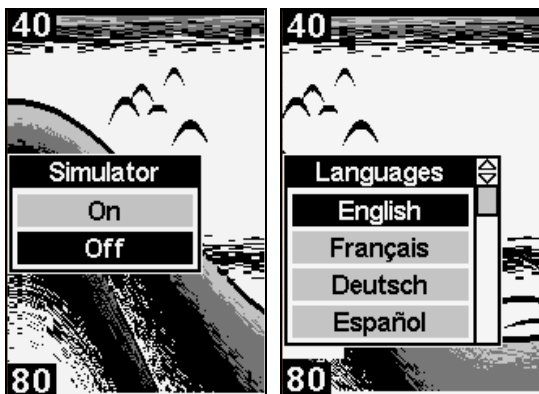

Simulator menu (left). Languages menu (right).

To use the simulator, repeatedly press **MENU** until the **SIMULATOR** menu appears. Press **↑** to turn it on and press **PWR** to clear the menu. Repeat the steps above to turn it off. The simulator automatically will be turned off when you power off the unit.

Set Language

This unit's menus are available in 11 languages: English, French, German, Spanish, Italian, Danish, Swedish, Russian, Czech, Dutch and Finnish.

To select a language:

1. Repeatedly press **MENU** until the Languages menu appears.
2. Use **↑ ↓** to select the desired language. All menus now appear in the language you selected. Press **PWR** to clear the menu from the screen.

Software Information

To show the unit's software system information, repeatedly press **MENU** until the **SOFTWARE INFORMATION** screen appears. Press **PWR** to clear the screen.

Reset Options

This command is used to reset all features, options and settings to their original factory defaults. This is useful when you have changed several settings and want to reset the unit to basic automatic operation.

First, turn off the unit. Next, press and hold **↓** and the **MENU DOWN** key at the same time, then press the **PWR** key. Release the keys as the unit powers up. The unit will turn on with the factory settings restored.

Troubleshooting

If your unit is not working, or if you need technical help, please use the following troubleshooting section before contacting the factory customer service department. It may save you the trouble of returning your unit for repair. For contact information, refer to the last page, just inside the back cover of this manual.

Unit won't turn on:

1. Check the power cable's connection at the unit. Also check the wiring.
2. Make certain the power cable is wired properly. The red wire connects to the positive battery terminal, black to negative or ground.
3. Check the fuse.
4. Measure the battery voltage at the unit's power connector. It should be at least 11 volts. If it isn't, the wiring to the unit is defective, the battery terminals or wiring on the terminals are corroded, or the battery needs charging.

Unit turns on only in simulator mode:

There is a problem with the transducer or the transducer cable. Check the cable for damage.

Unit freezes, locks up, or operates erratically:

1. Electrical noise from the boat's motor, trolling motor, or an accessory may be interfering with the sonar unit. Rerouting the power and transducer cables away from other electrical wiring on the boat may help. Route the sonar unit's power cable directly to the battery instead of through a fuse block or ignition switch.
2. Inspect the transducer cable for breaks, cuts, or pinched wires.
3. Check both the transducer and power connectors. Make certain both are securely plugged in to the unit.

Weak bottom echo, digital readings erratic, or no fish signals:

1. Make certain the transducer is pointing straight down. Clean the face of the transducer. Oil, dirt and fuel can cause a film to form on the transducer, reducing its effectiveness. If the transducer is mounted inside the hull, be sure it is shooting through only one layer of fiberglass and that it is securely bonded to the hull. Do NOT use RTV silicone rubber adhesive or Marine-Tex™ epoxy.
2. Electrical noise from the boat's motor can interfere with the sonar. This causes the sonar to automatically increase its Discrimination or noise rejection feature. This can cause the unit to eliminate weaker signals such as fish or even structure from the display.

3. The water may be deeper than the sonar's ability to find the bottom. If the sonar can't find the bottom signal while it's in the automatic mode, the digital sonar display will flash continuously. It may change the range to limits far greater than the water you are in. If this happens, place the unit in the manual mode, then change the range to a realistic one, (for example, 0-100 feet) and increase the sensitivity. As you move into shallower water, a bottom signal should appear.

4. Check the battery voltage. If the voltage drops, the unit's transmitter power also drops, reducing its ability to find the bottom or targets.

Bottom echo disappears at high speeds or erratic digital reading or weak bottom echo while boat is moving

1. The transducer may be in turbulent water. It must be mounted in a smooth flow of water in order for the sonar to work at all boat speeds. Air bubbles in the water disrupt the sonar signals, interfering with its ability to find the bottom or other targets. The technical term for this is cavitation.

2. Electrical noise from the boat's motor can interfere with the sonar. This causes the sonar to automatically increase its Discrimination or noise rejection feature. This can cause the unit to eliminate weaker signals such as fish or even structure from the display.

Try using resistor spark plugs or routing the sonar unit's power and transducer cables away from other electrical wiring on the boat.

No fish arches when the Fish I.D. feature is off:

1. Make certain the transducer is pointing straight down. This is the most common problem if a partial arch is displayed.

2. The sensitivity may not be high enough. In order for the unit to display a fish arch, it has to be able to receive the fish's echo from the time it enters the cone until it leaves. If the sensitivity is not high enough, the unit shows the fish only when it is in the center of the cone.

3. Use the Zoom feature. It is much easier to display fish arches when zoomed in on a small range of water than a large one. For example, you will have much better luck seeing fish arches with a 30 to 60 foot range than a 0 to 60 foot range. This enlarges the targets, allowing the display to show much more detail.

4. The boat must be moving at a slow trolling speed to see fish arches. If the boat is motionless, fish stay in the cone, showing on the screen as straight horizontal lines.

NOISE

A major cause of sonar problems is electrical noise. This usually appears on the sonar's display as random patterns of dots or lines. In se-

vere cases, it can completely cover the screen with black dots, or cause the unit operate erratically, or not at all.

To eliminate or minimize the effects of electrical noise, first try to determine the cause. With the boat at rest in the water, the first thing you should do is turn all electrical equipment on the boat off. Make sure the engine is also off. Turn your sonar on, then turn off Noise Reject [also known as the ASP feature (Advanced Signal Processing)]. Sensitivity should be set at 90-95 percent. There should be a steady bottom signal on the display. Now turn on each piece of electrical equipment on the boat and view the effect on the sonar's display. For example, turn on the bilge pump and view the sonar display for noise. If no noise is present, turn the pump off, then turn on the VHF radio and transmit. Keep doing this until all electrical equipment has been turned on, their effect on the sonar display noted, then turned off.

If you find noise interference from an electrical instrument, trolling motor, pump, or radio, try to isolate the problem. You can usually reroute the sonar unit's power cable and transducer cable away from the wiring that is causing the interference. VHF radio antenna cables radiate noise when transmitting, so be certain to keep the sonar's wires away from it. You may need to route the sonar unit's power cable directly to the battery to isolate it from other wiring on the boat.

If no noise displays on the sonar unit from electrical equipment, then make certain everything except the sonar unit is turned off, then start the engine. Increase the RPM with the gearshift in neutral. If noise appears on the display, the problem could be one of three things; spark plugs, alternator, or tachometer wiring. Try using resistor spark plugs, alternator filters, or routing the sonar unit's power cable away from engine wiring. Again, routing the power cable directly to the battery helps eliminate noise problems. Make certain to use the in-line fuse supplied with the unit when wiring the power cable to the battery.

When no noise appears on the sonar unit after all of the above tests, then the noise source is probably cavitation. Many novices or persons with limited experience make hasty sonar installations which function perfectly in shallow water, or when the boat is at rest. In nearly all cases, the cause of the malfunction will be the location and/or angle of the transducer. The face of the transducer must be placed in a location that has a smooth flow of water at all boat speeds. Read your transducer owner's manual for the best mounting position.

LOWRANCE ELECTRONICS FULL ONE-YEAR WARRANTY

"We," "our," or "us" refers to LOWRANCE ELECTRONICS, a division of LEI, the manufacturer of this product. "You" or "your" refers to the first person who purchases this product as a consumer item for personal, family, or household use.

We warrant this product against defects or malfunctions in materials and workmanship, and against failure to conform to this product's written specifications, all for one (1) year from the date of original purchase by you. **WE MAKE NO OTHER EXPRESS WARRANTY OR REPRESENTATION OF ANY KIND WHATSOEVER CONCERNING THIS PRODUCT.** Your remedies under this warranty will be available so long as you can show in a reasonable manner that any defect or malfunction in materials or workmanship, or any non-conformity with the product's written specifications, occurred within one year from the date of your original purchase, which must be substantiated by a dated sales receipt or sales slip. Any such defect, malfunction, or non-conformity which occurs within one year from your original purchase date will either be repaired without charge or be replaced with a new product identical or reasonably equivalent to this product, at our option, within a reasonable time after our receipt of the product. If such defect, malfunction, or non-conformity remains after a reasonable number of attempts to repair by us, you may elect to obtain without charge a replacement of the product or a refund for the product. **THIS REPAIR, OR REPLACEMENT OR REFUND (AS JUST DESCRIBED) IS THE EXCLUSIVE REMEDY AVAILABLE TO YOU AGAINST US FOR ANY DEFECT, MALFUNCTION, OR NON-CONFORMITY CONCERNING THE PRODUCT OR FOR ANY LOSS OR DAMAGE RESULTING FROM ANY OTHER CAUSE WHATSOEVER. WE WILL NOT UNDER ANY CIRCUMSTANCES BE LIABLE TO ANYONE FOR ANY SPECIAL, CONSEQUENTIAL, INCIDENTAL, OR OTHER INDIRECT DAMAGE OF ANY KIND.**

Some states do not allow the exclusion or limitation of incidental or consequential damages, so the above limitations or exclusions may not apply to you.

This warranty does NOT apply in the following circumstances: (1) when the product has been serviced or repaired by anyone other than us; (2) when the product has been connected, installed, combined, altered, adjusted, or handled in a manner other than according to the instructions furnished with the product; (3) when any serial number has been effaced, altered, or removed; or (4) when any defect, problem, loss, or damage has resulted from any accident, misuse, negligence, or carelessness, or from any failure to provide reasonable and necessary maintenance in accordance with the instructions of the owner's manual for the product.

We reserve the right to make changes or improvements in our products from time to time without incurring the obligation to install such improvements or changes on equipment or items previously manufactured.

This warranty gives you specific legal rights and you may also have other rights which may vary from state to state.

REMINDER: You must retain the sales slip or sales receipt proving the date of your original purchase in case warranty service is ever required.

**LOWRANCE ELECTRONICS
PO BOX 669, CATOOSA, OK 74015
(800) 324-1354**

How to Obtain Service...

...in the USA:

We back your investment in quality products with quick, expert service and genuine Lowrance replacement parts. If you're in the United States and you have technical, return or repair questions, please contact the Factory Customer Service Department. Before any product can be returned, you must call customer service to determine if a return is necessary. Many times, customer service can resolve your problem over the phone without sending your product to the factory. To call us, use the following toll-free number:

800-324-1354

8 a.m. to 5 p.m. Central Standard Time, M-F

Lowrance Electronics may find it necessary to change or end our shipping policies, regulations, and special offers at any time. We reserve the right to do so without notice.

...in Canada:

If you're in Canada and you have technical, return or repair questions, please contact the Factory Customer Service Department. Before any product can be returned, you must call customer service to determine if a return is necessary. Many times, customer service can resolve your problem over the phone without sending your product to the factory. To call us, use the following toll-free number:

800-661-3983

905-629-1614 (not toll-free)

8 a.m. to 5 p.m. Eastern Standard Time, M-F

...outside Canada and the USA:

If you have technical, return or repair questions, contact the dealer in the country where you purchased your unit. To locate a dealer near you, visit our web site, www.lowrance.com and look for the Dealer Locator.

Accessory Ordering Information for all countries

To order Lowrance GPS accessories such as computer cables or MMC cards, please contact:

1) Your local marine dealer or consumer electronics store. Most quality dealers that handle marine electronic equipment or other consumer electronics should be able to assist you with these items.

To locate a Lowrance dealer near you, visit our web site, www.lowrance.com and look for the Dealer Locator. Or, you can consult your telephone directory for listings.

2) U.S. customers: LEI Extras Inc., PO Box 129, Catoosa, OK 74015-0129
Call 1-800-324-0045 or visit our web site www.lei-extras.com.

3) Canadian customers can write:

Lowrance/Eagle Canada, 919 Matheson Blvd. E. Mississauga, Ontario L4W2R7 or fax 905-629-3118.

Shipping Information

If it becomes necessary to send a product for repair or replacement, you must first receive a return authorization number from Customer Service. Products shipped without a return authorization will not be accepted. When shipping, we recommend you do the following:

1. Always use the original shipping container and filler material the product was packed in.
2. Always insure the parcel against damage or loss during shipment. Lowrance does not assume responsibility for goods lost or damaged in transit.
3. For proper testing, include a brief note with the product describing the problem. Be sure to include your name, return shipping address and a daytime telephone number.

Visit our web site:



L[®] LOWRANCE

We Lead, We Find, You Win.[™]

Lowrance Pub. 988-0151-431

Printed in USA 032106

© Copyright 2006
All Rights Reserved
Lowrance Electronics, Inc.

Free Manuals Download Website

<http://myh66.com>

<http://usermanuals.us>

<http://www.somanuals.com>

<http://www.4manuals.cc>

<http://www.manual-lib.com>

<http://www.404manual.com>

<http://www.luxmanual.com>

<http://aubethermostatmanual.com>

Golf course search by state

<http://golfingnear.com>

Email search by domain

<http://emailbydomain.com>

Auto manuals search

<http://auto.somanuals.com>

TV manuals search

<http://tv.somanuals.com>