



LCX-15_{ci}™

and

LCX-15_{CT}™

**INSTALLATION AND
OPERATION INSTRUCTIONS**

L[®] LOWRANCE

WWW.LOWRANCE.COM

Copyright © 2000, 2002 Lowrance Electronics, Inc.
All rights reserved.

LCX-15CI and LCX-15CT are trademarks of Lowrance Electronics, Inc.

Lowrance® is a registered trademark of Lowrance Electronics, Inc.

WARNING!

USE THIS UNIT ONLY AS AN AID TO NAVIGATION. A CAREFUL NAVIGATOR NEVER RELIES ON ONLY ONE METHOD TO OBTAIN POSITION INFORMATION.

Never use this product while operating a vehicle.

CAUTION

When showing navigation data to a position (waypoint), this unit will show the shortest, most direct path to the waypoint. It provides navigation data to the waypoint regardless of obstructions. Therefore, the prudent navigator will not only take advantage of all available navigation tools when travelling to a waypoint, but will also visually check to make certain a clear, safe path to the waypoint is always available.

The operating and storage temperature for your unit is from -4 degrees to +167 degrees Fahrenheit (-20 to +75 degrees Celsius). Extended storage temperatures higher or lower than specified will cause the liquid crystal display to fail. Neither this type of failure nor its consequences are covered by the warranty. For more information, consult the factory customer service department.

All features and specifications subject to change without notice.

Lowrance Electronics may find it necessary to change or end our policies, regulations, and special offers at any time. We reserve the right to do so without notice.

All screens in this manual are simulated.

NOTICE!

Free software upgrades will be available on our website at <http://www.lowrance.com/lcx> as they are released. Please check our website periodically for these and other information as they become available.

Thank you for choosing Lowrance!

This device complies with Part 15 of the FCC Rules. Operation is subject to the following two conditions: (1) this device may not cause harmful interference, and (2) this device must accept any interference received, including interference that may cause undesired operation.

Note:

This equipment has been tested and found to comply with the limits for a Class B digital device, pursuant to Part 15 of the FCC Rules. These limits are designed to provide reasonable protection against harmful interference in a residential installation. This equipment generates, uses and can radiate radio frequency energy and, if not installed and used in accordance with the instructions, may cause harmful interference to radio communications. However, there is no guarantee that interference will not occur in a particular installation. If this equipment does cause harmful interference to radio or television reception, which can be determined by turning the equipment off and on, the user is encouraged to try to correct the interference by one or more of the following measures:

- Reorient or relocate the receiving antenna.
- Increase the separation between the equipment and receiver.
- Connect the equipment into an outlet on a circuit different from that to which the receiver is connected.
- Consult the factory customer service department for help.



SPECIFICATIONS

Dimensions (on bracket)	9.6" W x 7.3" H x 3.7" D
Input Voltage	10 - 15 vDC, 12-volt Nominal
Transmitter Frequency	200 kHz and 50 kHz
Maximum Output Power	200 kHz - 500 watts (RMS) 50 kHz - 1,000 watts (RMS)
Operating and Storage Temperature	-4 to +167 degrees Fahrenheit -20 to +75 degrees Celsius
Waypoint	750
Routes	100
Icons	1000
NMEA 2.0 GPS Sentences	GLL, GGA, APB, RMB, RMC, GSA, GSV
NMEA 2.0 Sonar Sentences	DBT, DPT, MTW, VLW, VHW

Table of Contents

INTRODUCTION	1	GPS OPERATION	28
ACCESSORIES	1	Introduction to GPS	28
TRANSDUCERS	1	Finding Your Position	30
INSTALLATION	2	Auto Search	30
Mounting	2	Manual Initialization	30
Power Connections	3	Position Acquisition	31
NMEA/DGPS Wiring	4	Require DGPS	32
Accessory Connections	5	PAGES	32
Speed/Temperature Sensor	5	Status Screen	32
MMC	7	Customizing the Status Screen	33
KEYBOARD	8	Navigation Screen	33
SONAR OPERATION	9	Customizing the Navigation Screen	34
Pages	9	Map	34
Full Sonar Chart	9	Full Map	35
Split Zoom Chart	10	Digital Data	35
Split Frequency Sonar Chart	10	Two Position Formats	36
Digital/Chart	10	Two Maps	36
Customizing the Digital/Chart Screen	11	Map with Sonar	36
Menus	11	Cursor	36
Sonar Options	12	Cursor Distance	37
Sensitivity	12	Map Orientation	37
Automatic Sensitivity	12	Auto Zoom	39
ColorLine	13	Range Rings/Grid Lines	39
Range - Automatic	13	Map Data	39
Manual	14	Map Categories Drawn	40
Range - Upper/Lower Limits	14	Icons	40
Zoom	15	Plot Trail	41
Chart Stop	15	Edit Trail	42
Chart Speed	15	Navigate a Trail	42
Depth Cursor	15	Trail Options	44
Chart Data	16	New Trail	44
Sonar Features	16	Delete All Trails	44
Transducer Frequency	17	Waypoints	45
Surface Clarity	17	Saving Present Position	45
Noise Rejection	17	Saving Cursor Position	45
Fish Symbols/Fish Depths	18	Saving a New Position	46
Log Sonar Chart Data	19	Edit Waypoint	46
Display Settings	19	Average Position	47
Contrast/Backlight/Display Mode	19	Waypoint Information	47
Audio	20	Waypoint Navigation	48
Alarms	20	Navigate to Cursor	48
Depth Alarms	21	Navigate to Waypoint using Map	48
Zone Alarm	21	Man Overboard	49
Fish Alarm	22	Cancel Navigation	50
Sonar Setup	22	Routes	50
Transducer Type	22	Create a Route	51
Keel Offset	23	Follow a Route	53
Calibrate Speed	23	GPS Simulator	53
Reset Water Distance	23	GPS Setup	54
Sonar Simulator	24	Coordinate System	54
System Setup	24	Map Fix	55
Units of Measure	24	Datum	56
Set Local Time	25	Position Pinning	57
Communication Ports	25	GPS Alarms	58
Configure DGPS	26	Trip Calculator	59
Configure NMEA	26	Timers/Alarm Clock	59
Reset Options	26	Sonar Troubleshooting	60
Popup Help	27	Warranty Information	63
Hide GPS Features	27	Datum List	64
Software Information	27	Database License Agreement	67
Sun/Moon Calculator	27	Database Limited Warranty	68
		Saving and Replaying a Sonar Record	69
		Transferring GPS Data to/from a MMC	70

INTRODUCTION

Thank you for purchasing a Lowrance product. This manual covers both the LCX-15CI and LCX-15CT. The liquid crystal display (LCD) is the only difference between these two units.

The LCX-15CI and LCX-15CT are sold with many different accessories. Some are packed with a GPS receiver, MMC, and mapping CD-ROM. Others are sold only with a transducer. Many may come with different combinations of accessories.

Please note that you may need to purchase accessories in order to use all of the features of this product that are described in this manual. A list of the accessories and transducers is shown below.

ACCESSORIES	Model	Part #
Gimbal Knobs	GK-9	101-80
Gimbal Bracket	GB-12	101-78
Power Cable	PC-21X	99-56
Protective Cover	CVR-1	101-82
Sun Shade	SS-1	101-83
MMC Drawer	MMCD-1	101-84
MMC Interface	MMCI	101-85
Cigarette Adapter Cable	CA-4	99-59
Power Connector Repair Kit	TC-4X	101-86
MMC Card 8MB	MMC-8	101-87
MMC Card 16MB	MMC-16	101-88
Transducer Extension Cable (12')	XT-12	99-57
Transducer Extension Cable (20')	XT-20X	99-58
Speed/Temp Y-adapter Cable	MY-4X	99-53
Speed/Temp Sensor w/ MY-4X	ST-TX	99-54
Temp Sensor 1 w/ MY-4X	TS-1X	99-50
Temp Sensor 2	TS-2X	99-51
Temp Sensor 3	TS-3X	99-52

Transducers

	Model	Part #
200 kHz "Skimmer"	HS-WSDX	106-22
High Speed Transom mount w/temp sensor		
200 kHz "Pod" Transducer	PD-WDXT	106-26
w/temp sensor for trolling motor application		

Transducers (cont.)

	Model	Part #
200 kHz "Pod" Transducer w/o temp for shoot-thru hull	PD-WDX	106-27
50/200 kHz Dual Freq. "Skimmer" High Speed Transom mount with temp sensor	HS-50/200-DX	106-23
50/200 kHz Dual Freq. Bronze thru-hull mount w/temp and speed sensor	THST-50/200-DX	106-29

INSTALLATION

Bracket

Install the unit in any convenient location, provided there is clearance behind it when it is tilted for the best viewing angle. Holes in the bracket base allow wood screw or through-bolt mounting. Make certain there is enough room behind the unit to attach the power and other cables.

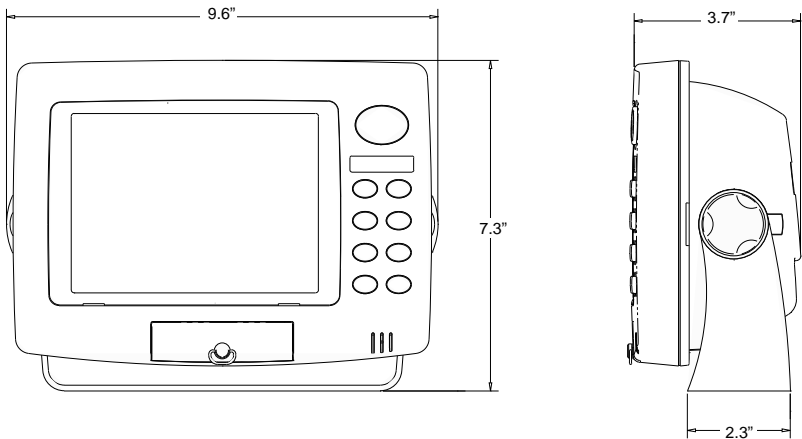

Once the best location is determined, use the bracket as a template and mark the mounting holes and the hole for the cables. Drill a 1.0" hole for the cables. Screw the bracket to the mounting surface.

IMPORTANT!

In order to pass all connectors through the 1" hole in the bracket and dash, first pass the transducer connector up through the hole, then any accessory cables. Next, pass the power cable down through the hole. Fill the hole with a marine sealant. You can now wire the power cable.

Power Connections

This unit operates from a 12-volt battery system. For the best results, connect the power cable to the in-line fuse holder and attach it directly to the battery. The power cable can be attached to an accessory or power buss, however there could be problems with electrical interference using this method. Therefore, it's better from a noise standpoint to attach the power cable and fuse holder directly to a battery. If the cable is not long enough, splice 16-gauge wire onto it.

The power connector has two cables attached to it. One cable has the power and ground wires, the other is for the NMEA/DGPS interface. See below for NMEA/DGPS wiring instructions. The power cable has two wires - red and black. The black wire connects to the battery's negative terminal. The red wire is the positive wire. Connect it to the fuse holder supplied with the unit. Connect the other end of the fuse holder to the positive side of the battery. Make certain to attach the fuse holder directly to the battery. This will protect the both cable and the unit in case there is a short circuit. Use a 6-amp fuse.

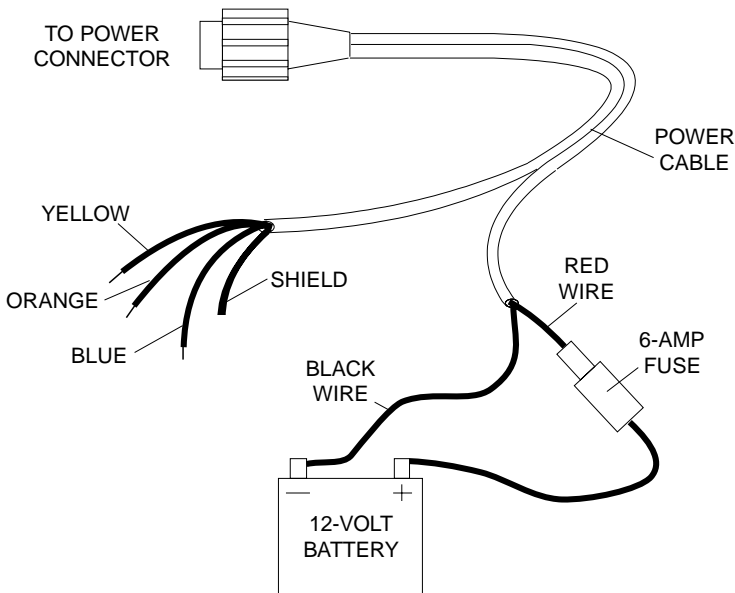

IMPORTANT!

Do not use this product without a 6-amp fuse connected to the power cable! Failure to use a fuse will void your warranty.

To prevent electrical interference, route the power, transducer, and GPS cables away from other wiring, especially the engine's wiring harness. VHF radio antenna cables radiate noise when transmitting, so be certain to keep the unit's wires away from it, also.

NMEA/DGPS

NMEA is a standard communications format for marine electronic equipment. For example, an autopilot can connect to the NMEA interface on the LCX-15CI/15CT and receive positioning information.

DGPS is an acronym for Differential Global Positioning System. The most popular DGPS system relies on a grid of ground-based transmitters that send correction signals to DGPS receivers. These in turn, connect to the GPS receiver (such as the LCX-15CI/15CT with the LGC-12S GPS module). This gives more accurate positions than is otherwise possible.

NMEA/DGPS Wiring

The LCX-15CI/15CT has two NMEA 0183 version 2.0 ports. Com port one can be used for either NMEA or DGPS, Com port two is for NMEA output only.

Communications port one uses the yellow wire for transmit, the orange wire for receive. Communications port two uses the blue wire for transmit. Both ports use the shield wire for signal ground.

See the diagrams below for general wiring connections. Read your other product's owner's manual for more wiring information.

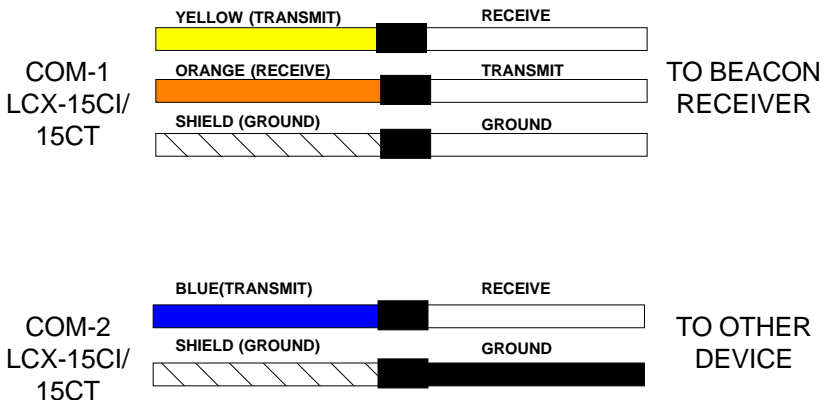

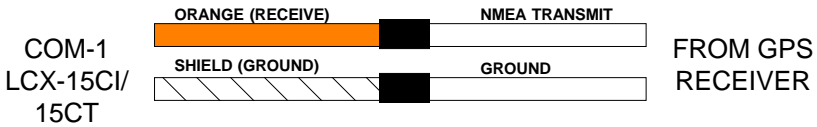

The LCX-15CI/15CT can accept position information from any GPS receiver that transmits NMEA 0183 data. Use the wiring diagram shown above for NMEA input to the LCX-15CI/15CT.

See page 25 and 26 for NMEA and DGPS com port setup instructions.

Accessory Connections

The rear of this unit has three connectors: Power/Data, GPS, and Transducer. The power cable connects to the Power/Data connector, the cable from the GPS module goes to the GPS connector, and the transducer plugs into the Transducer connector.

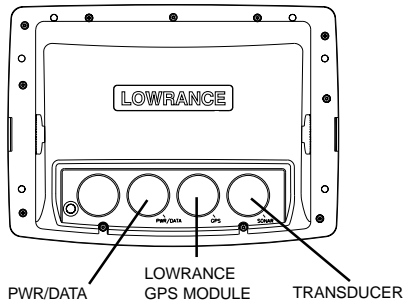

Speed/Temperature Connections

This unit can use a speed sensor in addition to up to three temperature sensors.

All transom-mount “Skimmer” transducers have a temperature sensor built into them. To add another temperature sensor besides the one in the transducer requires a MY-4X “Y” adapter cable and a TS-2X temperature sensor. The transducer plugs into one end of the MY-4X, the TS-2X temperature sensor plugs into another, and the last end plugs into the SONAR port. The TS-2X temperature sensor has an extra connector for a TS-3X temperature sensor. This lets you have three temperature sensors, if desired.

Note: Do not combine the temperature sensors in any order other than shown on the next page. For example, do not use two TS-3X temperature sensors in place of one TS-2X and one TS-3X sensors. Each sensor is programmed to work only on the channel it’s designed for.

Temperature and Speed/Temperature Installation Examples

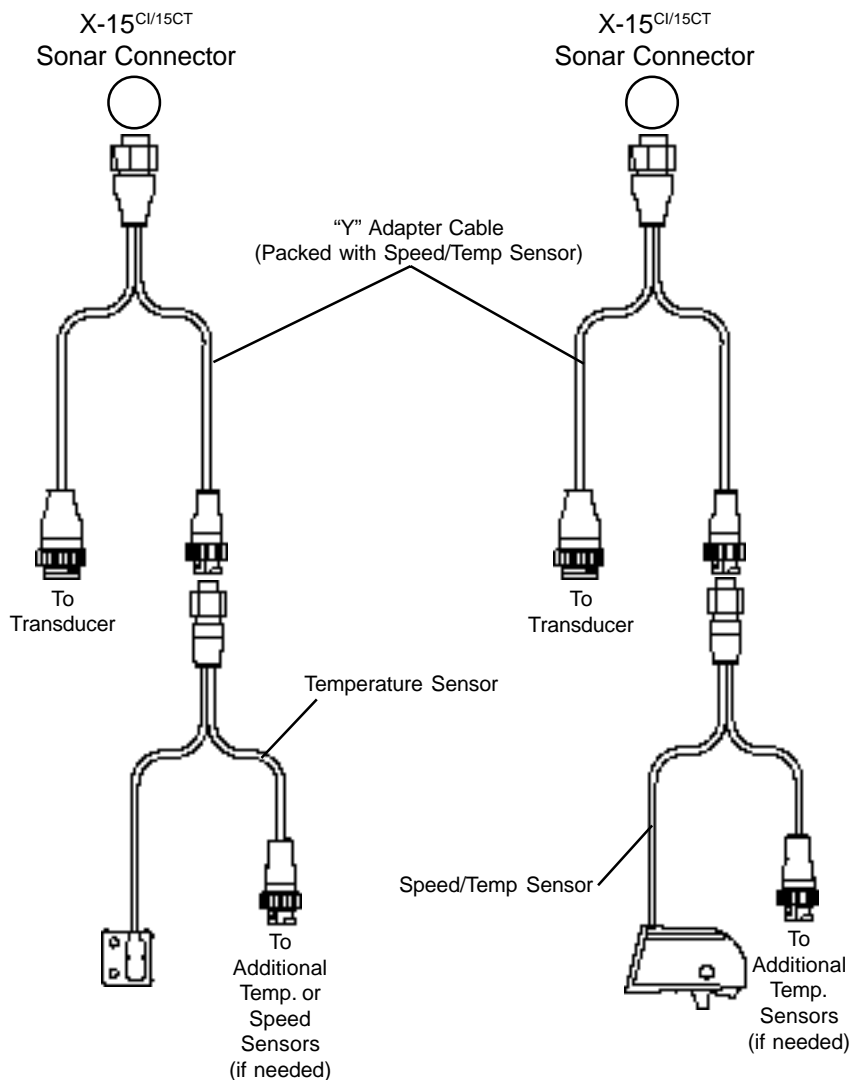

MMC

This unit can use up to two MMC (MultiMediaCard) cartridges. They store the maps, waypoint and route information, sonar data, and more.

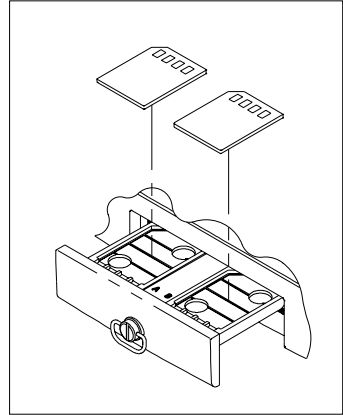
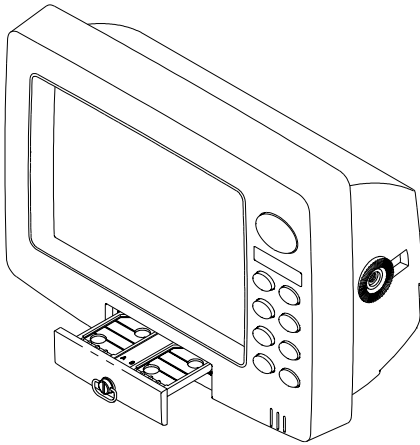

To install a MMC cartridge, twist the drawer retainer counter-clockwise and pull. The drawer will come out of the unit. Place the MMC cartridge FACE DOWN. (see above) Slide the drawer back into the unit and twist the retainer clockwise. The MMC is now ready for use.

For more information on saving and recalling sonar data to the MMC, see page 68.

Map storage requires the MapCreate™ software and a MMC Interface. If your unit did not come with these, they are available for purchase separately.

You can also store plot trails, icons, waypoints, and routes on a MMC. See page 69 for more information.

KEYBOARD

The keyboard has keys arranged in two vertical columns beneath the arrow keys. The menu key near the bottom left corner of the keyboard activates the first menu page. The other keys are used to zoom the display, change modes, and other functions.

ZOUT/ZIN - These keys “zoom” the map or the sonar screen in and out.

PAGES - This key switches the unit between different sonar or GPS modes.

WPT - Saves and recalls waypoints.

MENU - Press this key to show the menus and gain access to most functions.

EXIT - Clears menus and entries.

ENT/ICONS - Used to select entries and accept menu selections. When a menu is not showing, pressing this key activates the ICON menu.

PWR/LIGHT - Turns the unit on and off. When the unit is on, pressing this key turns the backlights on or off.



Note: Pressing the PWR/LIGHT key repeatedly changes the backlight level. There are three levels available.

SONAR OPERATION

PAGES

Turn the unit on by pressing the PWR/LIGHT key. If the sonar screen is not showing, press the PAGES key. A menu similar to the one at right appears. Press the left or right arrow key to highlight the Sonar label. This gives you four selections: Full Sonar Chart, Split Zoom Sonar Chart, Split (Dual) Frequency Sonar Chart, or Digital Data only. Once the desired menu is selected, press the EXIT key to erase the menus.



Full Sonar Chart

This is the default mode used when the unit is turned on for the first time or when it's reset to the factory defaults. The bottom signal scrolls across the screen from right to left. Depth scales on the right side of the screen aid in determining the depth of targets. The line at the top of the screen represents the surface. The bottom depth and surface temperature (if equipped with a temperature sensor) show at the top left corner of the screen. The FasTrak™ display shows just to the right of the scale. This changes all echoes into short horizontal bars, replicating a flasher sonar. The zoom bar on the far right shows the area that's zoomed when the zoom is in use. (See the Zoom section for more information.) The frequency of the transducer in use shows at the bottom of the screen.

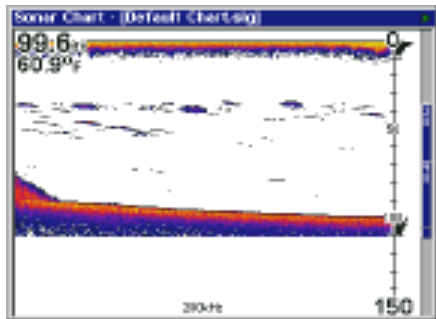

Split Zoom Sonar Chart

A split chart shows the underwater world from the surface to the bottom on the right side of the screen. The left side shows an enlarged version of the right side. The zoom range shows at the bottom left corner of the screen. In this example, the zoom range is 2X, or two times the right side's view.

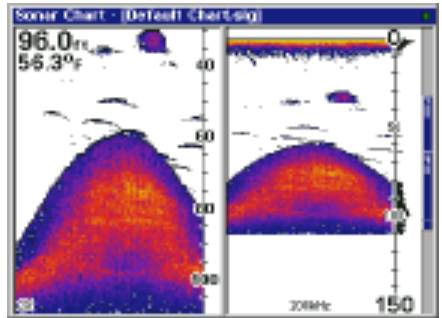

Split Frequency Sonar Chart

This chart shows sonar data from the 50 kHz transducer element (if equipped) on the left side of the screen, and data from the 200 kHz transducer element on the right. All features are the same as the Full Sonar Chart.

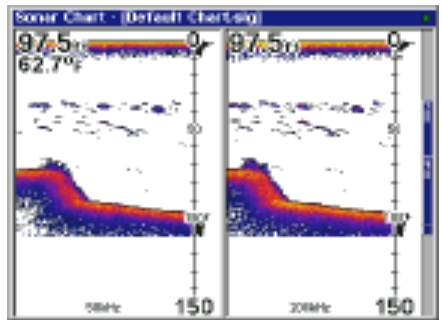

Digital/Chart

This mode shows the chart on the right side of the screen. The left side has seven large digital boxes containing the Water Depth at the top of the screen, (with the shallow and deep alarm settings immediately beneath the depth) Water Speed (from an optional speed sensor), Water Distance (distance travelled or log) also requires a speed sensor. Surface Water Temperature, Temperature #2, Temperature #3, and input voltage. (Note: Temperature #2 and #3 require additional temperature sensors.)

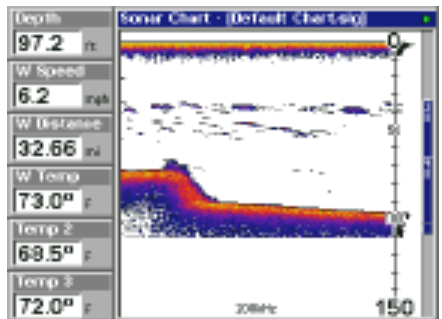

Customizing the Digital/Chart Screen

The Digital/Chart screen can be customized to show different digital data than the defaults shown on the screen at the bottom of page 8. To customize this screen, press the MENU key while the Digital/Chart screen is showing. Scroll down to the bottom of this menu to the Customize label and select it. The Water Speed bar flashes, signifying that the window can be changed. Press the ENT key to show a menu of available options. Choose the data that you want shown at this location, then press the ENT key to select it. To change another, simply press the down arrow key. The ID bar will flash on the selected box. Repeat the above steps until you're finished customizing. Press the EXIT key to stop the bar from flashing.



MENUS

This unit uses menus extensively to guide you through its functions and features. To use the menus, press the MENU key.

(Note: There are two “layers” of menus. Pressing the MENU key once brings up the first set of menus, pressing the menu key again brings up the second set.)

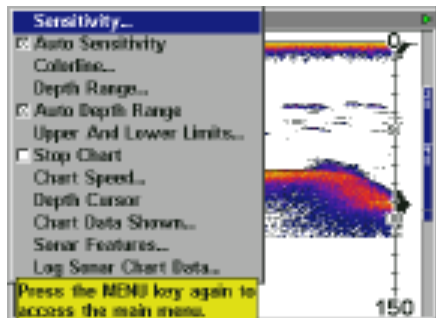

Use the arrow keys to navigate through the menus. Generally, to make a selection from a menu, highlight the desired item with the arrow keys, then press the ENT (enter) key. The EXIT key erases the menus.

Note: There is a mode that splits the screen in half, with the map on the left and the sonar on the right. This screen can be found in the Map/Map With Sonar page. When this screen is activated, you will have to specify which side the menu key corresponds to. To do this, press the PAGES key twice while the Map With Sonar screen is showing. The black bar at the top of the screen will begin flashing above either the map or the sonar. Use the arrow key to select the side that you wish to assign the MENU key to. Press the EXIT key when you're finished. To reassign the menu key, repeat the above steps.

SONAR OPTIONS

Sensitivity

The sensitivity controls the ability of the unit to pick up echoes. A low sensitivity level excludes much of the bottom information, fish signals, and other target information. High sensitivity levels let you see this detail, but it can also clutter the screen with many undesired signals. Typically, the best sensitivity level shows a good solid bottom signal with Grayline and some surface clutter.

The sensitivity is adjusted to keep a solid bottom signal displayed, plus a little more when the unit is in the automatic mode. This gives it the capability to show fish and other detail.

However, situations occur where it becomes necessary to increase or decrease the sensitivity. This typically happens when you wish to see more detail, so an increase in sensitivity is indicated. The procedure to adjust it is the same whether the unit is in the automatic or manual mode.

To adjust the sensitivity, press the MENU key, then select "Sensitivity". The screen at right appears. The sensitivity control has a vertical adjustment bar. The number at the bottom of the bar shows the percentage of sensitivity in use.

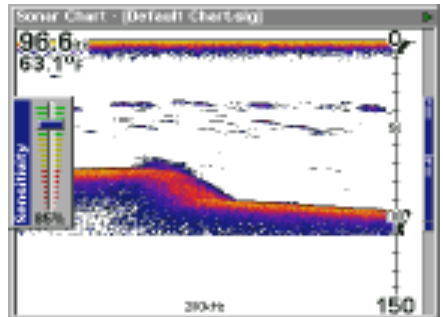

To increase the sensitivity level, press the up arrow key. As you press the key, the control knob will move upward and the percentage will increase in value. You can also see the difference on the chart record as it scrolls. When the sensitivity is at the desired level, release the key.

To decrease the sensitivity level, press the down arrow key. The control knob will move downward and the percentage will decrease. When the sensitivity is at the desired level, release the key. When you reach either the maximum or minimum limit, a tone sounds.

To erase the menu, press the EXIT key.

Automatic Sensitivity

The unit can adjust the sensitivity for you. It bases the sensitivity level on water depth and conditions. To turn this on, press the MENU key, then

select "Auto Sensitivity" and press the ENT key. To turn it off, repeat the above steps. Press the EXIT key to erase the menu.

COLORLINE

Colorline lets you distinguish between strong and weak echoes. It "paints" gray on targets that are stronger than a preset value. This allows you to tell the difference between a hard and soft bottom. For example, a soft, muddy or weedy bottom returns a weaker signal which is shown with a narrow, lighter colored colorline. A hard bottom returns a strong signal which causes a wide gray line.

If you have two signals of equal size, one with color and the other without, then the target with color is the stronger signal. This helps distinguish weeds from trees on the bottom, or fish from structure.

Colorline is adjustable. Since Colorline shows the difference between strong and weak signals, adjusting the sensitivity may require a different Colorline level, also. The level chosen by the unit at power on is usually adequate for most conditions. Experiment with your unit to find the Colorline setting that's best for you.

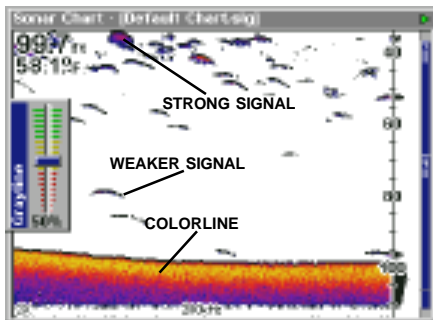

To adjust the Colorline level, press the MENU key, then select "Colorline". The screen above appears. Use the up or down arrow keys to adjust the color level. You can see the change on the chart record as you press the keys. After you've finished, press the EXIT key to erase the menu.

RANGE - Automatic

When turned on for the first time, the bottom signal is automatically placed in the lower half of the screen. This is called Auto Ranging and is part of the automatic function. However, depending upon the bottom depth and the current range, you can change the range to a different depth. To do this, press the MENU key, then select "Depth Range". The screen at right appears. Press the up or down arrow keys to select a different

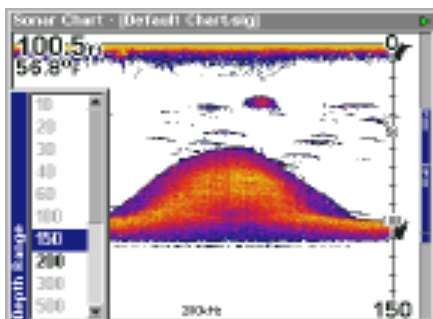

range that's highlighted. The range numbers that are gray cannot be selected. When you're finished, press the EXIT key to erase the menu.

RANGE - Manual

You have complete control over the range when the unit is in the manual mode.

To change the range, first turn the automatic depth range off by pressing the MENU key, then selecting "Auto Depth Range", then press the ENT key to turn it off. Next, select "Depth Range". Press the up or down arrow keys to select a different range. The available ranges are 0-10, 20, 30, 40, 60, 100, 150, 200, 300, 500, 800, 1000, 1500, 2000, and 3000 feet. After selecting the range, press the EXIT key to erase the range menu.

NOTE: The sonar's depth capability depends on the transducer installation, water and bottom conditions, and other factors.

RANGE - Upper and Lower Limits

Virtually any segment of the water can be displayed by using the upper and lower limit feature. This lets you pick the shallow and deep range limits that are shown on the screen, provided there is at least ten feet between the upper and lower limit. For example, a range from 12 feet to 34 feet.

To change the upper and lower limits, press the MENU key, then select "Upper and Lower Limits". A screen similar to the one at right appears. Upper Limit is highlighted. To select it, press the ENT key. To select the lower limit, press the down arrow key to highlight it, then press the ENT key. Once a limit window is selected, the range inside the window changes to zeros. Use the arrow keys to both select and change the numbers in the window. Press the ENT key to accept the change. Press the EXIT key when you're finished. The Upper and Lower Limit menu erases and the unit begins scrolling echoes across the screen using the new range values.

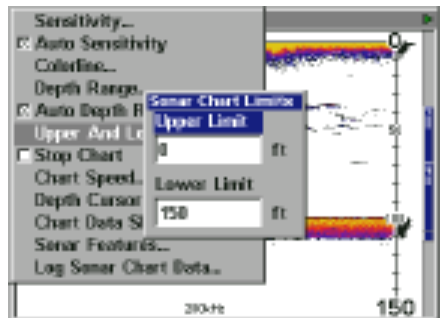

Changing the upper and lower limits gives you far greater control over the range. This feature lets you "zoom" the display in virtually unlimited combinations. Virtually any segment of the water, from the surface to the bot-

tom can be shown, which enlarges targets to best suit your fishing needs and water conditions.

ZOOM

“Zooming” the display is a common method used to enlarge small detail, fish signals, and the bottom with its associated structure. This unit lets you zoom the display quickly and easily by pressing the ZIN key. Pressing it once doubles the size (2X) of all echoes on the screen. Pressing it again quadruples the size of the echoes (4X). The zoom bar on the far right side of the screen shows which echoes will be displayed on the screen when the ZIN key is pressed. For example, pressing the ZIN key once will enable a 2X zoom which will show all echoes that are between the top and bottom of the 2X zoom bar. Pressing the key again will give a 4X zoom and only the echoes between the top and bottom of the 4X bar will show on the screen.

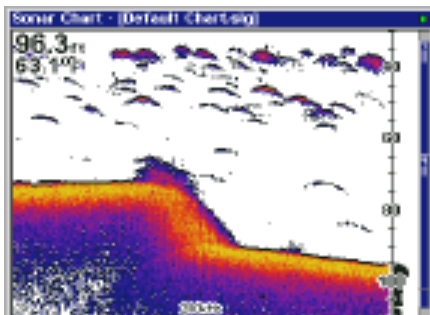

Press the ZOUT key to return the display to the normal mode.

STOP CHART

To temporarily stop the chart from scrolling, press the MENU key, then select “Stop Chart” from the menu and press the ENT key. Repeat these steps to start the chart again.

CHART SPEED

The rate that echoes scroll across the screen is called the chart speed. It's adjustable by pressing the MENU key, then selecting “Chart Speed”. A sliding knob adjustment appears on the screen. The default is maximum. Press the up or down arrow key to adjust the speed, then press the EXIT key to erase the menu.

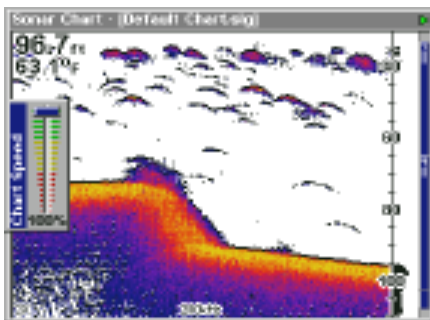

DEPTH CURSOR

The depth cursor consists of a horizontal line with a digital depth box on the right side. The numbers inside the box show the depth of the cursor.

The cursor can be moved to any location on the screen, letting you pinpoint the depth of a target.

To show the depth cursor, press the MENU key, then select "Depth Cursor". Press the ENT key. The cursor appears at the top of the screen. Use the arrow keys to move the cursor to the desired depth.

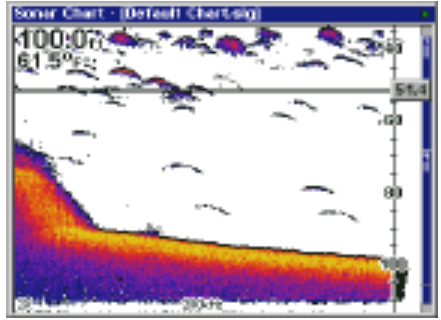

Erase the depth cursor by pressing the EXIT key.

CHART DATA

The digital information shown in the upper left corner of the display along with the zone alarm and zoom bar can be changed using the Chart Data menu. To use this menu, press the MENU key, select "Chart Data Shown" and press the ENT key. A screen similar to the one at right appears.

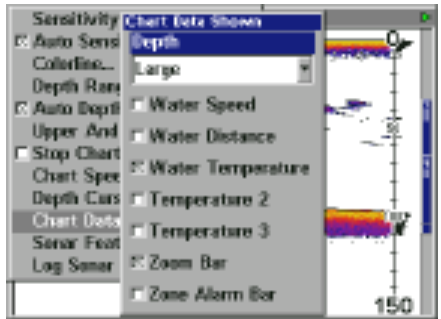

The unit can show the digital depth in large numbers (default), small numbers, or off. To change it, select the "Depth" label, then press the ENT key. Highlight the desired setting using the arrow keys, then press the ENT key.

To change any of the other settings, on this screen, select them using the arrow keys, then press the ENT key to select them. Press the EXIT key to erase the menu when you're finished.

SONAR FEATURES

Several key sonar options are under the "Sonar Features" menu on the main menu. Select the main menu by pressing the MENU key, then select "Sonar Features" and press the ENT key. The menu shown at right appears.

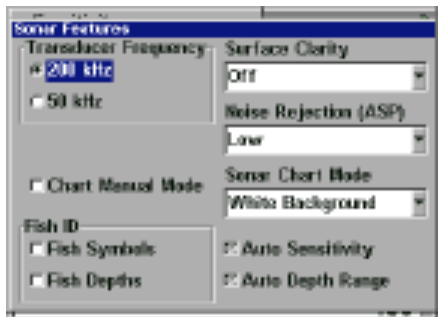

Transducer Frequency

This unit operates from both 200 kHz and 50 kHz. The default frequency is 200 kHz. It's best for use in shallow water. The 50 kHz frequency is best for deep water, especially saltwater. Use the arrow keys to highlight the desired frequency, then press the ENT key to select it.

Surface Clarity

The markings extending downward from the zero line on the chart are called "surface clutter". These markings are caused by wave action, boat wakes, temperature inversion, and more.

The surface clarity control reduces or eliminates surface clutter signals from the display. It does this by changing the sensitivity of the receiver, decreasing it near the surface and gradually increasing it as the depth increases. The maximum depth that the surface clarity control can affect is 75% of the selected depth range. For example, on a 0 - 60 foot range with surface clarity control set to high, surface clutter will be reduced down to 45 feet.

There are three levels of surface clarity available: low, medium, or high. It can also be turned off. The default level is low. To change it, highlight "Surface Clarity" on the "Sonar Features" menu, then press the ENT key to select it. Use the cursor keys to highlight the desired level of surface clarity, then press the ENT key.

Noise Rejection

The automatic noise rejection system built into this unit constantly evaluates the effects of boat speed, water conditions, and interference from electrical and mechanical sources such as bilge pumps, engine ignition systems and wiring, even engine vibration. It then works to reduce or eliminate the negative effects on the sonar screen. This gives the best display possible under most conditions.

The Noise Rejection system is an effective tool in combating noise. In sonar terms, noise is any undesired marks on the display.

This unit has two levels of noise rejection: normal and high. It can also be turned off. The default is normal. To change it, highlight "Noise Rejection" on the "Sonar Features" menu, then press the ENT key to select it. Use the cursor keys to highlight the desired level of noise rejection, then press the ENT key.

SONAR FEATURES (cont.)

Fish Symbols

The Fish Symbols feature identifies targets that meet certain conditions as fish. The microcomputer analyses all echoes and eliminates surface clutter, thermoclines, and other signals that are undesirable. In most instances, remaining targets are fish. The Fish Symbols feature displays symbols on the screen in place of the actual fish echoes.

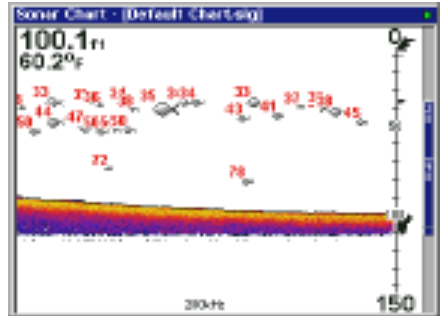

There are several fish symbol sizes. These are used to designate the relative size between targets. In other words, it displays a small fish symbol when it thinks a target is a small fish, a medium fish symbol on a larger target, etc.

The microcomputer is sophisticated, but it can be fooled. It can't distinguish between fish and other suspended objects such as trotlines, turtles, submerged floats, air bubbles, etc. Individual tree limbs extending outwards from a group of limbs is the hardest object for the Fish Symbols feature to distinguish from fish.

You may see Fish Symbols symbols on the screen when actually, there are no fish. Practice with the unit in both the Fish Symbols mode and without to become more familiar with the Fish Symbols feature.

The default for Fish Symbols is off. To turn the Fish Symbols feature on, highlight "Fish Symbols" on the "Sonar Features" menu. Press the ENT key to turn the Fish Symbols feature on. Any targets the microcomputer determines are fish will be displayed as fish symbols.

Fish Depths

The Fish Depths feature shows the depth of a fish symbol when it appears on the display. This lets you accurately gauge the depth of targets. This feature is available only when the Fish Symbols feature is on.

The default for Fish Depths is off. To turn this feature on, highlight "Fish Depths" on the "Sonar Features" menu. Press the ENT key to turn the Fish Depths feature on. (Note: If Fish Symbols is off, turning Fish Depths on will also turn Fish Symbols on.)

LOG SONAR CHART DATA

If you have a MMC installed in the unit, the sonar data shown on the screen can be saved to the MMC. This can be played back using the sonar simulator at any time.

To save the chart data, press the MENU key, then select “Log Sonar Chart Data”. The screen at right appears.



To save data using the defaults on this screen, highlight “Start Logging” and press the ENT key. You can change any of the defaults on this screen, if desired. When finished, press the EXIT key.

DISPLAY SETTINGS

Contrast/Backlight/Display Mode

To adjust these settings, press the MENU key *twice*. This shows the second menu page. Highlight “Screen” at the top of the page and press the ENT key. The screen at right appears.

Contrast is highlighted on this menu by default. To adjust it, press the ENT key and use the left or right arrow keys to change it. Press the ENT key when finished.



To adjust the backlighting’s brightness, first turn it on by pressing the PWR key. Next, highlight the “Backlight” label, then use the arrow keys to adjust it. Press the ENT key when you’re finished.

Display Mode optimizes the LCD (liquid crystal display) for specific viewing conditions. Normally, it should stay in the default mode. However, the High Contrast mode may be useful for shaded light conditions and the Night Viewing mode for use at night. Select the “Display Mode” menu, press the ENT key, then select the desired setting from the drop-down menu. Press the ENT key when you’re finished.

AUDIO

The various sounds that the unit makes can be customized to your own taste. Press the MENU key *twice*, then select “Sounds” from the main menu. The screen at right appears.

The volume control on the right side of the menu adjusts the audio level for all sounds. To change it, select “Volume”, press the ENT key, then adjust it using the arrow keys. Press the ENT key when you’re finished.



The unit sounds a tone when a key is pressed. To turn this off, select “Key Press Sounds” and press the ENT key. The same with “Alarm Sounds”. This silences the tone that’s sounded when an alarm is triggered.

“Alarm Style” lets you select the type of sound that’s played when an alarm is triggered. Select “Alarm Style”, then press the ENT key. Choose the desired setting, then press the ENT key again. The setting is saved and will be played the next time an alarm sounds.

ALARMS

This unit has three different types of sonar alarms. The first is the Fish Alarm. It sounds when the Fish I.D. feature determines an echo or group of echoes is a fish. Another alarm is the Zone Alarm which consists of a bar. Any echo on the chart that appears inside this bar triggers this alarm. The last alarm is called the Depth Alarm. Only the bottom signal will trigger this alarm. This is useful as an anchor watch, a shallow water alert, or for navigation.

To adjust an alarm, first press the MENU key *twice*, then select “Alarms”. Now select “Sonar Alarms”. The screen shown at right appears. Follow the instructions below for setting each alarm.

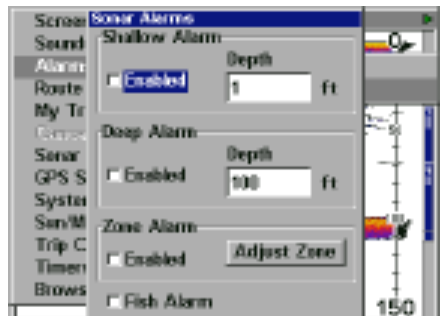

DEPTH ALARMS

The depth alarms sound a tone when the bottom signal goes shallower than the shallow alarm's setting or deeper than the deep alarm's setting. For example, if you set the shallow alarm to ten feet, the alarm will sound a tone if the bottom signal is less than ten feet. It will continue to sound until the bottom goes deeper than 10 feet. The deep alarm works just the opposite. It sounds a warning tone if the bottom depth goes deeper than the alarm's setting. Both depth alarms work only off the digital bottom depth signals. No other targets will trip these alarms. If you turn the digital sonar off, the depth alarms will be inoperative. These alarms can be used at the same time or individually.

To adjust the shallow alarm, highlight the "Depth" label in the Shallow Alarm box. To adjust the deep alarm, highlight the "Depth" label in the Deep Alarm box. Both alarms adjust identically. We'll use the shallow alarm as an example. Highlight the "Depth" label, then press the ENT key. The screen shown at right appears.

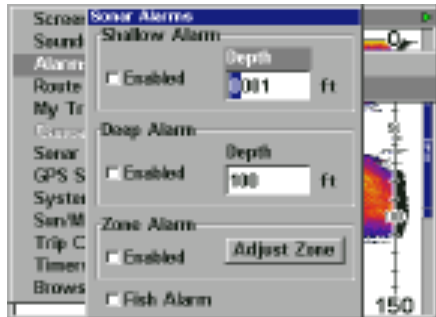

Use the up or down arrow keys to select the number, the right and left keys to move from number to number in the depth. For example, to set the shallow alarm depth to 10 feet, press the right arrow key until the next to last number is highlighted, then press the up arrow key once. The changes the second "0" to a "1". Next, press the right arrow key again and press the down arrow key once. This changes the "1" at the end of the number to a "0". The depth now shows 10 feet.

Press the ENT key to accept this setting. The unit returns to the alarms menu, showing a shallow depth of 10 feet. Now you can activate the alarm by highlighting the "Enabled" label and pressing the ENT key.

With the shallow alarm set at ten feet, anytime the digital depth display goes below ten feet, the shallow alarm sounds.

Set the deep alarm in the same manner. If the digital depth reading goes below the deep alarm setting, the deep alarm will sound.

ZONE ALARM

The zone alarm is triggered when any echo passes inside the zone alarm bar, shown on the right side of the screen. To turn the zone alarm on,

highlight the “Enabled” box in the Zone Alarm box, then press the ENT key. To adjust the zone alarm, highlight the “Adjust Zone” label, then press the ENT key. A screen similar to the one at right appears.

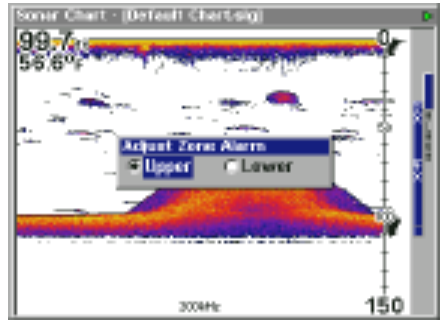

The zone alarm bar shows on the screen to the right of the zoom bar. Any echo - fish, bottom, structure, etc will trigger the zone alarm.

To adjust the top of the zone bar higher or lower, highlight “Upper Limit” and press the ENT key. To adjust the bottom of the bar, highlight “Lower Limit” and press the ENT key.

When the zone alarm is set, press the EXIT key to erase the menus.

FISH ALARM

Use the fish alarm for a distinctive audible alarm when fish or other suspended objects are detected by the Fish I.D. feature. A different tone sounds for each fish symbol size shown on the display. To turn the fish alarm on, select “Fish Alarm” from the sonar alarms menu and press the ENT key. Repeat the above steps to turn the fish alarm off.

SONAR SETUP

The Sonar Setup menu lets you select the transducer type, set the keel offset, calibrate the water speed sensor, reset the trip distance, and turn on the sonar simulator.



To access this menu, press the MENU key *twice*, then select “Sonar Setup”. The screen at right appears.

Transducer Type

This unit can use three different types of transducers: 200 kHz only, 50 kHz only, or 50 kHz and 200 kHz (dual-frequency). The default is 50 kHz and 200 kHz. To change it, select “Transducer Type” from the “Sonar Setup” menu. Highlight the type of transducer installed, then press the ENT key to select it. Press the EXIT key to erase the menu.

Keel Offset

Normally, this unit measures water depth from the face of the transducer. Since the transducer is below the surface of the water, this distance is not the exact water depth. If the transducer is one foot below the surface, and the screen shows the water depth as 30 feet, then the depth is actually 31 feet.

You can calibrate the depth reading using the keel offset feature. First, highlight "Set Keel Offset" on the "Sonar Setup" menu, then press the ENT key. The screen shown at right appears. The current bottom depth shows in the upper left corner of the screen. The keel offset shows in the center of the screen. In this example, we need to change the keel offset

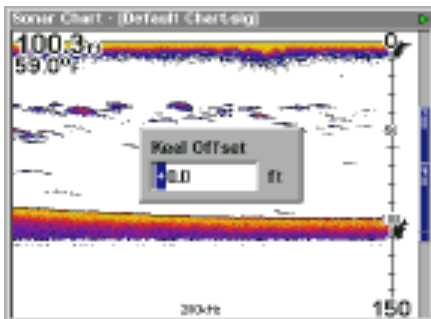

so that the unit will add one foot to the depth, since the transducer is one foot below the surface. Press the right arrow key, then the up or down arrow keys until +1.0 appears in the box, then press the ENT key. This immediately adds one foot to the digital depth display at the top of the screen. The adjustment menu automatically erases when the ENT key is pressed.

Note: Another way to use the keel offset feature is if you want to know the depth of the water below the lowest part of the boat, instead of the surface. To do this, measure the lowest part of the boat below the transducer. In this example, we'll use 3 feet. Now, using the keel offset feature, adjust the offset for a *negative* 3 feet.

Please note that adjusting the keel offset only affects the digital depth display and all features that use the digital depth, such as the depth alarms and FishTrack. This doesn't affect the chart at all.

Calibrate Speed

The speed sensor can be calibrated to compensate for inaccuracies. To do this, select "Calibrate Speed" from the "Sonar Setup" menu. Now calculate the percentage that the speed is off and enter it into the Calibrate Speed window in the center of the screen. When finished, press the EXIT key to erase the window.

Reset Water Distance

The Digital Data page shows distance travelled which is calculated from a

speed sensor input - not the GPS. This distance (called Water Distance) can be reset to zero using the "Reset Water Distance" label on the "Sonar Setup" menu. Simply highlight "Reset Water Distance" and press the ENT key. The menus automatically erase and the water distance display is reset to 0.00.

Sonar Simulator

This unit has a built-in simulator that lets you use it as if you are on the water. All features and functions of the unit are useable. A message appears occasionally that alerts you to the fact that the simulator is on.

To use this, select "Sonar Simulator" from the "Sonar Setup" menu. The screen at right appears.



Turn the simulator on by highlighting "Simulator On" and pressing the ENT key. The simulator immediately begins operation.

If you have a MMC installed, you can select previously saved charts to show instead of the standard one. Select the chart from the "Charts Used" menu. The unit will use the selected chart.

When you are finished with the settings on this screen, press the EXIT key to erase the menus.

SYSTEM SETUP

Many of the unit's basic features can be changed from this menu. Press the MENU key *twice*, then select "System Setup". The screen at right appears.

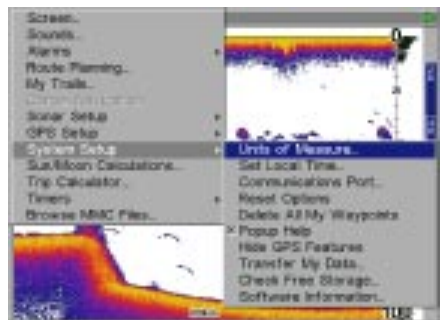

Units of Measure

This menu (shown at the top of the next page) sets the speed and distance (statute or nautical miles, meters), depth (feet, fathoms, or meters), temperature (degrees Fahrenheit or Celsius), and heading (true or magnetic) units.

To change the units, select “Units of Measure” from the “System Setup” menu. Highlight the desired label with the arrow keys, then press the ENT key to change it. Press the EXIT key when you’re finished.



Set Local Time

The GPS requires the local time and date for its initialization and the time and date are saved when a waypoint is saved. To set the time and date, select “Set Local Time and Date” from the System Setup menu. The screen shown at right appears.

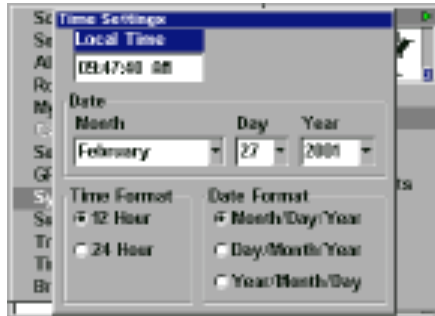

Highlight the field that you wish to change using the arrow keys, then press the ENT key to change it. Once you have each field set the way you want, press the EXIT key to erase the menu.

Communications Ports

This unit has two serial ports. Each can be set to send NMEA data or receive data from a DGPS receiver. The baud rate is adjustable from 1200 to 115200 baud. The default is 9600. To change a setting on this screen, highlight it using the cursor keys, then press the ENT key to change it.



If a DGPS receiver is connect to this unit, highlight the appropriate receiver type: “STARLINK DGPS” or “MAGNAVOX DGPS” and press ENT key to turn it on. (Use Starlink DGPS when using Lowrance DGPS Beacon Receivers.) With the exception of serial communications, typically no other setup needs to be made with these receivers.

If you have any other Magnavox or Starlink compatible DGPS receiver connected to this unit, (including a Lowrance DGPS receiver) you may need to change the settings. To do this, select “Configure DGPS”

Configure DGPS

This unit will recognize Starlink® and Magnavox® automatic DGPS receivers. If you have either one of these receivers, select “Configure DGPS”. The screen at right appears. The status of the DGPS signal appears in the boxes at the top, along with the frequency and bit rate of the selected transmitter. To configure the unit for DGPS, highlight the “Frequency” and press the ENT key. Use the arrow keys to enter the frequency of the station that you intend to use. Press the ENT key when you’re finished. Next, set the bit rate in the same manner. If you’re using a Starlink DGPS receiver, leave the “Starlink Auto Tuning Mode” checked. If not, deselect this box.

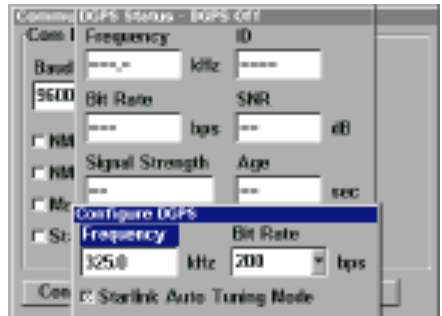

Press the EXIT key when you’re finished with this menu.

Configure NMEA

You can configure the unit to use specific NMEA sentences. Select “Configure NMEA” and press the ENT key. The menu at right appears showing the prefix of the available NMEA sentences. A check mark next to the prefix means that prefix is in use. Select the prefix that you wish to change by highlighting it, then change it by pressing the ENT key. Press the EXIT key when you’re finished with this menu.



Reset Options

To reset all features to their factory defaults, select “Reset Options” from the “System Setup” menu. After selecting, a new menu appears, asking if you want to reset all options. Use the arrow keys to highlight the answer, and the ENT key to select it. The unit clears all menus and returns all settings to the factory defaults.

Note: Reset Options does not erase any waypoints, routes, or plot trails.

Popup Help

Help is available for virtually all of the menu labels on this unit. By highlighting a menu item and leaving it highlighted for a few seconds, a "popup" message appears that describes the function of the menu item.

This feature is on by default. To turn it off, highlight "Popup Help" from the System Setup menu, then press the ENT key. To turn it on again, repeat the above steps.

Hide GPS features

If there is no GPS receiver attached to this unit, then the GPS menus and features can be hidden from view by selecting "Hide GPS Features" on the System Setup menu. The default is on. To turn them on again, select "Show GPS Features" from the System Setup menu.

Software Information

To view the version number of the operating system, select "Software Information" from the System Setup menu. A screen appears with the system information. Press the EXIT key to erase this screen.

SUN/MOON CALCULATOR

This unit has a sunrise/sunset and moonrise/moonset calculator that shows this information anywhere and anytime in the world. To use it, press the MENU key *twice*, then select "Sun/Moon Calculator". The screen shown at right appears. The calculations for both are done at the same time. The sun and moon data for today's date appear above their respective symbols. The moon symbol shows the approximate phase of the moon.



Today's date shows at the top of the screen. If you want to know the sunrise/sunset for a different date, change it by selecting the month, day, or year by pressing the ENT key, then enter the new date with the arrow keys. The unit recalculates the sun and moon data for the date you entered.

The sun and moon data show for your present position. To choose a dif

ferent location, select “Choose Position” and enter the new position. The unit recalculates the sun and moon data for the location that you entered.

Press the EXIT key to erase this screen.

GPS OPERATION

NOTE: A LGC-12S GPS module or an external GPS receiver with NMEA output must be attached to this unit in order to use the position and navigation features.

WARNING!

Use this product only as an aid to navigation. A careful navigator never relies on only one method to obtain position information.

CAUTION

This GPS receiver (like all GPS navigation equipment) will show the shortest, most direct path to a waypoint. It provides navigation data to the waypoint, regardless of obstructions. Therefore, the prudent navigator will not only take advantage of all available navigation tools when travelling to a waypoint, but will also visually check to make certain a clear, safe path to the waypoint is always available.

INTRODUCTION TO GPS

The Global Positioning System (GPS) was developed by the United States Department of Defense as a 24-hour a day, 365 days a year global navigation system for the military. Civilian availability was added (but with less accuracy) using the same satellites. Twenty-four satellites orbit the Earth. Three of these satellites are spares, unused until needed. The rest virtually guarantee that at least four satellites are in view nearly anywhere on Earth at all times.

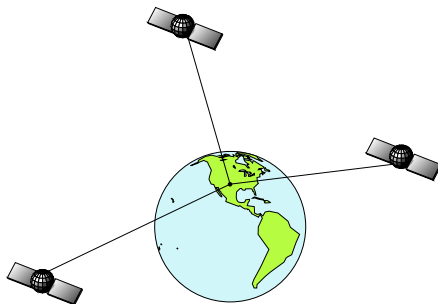

The system requires three satellites in order to determine a position. This is called a 2D fix. It takes four satellites to determine both position and elevation (your height above sea level - also called altitude.) This is called a 3D fix.

Remember, the unit must have a clear view of the satellites in order to receive their signals. Unlike radio or television, GPS works at very high frequencies. The signals can be blocked easily by trees, covered docks, even your body.

Never use this GPS receiver while operating a vehicle!

Like most GPS receivers, this unit doesn't have a compass or any other navigation aid built inside. It relies solely on the signals from the satellites to calculate a position. Speed, direction of travel, and distance are all calculated from position information. Therefore, in order for it to determine direction of travel, you must be moving and the faster, the better. This is not to say that it won't work at trolling speeds - it will. There will simply be more "wandering" of the data shown on the display.

If you want better performance, many manufacturers (including Lowrance) sell a DGPS receiver that attaches to your GPS receiver. The DGPS system transmits correction signals that increase the accuracy to about 10 meters. The DGPS receiver takes signals from these land-based transmitters and gives them to the GPS receiver which then uses them to show a more accurate position. (You can use the signals from all of the Coast Guard DGPS stations for free, by the way.) The downside to this is it requires another piece of electronic gear (the DGPS receiver). And you have to be close enough to a station to receive the DGPS signals.

Generally, you find that using your GPS receiver without DGPS is both easy and amazingly accurate. It's easily the most accurate method of electronic navigation available to the general public today. Remember, however, that this receiver is only a tool. Always have another method of navigation available, such as a chart and a compass.

Also remember that this unit will always show navigation information in the shortest line from your present position to a waypoint, regardless of terrain! It only calculates position, it can't know what's between you and your camp, for example. It's up to you to safely navigate around obstacles, no matter how you're using this product.

FINDING YOUR POSITION

Auto Search

To lock onto the satellites, the GPS receiver needs to know its current position, UTC time, and date. (Elevation (altitude) is also used in the equation, but it's rarely required to determine a position.) It needs this data so that it can calculate which satellites should be in view. It then searches for only those satellites. When your GPS receiver is turned on for the first time, it doesn't know what your position or elevation (altitude) is. It does know the current UTC time and date since these were programmed into it at the factory and an internal clock keeps the time while the unit is turned off. (If the time and/or date are incorrect, you can set it using the "Set Local Time" menu. See page 23 for more information.) It begins searching for the satellites using the above data that it acquired the last time it was turned on. This probably was at the factory. Since it's almost certain that you're not at our factory, it's probably looking for the wrong satellites. If it doesn't find the satellites it's looking for after five minutes, it switches to Auto Search. The receiver looks for any satellite in the sky. Due to advanced technology, the auto search time has shrunk to about five minutes, so the longest time you should ever have to wait is ten minutes from the time you turn the unit on until it locks onto the satellites and shows a position. Once the unit locks onto the satellites, it should take less than a minute to find your position the next time it's turned on, provided you haven't moved more than approximately 100 miles from the last location it was used.

The Auto Search function can be started at any time. Press the MENU key *twice*, then select "GPS Auto Search". A new menu appears, "Perform GPS Auto-Search". Highlight "Yes" and press the ENT key. The menus disappear and the unit will begin the auto search.



Manual Initialization

If you don't want to wait for the Auto Search, then you may be able to speed up the initialization process by using the manual initialization feature. Using this feature tells the unit its approximate position. Once it knows its location, it determines exactly which satellites should be in view and starts looking only for those satellites.

To manually initialize the unit, press the PAGES key. Using the arrow keys, select "Status". Press the EXIT key to erase the menu. The screen at

right appears. Now press the MENU key. Select "INITIALIZE GPS". A screen similar to the one below right appears. Use the arrow keys to move the crosshairs to your approximate location on the map. You can use the ZIN and ZOUT keys to enlarge the map which makes it easier and faster to find your location. The box at the bottom of the screen shows the latitude and longitude of the cursor position. A box pops up on the screen, showing the name of the nearest highway (if a MMC with a map is installed) along with the distance and bearing from the last known position. Once you have the crosshairs on your location, press the ENT key. The unit returns to the satellite status screen.

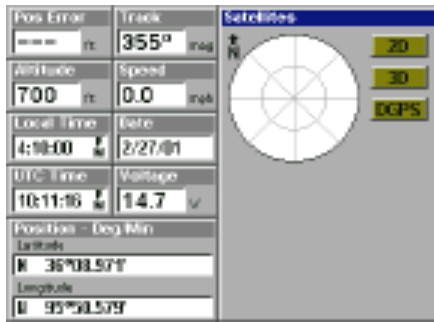

Using this manual initialization method loads a position that's close to yours into the GPS receiver. It should now have position, time, and date, thereby giving it the data it needs to determine which satellites are in view. Once the satellites are known, the receiver searches for only those satellites, making a lock faster than an auto search method.

All position and navigation data flashes until the unit acquires a position. Do not rely on any data that is flashing! When the numbers are flashing, they represent the last known values when the unit lost its lock on the satellites.

Position Acquisition

When the receiver locks onto the satellites and calculates a position, it shows the message "Position Acquired" on the screen. Once the unit has acquired the satellites and the position acquired message appears, it's ready for use.

(Note: The altitude data may still flash even if the unit shows a "Position Acquired" message and all other data is not flashing. The unit must be locked onto at least four satellites to determine altitude. It only takes three satellites to determine position. You can navigate with this unit if the alti

tude is flashing, simply ignore the altitude display until it quits flashing.)

REMEMBER, DO NOT NAVIGATE WITH THIS UNIT UNTIL THE NUMBERS STOP FLASHING!

Require DGPS

Normally, the unit will flash the position and navigation data when it loses the satellite fix, but it does not flash the data when it loses the DGPS fix. If you want the unit to flash the position and navigation data when it loses the DGPS data, select the Status screen, highlight "Require DGPS" and press the ENT key. Press the EXIT key to erase the menu.

GPS OPERATION

PAGES

Turn the unit on by pressing the PWR/LIGHT key. If a GPS screen is not showing, press the PAGES key. A menu similar to the one at right appears. Press the left or right arrow key to highlight the Status, Navigation, or Map label. The Map menu gives you five selections: Full Map, Digital Data, Two Position Formats, Two Maps, or Map with Sonar (split-screen map and sonar). Once the desired menu is selected, press the EXIT key to erase the menus.



Status

This screen shows a graphical view of the satellites that are in view. Each satellite is shown on the circular chart relative to your position. The point in the center of the chart is directly overhead. The small inner ring represents 45° above the horizon and the large ring represents the horizon. North is at the top of the screen. You can use this to see which satellites are obstructed by obstacles in your immediate area if you hold the unit facing north.

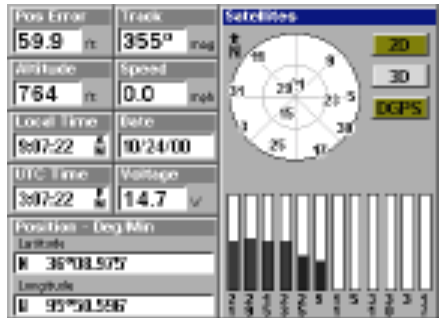

The GPS receiver is tracking satellites that are in bold type. The receiver hasn't locked onto a satellite if the number is grayed out, therefore it isn't being used to solve the position.

Beneath the circular graph are the bar graphs, one for each satellite in view. Since the unit has twelve channels, it can dedicate one channel per visible satellite. The taller the bar on the graph, the better the unit is receiving the signals from the satellite.

The "Position Error" (horizontal position error) shown in the upper left corner of the screen is the expected error from a benchmark location. In other words, if the position error shows 50 feet, then the position shown by the unit is estimated to be within 50 feet of the actual location. This also gives you an indicator of the fix quality the unit currently has. The smaller the position error number, the better (and more accurate) the fix is. If the position error flashes, then the unit hasn't locked onto the satellites, and the number shown isn't valid.

Customizing the Status Screen

Many of the digital displays can be customized to show different digital data than the defaults. To customize this screen, press the MENU key while the Status screen is showing. Scroll down to the bottom of this menu to the Customize label and select it. The Position Error bar flashes, signifying that the window can be changed. Press the MENU key to show a menu of available options. Choose the data that you want shown at this location, then press the ENT key to select it. To change another, simply press the down arrow key. The ID bar will flash on the selected box. Repeat the above steps until you're finished customizing. Press the EXIT key to stop the bar from flashing.

Navigation

This screen has a compass rose that not only shows your direction of travel, but also the direction to a recalled waypoint. The navigation screen looks like the one at right when you're not navigating to a waypoint. Your position is shown by an arrow in the center of the screen. Your trail history, or path you've taken is depicted by the line extending from the arrow. The large arrow pointing down at the top of the compass rose indicates the current track (direction of travel) you are taking.



When navigating to a waypoint, the Navigation screen looks like the one at right. Your ground speed, track, distance and bearing to waypoint, and course are all shown digitally on this screen. Closing speed is also known as velocity made good. It's the speed that you're making towards the waypoint. The current cross track error is shown in the Off Course box. This is the distance you are off-course to the side of the desired course line. The course line is an imaginary line drawn from your position when you started navigating to the destination waypoint. It's shown on the steering screen as a vertical dotted line. Lines on either side of the present position show the current cross track error range. The default for the cross track error range is 0.20 mile. For example, if the present position symbol touches the right cross track error line, then you are .20 mile to the right of the desired course. You need to steer left to return to the desired course. You can use the ZIN or ZOUT keys to change the cross track error range. A circle depicting your destination (waypoint) appears on the screen as you approach the waypoint as shown on the screen at right.

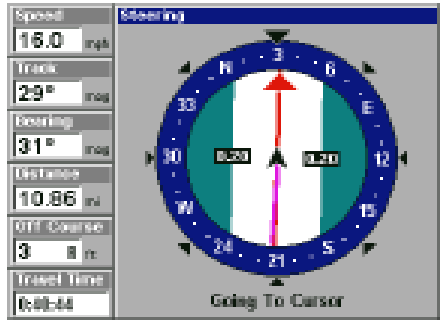

Travel Time is the time that it will take to reach your destination at your present closing speed. Arrival Time is the local time that it will be when you arrive at the destination, based upon your present closing speed and track.

Customizing the Navigation Screen

Many of the digital displays can be customized to show different digital data than the defaults shown above. This is done exactly like the customization of the Status screen. See page 31 for instructions to customize this screen.

Map

There are five different mapping screens: Full Map, Digital Data, Two Position Formats, Two Maps, and Map with Sonar.



(Note: Maps must be downloaded from a MapCreate™ CD-ROM onto a MMC. The MMC must be installed into the unit before maps will show on the screen. If your unit came with a MMC, MMC Interface, and CD-ROM, then follow the instructions in the separate booklet. If these items were not included with your unit, then you will need to purchase the accessory pack that includes these items.)

The maps on the CD have the majority of their detail in far southern Canada, the continental United States and Hawaiian islands, northern Mexico, the Bahamas, and Bermuda.

The map screens show your course and track from a “bird’s-eye” view. If you’re navigating to a waypoint, the map shows your starting location, present position, course line, and destination. You don’t have to navigate to a waypoint, however, to use the map.

Using the map is as simple as pressing the PAGES key, then “Full Map”. A screen similar to the one at right appears. The arrow flashing in the center of the screen is your present position. It points in the direction you’re travelling. The solid line extending from the arrow is your plot trail, or path you’ve taken. The plotter’s range shows in the lower right corner of the screen. In this example, the plotter’s range is 4,000 miles from the left edge of the map to the right.



To view the other map screens, press the PAGES key, highlight the MAP label, and press the down arrow key until the desired map screen appears. Press the EXIT key to erase the menu. The “Digital Data” screen has navigation data added to the left side, with the map on the right. The data includes ground speed, closing speed, distance to waypoint, distance off course (cross-track), track, bearing, course, and travel time.



“Two Position Formats” is similar to “Digital Data”, except it adds two present position boxes, one showing latitude/longitude and the other shows the present position in UTM.



“Two Maps” shows two maps side-by-side. You can customized each map with different settings. For example, the map on the left can have a zoom range of .5 miles, while the one on the right has a range of 10 miles. This lets you zoom-in on one side, while seeing a much larger area on the other. Press the PAGES key, then an arrow key to select the right or left map.



“Map With Sonar” shows the map on the left side of the screen and the sonar on the right.

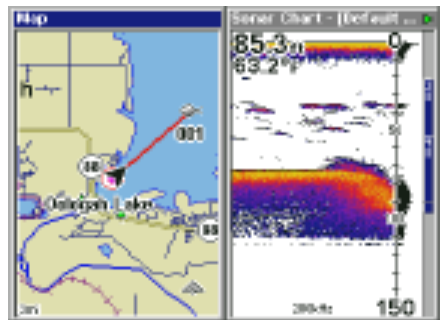

The Z-IN and Z-OUT keys zoom-in and out all maps to enlarge or reduce their coverage area. The available ranges are: 0.1, 0.15, 0.2, 0.3, 0.4, 0.6, 0.8, 1, 1.5, 2, 3, 4, 5, 6, 8, 10, 15, 20, 30, 40, 60, 80, 100, 150, 200, 300, 400, 600, 800, 1000, 1500, 2000, 3000, and 4000 miles.

Cursor

Pressing an arrow key turns on two dotted lines that intersect at the present position symbol. These lines are called a “cursor” and have a variety of uses.

To turn the cursor on, simply press the arrow key in the direction you want the cursor to move. This lets you view areas on the plotter that are away from your present position. The zoom-in and zoom-out keys work from the cursor's position when it's active - not the present position. You can zoom in on any detail, anywhere. The cursor can also place icons and waypoints.



Cursor Distance

You can use the cursor to find the distance between two points. While the cursor is showing, press the MENU key, then select "FIND DISTANCE". The unit returns to the mapping screen. Now move the cursor to the first location that you want to measure the distance from and press the ENT key. Next, move the cursor to the position that you want to measure the distance to.



A line is drawn from the point when the ENT key was pressed to the cursor's present location. The distance and bearing to the second location show in a box next to the cursor's crosshairs. To measure another two points, simply move the cursor and press the ENT key.

Press the EXIT key to erase the cursor. The unit centers your present position on the screen after erasing the cursor.

Map Orientation

By default, this receiver shows the map with north always at the top of the screen. This is the way most maps and charts are printed on paper. This is fine if you're always travelling due north. What you see to your left corresponds to the left side of the map, to your right is shown on the right side of the map, and so on. However, if you travel any other direction, the map doesn't line up with your view of the world.

To correct this problem, a track-up mode rotates the map as you turn. Thus, what you see on the left side of the screen should always be to your left, and so on. A course-up mode keeps the map at the same orientation

as the initial bearing to the waypoint. A “N” shows to help you see which direction is north when either the track-up or course-up mode is on.

In the north-up view shown at right, we’re travelling southeast. In this view, the present position indicator appears to move towards the lower right side of the screen.



NORTH-UP

In the track-up view, the present position moves straight towards the top of the display. Remember, in the track-up mode, the screen rotates as you change direction. It always keeps your direction of travel (track) heading towards the top of the screen.

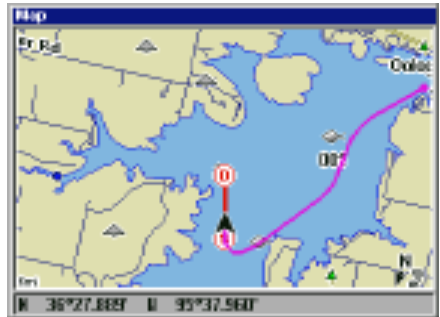

TRACK-UP

In the course-up mode, the screen is locked into your original bearing to the recalled waypoint, regardless of your track.

To select the desired mode, first press the MENU key, then select “Map Orientation”, then select the desired mode. Press the EXIT key to erase this menu.

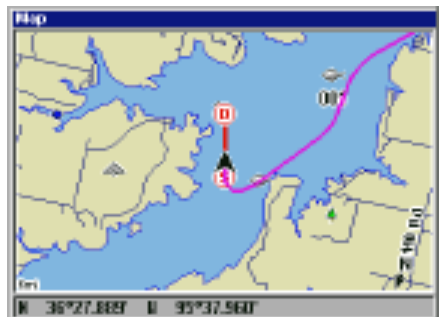

COURSE-UP

Auto Zoom

This receiver has an autozoom feature that eliminates much of the button pushing that competitive units force you to make. It works in conjunction with the navigation features. First, recall a waypoint. (See the waypoint section for more information on navigating to a waypoint.) Then, with the autozoom mode on, the unit zooms out until the entire course shows, from the present position to the destination waypoint (recalled waypoint). As you travel towards the destination, the unit automatically begins zooming in, one zoom range at a time, keeping the destination on the screen.

To turn this feature on, press the MENU key, then highlight "Auto Zoom" using the arrow keys. Press the ENT key to activate it. Press the EXIT key to erase the menus. Repeat these steps to turn it off.

Range Rings/Grid Lines

The map screen can be customized with rings that are 1/2 of the range and/or grids that divide the plotter into equal segments of latitude and longitude. To do this, press the MENU key, then highlight the desired option, then press the ENT arrow key to turn it on. Press the EXIT key to erase the menus. The screen at right shows grids.



Map Data

This menu lets you turn the map off, if desired, which turns the map screen into a plotter; draw the map boundaries or boxes around the areas of detail, or use Navionics maps. If Navionics maps are downloaded to the MMC cartridge, you must have this box selected in order to use the Navionics map.

To make a change on this menu, press the MENU key, then highlight the desired option, then press the ENT arrow key to turn it on. Press the EXIT key to erase the menus.



Map Categories Drawn

This menu determines which of the mapping features are shown on the screen. This includes, waypoints, trails, icons, cities, highways, etc. You can selectively turn on or off any of these items, customizing the map to your needs.

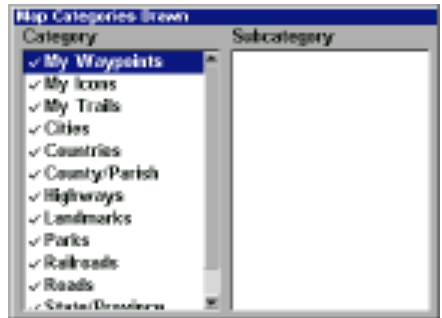

To change the map detail shown, press the MENU key, then select

“Map Catagories Drawn”. The screen at right appears. Use the arrow keys to highlight the desired feature, then press the ENT key to turn it on or off. When you’re finished, press the EXIT key to erase the menus.

ICONS

The map has 42 symbols or “icons” available that can be placed anywhere on the screen. They can be used to mark fishing or hunting locations, landmarks, boat ramps, and virtually any point of interest. An icon can be placed at your present position or at the cursor’s location.

To place an icon at your present position, simply press the ENT key while a mapping screen is on. The screen shown at right appears. Use the arrow keys to highlight the desired icon. Now press the ENT key again. The mapping screen reappears with the icon showing at the position you were at when the ENT key was pressed. On the screens shown below, the shipwreck icon was placed.



To place an icon at the cursor’s position, first use the arrow keys to move the cursor to the location that you wish to place the icon. Next, press the ENT key. Now highlight an icon using the arrow keys. While it’s highlighted, press the ENT key. The map re-



appears with the icon placed at the cursor crosshairs. Press the EXIT key to erase the cursor.

Icons can be erased from the plotter individually, all of a specific type, or all at once. To make changes to the icons, press the MENU key, then select "Delete My Icons". The screen shown at right appears.

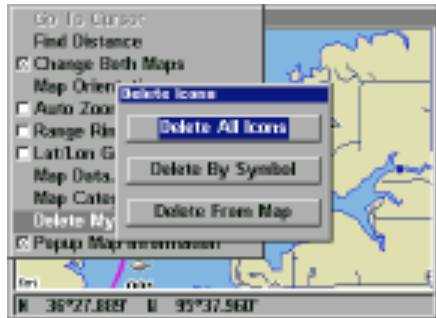

The "Delete All Icons" selection erases all of the icons from memory. Use this only if you want to erase all icons that have been placed on all map screens.

To erase only a certain type of icon, select the "Delete By Symbol" menu. The icon menu appears. Highlight the icon style that you want to erase from memory, then press the ENT key. The unit returns to the map screen with all of the selected icons erased.

You can delete individual icons by selecting "Delete From Map". Once this menu is selected, the unit returns to the mapping screen with the cursor activated as shown at right. Use the arrow keys to move the cursor to the icon that you want to erase. Once the crosshairs are on top of the icon, press the ENT key. The icon is immediately erased. Press the EXIT key to erase the cursor.

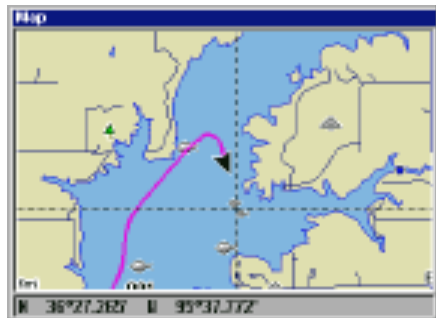

PLOT TRAIL

The line extending from the present position symbol is called a plot trail. (See the example at right.) You can save trails and navigate an existing trail by selecting the "My Trails" menu. Press the MENU key *twice*, then select "My Trails". The screen at the top of the next page appears.



The list of saved trails shows on this screen. The check mark next to the trail's name means that this trail is displayed on the map. An arrow on the right side of the screen points to the trail that's currently in use, next to the number of points in the trail.

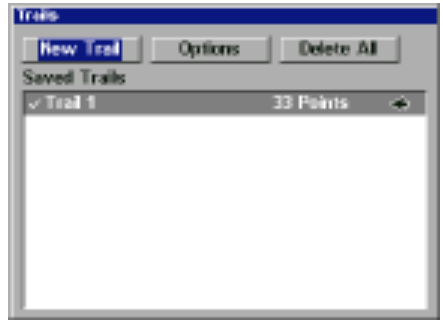

There can be up to 10 plot trails saved with up to 10,000 points per trail.

Edit Trail

To change the settings for an existing trail, highlight the "Saved Trails" menu and press the ENT key. Next, highlight the trail that you wish to change from the list, and press the ENT key. The "Edit Trail" menu appears.



From this menu, the trail's name and number of points used can be changed by selecting them with the arrow keys and the ENT key. If the "Active" box is selected, then the points are updated on this trail. If "Visible" is selected, then the trail shows on the map. Select "Delete Trail" to erase the trail and its settings.

Navigate a Trail

You can follow a saved trail by using the "Navigate" feature on the "Edit Trail" menu (shown above). Selecting the Navigate button brings up the screen at right.



The unit "drops" a point on the trail as you travel. You can navigate from one end of the trail to the other. The points on the trail selected in the box at the top of the screen are shown in the list. The default data for each point in the plot trail is distance and bearing from your present position to each point on the trail.

You can change this to the distance and bearing from one point to the next (leg), travel time to each point, or arrival time for each point. To change this data, select “Display Data”, then press the ENT key. Select the desired data from the list and press the EXIT key.

If you select the “Navigate” button, the unit will return to the mapping screen showing navigation data to the first point on the list. Selecting “Reverse” before navigating inverts the list of points so that the last point on the list is the first one that will be navigated to.

For example, we ran a course on a local lake, (shown at right) from the boat ramp towards a small cove. To navigate back to the boat ramp using the plot trail, press the Menu key twice, select “My Trails” then select the desired plot trail and click on the “Navigate” button. The screen shown at the bottom of the previous page appears. Point 1 on the list is the boat ramp. Click on the “Reverse” button to reverse the plot trail as shown at right. Now the last point on the plot trail (#11) will be the first one that the unit navigates to. Now select the “Navigate” button. The unit returns to the map screen as shown at the bottom of this page.



As you travel, the unit will show navigation data to each point on the plot trail. When you cross the arrival alarm radius (default is 0.1 mile), the arrival alarm sounds an alert. Pressing the Exit key clears the arrival alarm for that point. The unit will continue to show navigation data to each point on the trail until you reach the destination.



Trail Options

This menu lets you change the way the trail updates occur. The options are automatic, time, or distance. When it's in the automatic mode, the unit doesn't update the plot trail while you're travelling in a straight line. Once you deviate from a straight line, the unit "drops" a plot point onto the trail. This conserves plot trail points. If a plot trail uses all of the available points allotted to it, the beginning points are taken away and placed at the end of the trail.

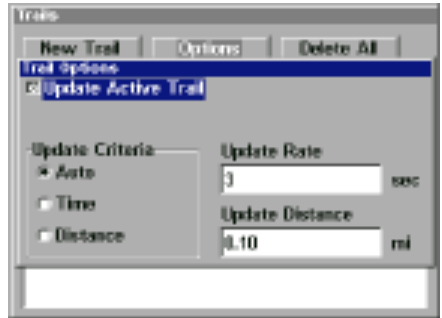

New Trail

To create or delete a trail select "New Trail". The screen at right appears. The name, maximum number of points in the trail, activity, and visibility are all changed on this screen. Simply highlight the section you wish to change using the arrow keys, then select (or change) it by pressing the ENT key. Press the EXIT key to erase this menu.

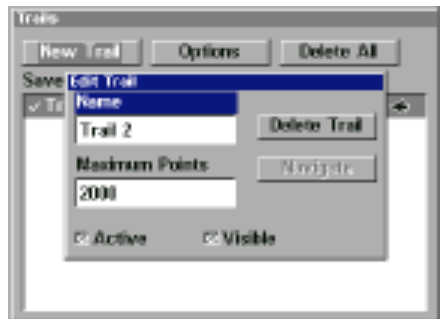

Delete All Trails

To remove all of the trails from memory, select "Delete All" from the "Trails" menu. A menu appears asking if you wish to delete all trails. Select "Yes" if you wish to delete all of the trails. The unit will delete all trails and return to the "Trails" menu.

WAYPOINTS

This GPS receiver gives you the ability to create your own database of locations, called "waypoints". You can save your present position, cursor position, or enter a coordinate and save it as a waypoint. For example, you may wish to store the location of your boat dock as a waypoint before starting on a trip. When you want to return, all you have to do is recall the waypoint and the unit will show distance and bearing from your present position to the dock. This unit stores up to 1000 waypoints.

Saving Your Present Position as a Waypoint (Quick Save Method)

To save your present position, simply press the WPT key twice. Your current position is placed into the first available waypoint number on the list. A message appears on the display telling you the waypoint number it just used. This also momentarily places you in the waypoint menu. Anytime this menu is showing, simply press the WPT key once and the unit will store your present position on the waypoint list.

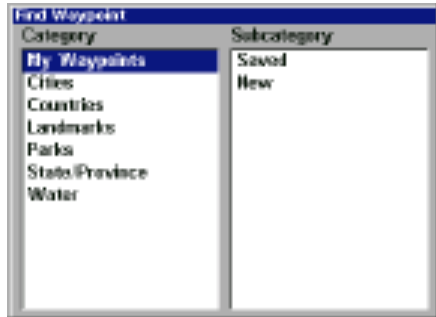

Saving the Cursor Position as a Waypoint

When the cursor is showing on the map and you press the WPT key twice, the cursor's position is placed into the first available waypoint number. In the example screen shown at right, the cursor was placed at the desired location. Pressing the WPT twice causes waypoint number 2 to be placed at the cursor's crosshairs. (Waypoint 2 was the next available waypoint number.) A message appears on the display telling you the waypoint number it just used. Wait a few seconds and the menu will clear automatically. Press the EXIT key to erase the cursor.

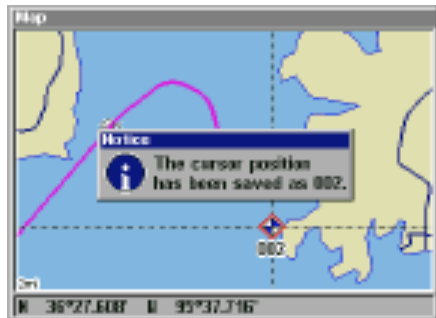

Saving a New Position

To save a position other than the cursor's or the present position as a waypoint, first press the WPT key. The "Find Waypoint" menu appears. "My Waypoints" is highlighted. Press the right arrow key to move to the Subcategory section. Now highlight "New" and press the ENT key. The screen at right appears.

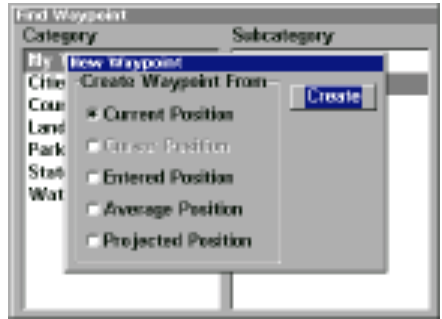

A waypoint can be created from your current position, the cursor position (if activated), a position that you enter, a position averaged over time, and a projected position, using only distance and bearing from your present position.

Current Position and Entered Position - Edit Waypoint

Selecting "Current Position" or "Entered Position" brings up the "Edit Waypoint" menu as shown at right. Choosing this option lets you change the defaults used when the quick-save method is used. You can name the waypoint, choose a symbol to mark the waypoint on the map, and use your current position shown in the latitude/longitude boxes or change it to a different one.

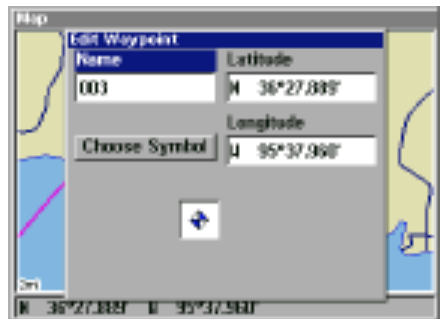

Use the cursor keys to highlight the section that you wish to change and press the ENT key to select it. When all the data is correct on this menu, press the EXIT key. This saves the waypoint and opens the "Waypoint Information" screen as shown at right. This shows the waypoint that you just saved. If all you wanted was to save the waypoint, press the EXIT key to erase the menu. See below for more information on the Waypoint Information menu.



Average Position

This feature averages your position. This helps to eliminate errors in the position due to atmospheric effects and other conditions. When the "Average Position" menu item is selected, a screen similar to the one at right appears. The small plotter screen shows your present position. The number of positions used to calculate the average position shows on the right side of the screen, beneath your present position. When you are ready to save the position, press the ENT key. This brings up the "Edit Waypoint" menu, as shown at the bottom of the page 42. You can name the waypoint, choose a symbol to mark the waypoint on the map, and use your current position shown in the latitude/longitude boxes or change it to a different one.

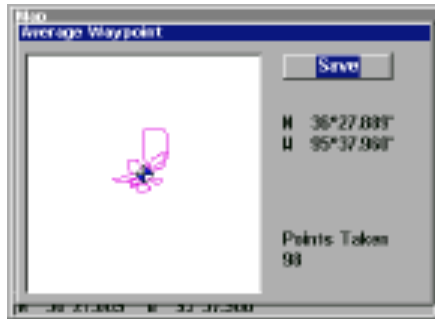

Use the cursor keys to highlight the section that you wish to change and press the ENT key to select it. When all the data is correct on this menu, press the EXIT key. This saves the waypoint and opens the "Waypoint Information" screen as shown at the top of this page. This shows the waypoint that you just saved. If all you wanted was to save the waypoint, press the EXIT key to erase the menu. See the next page for more information on the Waypoint Information menu.

Waypoint Information

This screen shows the currently selected waypoint and its name, latitude/longitude, the local time and date that it was saved, and the distance and bearing from your present position to the waypoint.



To navigate to a waypoint, select "Go To Waypoint". The unit will instantly show navigation data to the selected waypoint.

"Find On Map" returns the unit to a map display with the selected waypoint and the cursor centered on the map. Pressing the EXIT key returns the unit to the Waypoint Information menu.

“Edit Waypoint” returns the unit to the “Edit Waypoint” menu described on page 46. “Delete Waypoint” removes the waypoint from the list.

WAYPOINT NAVIGATION

This unit makes it easy to navigate to any waypoint. All you have to do is press the WPT key, select the waypoint, then select “Go To Waypoint” on the Waypoint Information menu. The unit immediately shows navigation information to the waypoint on all navigation and mapping screens.

In this example, the waypoint named “Big Fish” was recalled. Switching to the MAP-1 screen (shown at right) shows the starting location “S”, the recalled waypoint “Big Fish”, the plot trail from the starting location to the present position, and the present position. The present position arrow also shows the direction of travel (track).



Navigating to a Cursor Position

This unit lets you navigate to a location without storing it in the waypoint database by using the map and cursor. To do this, first switch to a map. Now move the cursor to the location that you want to navigate to. Next, press the MENU key. A new, highlighted menu appears on the list: “Go To Cursor”. Press the ENT key. The unit returns to the map and shows navigation data to the cursor location (shown as “D” on the map).



Navigating to a Waypoint using the Map

The unique “birds-eye” view used by the map gives you an easy way to navigate to a waypoint. On the map screen shown at right, the arrow is your present position.



The box with the “S” in it was your starting location when the waypoint was recalled. The dotted line is called a course line and is the shortest path from the starting location to the destination. The “D” is the cursor destination, when the cursor position is used as a destination. If you follow the course line, you’ll reach the destination, covering the shortest distance in the least time.

CAUTION!

This product does NOT take land features or any other feature into account when it projects the course line on the screen. Use caution when navigating to a location. Make certain there are no obstructions in your path.

MAN OVERBOARD

One of boating’s most terrifying events is having a friend or family member fall overboard. This situation can be deadly on any body of water - fresh or salt. It’s particularly dangerous at night or if you’re out of sight of land. Of course, the first thing to do is remain calm and try all standard safety measures to try and rescue the person.

This unit has a man overboard feature that shows navigation data to the location you were in when the feature was activated. To activate it, press the ZOUT and ZIN keys at the same time. Your position at the time these keys are pressed is used as the man overboard position. A screen similar to the one at right appears.



The steering screen shows a graphical view of your position (shown by the black arrow in the center of the compass rose) and the position of the man overboard (shown by the small circle).

The man overboard position is also stored in the waypoint table for future reference. It can be edited the same as any waypoint. This prevents the inadvertent loss of the current Man Overboard position.



The Man Overboard symbol is also placed on the map screen in the appropriate location. You can use the map screen to navigate to the Man Overboard location, if you so desire.

To stop the unit from showing navigation to the man overboard position, see the Cancel Navigation section below.



Remember, saving the victim is the primary goal. Try all options to rescue the person immediately after the accident happens. Training and education are also good accident preventatives. The Coast Guard has excellent safety courses. Instruct all members on board your boat on safety procedures before leaving the dock. Make certain all on board know what to do before an emergency occurs.

CANCEL NAVIGATION

This unit continues to navigate to a recalled waypoint, the last waypoint in a route, a man overboard position, or the cursor position until you stop it.

To stop the navigation function, press the MENU key *twice*, then select "Cancel Navigation". The unit stops showing navigation information.

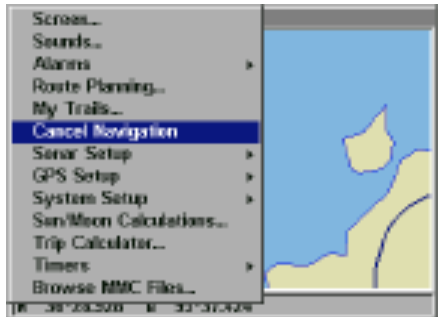

ROUTES

You can connect several waypoints together to form a route. When you recall the route, the unit shows navigation information to the first waypoint in the route, then when you reach that waypoint, it switches to the next waypoint, and so on until you reach the last waypoint in the route.

Create a Route

To create a route, first press the MENU key *twice*, highlight the “Route Planning” label, and press the ENT key. The screen shown at right appears.

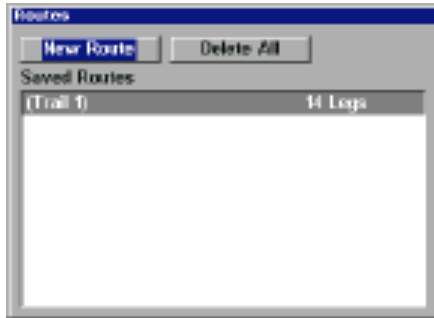

This unit can store up to 100 routes. To create a route, highlight “New Route” and press the ENT key. The screen at right appears.

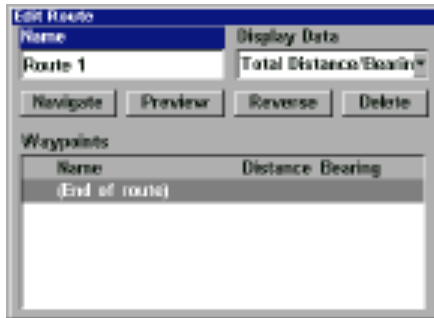

The route’s name appears at the upper left corner of the screen. Select it to change the name, if desired.

Now press the down arrow key until “Waypoints” is highlighted. Now press the ENT key. “End of route” is highlighted. Press the ENT key again. The “Edit Route Waypoints” menu appears as shown at right. You can add waypoints to the route from the map or from the waypoint list. In this example, we chose to add from the waypoint list. Selecting “Add Waypoint” brings up the “Find Waypoint” screen shown at right.



To add saved waypoints to the route, select “Saved” from the Subcategory list. To create a new waypoint for the route, select “New”. In this example, we’re using previously saved waypoints,

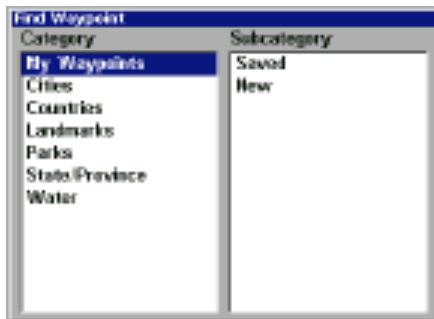

so “Saved” was chosen. A new menu appears, letting you choose from the list of names or from the nearest waypoint to your present position. In this example, “Name” was chosen. The screen at right appears.

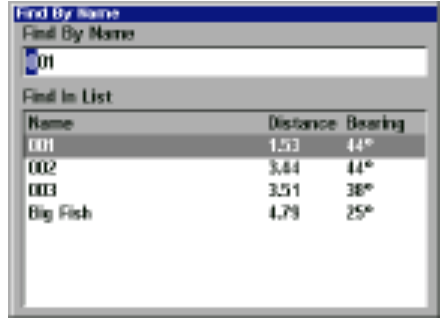

Select the first waypoint for the route from the list and press the ENT key. The screen at right appears.



Data for the selected waypoint shows on the left side of the screen. “Add To Route” is highlighted. To add this waypoint to the route, simply press the ENT key. The unit returns to the “Edit Route” screen with the first waypoint shown in the list as shown at right.

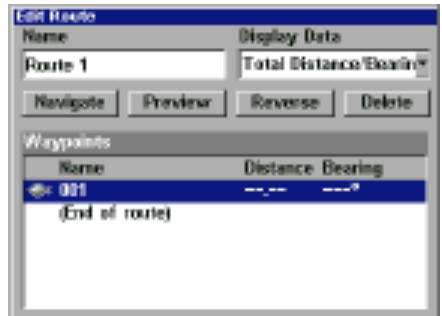

To add another waypoint to the list, first highlight “End of route” and press the ENT key. (Note: if you do not highlight “End of route”, the unit will place each waypoint that you select in front of the previous one, instead of after. This will result in a list of waypoints that’s reversed from the desired list.) The “Edit Route Waypoints” menu reappears. Continue selecting waypoints until all of the waypoints for the route have been chosen. When you’re finished making the route, press the EXIT key to erase the menus.



Follow a Route

To navigate a route, press the MENU key twice, then select "Route Planning". Using the arrow keys, highlight "Saved Routes" and press the ENT key. Select the desired route from the list. The "Edit Route" screen appears next.

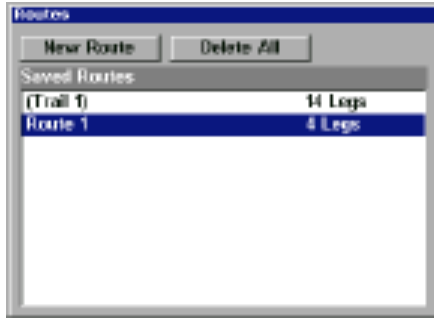

Now highlight "Navigate" and press the ENT key. The unit immediately begins showing navigation data to the first waypoint in the route. Once you reach the first waypoint, it will automatically switch to the second waypoint and so on, until you reach the last waypoint in the route. The unit will continue to show navigation data to the last waypoint in the route until you select "Cancel Navigation" from the second main menu page.



GPS Simulator

The GPS simulator lets you use the unit as if a GPS module was attached. You can set the starting location in latitude/longitude (Starting Position) or from a stored waypoint location (Select Starting Waypoint). You can steer your position on the map by using the arrow keys (Steer With Arrows) or by setting the track



and speed in the boxes provided on simulator screen. The altitude is also adjustable.

To use the GPS simulator, press the MENU key twice, then select "GPS Setup", then "GPS Simulator". The screen at the bottom of the previous page appears. Make the desired settings, then turn the simulator on by highlighting the "Simulator On" box and pressing the ENT key. Press the EXIT key to erase this menu. A message appears periodically, warning you that the simulator is on. Repeat the above steps or turn the unit off to turn the simulator off.

GPS SETUP

Items found under the GPS Setup menu include initialization, (covered at the beginning of this manual), position format, datums, and more. To use any of these features, first press the MENU key *twice*, highlight "GPS Setup" and press the ENT key. The screen shown at right appears.

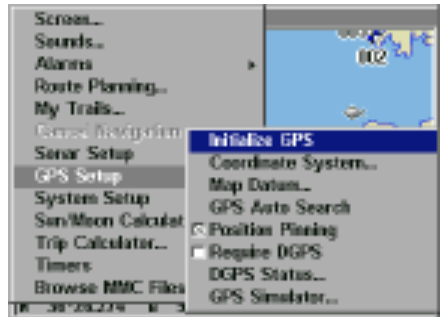

Coordinate System

This unit can show the position in degrees, minutes, and thousandths of a minute (36° 28.700') or degrees, minutes, seconds, and tenths of a second (36° 28' 40.9"). It can also show position in UTM (Universal Transverse Mercator) projection, Loran TD's, German, Taiwan, British, Irish, Swedish, Swiss, Finnish, New Zealand, and Military Grid.

To change the coordinate system, select it from the "GPS System" menu. The screen shown below appears.

UTM's are marked on USGS topographic charts. This system divides the Earth into 60 zones, each 6 degrees wide in longitude.

German, Taiwan, British, Irish, Swedish, Swiss, New Zealand, and Finnish grid systems are the national coordinate system used only in their respective countries. In order to use these grid systems



tems, you must be in the respective country. This unit will pick the matching datum for you when you select the grid. See the Datums section for more information.

The military grid reference system (MGRS) uses two grid lettering schemes, which are referred to as standard and alternate MGRS on this unit. Your position and datum in use determines which one to use. If you use standard, and your position is off significantly, then try the alternate.

Note: When the position format is changed, it affects the way all positions are shown on all screens. This includes waypoints.

Some screens have two position displays, standard, which is also shown on all other position displays, and alternate. The alternate position can be programmed to show your present position in a different format than the upper position. For example, you can show latitude/longitude and UTM's at the same time.

To change the coordinate system, press the ENT key while "Coordinate System" is highlighted. Press the up or down arrow keys to highlight the desired format. Press the ENT key to select it. Press the EXIT key to erase the menus.



Note: If the Loran TD conversion is chosen, you must enter the local loran chain identification for the master and slaves. Do this by selecting "Setup Loran TD" at the bottom of the "Coordinate System" menu and select the ID. Press the EXIT key to erase this menu.



Map Fix

Map Fix is used with charts or maps. This system asks for a reference position in latitude/longitude, which you take from a marked location on the map. It then shows the present position as distance on the map from that reference point. For example, if it shows a distance of UP 4.00" and LEFT 0.50", you then

measure up four inches and to the left a half-inch from the reference point on the map to find your location.

To use this format, you need to follow these steps in order. First, take your map of the area and determine a reference latitude/longitude. (Note: in order for this system to work, the latitude/longitude lines must be parallel with the edge of the map. USGS maps are parallel, others may not be. Also, this works better with smaller scale maps.) The reference position can be anywhere on the map, but the closer it is to your location, the smaller the numbers will be that you'll have to deal with.

Once you've decided on a reference position, you can save it as a waypoint. See the waypoint section for information on saving a waypoint. Save the reference position as a waypoint. Exit from the waypoint screens.

Now select "Configure Map Fix" from the "Coordinate System" menu. The screen at right appears. "Map Scale" is highlighted. Press the right arrow key. Enter the map's scale. This is generally at the bottom of the paper map. It's shown as a ratio, for example 1:24000. The unit returns to the Configure Map Fix screen. Now select "Select Origin Waypoint" if you saved the reference point as a waypoint or highlight the Latitude or Longitude under the "Origin" and enter the reference position. If you used "Select Origin Waypoint", then select the waypoint that you saved the reference point under. The unit returns to the Configure Map Fix menu.



Finally, press the EXIT key to erase this menu. Now select "Map Fix" from the list and press the ENT key. All position information now shows as a distance from the reference point you chose.

Datum

Maps and charts are based on a survey of the area that's covered by the map or chart. These surveys are called "Datums". Maps that are created using different datums will show the same latitude/longitude in slightly different locations.

All datums are named. The GPS system is based on the WGS-84 datum, which covers the entire world. Other datums may also cover the entire

world, or just a small portion. By default, your position shows using the WGS-84 datum. However, it can show your position using one of 191 different datums.

To change the datum, first press the MENU key, then highlight the “GPS Setup” label and press the ENT key. Now highlight the “Map Datum” label. Finally, press the ENT key again. A screen similar to the one at right appears.



The “WGS-84 - Default” label is highlighted. To change it, simply press the up or down arrow keys to highlight the desired datum, then press the ENT key. This selects the datum and erases the select datum menu.

A list of the datums used by this unit is in the back of this manual.

Position Pinning

When using a GPS receiver at extremely low speeds, it can have trouble determining your course over ground, or direction you’re travelling.

If you’re using this receiver without DGPS and stop, the position pinning feature locks the present position indicator on the plotter until you’ve moved a short distance or exceed a very slow speed. This prevents the “wandering” plot trail seen when you’re stopped with position pinning turned off. This also affects the navigational displays.

The easiest way to see the wandering is to stand still with the GPS receiver turned on and watch your plot trail with position pinning turned off. You’ll see the present position change, speed increase and decrease, and a random plot trail on the plotter’s screen.

If you wish to turn the position pinning feature off, press the MENU key, then highlight the “GPS Setup” label and press the right arrow key. Now highlight the “Position Pinning” label. Finally, press the ENT key. Reverse the above steps to turn it on again.

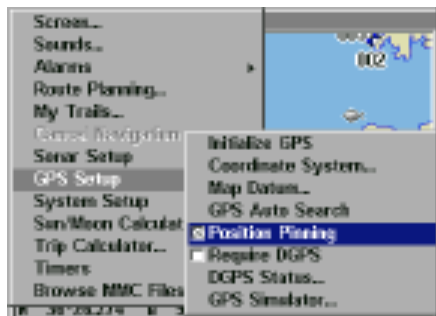

ALARMS

This unit has several GPS alarms. (Sonar alarms are covered in the sonar section of this manual.) You can set an arrival alarm to flash a warning message and sound a tone when you cross a preset distance from a waypoint. For example, if you have the arrival alarm set to .1 mile, then the alarm will flash a message when you come within .1 mile of the recalled waypoint. The course deviation indicator alarm (CDI) can warn when your track drifts too far to the right or left of the course line to the waypoint. For example, if the alarm is set to .1 mile, then the alarm flashes a message if you drift .1 of a mile or more to the right or left of the line to the waypoint. The anchor alarm is triggered when you drift outside of a preset radius. Again, using the .1 mile as an example, if you're anchored and your boat moves more than .1 of a mile, the alarm will flash a message and sound a tone.

To use any of these alarms, first press the MENU key *twice*, then select the "Alarms" menu. Next, select "GPS Alarms". A screen similar to the one shown at right appears. Press the up or down arrow key to select the desired alarm, then press the ENT key to turn it on or off.

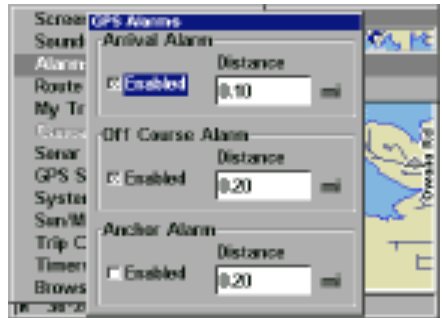

To adjust an alarm's distance, highlight the alarm's "Distance" menu, then press the ENT key to select it. Use the arrow keys to increase or decrease the alarm's distance.

When you're finished, press the EXIT key to erase this menu.

Important Alarm Notes:

Anchor Alarm - Since civilian users don't receive the accuracy given to military users, the anchor alarm may be triggered even when you're sitting still. This typically happens when using small (less than .05 mile) anchor alarm ranges. If you have a DGPS beacon receiver connected to this unit, smaller ranges may be usable.

Arrival Alarm - If you set the arrival alarm's distance to a small number, and you run a route (see the routes section), this unit may not show navigation data to the next waypoint, once you arrive at the first one, since you may not be able to come close enough to the first waypoint to trip the arrival alarm.

Trip Calculator

The Trip Calculator processes information on your current path and displays it in an easy to read format. When activated, it shows your current, average, and maximum speed, trip time and distance.

To turn the Trip Calculator on, press the Menu key twice, then select "Trip Calculator". A screen similar to the one at right appears. Now select "Trip Active" and press the ENT key. The unit begins calculating speed and distance data and displays it in the appropriate boxes on this screen.

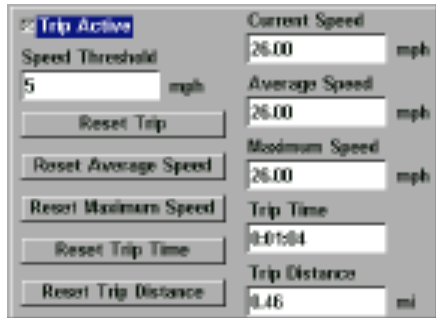

You can reset any of the parameters by selecting the appropriate button on the screen and pressing the ENT key.

Press the Exit key to erase the screen.

Timers/Alarm Clock

The LCX-15CI/15CT has two timers and an alarm clock. One timer counts down and the other counts up. The countdown timer counts down from the time that you enter until it reaches zero. The countup timer starts at zero and counts up to the time you entered. The alarm clock sounds a tone at the set time.



To set a timer or the alarm clock, press the MENU key twice, then select "Timers". The screen shown above appears. Select the appropriate timer or alarm. In the example at right, the up timer was selected. Select and enter the time that you wish the timer to run, then select "Up Timer" and press the ENT key. The timer begins running until it reaches the time you entered.

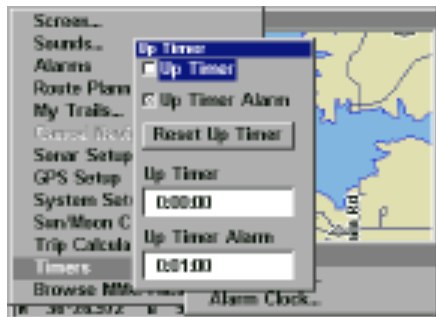

SONAR TROUBLESHOOTING

If your unit is not working, or if you need technical help, please use the following troubleshooting section before contacting the factory customer service department. It may save you the trouble of returning your unit.

Unit won't turn on:

1. Check the power cable's connection at the unit. Also check the wiring.
2. Make certain the power cable is wired properly. The red wire connects to the positive battery terminal, black to negative or ground.
3. Check the fuse.
4. Measure the battery voltage at the unit's power connector. It should be at least 11 volts. If it isn't, the wiring to the unit is defective, the battery terminals or wiring on the terminals are corroded, or the battery needs charging.

Unit freezes, locks up, or operates erratically:

1. Electrical noise from the boat's motor, trolling motor, or an accessory may be interfering with the sonar unit. Rerouting the power and transducer cables away from other electrical wiring on the boat may help. Route the sonar unit's power cable directly to the battery instead of through a fuse block or ignition switch
2. Inspect the transducer cable for breaks, cuts, or pinched wires.
3. Check both the transducer and power connectors. Make certain both are securely plugged in to the unit.

Weak bottom echo, digital readings erratic, or no fish signals:

1. Make certain transducer is pointing straight down. Clean the face of the transducer. Oil, dirt, and fuel can cause a film to form on the transducer, reducing its effectiveness. If the transducer is mounted inside the hull, be sure it is shooting through only one layer of fiberglass and that it is securely bonded to the hull. Do NOT use RTV silicone rubber adhesive or Marinetex
2. Electrical noise from the boat's motor can interfere with the sonar. This causes the sonar to automatically increase its Discrimination or noise rejection feature. This can cause the unit to eliminate weaker signals such as fish or even structure from the display.

3. The water may be deeper than the sonar's ability to find the bottom. If the sonar can't find the bottom signal while it's in the automatic mode, the digital will flash continuously. It may change the range to limits far greater than the water you are in. If this happens, place the unit in the manual mode, then change the range to a realistic one, (for example, 0-100 feet) and increase the sensitivity. As you move into shallower water, a bottom signal should appear.
4. Check the battery voltage. If the voltage drops, the unit's transmitter power also drops, reducing its ability to find the bottom or targets.

Bottom echo disappears at high speeds or erratic digital reading or weak bottom echo while boat is moving

1. The transducer may be in turbulent water. It must be mounted in a smooth flow of water in order for the sonar to work at all boat speeds. Air bubbles in the water disrupt the sonar signals, interfering with its ability to find the bottom or other targets. The technical term for this is Cavitation.
2. Electrical noise from the boat's motor can interfere with the sonar. This causes the sonar to automatically increase its Discrimination or noise rejection feature. This can cause the unit to eliminate weaker signals such as fish or even structure from the display. Try using resistor spark plugs or routing the sonar unit's power and transducer cables away from other electrical wiring on the boat.

No fish arches when the Fish ID feature is off:

1. Make certain transducer is pointing straight down. This is the most common problem if a partial arch is displayed.
2. The sensitivity may not be high enough. In order for the unit to display a fish arch, it has to be able to receive the fish's echo from the time it enters the cone until it leaves. If the sensitivity is not high enough, the unit shows the fish only when it is in the center of the cone.
3. Use the Zoom feature. It is much easier to display fish arches when zoomed in on a small range of water than a large one. For example, you will have much better luck seeing fish arches with a 30 to 60 foot range than a 0 to 60 foot range. This enlarges the targets, allowing the display to show much more detail.
4. The boat must be moving at a slow trolling speed to see fish arches. If the boat is motionless, fish stay in the cone, showing on the screen as straight horizontal lines.

NOISE

A major cause of sonar problems is electrical noise. This usually appears on the sonar's display as random patterns of dots or lines. In severe cases, it can completely cover the screen with black dots, or cause the unit operate erratically, or not at all.

To eliminate or minimize the effects of electrical noise, first try to determine the cause. With the boat at rest in the water, the first thing you should do is turn all electrical equipment on the boat off. Make certain the engine is off, also. Turn the sonar unit on, then turn off ASP (Advanced Signal Processing). There should be a steady bottom signal on the display. Now turn on each piece of electrical equipment on the boat and view the effect on the sonar's display. For example, turn on the bilge pump and view the sonar display for noise. If no noise is present, turn the pump off, then turn on the VHF radio and transmit. Keep doing this until all electrical equipment has been turned on, their effect on the sonar display noted, then turned off.

If you find noise interference from an electrical instrument, trolling motor, pump, or radio, try to isolate the problem. You can usually reroute the sonar unit's power cable and transducer cable away from the wiring that is causing the interference. VHF radio antenna cables radiate noise when transmitting, so be certain to keep the sonar's wires away from it. You may need to route the sonar unit's power cable directly to the battery to isolate it from other wiring on the boat.

If no noise displays on the sonar unit from electrical equipment, then make certain everything except the sonar unit is turned off, then start the engine. Increase the RPM with the gearshift in neutral. If noise appears on the display, the problem could be one of three things; spark plugs, alternator, or tachometer wiring. Try using resistor spark plugs, alternator filters, or routing the sonar unit's power cable away from engine wiring. Again, routing the power cable directly to the battery helps eliminate noise problems. Make certain to use the in-line fuse supplied with the unit when wiring the power cable to the battery.

When no noise appears on the sonar unit after all of the above tests, then the noise source is probably cavitation. Many novices or persons with limited experience make hasty sonar installations which function perfectly in shallow water, or when the boat is at rest. In nearly all cases, the cause of the malfunction will be the location and/or angle of the transducer. The face of the transducer must be placed in a location that has a smooth flow of water at all boat speeds. Read the transducer instructions for the best mounting position.

LOWRANCE ELECTRONICS, INC

FULL ONE-YEAR WARRANTY

"We", "our", or "us" refers to LOWRANCE ELECTRONICS, INC, the manufacturer of this product. "You" or "your" refers to the first person who purchases this product as a consumer item for personal, family, or household use.

We warrant this product against defects or malfunctions in materials and workmanship, and against failure to conform to this product's written specifications, all for one year (1) from the date of original purchase by you. WE MAKE NO OTHER EXPRESS WARRANTY OR REPRESENTATION OF ANY KIND WHATSOEVER CONCERNING THIS PRODUCT. Your remedies under this warranty will be available so long as you can show in a reasonable manner that any defect or malfunction in materials or workmanship, or any non-conformity with the product's written specifications, occurred within one year from the date of your original purchase, which must be substantiated by a dated sales receipt or sales slip. Any such defect, malfunction, or non-conformity which occurs within one year from your original purchase date will either be repaired without charge or be replaced with a new product identical or reasonably equivalent to this product, at our option, within a reasonable time after our receipt of the product. If such defect, malfunction, or non-conformity remains after a reasonable number of attempts to repair by us, you may elect to obtain without charge a replacement of the product or a refund for the product. THIS REPAIR, REPLACEMENT, OR REFUND (AS JUST DESCRIBED) IS THE EXCLUSIVE REMEDY AVAILABLE TO YOU AGAINST US FOR ANY DEFECT, MALFUNCTION, OR NON-CONFORMITY CONCERNING THE PRODUCT OR FOR ANY LOSS OR DAMAGE RESULTING FROM ANY OTHER CAUSE WHATSOEVER. WE WILL NOT UNDER ANY CIRCUMSTANCES BE LIABLE TO ANYONE FOR ANY SPECIAL, CONSEQUENTIAL, INCIDENTAL, OR OTHER INDIRECT DAMAGE OF ANY KIND.

Some states do not allow the exclusion or limitation of incidental or consequential damages, so the above limitations or exclusions may not apply to you.

This warranty does NOT apply in the following circumstances: (1) when the product has been serviced or repaired by anyone other than us, (2) when the product has been connected, installed, combined, altered, adjusted, or handled in a manner other than according to the instructions furnished with the product, (3) when any serial number has been effaced, altered, or removed, or (4) when any defect, problem, loss, or damage has resulted from any accident, misuse, negligence, or carelessness, or from any failure to provide reasonable and necessary maintenance in accordance with the instructions of the owner's manual for the product.

We reserve the right to make changes or improvements in our products from time to time without incurring the obligation to install such improvements or changes on equipment or items previously manufactured.

This warranty gives you specific legal rights and you may also have other rights which may vary from state to state.

REMINDER: You must retain the sales slip or sales receipt proving the date of your original purchase in case warranty service is ever required.

LOWRANCE ELECTRONICS, INC.
12000 EAST SKELLY DRIVE
TULSA, OKLAHOMA 74128
800-324-1356

DATUMS

WGS 1984 Default	Astro Tern Island (FRIG) 1961 - Tern Island	European 1950 Mean for Austria, Denmark, France, West Germany, Netherlands, Switzerland
Adindan Mean for Ethiopia, Sudan	Astronomical Station 1952 - Marcus Island	European 1950 Mean for Iraq, Israel, Jordan, Lebanon, Kuwait, Saudi Arabia, Syria
Adindan Burkina Faso	Australian Geodetic 1966 - Australia & Tasmania	European 1950 Cyprus
Adindan Cameroon	Australian Geodetic 1984 - Australia & Tasmania	European 1950 Cyprus
Adindan Ethiopia	Ayabelle Lighthouse - Djibouti	European 1950 Egypt
Adindan Mali	Bellevue (IGN) - Efate & Erromango Islands	European 1950 England, Channel Islands, Ireland, Scotland, Shetland Islands
Adindan Senegal	Bermuda 1957 - Bermuda	European 1950 Finland, Norway
Adindan Sudan	Bissau - Guinea-Bissau	European 1950 Greece
Afgooye Somalia	Bogota Observatory - Colombia	European 1950 Iran
Ain el Abd 1970 Bahrain	Bukit Rimpah - Indonesia (Bangka & Belitung Islands)	European 1950 Italy (Sardinia)
Ain el Abd 1970 Saudi Arabia	Camp Area Astro - Antarctica (McMurdo Camp Area)	European 1950 (Sicily)
Anna 1 Astro 1965 Cocos Islands	Campo Inchauspe - Argentina	European 1950 Malta
Antigua Island Astro 1943 Antigua (Leeward Islands)	Canton Astro 1966 - Phoenix Islands	Ireland 1965 Ireland
Arc 1950 Mean for Botswana, Lesotho, Malawi, Swaziland, Zaire, Zambia, Zimbabwe	Cape - South Africa	ISTS 061 Astro 1968 South Georgia Islands
Arc 1950 - Botswana	Cape Canaveral - Bahamas, Florida	ISTS 073 Astro 1969 Diego Garcia
Arc 1950 - Burundi	Carthage - Tunisia	Johnston Island 1961 Johnston Island
Arc 1950 - Lesotho	Switzerland	Kandawala Sri Lanka
Arc 1950 - Malawi	Chatham Island Astro 1971 New Zealand (Chatham Island)	Kerguelen Island 1949 Kerguelen Island
Arc 1950 - Swaziland	Chua Astro Paraguay	Kertau 1948 West Malaysia & Singapore
Arc 1950 - Zaire	Corrego Alegre Brazil	Kusaie Astro 1951 Caroline Islands
Arc 1950 - Zambia	Dabola Guinea	L.C. 5 Astro 1961 Cayman Brac Island
Arc 1950 - Zimbabwe	Djakarta (Batavia) Indonesia (Sumatra)	Leigon Ghana
Arc 1960 - Mean for Kenya, Tanzania	DOS 1968 New Georgia Islands (Gizo Island)	Liberia 1964 Liberia
Ascension Island 1958 - Ascension Island	Easter Island 1967 Easter Island	
Astro Beacon E 1945 - Iwo Jima	European 1950 Mean for Austria, Belgium, Denmark, Finland, France, West Germany, Gibraltar, Greece, Italy, Luxembourg, Netherlands, Norway, Portugal, Spain, Sweden, Switzerland	
Astro DOS 71/4 - St Helena Island		

DATUMS

Luzon Philippines (Excluding Mindanao)	North American 1927 Alaska	Ordinance Survey Great Britain 1936 - Mean for England, Isle of Man, Scotland, Shetland Islands, Wales
Luzon Philippines (Mindanao)	North American 1927 Bahamas (Except San Salvador Island)	Ordinance Survey Great Britain 1936 - England
Mahe 1971 Mahe Island	North American 1927 Bahamas (San Salvador Island)	Ordinance Survey Great Britain 1936 - England, Isle of Man, Wales
Massawa Ethiopia (Eritrea)	North American 1927 Canada (Alberta, British Columbia)	Ordinance Survey Great Britain 1936 - Scotland, Shetland Islands
Merchich Morocco	North American 1927 Canada (Manitoba, Ontario)	Ordinance Survey Great Britain 1936 - Wales
Midway Astro 1961 Midway Islands	North American 1927 Canada (New Brunswick, Newfoundland, Nova Scotia, Quebec)	Pico de las Nieves Canary Islands
Minna Cameroon	North American 1927 Canada (Northwest Territories, Saskatchewan)	Pitcairn astro 1967 Pitcairn Island
Montserrat Island Astro 1958 Montserrat (Leeward Islands)	North American 1927 Canada (Yukon)	Point 58 Sweden
M'Poraloko Gabon Nahrwan Oman (Masirah Island)	North American 1927 Canal Zone North American 1927 Cuba	Santo (DOS) 1965 Espirito Santo Island Sao Braz Azores (Sao Miguel, Santa Maria Islands)
Nahrwan Saudi Arabia	North American 1927 Greenland (Hayes Peninsula)	Sapper Hill 1943 East Falkland Island
Nahrwan United Arab Emirates	North American 1927 Mexico	Schwarzeck Nambia
Napariima BWI Trinidad & Tobago	North American 1983 Alaska, Canada, CONUS	Selvagem Grande Salvage Islands
North American 1927 Mean for Antigua, Barbados, Barbuda, Caicos Islands, Cuba, Dominican Republic, Grand Cayman, Jamaica, Turks Islands	North American 1983 Central America, Mexico Observatorio Metereo 1939 Azores (Corvo & Flores Islands)	SGS 85 Soviet Geodetic System 1985
North American 1927 Mean for Belize, Costa Rica, El Salvador, Guatemala, Honduras, Nicaragua	Old Egyptian 1907 Egypt Old Hawaiian Mean for Hawaii, Kauai, Maui, Oahu	South American 1969 Mean for Argentina, Bolivia, Brazil, Chile, Colombia, Ecuador, Guyana, Paraguay, Peru, Trinidad & Tobago, Venezuela
North American 1927 Mean for Canada	Old Hawaiian Hawaii	South American 1969 Argentina
North American 1927 Mean for CONUS (Continental United States)	Old Hawaiian Kauai	South American 1969 Bolivia
North American 1927 Mean for CONUS (East of Mississippi River) including Louisiana, Missouri, Minnesota	Old Hawaiian Maui	South American 1969 Brazil
North American 1927 Mean for CONUS (West of Mississippi River)	Old Hawaiian Oahu Oman Oman	South American 1969 Chile South American 1969 Colombia South American 1969 Ecuador

DATUMS

South American 1969
Ecuador (Baltra, Galapagos)

South American 1969
Guyana

South American 1969
Paraguay

South American 1969
Peru

South American 1969
Trinidad & Tobago

South American 1969
Venezuela

South Asia

Singapore

Tananarive Observatory 1925
Madagascar

Timbalai 1948
Brunei, East Malaysia
(Sabah, Sarawak)

Tokyo
Mean for Japan, Korea, Okinawa

Tokyo
Japan

Tokyo
Korea

Tokyo

Okinawa

Tristan Astro 1968
Tristan da Cunha

Viti Levu 1916
Fiji (Viti Levu Island)

Wake

Eniwetok 1960

Marshall Islands

Wake Island Astro 1952
Wake Atoll

WGS 1972
Global Definition

Yacare
Uruguay

Zanderij
Suriname

LOWRANCE DATABASES LICENSE AGREEMENT

THIS IS A LEGAL AGREEMENT BETWEEN THE END-USER WHO FIRST PURCHASES THIS PRODUCT AS A CONSUMER ITEM FOR PERSONAL, FAMILY, OR HOUSEHOLD USE ("YOU") AND LOW-RANCE ELECTRONICS, INC., THE MANUFACTURER OF THIS PRODUCT. ("WE", "OUR", OR "US"). USING THE PRODUCT ACCOMPANIED BY THIS LICENSE AGREEMENT CONSTITUTES ACCEPTANCE OF THESE TERMS AND CONDITIONS.

1. This License Agreement applies to the one or more databases that your product may contain. We refer to these singly as a "Database" and together as the "Databases." Your product may thus include the "WBS Database" which contains worldwide background surface mapping data, the "SmartMap Database" which contains inland mapping data, or other Databases.
2. The Databases that your product may contain are licensed, not sold. We grant to you the nonexclusive, nonassignable right to use these Databases for supplemental navigation reference purposes, but only as long as you comply with the terms and conditions of this License Agreement. We reserve the right to terminate this license if you violate any aspect of this License Agreement. You are responsible for using official government charts and prudent navigation for safe travel.
3. The Databases housed in your product are protected by the copyright notices appearing on the product or its screen(s). You may NOT modify, adapt, translate, reverse engineer, decompile, disassemble, rent, lease, or resell any Database, and you may NOT create derivative works based upon any Database or its contents.. Any unauthorized reproduction, use, or transfer of a Database may be a crime and may subject you to damages and attorney fees.
4. This License Agreement will terminate immediately without prior notice from us if you fail to comply with or violate any of the provisions of this Agreement. Upon termination, you will promptly return all products containing one or more Databases to us.
5. Prices and programs are subject to change without notice.
6. This License Agreement shall be governed by the laws of the State of Oklahoma and comprises the complete and exclusive understanding between you and us concerning the above subject matter.

DATABASES LIMITED WARRANTY

"We", "our", or "us" refers to Lowrance Electronics, Inc., the manufacturer of this product. "You" or "your" refers to the first person who purchases the product as a consumer item for personal, family, or household use. The Databases Limited Warranty applies to the one or more databases that your product may contain. We refer to each of these as a "Database" or together as the "Databases." Your product may thus include the "WBS Database" which contains worldwide background surface mapping data, the "SmartMap Database" which contains inland mapping data, or other Databases.

We warrant to you that we have accurately compiled, processed, and reproduced the portions of the source material on which the Databases are based. However, we are under no obligation to provide updates to the Databases, and the data contained in the Databases may be incomplete when compared to the source material. WE MAKE NO EXPRESS OR IMPLIED WARRANTY OF ANY KIND ABOUT THE ACCURACY OF THE SOURCE MATERIAL ITSELF, INCLUDING BUT NOT LIMITED TO IMPLIED WARRANTIES OF MERCHANTABILITY OR FITNESS FOR A PARTICULAR PURPOSE.

If there is a defect in any Database, your exclusive remedy shall be, at our option, either a refund of the price you paid for the product containing the defective Database or a replacement of such product. WE WILL NOT UNDER ANY CIRCUMSTANCES BE LIABLE TO ANYONE FOR ANY SPECIAL, CONSEQUENTIAL, INCIDENTAL, OR OTHER INDIRECT DAMAGE OF ANY KIND.

Some states do not allow the exclusion or limitation of incidental or consequential damages, so the above limitations or exclusions may not apply to you.

This warranty does NOT apply in the following circumstances: (1) when the product has been serviced or repaired by anyone other than us, (2) when the product has been connected, installed, combined, altered, adjusted, or handled in a manner other than according to the instructions furnished with the product, (3) when any serial number has been effaced, altered, or removed, or (4) when any defect, problem, loss, or damage has resulted from any accident, misuse, negligence, or carelessness, or from any failure to provide reasonable and necessary maintenance in accordance with the instructions of the owner's manual for the product.

We reserve the right to make changes or improvements in our products from time to time without incurring the obligation to install such improvements or changes on equipment or items previously manufactured.

This warranty gives you specific legal rights and you may also have other rights which may vary from state to state.

Your remedies under this warranty will be available so long as you can show in a reasonable manner that the defect occurred within one (1) year from the date of your original purchase, and we must receive your warranty claim no later than 30 days after such 1-year period expires. Your claim must be substantiated by a dated sales receipt or sales slip.

Saving and Replaying a Sonar Record

To save a sonar chart:

1. Press the MENU key.
2. Select "Sonar Chart Logging".
The screen at right appears.
3. To save the chart as "Chart 1", select "Start Logging" and press the ENT key. If you want to use a different file name, select "File Name" and name a new file. The Sonar Chart Logging menu is erased.
4. The unit records the current sonar data to the MMC.
5. To stop recording, select "Sonar Chart Logging" as shown above. Select "Stop Logging" from the menu. The menu is erased and the unit stops logging the chart data.



To replay a sonar chart:

1. Press the MENU key twice.
2. Select "Sonar Setup".
3. Select "Sonar Simulator".
4. Select "Chart Used" and choose the file name that you used when the chart was saved. In this example, it's "Chart 1.slg".
5. Select "Sonar Simulator On".
The unit will switch to the simulator mode, reading the chart data from the file that you saved on the MMC.

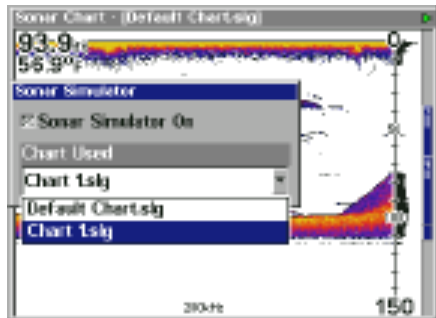

Transferring GPS Data to/from a MMC

To transfer waypoints, routes, icons, and plot trails from this unit to a MMC, press the MENU key twice, then select “System Setup”. Next, select “Transfer My Data”. The screen at right appears.



All data with check marks next to their labels will be transferred to the MMC. If you don't want a particular set of data to be transferred (for example: Icons), simply select it with the arrow keys, then press the ENT key.

Select “Save Data” and press the ENT key. This copies the data from the unit to the MMC.

To transfer data from the MMC to the unit, follow the above steps, but select “Load Data”.

How to Obtain Service

(Canadian Customers Only)

We back your investment in quality products with quick, expert service and genuine Lowrance replacement parts. If you need service or repairs, contact the Lowrance Factory Customer Service Department at the toll-free number listed below. A technician may be able to solve the problem and save you the inconvenience of returning your unit. You will be asked for your unit's serial number.

800-661-3983

905-629-1614

Canada Only.

How to Obtain Service

(International Customers Only)

If you need service or repairs, contact the dealer in the country you purchased your unit.

**WARRANTY REPAIR WILL BE HONORED ONLY IN THE COUNTRY
UNIT WAS PURCHASED.**

Please follow the shipping instructions shown below on this page if you have to mail your unit to the dealer. For proper testing, repair, and service, send a brief note with the product describing the problem. Be sure to include your name, return shipping address, and a daytime telephone number.

Shipping Information

When sending a product for repair, we recommend you do the following:

1. Always use the original shipping container and filler material the product was packed in when shipping your product.
2. Always insure the parcel against damage or loss during shipment. Lowrance does not assume responsibility for goods lost or damaged in transit.
3. For proper testing, repair, and service, send a brief note with the product describing the problem. Be sure to include your name, return shipping address, and a daytime telephone number.

Accessory Ordering Information

To order accessories such as power cables or transducers, please contact:

1. Your local marine dealer. Most quality dealers that handle marine electronic equipment should be able to assist you with these items. Consult your local telephone directory for listings.
2. Canadian customers only can write:
Lowrance/Lowrance Canada, 919 Matheson Blvd., E. Mississauga, Ontario L4W2R7
or fax 905-629-3118

How to Obtain Service (U.S.A. Only)

We back your investment in quality products with quick, expert service and genuine Lowrance® replacement parts. If you're in the United States and you have questions, please contact the Factory Customer Service Department using our toll-free number listed below. You must send the unit to the factory for warranty service or repair. Please call the factory before sending the unit. You will be asked for your unit's serial number (shown above). Use the following toll-free number:

800-324-1356

U.S.A. only. Monday through Friday, except holidays.

Your unit is covered by a full one-year warranty. (See inside for complete warranty details.) If your unit fails and the failure is not covered by the original warranty, Lowrance has a flat-rate repair policy that covers your unit and accessories packed with the unit at the factory. There is a 180-day warranty on all non-warranty repairs from the factory, which is similar to the original warranty, but is for 180 days rather than one year. For further details, please call us at the above number.

Remember, non-warranty repairs are subject to Lowrance's published flat-rate charges and 180-day warranty.

LOWRANCE ELECTRONICS, INC
12000 E. SKELLY DRIVE
TULSA, OK 74128
800-324-1356
<http://www.lowrance.com>

Accessory Ordering Information

To order accessories such as power cables or transducers, please contact:

1) Your local marine dealer. Most quality dealers that handle marine electronic equipment should be able to assist you with these items. Consult your local telephone directory for listings.

2) LEI Extras, Inc. P.O. Box 129 Catoosa, OK 74015-0129

or call

800-324-0045

(USA orders only.)

or see their website at <http://www.lei-extras.com>

Free Manuals Download Website

<http://myh66.com>

<http://usermanuals.us>

<http://www.somanuals.com>

<http://www.4manuals.cc>

<http://www.manual-lib.com>

<http://www.404manual.com>

<http://www.luxmanual.com>

<http://aubethermostatmanual.com>

Golf course search by state

<http://golfingnear.com>

Email search by domain

<http://emailbydomain.com>

Auto manuals search

<http://auto.somanuals.com>

TV manuals search

<http://tv.somanuals.com>