

To turn this feature on, simply press the 2nd key, then press the "4" key. The paper speed will immediately slow down, signifying that the function is enabled.

To turn the Alternate Transmit and Print feature off, simply press the 2nd key and then press the "7" key. The paper speed will immediately speed up, signifying that the function has been turned off.

When entering any number or combination of keys on the keyboard and you make a mistake, press the 2nd KEY, then 0. This

will clear the keyboard. For example, if you wanted to set a Lower Limit of 50 feet and pressed 40 feet instead, *before pressing the Lower Limit Key* press 2nd - 0 and the keyboard will be cleared. You could then press 5 - 0 - Lower Limit for the desired range.

To cause the X-15A to reprint the level of Discrimination, SCC, or Pulse Width at the bottom of the page, simply press 2nd and then the corresponding key (DISC, SCC/MARK, or PULSE) and it will be reprinted immediately.

Paper Saving Feature

APPROXIMATE PAPER SPEED Without Alternate Transmit and Print

LOWER LIMIT RANGE (feet)	Minimum Paper Speed		Maximum Paper Speed	
	Inches Per Min	Hours Per Roll	Inches Per Min	Hours Per Roll
10-120	1.0	10	2.35	4.25
130-510	0.5	20	1.4	7.14
520-830	0.15	66	0.75	13.3
Below 840	0.15	66	0.75	13.3

APPROXIMATE PAPER SPEED With Alternate Transmit and Print

LOWER LIMIT RANGE (feet)	Minimum Paper Speed		Maximum Paper Speed	
	Inches Per Min	Hours Per Roll	Inches Per Min	Hours Per Roll
10-120	0.5	20	1.4	7.14
130-510	0.20	50	0.8	12.5
520-830	0.15	66	0.75	13.3
Below 840	0.15	66	0.75	13.3

INSTALLATION AND OPERATION MANUAL

X-15A

COMPUTER SONAR



INDEX

Specifications	1
Service Information	1
Introduction	2
How It Works.....	2
Installation	3
Transducer Selection	4
Basic Operation	4
Suppressor	5
Paper Speed	6
GRAYLINE®	7
Range.....	7
Lower Limit	7
Upper Limit	8
Lines.....	9
Marker	9
Scale.....	9
End Of Paper	10
Zero Adjust	10
How To Read Graphs.....	10
Paper Loading	11
Stylus Replacement.....	14
Stylus Belt Replacement.....	15
Do's and Dont's.....	16
Troubleshooting	16
Advanced Operation.....	17
Surface Clarity Control (SCC)	17
Feet, Fathoms, Meters.....	18
Transmitter Pulse Width.....	18
Discrimination	20
Transmit and Print Alternate.....	21

level whereas the highest value (4) is the strongest level and should be used only when severe noise is present.

To use the Discrimination function, simply press the level of noise rejection desired, from 1 to 4, then press the DISC (Discrimination) Key. There should be an immediate change in the amount of noise present on the paper. The Discrimination setting is printed at the bottom of the paper each time the level is entered and at intervals thereafter.

The Discrimination function can be disabled at any time by pressing 0 - DISC.

Example: Enter a Discrimination level of 2.

Press: 2 - DISC

Result:

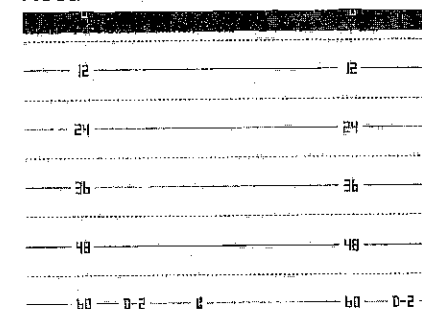

Figure 40

Transmit and Print Alternate

When using the X-15A in deep water, or if you wish to simply conserve paper, it may be desirable to slow the paper speed even more than the automatic system allows. However, when doing so, you may get "over print" or very dark, heavy printing over an area that is difficult to read. Much detail can also be lost due to this.

A feature that is available on the X-15A is the Transmit and

Print Alternate function which, when activated, causes the stylus to print every other revolution instead of every revolution. This accomplishes four things:

1. Since the stylus only prints every other revolution, the recorded information doesn't have the "over print" problem, therefore good records are attainable at slower paper speeds. Also, the scale numbers are spread out more, making them more legible.
2. Reduces the possibility of "wrap-around". This is the undesirable occurrence of the second or third bottom echo printed on the paper at the top or middle of the page. Many times this can interfere with fish or other targets that you wish to see.
3. Reduces the reverberation effect. This happens mainly on lower frequency units, but it can happen on higher frequency models. Reverberation is heavy, scattered noise marks caused by the transmitted signal becoming trapped between the surface and the bottom, usually scattered in heavy plankton layers or baitfish schools. This causes a great many lines to be printed on the page. By enabling the Transmit and Print function, the transmitter is triggered only half as many times as normal, putting less energy into the water (same amount of power, just not as often) which reduces the amount of noise seen.
4. Slows the paper speed. A significant amount of paper can be saved by using the Alternate Transmit and Print feature.

resolution.

For example, if a 50 μ s initial transmitter pulse length is selected, and the Suppressor control is rotated to maximum, the transmitter pulse length would be 850 μ s. Returning the Suppressor control to minimum will restore the unit to a 50 μ s transmitter pulse length.

The X-15A will display the initial transmitter pulse length at the bottom of the paper when you override the micro-computer. To distinguish the initial transmitter pulse from the other information printed on the paper, the graph will print P-100 (if the pulse is set to 100 micro-seconds.) A 50 μ s initial pulse length would be displayed as P-50.

To set the initial transmitter pulse length, simply press on the keyboard the initial pulse length desired and then press the PULSE key. For example, to set the initial transmit pulse length to 150 micro-seconds, press 1 - 5 - 0 - PULSE. This will override the micro-computer's selection and set the initial transmitter pulse length to 150 micro-seconds. P-150 will be printed at the bottom of the paper to signify that the entry has been confirmed. (Note: When an initial transmit pulse length is set, this length will be fixed for all depth settings until changed.)

To return control back to the micro-computer, press 0 - PULSE and the micro-computer will select the initial pulse length.

Example: Set the initial transmit pulse length to 100 micro-seconds.

Press: 1 - 0 - 0 - PULSE

Result:

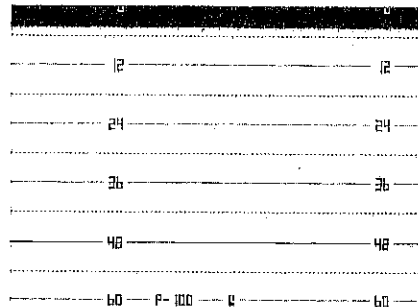

Figure 39

Discrimination

Noise pulses are the largest complaint most often received about sonar units. Lowrance has had the patented Suppression system for many years which is quite effective at eliminating noise from the display. (See Transmit Pulse Width.) The only drawback to the Suppression system is that it increases the transmitter's pulse length which decreases resolution and causes targets that are close together to merge into one "blob" instead of two distinct images.

Discrimination is a program installed in the X-15A's micro-processor that enables it to process the output from the receiver, determine which signals are noise and eliminate them, then print only the legitimate echoes.

Using this concept, the transmitted pulse does *not* have to be increased, therefore records with high resolution and high noise immunity can be achieved.

(The Suppressor Control may be used with the Discrimination to cancel OUT heavy interference or noise whenever high resolution is not required.)

There are four levels of Discrimination that can be used. The lowest value (1) is the weakest

SPECIFICATIONS — X-15A

Depth Ranges:

Feet, fathoms, meters.

Operating Frequency:

192 kHz (192,000 cycles per second); accuracy is within 0.6 percent.

Pulse Length:

(duration of pulse): 200-1000 μ s (30-2000 μ s programable)

Operating Voltage:

Minimum: 10 volts DC

Maximum: 15 volts DC

Operating Current:

0.7 to 1.8 amps depending on printing density and output power.

Output Power:

1600 watts typical peak-to-peak. (200 watts RMS)

Weight:

8.5 lb. (3.9 Kg)

Dimension:

With Gimbal Mount:

Width - 12 $\frac{1}{4}$ "

Height - 9"

Depth - 6 $\frac{5}{8}$ "

Instrument Only:

Width - 10 $\frac{1}{4}$ "

Height - 8 $\frac{1}{4}$ "

Depth - 6 $\frac{5}{8}$ "

NOTICE

Periodically wash the Transducer Face with soap and water to remove any oil film that may collect. Oil and dirt on the face

will reduce sensitivity or may even prevent sounding.

GOT A PROBLEM? LET US HELP!

If you have a problem with your sonar unit, please give us a chance to help before sending it in for repair.

Assistance can often be extended by telephone or letter. Write or call one of our Authorized Service Centers or the Lowrance Electronics, Inc., Customer Service Department in Tulsa, OK. (Toll-free 1-800-331-3889).

Please detail the problem you are experiencing. Our Service Department may be able to save you the inconvenience of returning your unit.

If it is determined that your unit must be returned, full shipping instructions will be provided.

SCHEMATIC DIAGRAM AND PARTS LIST

Should you desire a Schematic Diagram and Parts list for your Lowrance TRUELINE RECORDER, send \$1.00 to PARTS LIST, Lowrance Electronics, Inc., 12000 East Skelly Drive, Tulsa, Oklahoma 74128. Be sure and give us the Model Number and Serial Number of your SONAR INSTRUMENT.

NOTE: This sonar uses LPG-605 Chart Paper.

1. INTRODUCTION

The Lowrance X-15A is a highly sophisticated recording depth sounder. Thanks to a micro-computer, the X-15A can do more than any other sonar unit in its price range plus many that cost much more. Thanks to a waterproof keyboard, full control of the system is at your fingertips to meet the changing demands of varying bottom conditions, water depth, and boat speed. You can select the unit's sensitivity, suppression level, upper and lower depth range, paper speed, GRAYLINE, and many more features. The patented Lowrance variable suppression system combined with the new Discrimination feature not only filters out false signals without distorting the real ones, but is synchronized with the GRAYLINE function to provide clear signals under all conditions.

2. HOW IT WORKS

When the unit is turned on, an electronically regulated motor drives a lightweight belt located at the right edge of the recording paper. The stylus is attached to this belt. When the stylus is at the top of the paper a small mark is made. This is called the zero mark, and represents the surface of the water. The stylus continues

to move down the edge of the paper while the sound pulse is traveling through the water, and when an echo is detected, the stylus makes another mark on the paper. The depth of the object which reflected the echo can be read in feet by comparing its location on the paper to the depth scale printed on the paper.

The paper speed is controlled by a variable speed motor. During one revolution of the stylus belt, a very narrow mark will be made by the flexible stylus, but the paper will move a small amount before the next revolution. Each mark will blend into the one before so that a composite "picture" of the target will be made, one tiny mark at a time.

Due to the many features that this unit has, this manual has the operation section split into two parts. The first section is entitled "Basic Operation" and covers everything that is absolutely necessary to use the X-15A in a wide variety of situations. It will tell you how to use the basic controls - Sensitivity, Suppression, Paper Speed, GRAYLINE, Range, plus a few special functions. This section will be adequate for most situations. However, once you have mastered the basic operation of the X-15A, you may wish to try some of the features described in

the Suppressor control turned down to minimum when looking for fish.

However, it is helpful sometimes to have longer pulse width when resolution is not a concern. When using a sonar in deeper water, it is easier for the unit to detect a longer pulse coming back from the bottom or from fish. This is called "Probability of Echo Detection". The probability of the unit being able to detect an echo returning from deep water is diminished because the further the sound pulse has to travel, the weaker it becomes. By broadening the pulse length, in essence, a larger signal is transmitted and it is easier for the receiver to detect it.

For this reason, the micro-computer in the X-15A automatically increases the initial pulse length of the unit as deeper lower limits are set by the operator. (Note: Initial pulse length is the pulse length of the unit when the Suppressor control is turned to minimum.)

LOWER LIMIT (feet)	INITIAL TRANSMIT PULSE WIDTH (micro-seconds)
10	110
20	130
30	160
40-200	200

From 210 feet to 600 feet, the initial pulse length increases at the same rate as the depth. For example, with the LOWER LIMIT set to 260 feet, the initial transmit pulse length would be 260 μ s. If the LOWER LIMIT is set to 390 feet, the initial transmit pulse would be 390 μ s. Finally, from 600 feet and below, the initial

pulse length remains at 600 micro-seconds.

The transmit pulse length can be increased from the initial point at any time by rotating the Suppressor control clockwise. The maximum amount of pulse length added to the initial transmitter pulse length is approximately 800 micro-seconds. In other words, if the LOWER LIMIT is set to 420 feet, and the Suppressor control is rotated to the maximum position, the transmitter pulse length would be 1220 micro-seconds. (420 initial + 800 = 1220.)

Earlier, we talked about the relationship between pulse length and target separation. As pulse length increases, target separation or resolution is degraded. However, if the pulse width is decreased, resolution becomes much better.

The X-15A allows you to take advantage of this fact by making it possible to override the initial transmitter pulse length setting from what the micro-computer selects according to the Lower Limit.

The initial transmitter pulse length can be set from 30 μ s to 2000 μ s by entering it on the keyboard. By setting the initial transmitter pulse width to 100 μ s, a three inch resolution is obtained, 50 μ s is equivalent to an inch and a half, and 30 μ s initial transmit pulse length is equal to one inch resolution! No other graph recorder in the market today can give you this feature. After setting the initial transmitter pulse length, the suppressor control can still be used to cancel out noise by increasing the pulse length or the Discrimination function described below can be used to eliminate noise and still have good

Figure 1

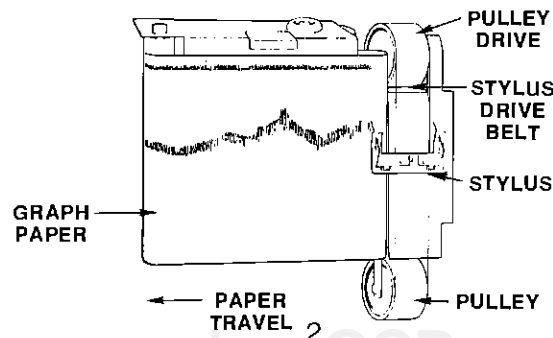

Feet, Fathoms, Meters

The X-15A will display the depth in feet, fathoms, or meters. Although the unit will revert back to the feet mode whenever power is turned off, it is simple to change to any mode you wish by pressing the 2nd key and then 1 for feet, 2nd - 2 for fathoms, and 2nd - 3 for meters.

When the unit is in the Feet mode, only one **L** will be displayed. In the Fathom mode, two **LL**'s will be displayed. Three **LLL**'s will be displayed in the meters mode.

Example: Display Fathoms

Press: 2nd - 2

Result:

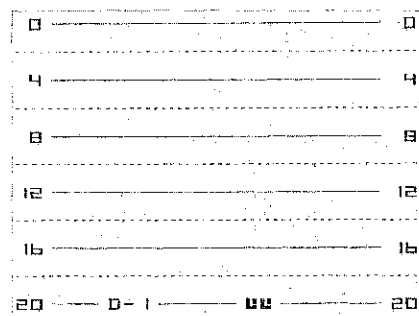

Figure 38

By looking at the number of **L**'s, one can determine the depth display mode that the unit is in, i.e., Feet-, Fathoms-, Meters.

Transmit Pulse Width

The noise suppression system in the X-15A is a patented pulse length discrimination suppression circuit, and is the same as the one used on all the Lowrance's variable suppression flashers and graphs. Basically, it works on the principle that most noise pulses are of relatively short duration. If the receiver circuit can be adjusted so that it will accept only

long pulses, then the short pulses will be cancelled out, and only the desired information (fish, bottom, structure, etc.) will be displayed. Of course, the transmitter's pulse length would have to be increased at the same time so that the return echoes would be accepted by the receiver.

This is exactly what the Lowrance suppression system does. The transmitter's pulse length is increased by the front panel suppression control, and the receiver "tracks" the amount of increased pulse length, cancelling out any narrow noise pulses, and displaying only the return echoes from fish or the bottom, etc. (Note: Receiver sensitivity is not diminished at all by this process.)

The only disadvantage to this system is resolution, or the ability to separate targets, is diminished when the pulse length is increased. A 200 μ s (micro-second) transmitter pulse length used on the X-15A when power is first turned on, will allow the unit to display two fish or targets that are only 6 inches apart. In other words, if two fish that are 6 inches apart are displayed on the graph paper, they will show up as two separate arches when the transmitter is operating with a 200 μ s pulse length. Now, if we increase the transmitter's pulse length to 400 μ s, (by rotating the Suppressor control clockwise) those same two fish arches will blend together and show up as one fish or possibly even a "blob" on the paper.

With a 400 μ s transmit pulse width, those same two fish will have to be at least 12 inches apart before they will show up as two separate arches on the graph. This is why it is important to leave

the section entitled "Advanced Operation". This chapter will describe several other features that will enable the serious operator to get the maximum benefit from this equipment.

We urge you to read this manual thoroughly and familiarize yourself with the controls. Although this is a very advanced unit, it is easy to use, thanks to the power of the micro-computer and the front panel controls. Should you require extra help, or just have a question, please call our Customer Service Department toll free 1-800-331-3889. (Oklahoma residents call collect - 1-918-437-6881.) Or check the enclosed list for a service center in your area. A representative will be happy to help you.

II INSTALLATION

Mounting —

The depth sounder may be installed in any convenient area, provided the unit can be tilted for the best viewing angle. Holes in the bracket base allow wood screw or bolt mounting. A wood stiffener may be required on the back of thin fiberglass panels to support the unit.

If the desired location is closer than 18" to a magnetic compass, a trial run should be made with the unit in operation to be sure

that the compass readings are not affected.

Power Connections —

Twelve volt DC power for the depth sounder should be supplied by the boat's 12 volt electrical system. The power cable may be attached to an accessory or power buss, but if you have problems with electrical interference, the cable should be attached directly to the battery.

If a longer cable is required, use ordinary #18 lamp cord available at any hardware or electrical supply store. Splices should be soldered, however, if this isn't done, then use crimp-type splices. Tape all splices with electrical tape.

An in-line fuse holder with fuse is supplied with the X-15A. Be certain to install this as close to the power source (such as the boat battery or power buss) as possible. This will protect both the sonar unit and the power cable in the event a short occurs. Crimp connectors are supplied to attach the fuse holder to the power cable. The red wire in the power cable is the positive conductor. The black wire is the ground or negative conductor.

The graph is protected from accidental polarity reversals and no damage will occur if the wires are reversed. The unit will not operate until the proper polarity is applied.

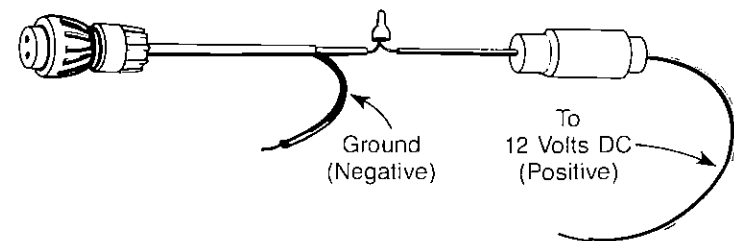

Figure 2

TRANSDUCER SELECTION

Lowrance offers you the choice of transducers with either an 8 degree or 20 degree cone angle that will interchange with any of our 192 kHz sonar units. In other words, any Lowrance sonar instrument can be used with any Lowrance transducer of the same frequency without retuning of any kind, and no loss of performance. However, the use of any other manufacturer's transducer will result in a loss of performance.

Now you can select the transducer design and cone angle to best fit your specific needs. Generally, wide cone angle transducers (20 degree) are ideally suited for operating in shallow water or at medium depths. The 20 degree cone angle allows you to see more of the underwater world. In 15 feet of water, the 20 degree cone angle allows you to see an area of the bottom that's approximately 6 feet across. The 8 degree transducer covers only about a 2 foot circle.

Figure 3

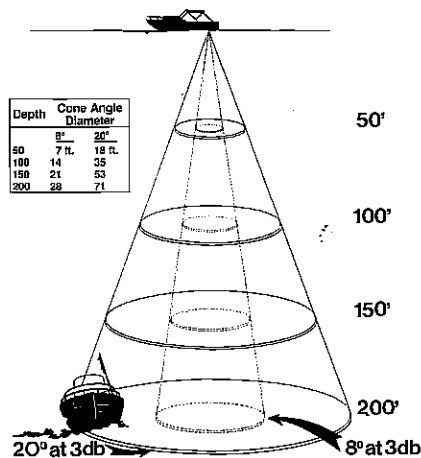

Thus, you would use a 20 degree transducer when looking for fish or structure, to easily find drop-offs, and to see fish that are around you. . . not just below you. However, the 20 degree transducer won't penetrate to greater depths as well as the 8 degree transducer, nor will it show a sharp drop-off as well. In a deep-water environment (100 feet or deeper) the narrow cone angle is more desirable because it can more accurately detect the location of the fish or drop-off in deeper water. Since the sound energy is concentrated in a smaller area, it can reach to deeper depths.

Both the 8 degree and the 20 degree Lowrance transducers give accurate bottom readings, even though the bottom signal is much wider on the 20 degree model because you are seeing more of the bottom. Remember, the shallow edge of the signal shows you the true depth. The rest of the signal tells you the composition of the bottom, i.e. whether you are over a soft or hard bottom, etc.

III BASIC OPERATION

On-Off and Sensitivity Control — Rotate the Sensitivity knob clockwise to turn the unit on. The Sensitivity knob works much like the volume control on a radio, that is, weaker signals will be detected with higher settings of the knob. When cruising, or at other times when just simple bottom contour information is desired, the Sensitivity setting can be low. In deep water or over soft, muddy bottoms, (which produce weak echos), the setting will have to be higher.

into the unit and the transducer is in contact with the water.

Symptom

The unit is "ON", but paper does not move.

What To Do

Tape paper to cardboard spool on take-up post.

Symptom

Recorder marks are faint or dim.

What To Do

Clean viewing door; replace the stylus; check battery connections.

Symptom

Recorded marks are very heavy; paper is torn by stylus.

What To Do

Bend the stylus slightly to reduce pressure on paper.

VI ADVANCED OPERATION

Surface Clarity Control (SCC)

The surface markings at the top of the chart paper can, at times, extend many feet below the surface. This often interferes with fish signals or other targets. This is called Surface Clutter and is caused by algae and plankton, air bubbles caused by wave action or boat wakes, bait fish, or tempera-

ture inversions.

The surface clutter markings can be reduced or eliminated by using the MARK/SCC control key on the front panel keyboard.

To use the SCC, press key 1 thru 4 and then the MARK/SCC key. 1 has a minimum effect on surface clutter, 4 has the maximum effect on reducing surface clutter. 2 and 3 have intermediate effects. The amount of SCC that is used is printed at the bottom of the chart paper. If one level of SCC is used, then S-1 is printed. Two levels, S-2, etc.

The effect on surface clutter should immediately be seen. Use only the amount of SCC required to reduce the clutter, as fish signals can be eliminated by using this method, also.

If you wish to turn the SCC function OFF, simply press 0-MARK/SCC and the SCC function will be disabled.

Example: ENTER A SCC LEVEL OF 2.

Press: 2 - SCC

Result:

(See Figure 37.)

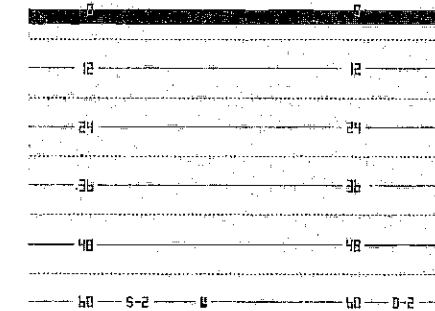

Figure 37

SCC "2"



wheels by reversing the procedure used to remove the old one. BE SURE the fingers of the new stylus are pointed UP.

6. Close the front of the case. Latch both catches at the top of the unit.

MAINTENANCE

NOTE: The stylus may be damaged if it is in front of the platen when the platen assembly is pulled down. Always move the stylus to the back side of the platen when changing the paper rolls. Remember to move the belt down to remove the stylus.

Black carbon dust is created during the recording process. Use a soft, oil-free rag to clean the viewing door and metal platen behind the paper. Low pressure compressed air may be used to blow dust out of the case and away from moving parts if the air is dry and free of oil.

All mechanical connections should be checked periodically to be sure they haven't worked loose.

HIGH VOLTAGE is present in the transmitter section when the unit is ON. No attempt should be made by any unauthorized person to modify or repair the electronic section.

All electrical connections should be checked periodically and cleaned as necessary.

The face of the transducer, if mounted on the transom should be washed periodically with mild soapy water to remove any accumulated rod grime or oily film. This is essential to have good contact between the transducer

and the water.

DO SECTION

Do carry a spare fuse, stylus belt, and roll of paper.

Do use the empty cardboard core from the last roll of paper on the take-up post.

Do keep the recorded graphs for future reference.

Do clean the stylus belt, wheels, and the rubber roller after every five rolls of paper.

DON'T SECTION

DON'T OPEN THE CASE WHEN THE UNIT IS ON.

Don't pull the platen assembly down when the stylus is at the front.

Don't store any objects inside the case or behind the viewing window. (Except for small pieces of tape.)

Don't forget to tape the paper to the take-up core.

Don't rotate the stylus belt up.

Don't use oily cloths, strong solvents, or abrasive cleansers.

TROUBLESHOOTING SECTION

Symptom

On/Off switch is "ON", but the stylus and paper don't move.

What To Do

Check fuse; check connections at battery for tightness and corrosion.

Symptom

On/Off switch is "ON", have zero mark, but no echoes or bottom signal.

What To Do

Be sure the transducer is plugged

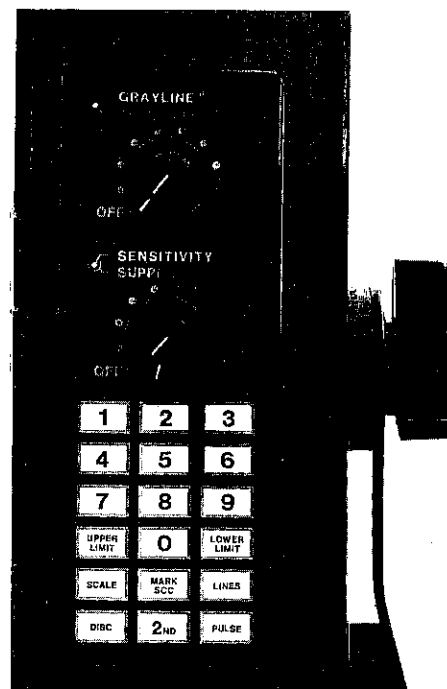
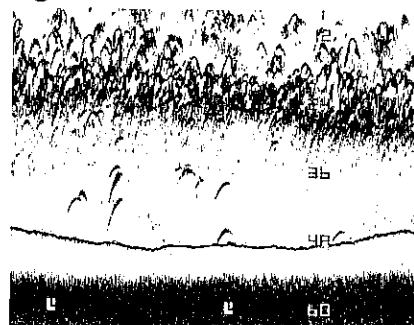

Figure 4

When high Sensitivity settings are used, a second bottom echo will appear. This is normal and is caused by the returning signal reflecting off the surface of the water, making a second trip to the bottom and back.

If detailed information about brush piles, individual fish, or the

Figure 5



SENSITIVITY: PROPER SETTING

thermocline is desired, the Sensitivity knob should be rotated to approximately the $\frac{3}{4}$ point. Refer to the illustration below to see

Figure 6

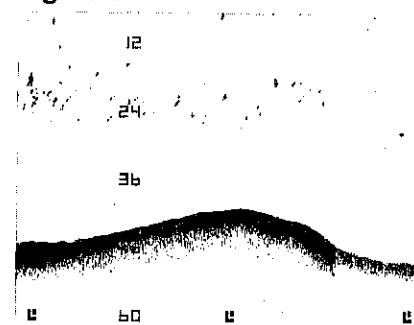

SENSITIVITY: TOO LOW

what effect the Sensitivity control setting has on the recorded information.

Recording individual fish with an "arched" signature can usually be accomplished at trolling speed with the Sensitivity knob at the $\frac{3}{4}$ point, or higher. Refer to the section "Arched Signatures" for more information about this important function of your recorder.

Suppression Control

The Suppression Control is used to reduce interference from noise. Noise, in electronic terms, is any undesired signal. It can be caused by an electrical source, (such as the engine's ignition system) or by air bubbles in disturbed water which is cavitation. In both cases, the noise could produce unwanted marks on the paper. (See Figures 7 & 8.) Fortunately, noise pulses are relatively short in time compared to real sonar signals. Advancing the Suppression knob will cause the system to reject these unwanted, short pulses without reducing the

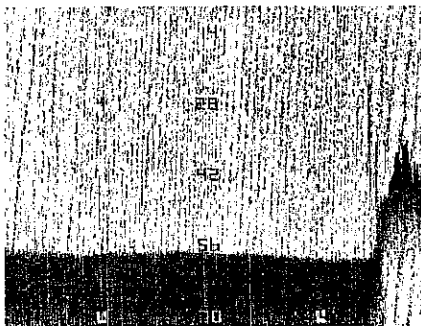

Figure 7

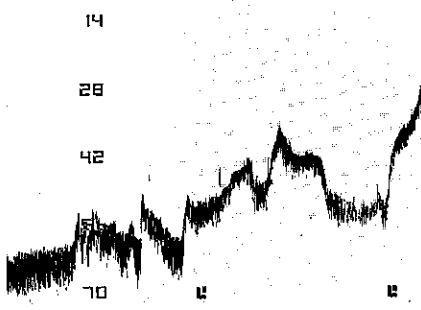

Figure 8

sensitivity in any way.

This patented design is exclusive with Lowrance. However, with high suppression settings, the graph record becomes coarse and the ability to separate fish from the bottom or from other fish will be decreased. (See Figure 9 & 10.) Therefore, the lower the suppression setting, the better. Advance the knob setting only as far as necessary to remove the er-

atic, unwanted noise marks. Most of the time at low or trolling speeds, no suppression will be necessary.

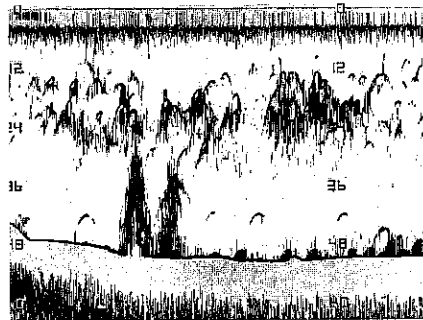

Figure 9 SUPPRESSION: TOO HIGH



Figure 10 PROPER SETTING

Paper Speed Control

This knob adjusts to speed of the chart paper. For good detailed graphs, in shallow to medium depths, turn the paper speed control up to at least the $\frac{3}{4}$ position when trolling. This will show prop-

APPROXIMATE PAPER SPEED Without Alternate Transmit and Print

LOWER LIMIT RANGE (feet)	Minimum Paper Speed		Maximum Paper Speed	
	Inches Per Min	Hours Per Roll	Inches Per Min	Hours Per Roll
10-120	1.0	10	2.35	4.25
130-510	0.5	20	1.4	7.14
520-830	0.15	66	0.75	13.3
Below 840	0.15	66	0.75	13.3

Figure 33

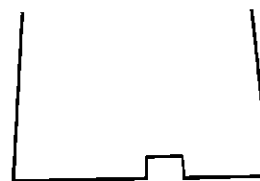

Figure 34

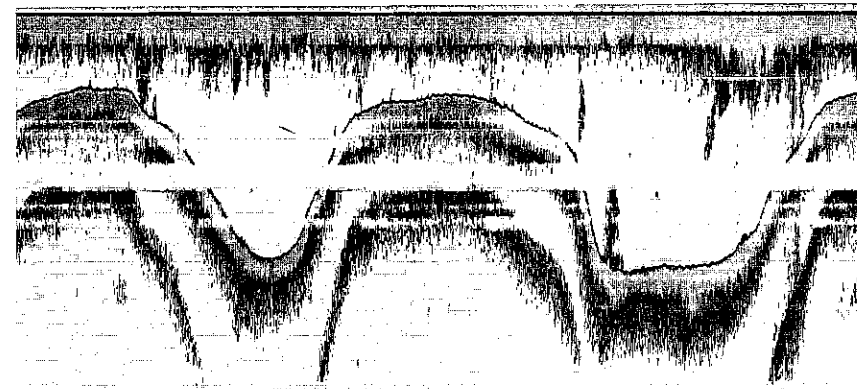
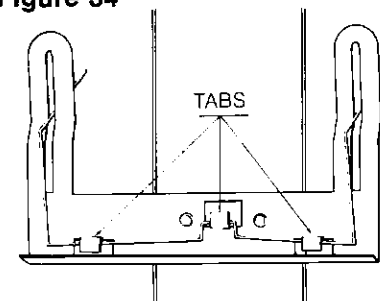

Figure 35

STYLUS BELT REPLACEMENT

CAUTION — High voltage is present in the electronic section when the unit is turned on.

1. TURN THE UNIT OFF.
2. Release both catches on the top of the case. Pull out and down on the top of the case front and the platen to expose the stylus belt.
3. The stylus belt rides over two wheels located at the right edge of the platen assembly. Refer to Figure 1 on page 2. Move the front of the belt DOWN to position the stylus at the center of the platen.
4. Grasp the belt at the stylus holder with the thumb and forefinger and move it gently



Figure 36

to the left while pushing the belt off the wheels with the other forefinger. (See Figure 36.)

5. Position the new belt on the

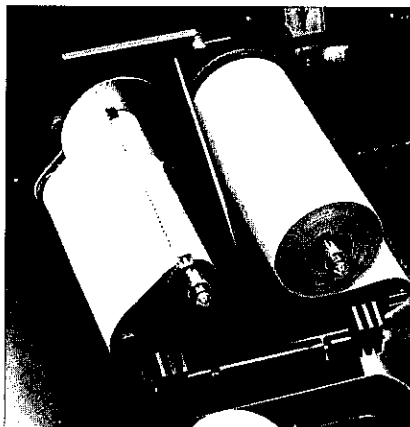

Figure 30



Figure 31

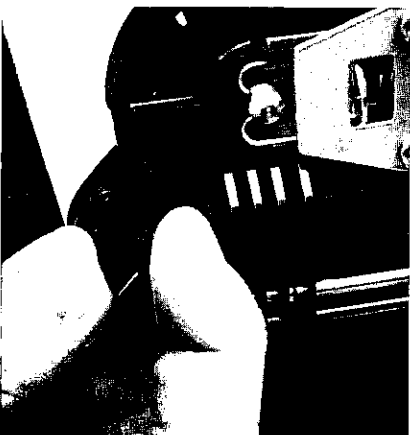

Figure 32

STYLUS REPLACEMENT

CAUTION — High voltage is present in the electronic section when the unit is turned on.

1. **TURN THE UNIT OFF.**
2. Release both catches on the top of the case. Pull out and down on the top of the case front to expose the stylus belt. (See Figure 25.)
3. The stylus belt rides over two wheels located at the right edge of the platen assembly. Move the front of the belt **DOWN** to position the stylus at the center of the platen.
4. Hold the stylus belt stationary with one finger, and remove the old stylus by starting at its left edge and moving it out from under the tabs on the stylus holder.
5. Before installing the new stylus, be sure it is bent properly by comparing it to Figure 33.
6. Refer to Figure 34 to be sure the new stylus is positioned correctly under the tabs on the holder. Be sure it moves freely in the two slots. If not, bend the stylus away from the edge it is rubbing on until it does move freely.
7. After installing, if the stylus won't print all the way down the paper as shown in Figure 35, bend the right leg down so that more pressure is exerted against the stainless steel plate. If it still does not print all the way, bend the left leg down more (but not so far that it digs into the paper).
8. Close the front of the case. Latch both catches on the top of the case.

er fish arches at low speeds and keeps high speed information from being compressed. The paper speed should be turned down when using the unit in deep water. This will prevent gaps from appearing in the record. In fact, the microcomputer will automatically slow the maximum speed of the chart paper when operating in deep water. The chart below gives the points where the maximum speed of the paper is slowed.

RANGE	PAPER SPEED
10'-110'	Fastest Paper Speed
120'-490'	Medium Fast Paper Speed
500'-790'	Medium Slow Paper Speed
800' & Below	Slowest Paper Speed

The chart paper may be slowed even further by adjusting the paper speed control. Remember, if gaps in the record appear, turn the paper speed down until a solid record is achieved. The paper speed may also be slowed when not looking for fish or to simply conserve paper. For more information about saving paper, read the Alternate Transmit and Print function in the Advanced Operation section.

GRAYLINE CONTROL

The GRAYLINE function can be used to outline the bottom contour which might otherwise be hidden beneath trees and brush; it can also give clues to the composition of the bottom. A hard bottom returns a very strong signal causing a wide gray line. A soft, muddy or weedy bottom returns a weaker signal which is emphasized with a narrow gray line. Do not advance

the control too far or it will gray line on the target completely, showing no black, which makes the target difficult to see.

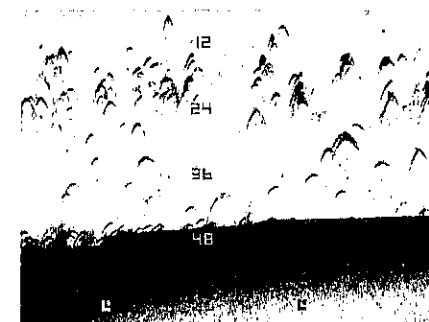

Figure 11 GRAYLINE "OFF"

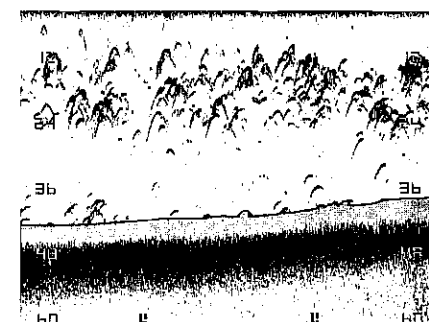

Figure 12 GRAYLINE "ON"

RANGE

The range function utilizes the keyboard to select any range between 0-10' and 2540'-2550'. Please read this section carefully to get the most out of your X-15A's range capabilities.

Lower Limit

When you first turn on the X-15A, the range will be 0-60 feet. (See Figure 13.)

To change to a deeper range, simply press the desired depth on the keyboard, and then press the LOWER LIMIT key.

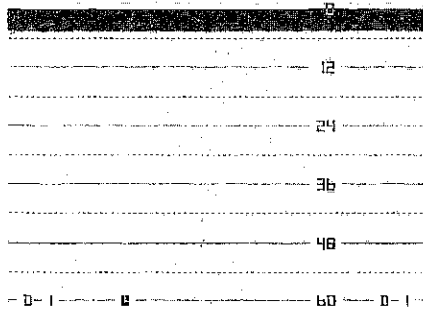

Figure 13

Example: Change range to 0-80 feet.

Press: 8 - 0 - LOWER LIMIT

The depth will then be displayed.

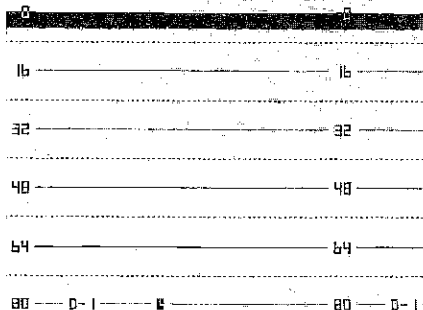

Figure 14

Any depth in a multiple of ten (10, 20, 30, 50, etc.) may be used as a lower limit displayed at the bottom of the chart paper.

Example: Change range to 0-150 feet.

Press: 1 - 5 - 0 - LOWER LIMIT

The depth will then be displayed: (See Figure 15.)

Note that the paper speed slows automatically at this range setting.

UPPER LIMIT

Many times it is desirable to ex-

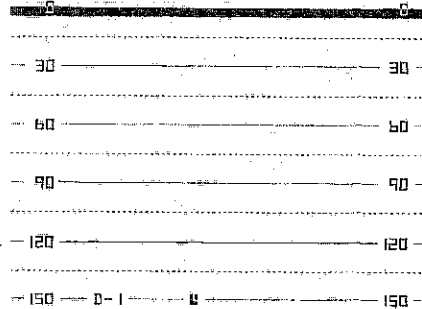

Figure 15

pend a section of the area that is displayed on the graph recorder to show more detail. This is made possible by the X-15A to show segments of the underwater world by using the UPPER LIMIT function. Using the UPPER LIMIT key allows you to display any depth range in multiples of 10 at the top of the chart paper.

Example: Turn on unit and set range to 20-60 feet.

Press: 2 - 0 - UPPER LIMIT

The depth will then be displayed.

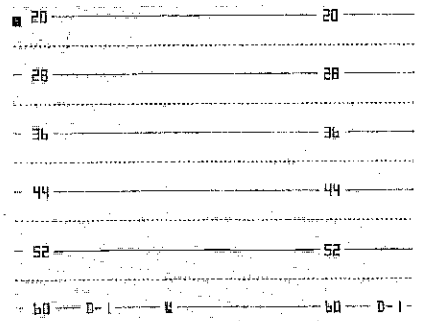

Figure 16

Example: Set range to 40-60 feet.

Press: 4 - 0 - UPPER LIMIT

The range will then be displayed: (See Figure 17.)

The Upper and Lower Limits can be used in various combina-

squarely to the take-up core. (See Figure 30.) Small pieces of tape may be stored inside the housing for this purpose. Close the top of the platen assembly by pressing the two tabs together on the paper retainer and returning the retainer back to the operating position. (See Figure 31.)

9. Turn the small knob at the upper left hand side of the platen assembly to put a small amount of tension on the paper. It should be snug against the platen. (Figure 32.)
10. Push the platen assembly back to its operating position. Be sure it engages the catch inside the top of the case.
11. Close the front of the case. Latch both catches on the top of the case.
12. Turn the unit on. Move the Chart Speed knob fully clockwise. Watch the paper long enough to be sure it is moving smoothly and evenly across the platen. If the paper flutters or begins to run "uphill", repeat step 8.

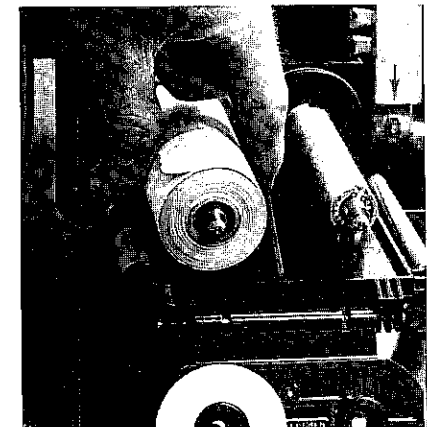

Figure 27

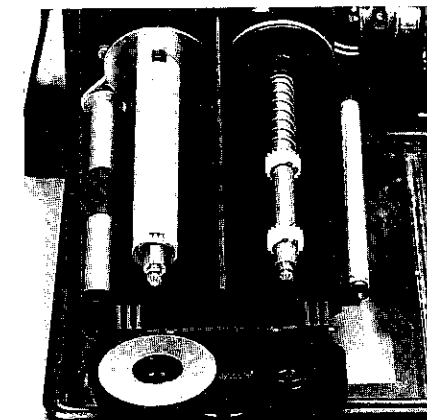

Figure 28

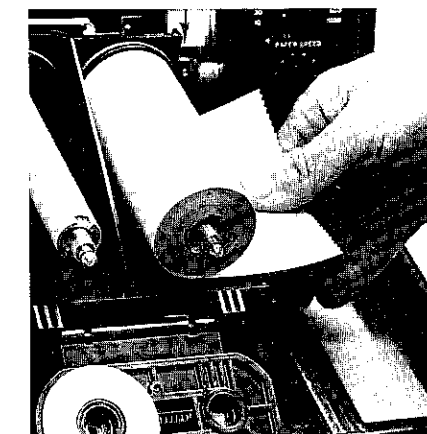

Figure 29

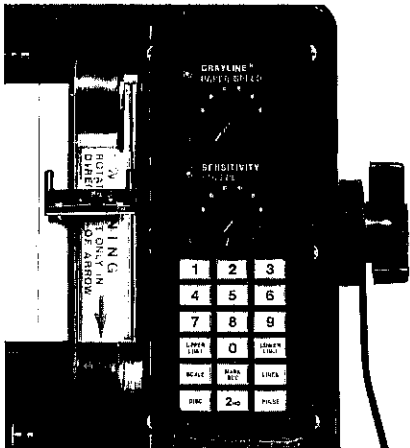

Figure 23

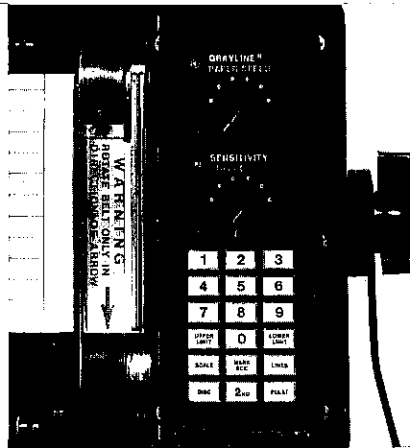

Figure 24



Figure 25



Figure 26

4. Pull out and down on the tab at the top center of the platen assembly to expose the paper spools. (See Figure 25.)
5. To remove the full take-up roll and the empty supply spool, press the two metal tabs together on the top of the platen assembly, and pull out and down on the paper retainer. (See Figure 26.) The full take-up roll can now be easily removed from the paper core shafts. (See Figure 27.)
6. Pull the empty supply core from the right side in the same manner. Install the empty core onto the take-up shaft. (See Figure 28.) Align the two notches in the core with the tabs on the lower take-up spool.
7. Slide a fresh roll of paper in position on the supply side shaft on the right side of the platen assembly. The paper must spool off the bottom of the roll. (See Figure 29.)
8. Draw the end of the paper across the face of the platen, around the friction roller, over the take-up core, and tape it

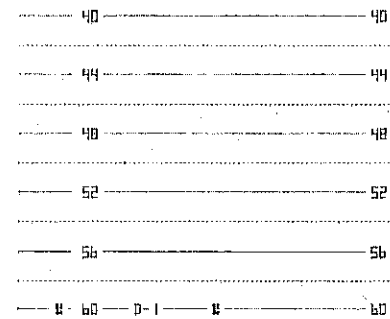

Figure 17

tions to show segments from the surface to the bottom and anywhere inbetween. Representative samples of chart paper are shown in the back of this manual.

If you wish to display your depth settings at any time, simply press either the UPPER LIMIT or LOWER LIMIT keys. The current range will be printed on the paper immediately. This will not change the depth setting.

LINES

When the X-15A is first turned on, depth lines will be printed on the paper. If you desire to turn the Lines off, press the LINES key. To turn the lines back on, press the LINES key again.

Example: Turn lines off:

Press: LINES key

Result:

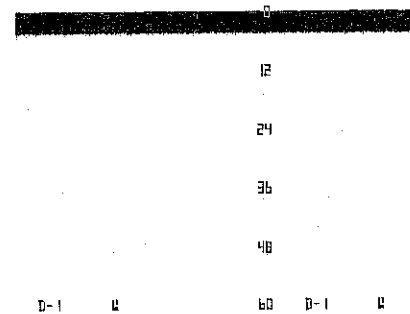

Figure 18

MARKER

An event marker function is included in the X-15A so that events may be marked when desired. To use the marker, simply press the MARK key and a vertical line will be displayed across the entire page. Hold the MARK key down and a vertical line will be printed for as long as the key is held down.

Example:

Press: MARK

Result:

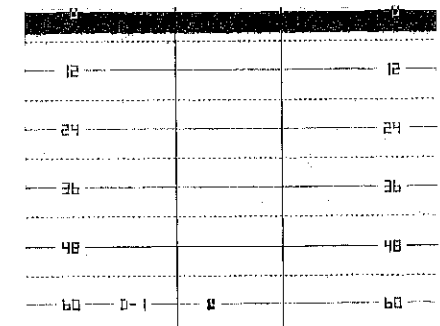

Figure 19

SCALE

The numbers that indicate the depth or scale may be deleted if desired. Pressing the SCALE key once will stop the printing of the scale numbers. The scale may be displayed again by pressing the SCALE key.

Remember, the scale may be displayed at any time by pressing either the UPPER LIMIT or the LOWER LIMIT key.

Example:

Press: SCALE

Result:

(See Figure 20)

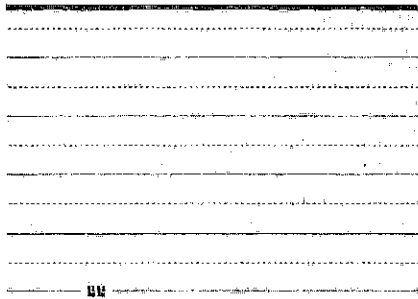

Figure 20

END-OF-PAPER MARKER

The graph paper in the X-15A has a red line printed at the bottom of the paper to signify when there is only 2 to 3 feet before the end of the paper.

ZERO ADJUST

Occasionally, when changing the stylus or stylus belt, the zero line does not print at the same place near the top of the chart paper.

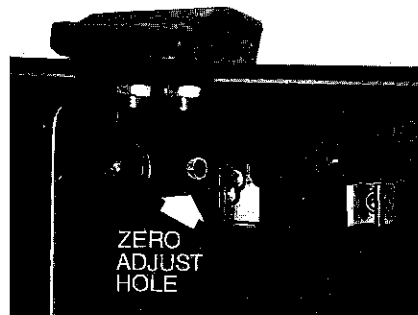

Figure 21

A zero adjust control has been placed on the back inside wall of the X-15A near the upper left hand corner so that the zero line's position may be adjusted on the paper.

Open the case front and look for the decal marked "ZERO ADJUST". You may have to pull the

paper transport assembly down to see the decal for the first time. Push the transport closed and turn on the unit. (Caution — Keep hands away from the stylus belt and stylus. High voltage is present.)

Insert a 6"-8" long screwdriver with a 1/8" blade into the zero adjust hole and rotate the control on the circuit board until the zero line is at the desired position. (Note: This may also be adjusted with the unit turned OFF. Adjust the control, then remove the screwdriver and turn power back ON. Repeat until the zero line is in the desired position.)

IV HOW TO READ GRAPHS

"Arched Signatures"

A remarkable advantage of the X-15A is that it can record individual fish with a characteristic arched mark that separates them from their stationary surroundings. The reason for this is shown below. The distance to a fish when it moves into the sonar's cone of sound is shown as "A". When the fish has moved to the center of the cone, the distance to it will be shorter, (line "B"), and as it moves out of the cone, the distance will increase again as shown in line "C".

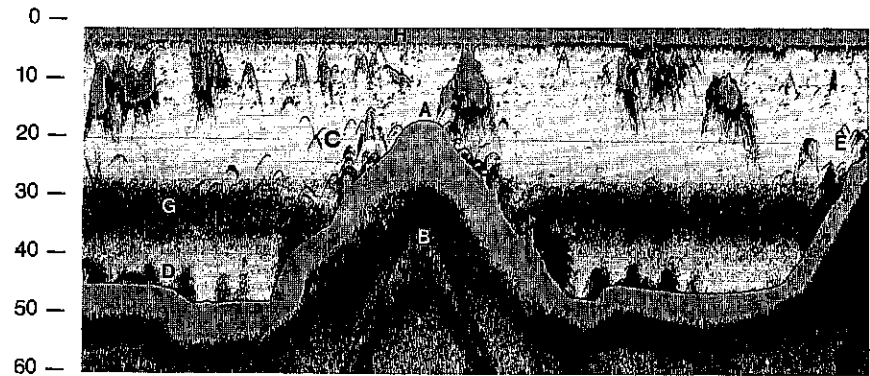
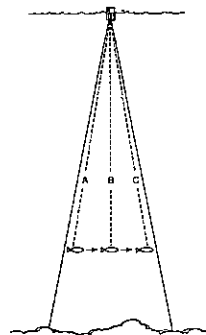

Figure 22

If a partial arch occurs most of the time on your unit, (the mark curves up, but not back down, or vice-versa) it is because the transducer is not pointed straight down. If your transducer is mounted on the transom, adjust the transducer until the fish show the distinctive arched signature. This may take some trial and error until the correct mounting is achieved.

Sharp, well defined signatures will occur most often when the Sensitivity knob is set at the 3/4 point, or higher. Remember, that there must be some movement between the boat and the fish to develop the arched mark. Usually this means trolling at very slow speeds with the main engine in gear at minimum throttle setting.

THERMOCLINES

The temperature of water in the lake is seldom constant from top to bottom. Layers of different temperatures form, and the junction of a warm and cool layer of water is called a thermocline. The depth and thickness of the thermocline can vary with the season or time of day. In deep lakes there may be two or more, at different depths. Thermoclines are important to the fisherman because they

are areas where fish are active. Many times bait fish will be above the thermocline while larger game fish suspend just below it.

Your Lowrance X-15A can detect this invisible layer in the water, but the Sensitivity knob will probably have to be set at the 1/2 point, or higher.

PAPER LOADING

CAUTION — High voltage is present in the electronic section when the unit is turned on.

1. TURN THE UNIT OFF.
2. Release both catches on the top of the case. Pull out and down on the top of the case front to expose the platen assembly. (See Figure 23.)
3. Move the stylus belt DOWN, to position the marking stylus on the back side of the platen. NEVER move the belt up — the stylus may be damaged. (See Figure 24.)

SPECIAL NOTE: The stylus may be damaged if the platen assembly is pulled down unless the stylus has been moved to the back side of the platen.

Free Manuals Download Website

<http://myh66.com>

<http://usermanuals.us>

<http://www.somanuals.com>

<http://www.4manuals.cc>

<http://www.manual-lib.com>

<http://www.404manual.com>

<http://www.luxmanual.com>

<http://aubethermostatmanual.com>

Golf course search by state

<http://golfingnear.com>

Email search by domain

<http://emailbydomain.com>

Auto manuals search

<http://auto.somanuals.com>

TV manuals search

<http://tv.somanuals.com>