



X71 Sonar

For Fish-finding & Depth Sounding

Installation and Operation

Instructions

Copyright © 2001 Lowrance Electronics, Inc.
All rights reserved.

Lowrance® is a registered trademark of Lowrance Electronics, Inc.

Lowrance Electronics may find it necessary to change or end our policies, regulations, and special offers at any time. We reserve the right to do so without notice. All features and specifications subject to change without notice. All screens in this manual are simulated.

**For free manual updates and other information,
visit our web site:
www.lowrance.com**

Lowrance Electronics Inc.
12000 E. Skelly Dr.
Tulsa, OK USA 74128-2486
Printed in USA.

Table of Contents

Introduction.....	1
Installation	1
Power connections.....	3
Transducer	4
Keyboard basics	5
Operation.....	7
Power/lights.....	7
Menus	7
Pages (Modes).....	7
Automatic	12
Sensitivity.....	13
Range	14
upper and lower limits	15
Zoom.....	17
automatic operation.....	18
manual operation.....	18
Grayline®	18
Chart speed	19
Fish I.D.™	20
FishTrack™	21
Chart setup.....	22
chart cursor	23
display zoom bar	23
display zone bar	24
digital sonar	24
Alarms	25
depth alarms	25
zone alarm.....	27
fish alarm	27
Adjust chart surface clarity.....	28
ASP™ (Advanced Signal Processing).....	28
System setup	29
audio/display.....	30
system information.....	31
units of measure	31
reset distance log	31
temperature graph	31
simulator.....	32
preset options.....	32
keel offset	32
calibrate speed.....	34
Windows summary	35
Troubleshooting	37
Warranty and service information.....	41

Introduction

The X71 is the latest member of the Lowrance® family that combines a high performance sonar with a wide screen. Using menu features and "soft-key" operation, the X71 is also one of the easiest to use sonars that Lowrance has ever built. The wide screen shows the underwater world with high resolution and detail. The display and keyboard are also lighted for night operation. The X71 is also capable of showing digital boat speed, surface water temperature and distance traveled. (Speed and distance information requires installation of an optional speed sensor.)

SPECIFICATIONS

- Dimensions: 5-7/8"H x 7-3/4"W x 3-7/8"D
- Transmitter Frequency: 200 kHz
- Transmitter Power: 1500 watts (peak-to-peak, typical)
188 watts (RMS, typical)
- Display: Film SuperTwist LCD, 5" diagonal viewing area
160 vertical pixels x 160 horizontal pixels resolution
25,600 total pixels

NOTICE!

The storage temperature for your unit is from -4 degrees to +167 degrees Fahrenheit (-20 degrees to +75 degrees Celsius). Extended storage in temperatures higher or lower than specified will damage the liquid crystal display in your unit. This type of damage is not covered by the warranty. For more information, contact the factory's Customer Service Department or your local service center.

Installation

MOUNTING

Install the X71 in any convenient location, provided there is clearance behind the unit when it is tilted for the best viewing angle. Holes in the bracket base allow wood screw or through-bolt mounting. You may need to place a piece of plywood on the back of thin fiberglass panels to secure the mounting hardware. Make certain there is enough room behind the unit to attach the power and transducer cables.

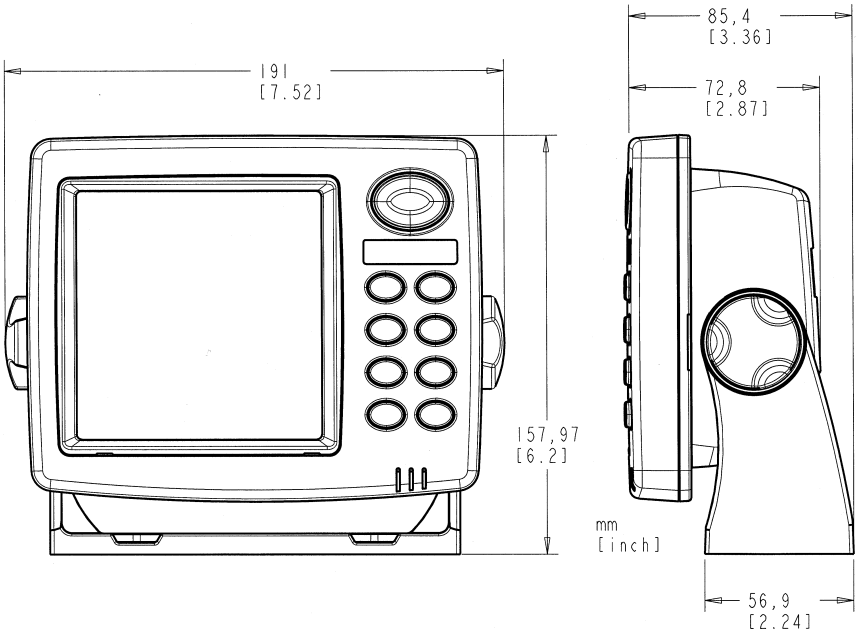

Front view (left) and side view (right) showing dimensions of X71 sonar unit when mounted on gimbal bracket.

The X71's gimbal bracket will also accept the GBSA-1 swivel bracket adapter that lets you rotate the unit a full 360°.

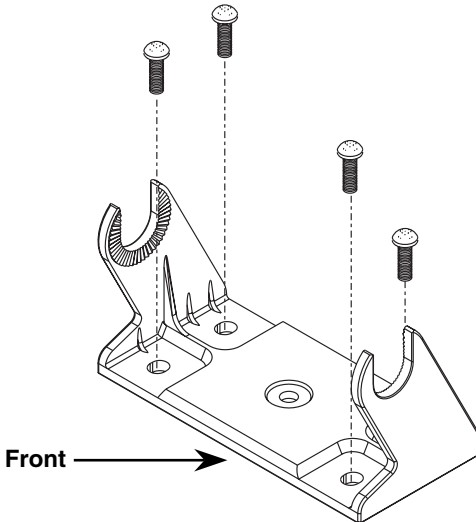

Install the gimbal bracket. Orient the bracket so the arms slope toward the front of your sonar unit.

The smallest hole that allows one power or transducer connector to pass through is 1". After the hole is drilled, push the transducer connector up through the hole first, then drop the power cable down through it.

After the cables have been routed, fill the hole with a good marine sealing compound. Offset the bracket to cover the hole. Route the power cable through the slot. Break out one of the holes in the back of the bracket for the transducer cable.

The X71 can also be mounted in the dash. The figure below shows dimensions for in-dash mounting.

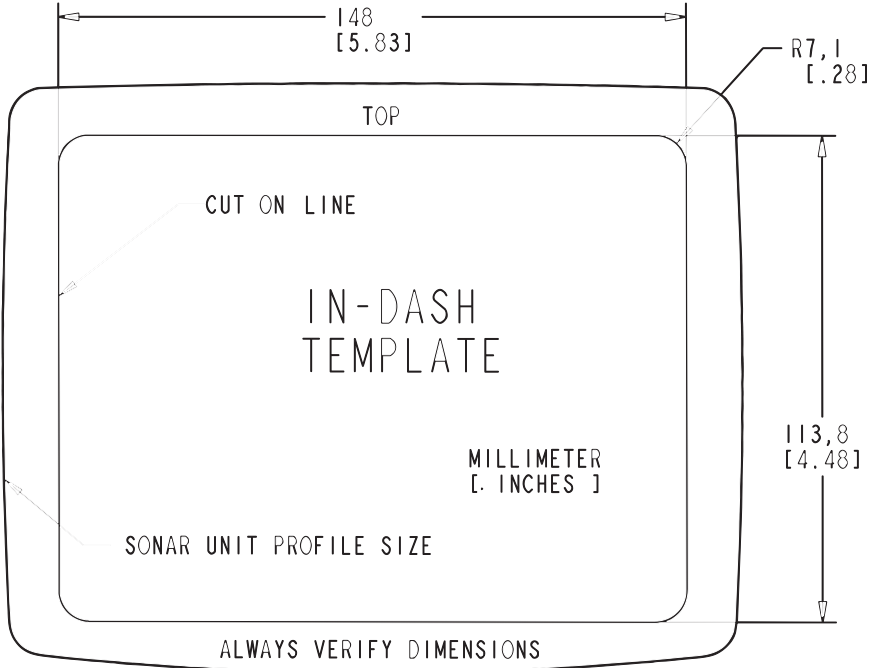

In-dash mounting template for X71 sonar unit, showing dimensions. NOTE: The figure above is *not* printed to scale. A scaled template is available for free download from our web site, www.lowrance.com.

POWER CONNECTIONS

The X71 works from a twelve-volt battery system. For the best results, attach the power cable directly to the battery. You can attach the power cable to an accessory or power buss, however you may have problems with electrical interference. Therefore, it's safer to go ahead and attach the power cable directly to the battery.

If the cable is not long enough, splice #18 gauge wire onto it. The power cable has two wires, red and black. Red is the positive lead, black is negative or ground. Make certain to attach the in-line fuse holder to the red lead *as close to the power source as possible*.

For example, if you have to extend the power cable to the battery or power buss, attach one end of the fuse holder directly to the battery or power buss. This will protect both the unit and the power cable in the event of a short. The X71 Plus requires a 3-amp fuse.

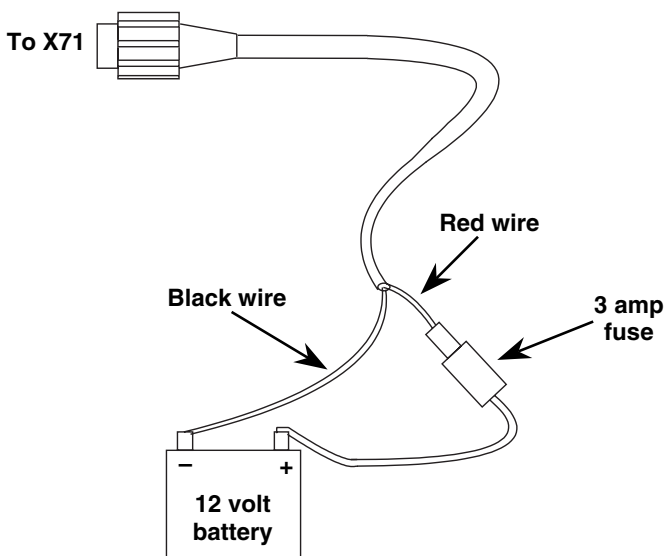

Power connections for the X71 sonar unit.

CAUTION:

Do not use this product without a 3-amp fuse wired into the power cable! Failure to use a 3-amp fuse will void your warranty.

TRANSDUCER INSTALLATION

Some X71s are packed with a HS-WSDX transom mount transducer. It can be installed on any outboard or stern-drive (inboard\outboard) powered boat. It can also be permanently installed inside the boat to "shoot-through" the hull on some fiberglass boats.

The "kick-up" mounting bracket helps prevent damage if the transducer strikes an object while the boat is moving. If the transducer does "kick-up", the bracket can easily be pushed back in place without tools.

Read the transducer's installation manual carefully before attempting

the installation. Determine which of the mounting positions is right for your boat. Use extreme care if mounting the transducer inside the hull, since once it is epoxied into position, the transducer usually can't be removed without damaging it. Remember, the transducer location is the most critical part of a sonar installation. If it isn't done properly, the sonar can't perform to its designed potential.

PORTABLE INSTALLATION

The X71 is also capable of portable operation by using the optional PPP-11 portable power pack. It has a storage compartment for the portable transducer. The power pack can be used with eight "D" cell alkaline batteries or an optional sealed, rechargeable battery.

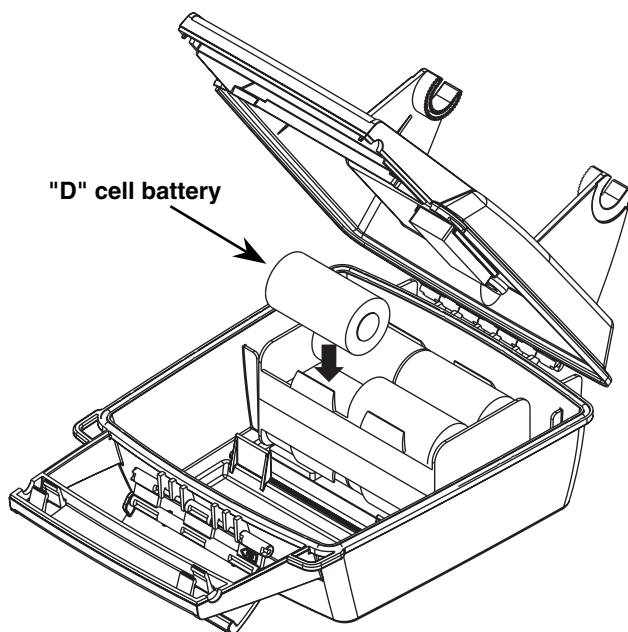

The X71 can be mounted on a portable power pack such as this.

KEYBOARD

The keyboard has keys arranged in two vertical columns beneath the arrow keys. The menu key near the bottom left corner of the keyboard activates the first menu page. The other keys are used to activate the alarm menu, make menu selections, and change pages.

Numbering in the following list corresponds with numbers in the following figure.

1. **PAGES** or **MODE** – Pressing this key switches the unit between different sonar pages. (On some units, this key says "Mode.")
2. **MENU** – Press this key to show the menus and gain access to most functions.
3. **ARROW KEYS** – These keys are used to make menu selections and to move objects on the screen.
4. **ZOUT** – This key lets you zoom the screen out to see more of the water column under your boat.
5. **ZIN** – This key lets you zoom the screen in to see greater detail.
6. **ALARM** – Press this key to activate any of the sonar alarms.
7. **PWR\LIGHT** – This key turns the unit and its lights on and off.
8. **ENT**– This key lets you accept values or screen formats.
9. **EXIT** – This key lets you return to the previous screen or erase a menu.



Lowrance X71 Sonar, front view, showing screen and keyboard.

Operation

POWER/LIGHTS

To turn the X71 on, simply press the **PWR** key. A screen similar to the one below appears.

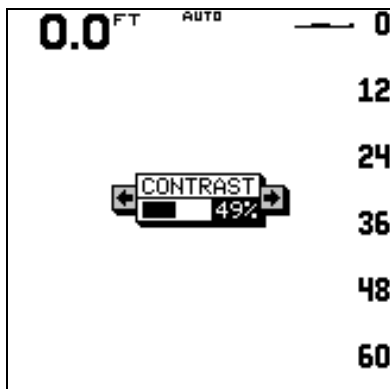

Opening screen.

The menu on this screen lets you adjust the screen contrast by pressing the left or right arrow keys. Press the **EXIT** key to erase this menu.

The **PWR** key also controls the lights. Once the X71 is turned on, press the **PWR** key to turn the lights on. Press the **PWR** key again to turn the lights off.

To turn the X71 off, press and hold the **PWR** key while a "countdown" appears on the screen. The unit will shut itself off when the countdown reaches zero. Release the **PWR** key.

MENUS

The X71 uses menus extensively to guide you through the functions and features of the unit. To use the menus, simply press the **MENU** key. The options on the menu let you to customize the unit to your particular needs and water conditions. Use the up and down arrow keys to move to different menus. The left and right arrow keys select and adjust menu items. If you ever get lost in a menu, simply press the **EXIT** key. This clears the menus from the screen.

PAGES or MODES

The X71 has five different pages: FasTrack™, digital/chart, split-chart, full chart and window groups. To select a page, simply press the **PAGES** (or **MODE**) key. A screen similar to the one on the top of page eight appears. Press the up or down arrow key to select the desired page,

then press **EXIT** key to erase the pages menu. A summary of the pages begins below.

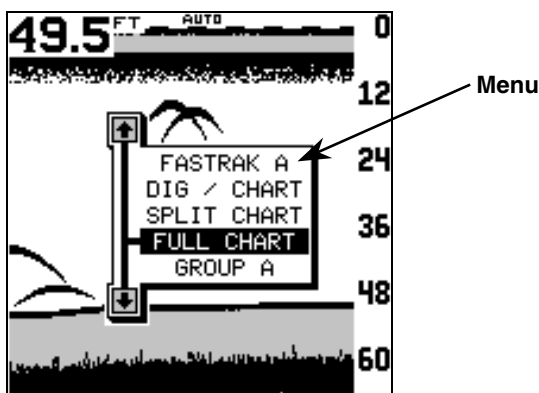

Menu showing five operating pages.

FasTrack™

There are two different versions of the FasTrack™ feature. The first one, (FasTrack "A") is shown below. The screen represents a flasher style sonar. A circular dial in the center of the screen shows all returning echoes at a high rate of speed. All digital functions are turned off while this page is in operation. No digital depth shows, *nor will any alarms work* while the FasTrack screen is displayed.

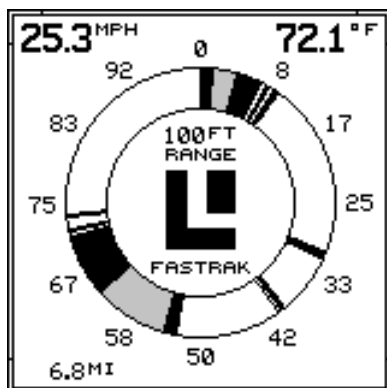

FasTrack "A" screen.

FasTrack "B" converts all echoes to short horizontal lines on the display's far right side (see figure at top of page nine). The graph continues to operate normally, except that it scrolls the echoes at high speed. This gives you a rapid update of conditions directly under the boat. It makes it useful for ice fishing, or when you're fishing at anchor.

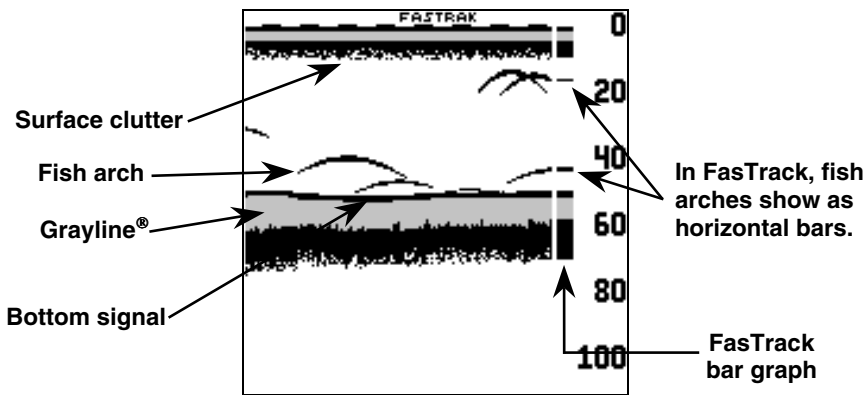

FasTrack "B" screen.

To switch to a FasTrack page, simply press the **PAGES (MODE)** key, then highlight the "FASTRK" label at the top of the screen. To switch FasTrack modes, simply press the left or right arrow keys while "FASTRK" is highlighted.

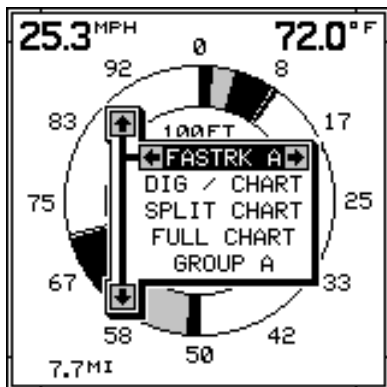

FasTrack menu screen.

CAUTION:

All alarms are shut off when either FasTrack mode is operating!

Full Chart

This is the default page used when the X71 is first turned on. The bottom signal scrolls across the screen from right to left. Depth scales on the right side of the screen makes it easy to determine the depth of fish, structure and other objects. The line at the top of the screen represents the surface. The bottom depth shows at the top left corner of the screen. The word "AUTO" at the screen's top center shows that the X71 is in the automatic mode, freeing you from sensitivity, range and noise rejection adjustments.

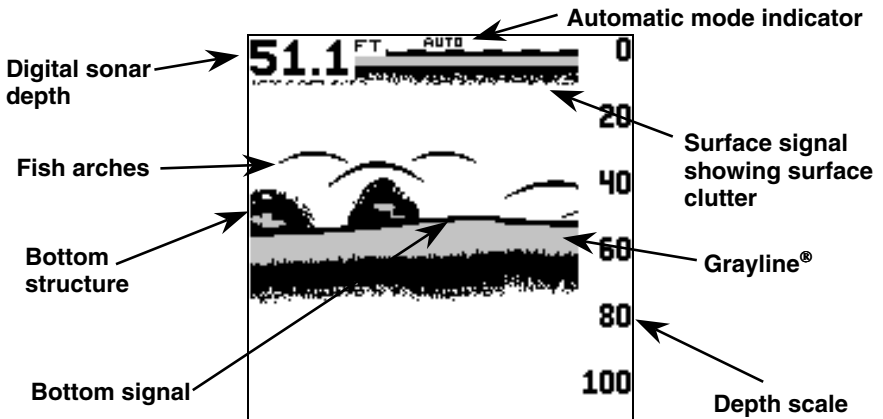

Full Chart screen.

Split Chart

A split chart shows the underwater world from the surface to the bottom on the right side of the screen. The left side shows an enlarged version of the right side. The zoom range shows at the bottom of the screen. In this example, the zoom range is 2X, or two times the right side's view. By pressing the **ZOUT** and **ZIN** keys, you can change the left side's zoom from 2X to 4X and back.

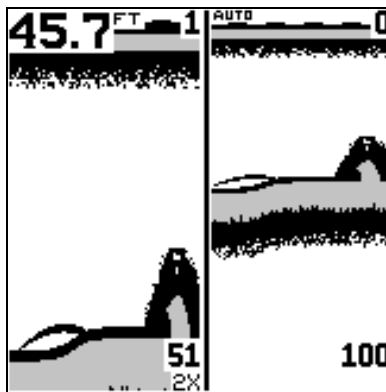

Split Chart screen.

Digital/Chart

The digital/chart shows the chart on the right side of the screen. The left side has four digital boxes containing the water depth at the top of the screen, boat speed, distance traveled (log) and surface water temperature. At the bottom of the screen is a temperature graph. **NOTE:** Speed and distance displays require an optional speed sensor

which must be purchased separately.

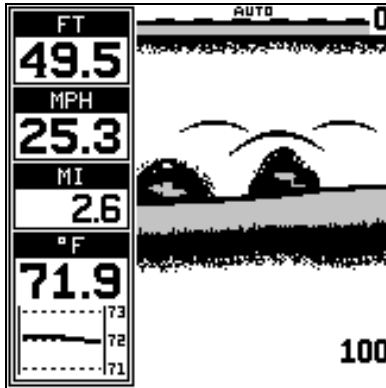

Digital/Chart screen.

Window Groups

You can change the displays on the X71 by using the windows feature. This lets you use different displays for your own fishing or boating situations. This feature gives you eight different screens in the window groups alone.

The screens available in the windows page are divided into two or more windows per screen. Each screen of windows is called a "group". Group "A" as shown below has the digital depth display in one window, battery voltage in another, water temperature, speed and distance traveled.

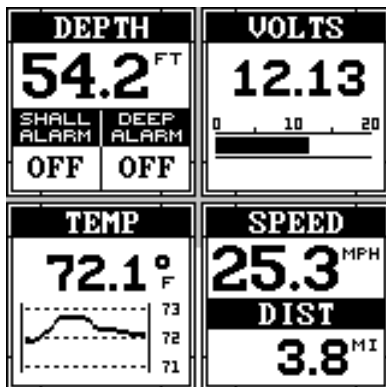

Window Group A.

To use the windows feature, first press the **PAGES** (or **MODE**) key. A screen similar to the one at the top of page 12 appears. Highlight the "Group" menu at the bottom of the screen. Now press the left or right

arrow keys to sequence through the groups. When the desired group appears, press the **EXIT** key to erase the menu.

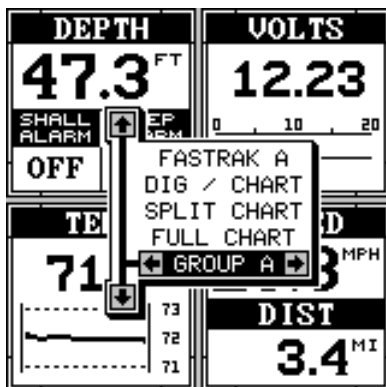

Window Group A menu.

AUTOMATIC

When the X71 is first turned on, the Automatic feature is enabled. This is indicated by the word "AUTO" at the top of the screen. The Automatic feature adjusts the sensitivity and range so the bottom signal is displayed in the lower half of the screen at all times.

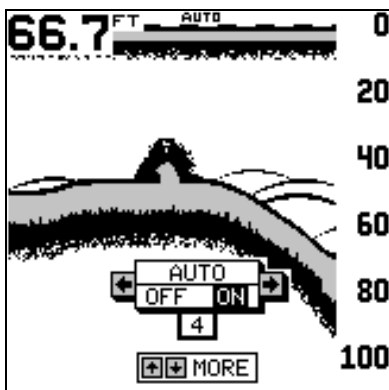

Automatic menu screen.

To turn Automatic off, first press the **MENU** key, then press the up or down arrow keys until the "AUTO" menu appears. Press the left arrow key to switch to the manual mode. The letters "Man" appear at the top of the screen, indicating the unit is in the manual mode. To turn Automatic on, repeat the above steps to get the auto menu, then press the right arrow key.

SENSITIVITY

The sensitivity controls the ability of the unit to pick up echoes. A low sensitivity level excludes much of the bottom information, fish signals and other target information. High sensitivity levels enables you to see this detail, but it can also clutter the screen with many undesired signals. Typically, the best sensitivity level shows a good solid bottom signal with Grayline and some surface clutter.

When the X71 is in the Automatic mode, the sensitivity is automatically adjusted to keep a solid bottom signal displayed, plus a little more. This gives it the capability to show fish and other detail.

However, situations occur where it becomes necessary to increase or decrease the sensitivity. This typically happens when you wish to see more detail, so an increase in sensitivity is indicated. The procedure to adjust it is the same whether the unit is in the automatic or manual mode.

To adjust the sensitivity, press the **MENU** key, then press the up or down arrow keys until the "SENS" menu appears as shown below.

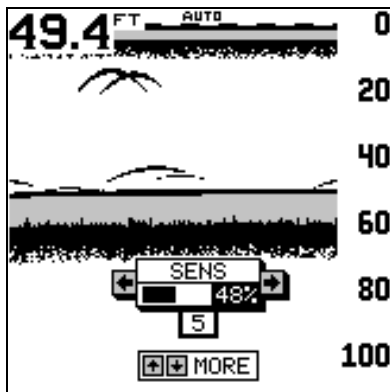

Sensitivity menu screen.

The sensitivity menu has left and right arrows, plus a horizontal bar graph. The graph gives a visual indication of the sensitivity level. The number to the right of the bar graph shows the percentage of sensitivity in use.

To increase the sensitivity level, press the right arrow key. As you press the key, the menu's bar graph will grow wider and the percentage will increase in value. You can also see the difference on the chart record as it scrolls. When the sensitivity is at the desired level, release the key.

To decrease the sensitivity level, press the left arrow key. The bar

graph and percentage will decrease. When the sensitivity is at the desired level, release the key. When you reach either the maximum or minimum limit, a tone sounds.

To erase the menu, press the **EXIT** key.

RANGE - Automatic

When turned on for the first time, the X71 automatically places the bottom signal in the lower half of the screen. This is called Auto Ranging and is part of the automatic function. Typically, the range cannot be changed manually while the unit is in automatic, as shown below.

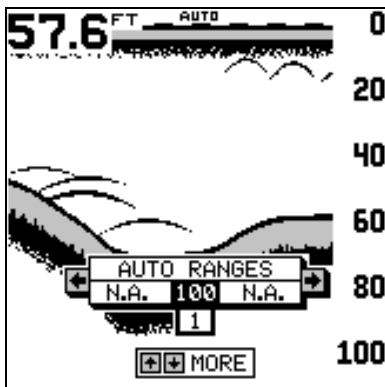

Auto Ranging mode.

However, depending upon the bottom depth and the current range, you can change the range to a different depth. In the example screen shown below, the bottom depth has descended to a point where you can change the range to 150 feet. To do this, simply press the right arrow key while the Auto Range menu is displayed. When you're finished, press the **EXIT** key to erase the menu.

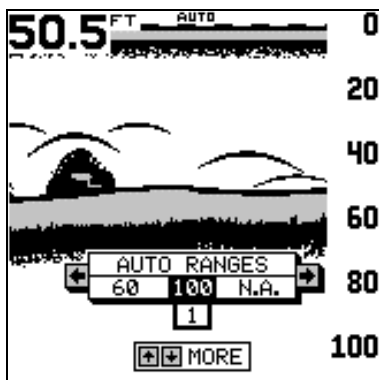

Press arrow key to change Auto Range depth.

RANGE - Manual

You have complete control over the range when the unit is in the manual mode.

To change the range, first make certain the X71 is in the manual mode. Next, press the **MENU** key and the up or down arrow keys until the range menu appears as shown below. Press the left or right arrow keys to decrease or increase the range. The available ranges are 0-5, 10, 20, 30, 40, 60, 100, 150, 200, 300, 500, 800 and 1000 feet. After the desired range is displayed, press the **EXIT** key to erase the range menu.

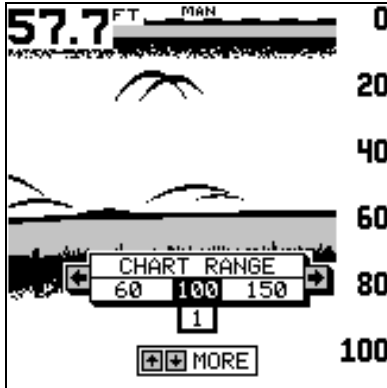

Press arrow key to change Manual Range depth.

NOTE:

The sonar's depth capability depends on the transducer installation, water and bottom conditions, and other factors.

UPPER AND LOWER LIMITS

You can enter any range when the unit is in the manual mode. The X71 lets you enter any upper and lower limit, provided there is at least ten feet separating them. (On the left screen at the top of page 16, the upper limit is 0 and the lower limit is 100.) Using the upper and lower limit range option, we changed the range from 0 to 100 feet to 35 to 65 feet. This "zoomed" the display to a 30 foot range (see the right figure at the top of page 16.)

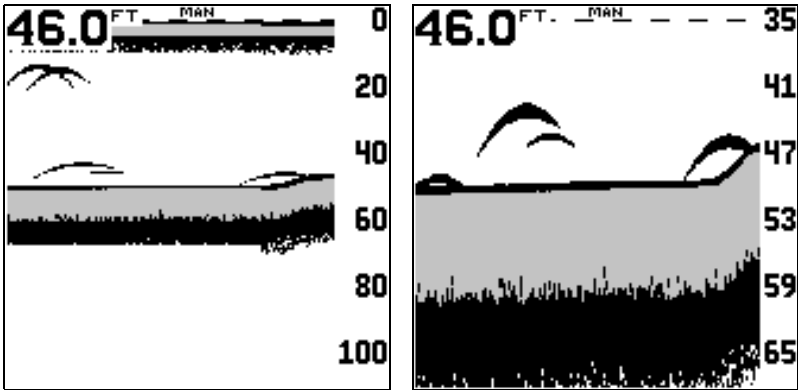

At left, the depth range upper limit is 0 and lower limit is 100. At right, changing the upper and lower limits zoomed in on the bottom detail.

As you can see, the fish arches near the bottom are much larger and easier to see. In fact, a possible fish on the bottom shows on the enlarged screen that is not even visible on the left! Not only does this make it easier to see targets, but you can more accurately determine their depth, due to the expanded depth range.

To change the upper and lower limits, first press the **MENU** key. Next, make certain the X71 is in the manual mode, then press the up or down arrow keys until the "Set Chart Limits" menu appears as shown below.

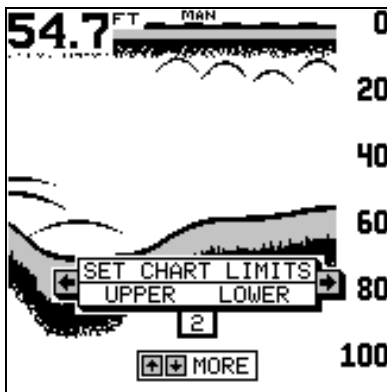

Setting the chart range (depth range) limits.

Now press the left arrow key to change the upper limit or the right arrow key to change the lower limit. A screen similar to the one at the top of page 17 appears.

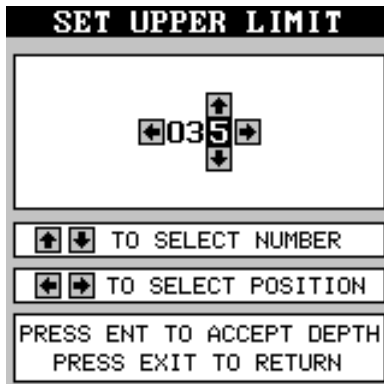

Use up and down arrow keys to select number; use left and right keys to select the number position

In this example, we're setting the upper limit. Use the up and down arrow keys to select the number, the right and left arrow keys to move to the next number. When the limit shows the desired depth, press the ENT key. The screen shown below appears.

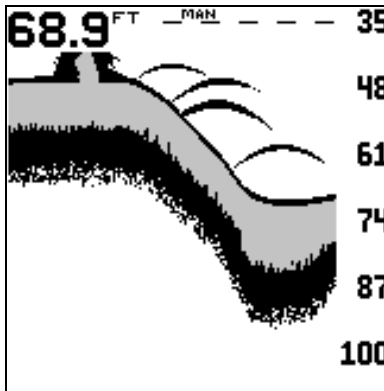

Upper limit changes to 35 feet.

As you can see, the upper limit has changed from 0 to 35 feet. If you want to change the lower limit, repeat the above steps, press the right arrow key on the "Set Chart Limits" menu, and change the lower limit to the desired value.

ZOOM

"Zooming" the picture is a common method used to enlarge small detail and fish signals. The X71 gives you two different zoom sizes, plus a split screen zoom option. The zoom operation and adjustment is different in the automatic and manual modes.

ZOOM - AUTOMATIC MODE

The only way to zoom the screen in automatic mode is to simply press the **ZIN** (zoom-in) key. This enlarges all echoes on the screen to twice their normal size. If you press the **ZIN** key again, the screen is "zoomed" to four times normal size. To return the screen to 2X or normal, simply press the **ZOUT** (zoom-out) key until the desired zoom appears. When the X71 is in the 2X or 4X zooms, "2X" or "4X" appears in the lower right corner of the screen, showing the current zoom mode.

ZOOM - MANUAL MODE

The **Z-IN** (zoom-in) and **Z-OUT** (zoom-out) keys enlarge and reduce the size of the echoes on the screen when the unit is in the manual mode, the same as the automatic mode.

However, you can manually adjust the zoom when the unit is in the manual mode. To do this, press the **MENU** key, then press the right or left arrow keys until the "CHART ZOOM" menu appears. Now press the right arrow key. A screen similar to the one below appears.

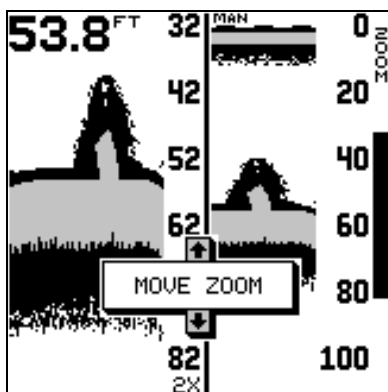

Split-screen Zoom menu.

This is the split-screen zoom menu. A zoom bar shows at the far right side of the screen. All echoes between the top and bottom of the zoom bar are shown on the left side of the screen. Pressing the up or down arrow keys moves the zoom bar up or down. As you adjust the zoom bar, the range changes on the left side of the screen at the same time.

To return to the full-screen mode, simply press the **EXIT** key. This also erases the zoom bar and move zoom menu.

GRAYLINE®

Grayline® lets you distinguish between strong and weak echoes. It "paints" gray on targets that are stronger than a preset value. This

allows you to tell the difference between a hard and soft bottom. For example, a soft, muddy or weedy bottom returns a weaker signal which is shown with a narrow or no gray line. A hard bottom returns a strong signal which causes a wide gray line.

If you have two signals of equal size, one with gray and the other without, then the target with gray is the stronger signal. This helps distinguish weeds from trees on the bottom, or fish from structure.

GRAYLINE is adjustable. Since GRAYLINE shows the difference between strong and weak signals, adjusting the sensitivity may require a different GRAYLINE level, also. The level chosen by the X71 at power on is usually adequate for most conditions. Experiment with your unit to find the GRAYLINE setting that's best for you.

To adjust the GRAYLINE level, press the **MENU** key, then press the up or down arrow keys until the GRAYLINE menu appears. A screen similar to the one below appears.

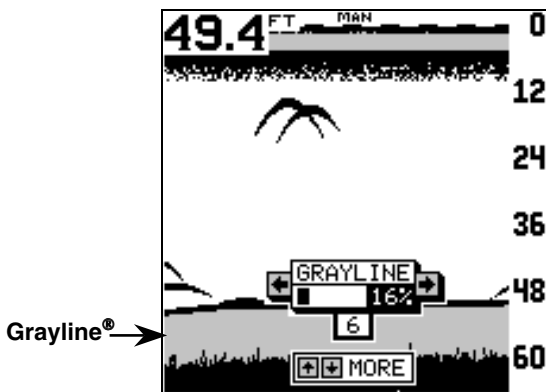

Grayline menu screen.

Press the left arrow key to decrease the gray level or the right arrow key to increase it. The percentage of GRAYLINE in use changes as the arrow keys are pressed. The bar chart also gives a graphical indication of the GRAYLINE level. You can see the change on the screen (both on the menu and on the chart record) as you press the keys. After you've finished, press the **EXIT** key to erase the menu.

CHART SPEED

The rate echoes scroll across the screen is called the chart speed. It's adjustable by first pressing the menu key, then pressing the up or down arrow keys until the "CHT SPD" (chart speed) menu appears as shown in the left figure at the top of page 20. Increase the chart speed by pressing the right arrow key or decrease it by pressing the left arrow

key. The percentage of chart speed in use changes as the arrow keys are pressed. The bar chart also gives a graphical indication of the chart speed. You can see the change on the screen (both on the menu and on the chart record) as you press the keys. After you've made the adjustment, press the **EXIT** key to erase the menu.

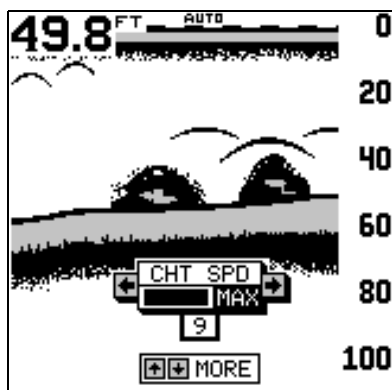

Chart Speed menu.

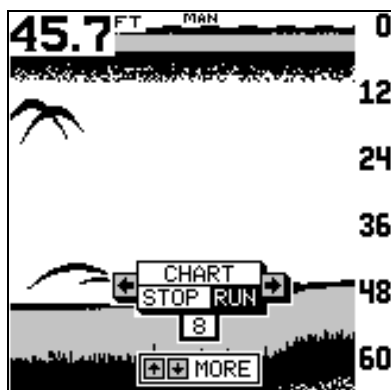

Chart Stop menu.

To stop the chart, press the menu key, then press the up or down arrow keys until the "CHART" menu appears as shown above right. Press the left arrow key to stop the chart. To start the chart again, press the right arrow key.

FISH I.D.TM

The Fish I.D.TM feature identifies targets that meet certain conditions as fish. The microcomputer analyses all echoes and eliminates surface clutter, thermoclines and other signals that are undesirable. In most instances, remaining targets are fish. The Fish I.D. feature displays symbols on the screen in place of the actual fish echoes. There are four fish symbol sizes: tiny, small, medium and large. These are used to designate the relative size between targets. In other words, it displays a small fish symbol when it thinks a target is a small fish, a medium fish symbol on a larger target, etc.

The microcomputer is sophisticated, but it can be fooled. It can't distinguish between fish and other suspended objects such as trotlines, turtles, submerged floats, air bubbles, etc. Individual tree limbs extending outwards from a group of limbs is the hardest object for the Fish I.D. feature to distinguish from fish.

You may see Fish I.D. symbols on the screen when actually, there are no fish. Practice with Fish I.D. turned on and turned off to become more

familiar with the feature.

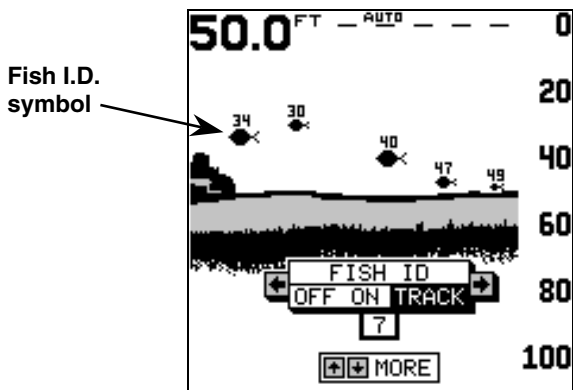

Fish I.D. menu screen.

When the X71 is turned on, the Fish I.D. feature is also turned on automatically. To turn the Fish I.D. feature off, press the menu key, then press the arrow keys until the FISH I.D. menu appears, as shown above. Press the left arrow key to turn the Fish I.D. feature off. To turn the Fish I.D. feature on again, repeat the above steps, but press the right arrow key until the "ON" is highlighted. Any targets the microcomputer determines are fish will be displayed as fish symbols.

Remember, the Fish I.D. feature can't be used when the X71 is in the manual mode. If you turn the Fish I.D. feature on when the X71 is in manual, the microcomputer will turn the automatic feature on. If you turn automatic off when the Fish I.D. feature is on, the Fish I.D. feature will also be turned off.

FISHTRACK™

The FishTrack™ feature shows the depth of a fish symbol when it appears on the display. This lets you accurately gauge the depth of targets. This feature is available only when the Fish I.D. feature is on.

Fish I.D. symbol showing FishTrack depth indicator

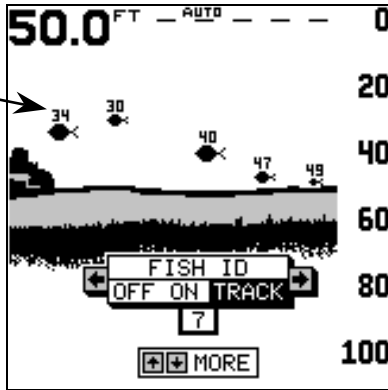

Fish I.D. menu screen, with FishTrack turned on.

When the X71 is turned on, FishTrack is enabled. To turn the FishTrack feature off, press the menu key, then press the up or down arrow keys until the FISH I.D. menu appears. Now press the left arrow key. Pressing it once switches the FishTrack feature off, but leaves Fish I.D. on. To turn FishTrack on, press the right arrow key, which highlights the "TRACK" label on the Fish I.D. menu.

CHART SETUP

The X71 lets you customize the chart screen. To do this, press the **MENU** key, then press the up or down arrow keys until the "CHART SETUP" menu appears. Now press the right arrow key. The screen shown below appears.

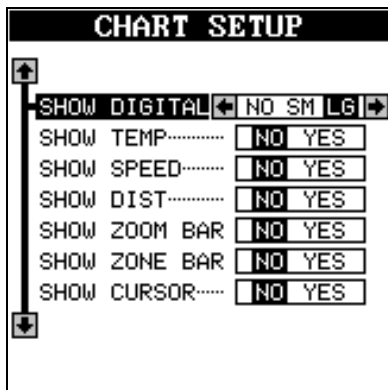

Chart Setup menu screen.

The digital depth display at the top left corner of the screen normally shows in large numbers. You can change this to smaller numbers or turn it off completely using the "Show Digital" menu at the top of this screen.

You can also turn the temperature, speedometer, distance log, zoom bar, zone alarm bar and cursor on or off using this menu. See below for more information on these items.

CHART CURSOR

The X71 has a chart cursor that allows you to pinpoint a target's depth. The cursor is simply a horizontal line that extends across the display from left to right. A depth box at the end of the line on the right side shows the line's depth. In the example below, the cursor (the horizontal line) is at 41.1 feet.

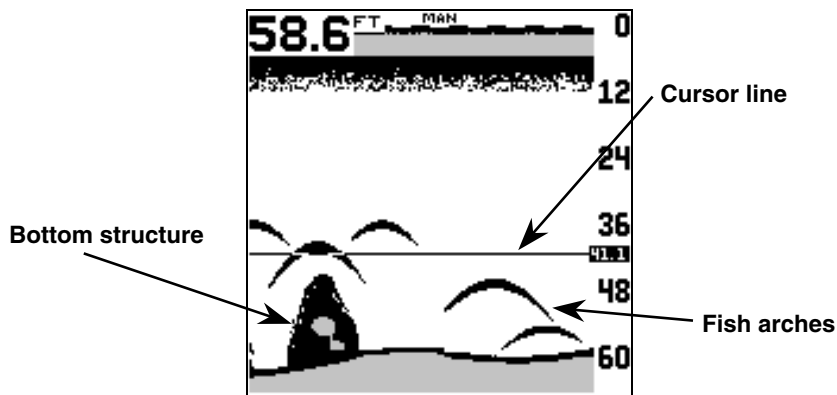

Chart cursor line, showing 41.1 feet.

To display the chart cursor, highlight the "Show Cursor" on the "Chart Setup" menu, then press the right arrow key. A screen similar to the one above appears. Use the up and down arrow keys to move the cursor up or down to the desired depth.

To turn the chart cursor off, repeat the above steps. The X71 returns to the sonar screen without the chart cursor.

DISPLAY ZOOM BAR

When the unit is in the split-screen zoom mode, the zoom bar doesn't normally show on the screen. The zoom bar shows the section of water on the right side of the screen that is being enlarged on the left side. To turn the zoom bar on continuously when the split-screen mode is on, highlight the "Show Zoom Bar" on the "Chart Setup" menu, then press the right arrow key. Now press the **EXIT** key. If you're not in the split-screen mode, change to that mode. A screen similar to the one at the top of page 24 appears. To turn the zoom bar off, repeat the above steps.

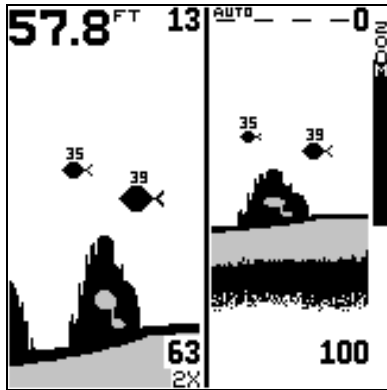

Split-screen zoom bar (right window) shows the portion of the water column being enlarged at left.

DISPLAY ZONE BAR

The zone alarm has a range bar. Any echoes that appear between the top and bottom of this bar trigger the zone alarm. This bar normally doesn't show on the screen. To turn the zone bar on continuously, highlight the "Show Zone Bar" on the "Chart Setup" menu, then press the right arrow key. Now press the **EXIT** key. A screen similar to the one below appears. To turn the zone bar off, repeat the above steps.

See the Alarms section for more information on the zone alarm.

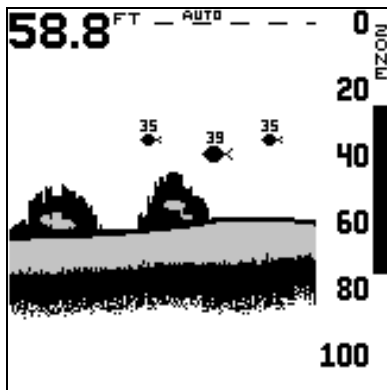

Zone alarm range bar shows the portion of the water column where any echo will trigger the alarm.

DIGITAL SONAR

When the X71 is turned on, the digital depth display is located at the top left corner of the screen. This display comes from a separate digital sonar built into the unit. It displays only the bottom depth. If it loses

the bottom, the last known depth will flash on the display. When the digital sonar finds the bottom, it will automatically display the bottom depth again. The digital sonar can be turned off; however, this also turns off all automatic features, such as auto sensitivity, auto ranging and the Fish I.D. feature.

To turn the digital sonar off, first press the **MENU** key, then press the up or down arrow keys until the "DIGITAL SONAR" menu appears. Press the left arrow key to turn it off.

CAUTION:

Turning the digital sonar off also turns off the automatic mode, including Fish I.D. and the depth alarms.

ALARMS

The X71 has three different types of sonar alarms. The first is the Fish Alarm. It sounds when the Fish I.D. feature determines an echo or group of echoes is a fish. Another alarm is the Zone Alarm which consists of a bar. Any echo that appears inside this bar triggers this alarm. The last alarm is called the Depth Alarm. Only the bottom signal will trigger this alarm. This is useful as an anchor watch, a shallow water alert, or for navigation.

To adjust an alarm, first press the **ALARM** key. The screen shown below appears. Read the following instructions for information on setting each alarm.

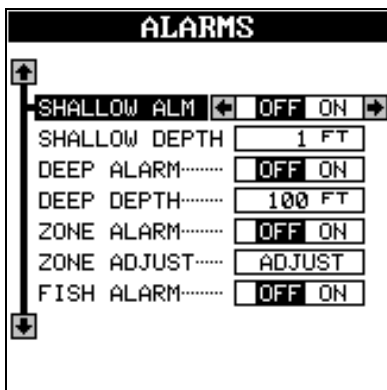

Alarm selection screen.

DEPTH ALARMS

The depth alarms sound a tone when the bottom signal goes shallower than the shallow alarm's setting or deeper than the deep alarm's setting. For example, if you set the shallow alarm to ten feet, the alarm

will sound a tone if the bottom signal is less than ten feet. It will continue to sound until the bottom goes deeper than 10 feet. The deep alarm works just the opposite. It sounds a warning tone if the bottom depth goes deeper than the alarm's setting. Both depth alarms work only off the digital bottom depth signals. No other targets will trip these alarms. If you turn the digital off, the depth alarms will be inoperative. These alarms can be used at the same time or individually.

To adjust the shallow alarm, highlight the "Shallow Depth" label. To adjust the deep alarm, highlight the "Deep Depth" label. Both alarms adjust identically. We'll use the shallow alarm as an example. Highlight the "Shallow Depth" label, then press the right arrow key. The screen shown below appears.

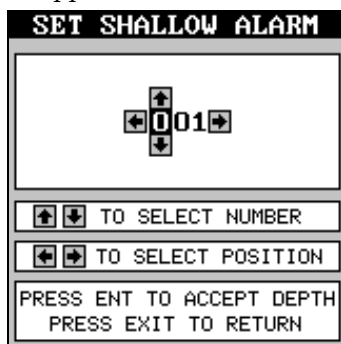

Shallow alarm adjustment screen, set at 1 foot depth.

Use the up or down arrow keys to select the number, the right and left keys to move from number to number in the depth. For example, to set the shallow alarm depth to 10 feet, press the right arrow key once, then press the up arrow key once. This changes the second "0" to a "1". Next, press the right arrow key again and press the down arrow key once. This changes the "1" at the end of the number to a "0" as shown below. The depth now shows 10 feet.

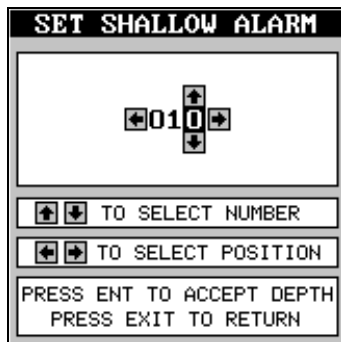

Shallow alarm adjustment screen, reset to 10 foot depth.

Press the **ENT** key to accept this setting. The X71 returns to the alarms menu, showing a shallow depth of 10 feet. Now you can activate the alarm by highlighting the "Shallow Alm" label and pressing the right arrow key.

With the shallow alarm set at 10 feet, any time the digital display goes below ten feet, the shallow alarm sounds.

Set the deep alarm in the same manner. If the bottom depth reading goes below the deep alarm setting, the deep alarm will sound.

ZONE ALARM

The zone alarm is triggered when any echo passes inside the zone alarm bar, shown on the right side of the screen. To turn the zone alarm on, highlight the "Zone Alarm" label on the alarms menu, then press the right arrow key. To adjust the zone alarm, highlight the "Zone Adjust" label, then press the right arrow key. A screen similar to the one below appears.

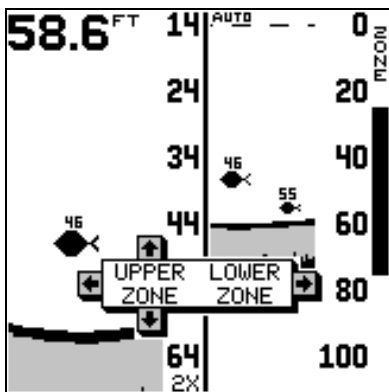

Zone alarm adjustment menu.

To adjust the top of the zone bar higher or lower, press the up or down arrow keys while the up and down arrows are surrounding the "Upper Zone" on the screen as shown above. To adjust the bottom of the zone bar, first press the right arrow key to move the arrows to the "Lower Zone" on the screen, then use the up or down arrow keys.

When the zone alarm is set, press the **EXIT** key to erase the menus.

FISH ALARM

Use the fish alarm for a distinctive audible alarm when fish or other suspended objects are detected by the Fish I.D. feature. A different tone sounds for each fish symbol size shown on the display. To turn the fish alarm on, press the **ALARM** key, then highlight the "Fish Alarm" label

and press the right arrow key. The unit will revert to the sonar display with the fish alarm turned on. Repeat the above steps to turn the fish alarm off.

NOTE:

If the unit is in the manual mode, turning the Fish Alarm on will also turn on the automatic mode and Fish I.D.

ADJUST CHART SURFACE CLARITY

The markings extending downward from the zero line on the chart are called "surface clutter." These markings are caused by wave action, boat wakes, temperature inversion and other natural causes.

The Surface Clarity Control (SCC) reduces or eliminates surface clutter signals from the display. SCC varies the sensitivity of the receiver, decreasing it near the surface and gradually increasing it as the depth increases. The maximum depth that SCC will affect is 75% of the selected depth range. For example, on a 0-60 foot range with maximum SCC, surface clutter will be reduced down to 45 feet.

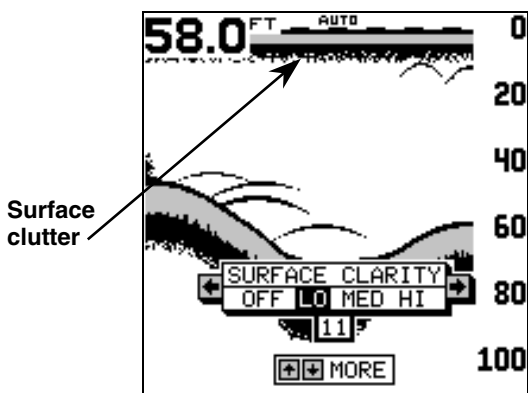

Surface Clarity Control menu.

There are three levels of SCC available on the X71: low, medium and high. When it's turned on for the first time, the SCC level is low. To change it, press the **MENU** key, then press the up or down arrow keys until the "Surface Clarity" menu appears. Now use the left or right arrow keys to change it. When you're finished, press the **EXIT** key to erase the SCC menu.

ASP™ (Advanced Signal Processing)

The ASP feature is a noise rejection system built into the X71 that constantly evaluates the effects of boat speed, water conditions and interference. This automatic feature gives you the best display possible

under most conditions.

The ASP feature is an effective tool in combating noise. In sonar terms, noise is any undesired signal. It is caused by electrical and mechanical sources such as bilge pumps, engine ignition systems and wiring, air bubbles passing over the face of the transducer, even vibration from the engine. In all cases, noise can produce unwanted marks on the display.

The ASP feature has two levels – Normal and High. If you have high noise levels, try using the "High" ASP setting. However, if you are having trouble with noise, we suggest that you take steps to find the interference source and fix it, rather than continually using the unit with the high ASP setting.

There are times when you may want to turn the ASP feature off. This allows you to view all incoming echoes before they are processed by the ASP feature.

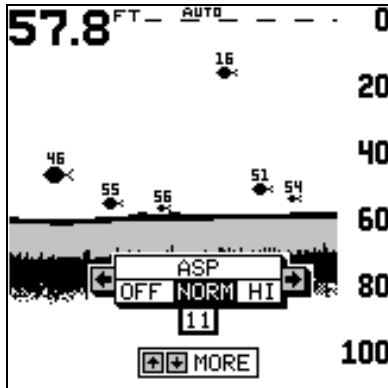

Advanced Signal Processing menu.

To change the ASP level, press the **MENU** key then press the up or down arrow keys until the "ASP" menu appears. Now use the left or right arrow keys to change it. When you're finished, press the **EXIT** key to erase the ASP menu.

SYSTEM SETUP

The following features are available through the "System Setup" menu. To access this menu, press the **MENU** key, then press the up or down arrow keys until the "System Setup" menu appears. Press the right arrow key. The screen shown at the top of page 30 appears.

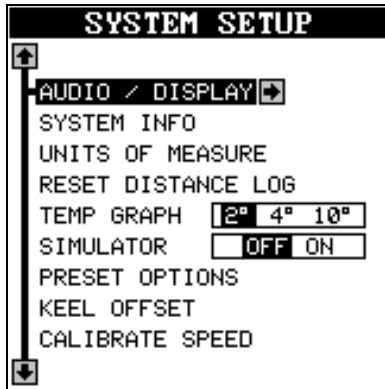

System Setup menu.

Audio/Display

You can adjust the display's contrast and turn the speaker off or on using this menu. To do this, highlight the "Audio/Display" label on the system setup menu, then press the right arrow key. The screen below appears.



Audio/Display menu turns the sound off or on and adjusts screen contrast.

To adjust the contrast, highlight the "Contrast" menu, then use the left or right arrow key to change it. Look at the pattern at the bottom of this screen to adjust it for the best sharpness.

To turn the speaker off, highlight the "Speaker" label, then press the left arrow key to turn it off.

System Information

This screen shows some basic data about the X71. To view this, highlight the "System Info" label on the System Setup menu, then press the right arrow key. The system info screen appears. To erase this screen, press the **EXIT** key. The X71 returns to the System Setup menu.

Units of Measure

The X71 normally shows the depth in feet, speed in statute miles per hour, distance in statute miles and temperature in degrees Fahrenheit. You can change any of these settings using the units of measure menu. To do this, highlight the "Units of Measure" label on the System Setup menu, then press the right arrow key. The screen at right appears. Highlight the item you want to change, then press the right or left arrow key to change it. To erase this screen, press the **EXIT** key.

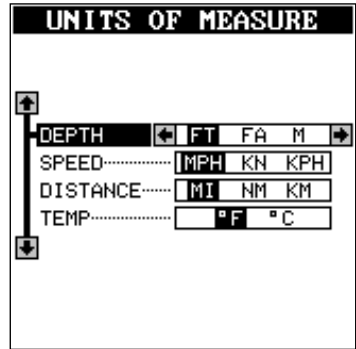

Units of measure selection screen.

Reset Distance Log

If you have a speed sensor attached to the X71, the unit starts counting the distance you've traveled each time you turn it on. You can reset this distance to zero by turning the unit off and on again, however, it's easier to highlight the "Reset Distance Log" label on the System Setup menu, then press the right arrow key. This resets the log and keeps you in the System Setup menu. To erase this menu, press the **EXIT** key.

Temperature Graph

Some of the X71's screens have a temperature graph, as shown at right. Normally, the temperature graph has a 2° range. On the screen at right, the temperature graph has a range from 72° to 74°. You can change this range to 4° or 10° using the "Temp Graph" label on the System Setup menu. Highlight that label, then press the right arrow key until the desired temperature graph range is highlighted. Press the **EXIT** key to erase the menu.

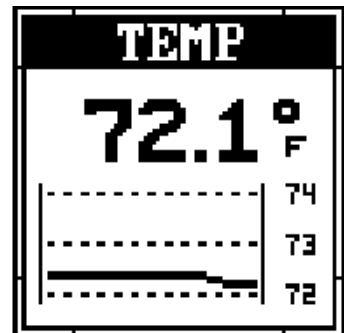

Temperature display shown in the 2° range, from 72° to 74°.

Simulator

The X71 has a simulator built in that lets you use it as if you are on the water. All features and functions of the unit are usable. A message appears occasionally to remind you that the simulator is on.

To use the simulator, press the **MENU** key, then press the up or down arrow keys until the "System Setup" menu appears. When it does, press the right arrow key. Now press the up or down arrow keys until the "Simulator" label is highlighted. Finally, press the right arrow key. The X71 returns to a sonar screen with simulated echoes scrolling across the screen.

Preset Options

The X71 "remembers" all settings such as units of measure, auto/manual and sensitivity, even when power is removed from the unit. To return the X71 to the factory settings, highlight the "Preset Options" label on the "System Setup" menu, then press the right arrow key. The X71 returns to the full chart screen with all settings returned to their factory values.



The Preset Options command on the System Setup menu restores all factory settings.

Keel Offset

The X71 measures water depth from the face of the transducer. Since the transducer is below the surface of the water, this distance is not the exact water depth. If the transducer is one foot below the surface, and the X71 reports the water depth as 30 feet, then the depth is actually 31 feet.

You can calibrate the depth reading using the keel offset feature. First, highlight the "Keel Offset" label on the "System Setup" menu, then press the right arrow key. The screen shown at the top of page 33 appears.

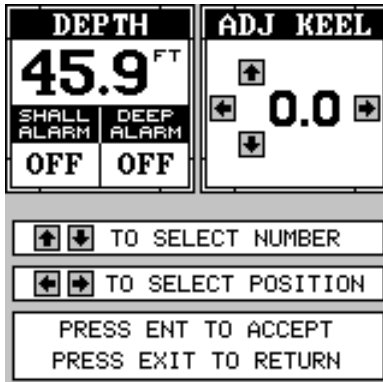

Keel Offset adjustment screen, set to zero.

The current bottom depth shows in the upper left corner of the screen. The keel offset shows in the upper right corner. In this example, we need to change the keel offset so that the X71 will add one foot to the depth, since the transducer is one foot below the surface. Press the right arrow key, then the up or down arrow keys until 1.0 appears in the "Adj Keel" box, as shown below, then press the **ENT** key. This immediately changes the digital depth display at the top of the screen by one foot. Press the **EXIT** key to erase this menu.

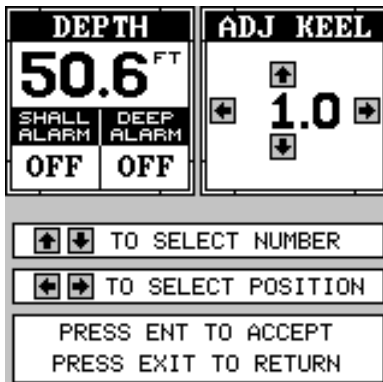

Keel Offset adjustment screen, set to one foot. Note how the digital depth display changed by one foot.

NOTE:

Another way to use the keel offset feature is if you want to know the depth of the water below the lowest part of the boat, instead of the surface. To do this, measure the lowest part of the boat below the transducer. In this example, we'll use 3 feet. Now, using the keel offset feature, adjust the offset for a *negative* 3 feet, as shown on page 34.

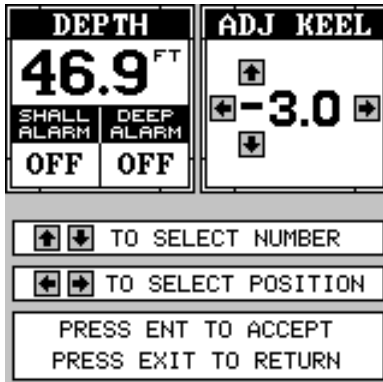

Use the Keel Offset adjustment to figure water depth below the keel.

Please note that adjusting the keel offset only affects the digital depth display and all features that use the digital depth, such as the depth alarms and FishTrack. This doesn't affect the chart at all.

Calibrate Speed

You can calibrate the speed display if an optional speed sensor is attached to the X71. To do this, highlight the "Calibrate Speed" label on the "System Setup" menu, then press the right arrow key. A screen similar to the one below appears.

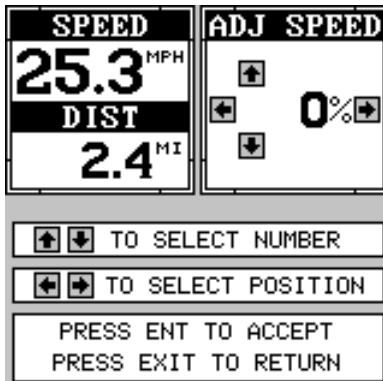

Calibrate Speed adjustment screen.

If the digital speed display is slower than your actual speed, add a positive percentage to make it read faster. If the digital speed display is faster, use a negative percentage to make it read slower. Use the arrow keys to change the speed, then press the **ENT** key. Press the **EXIT** key to erase this menu.

Windows Summary

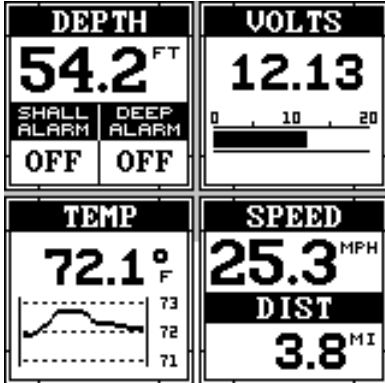

Window Group A

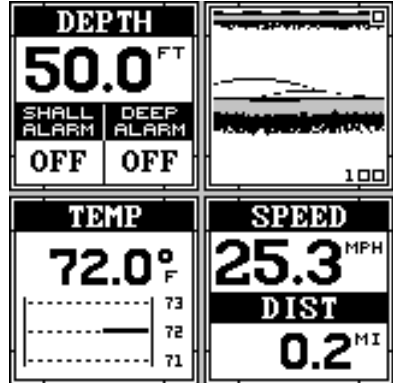

Window Group B

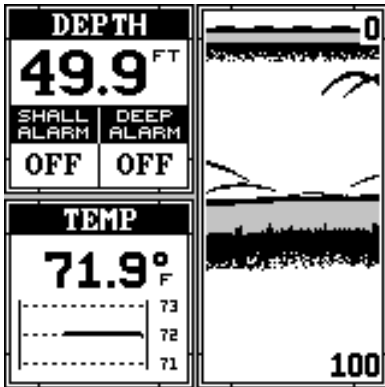

Window Group C

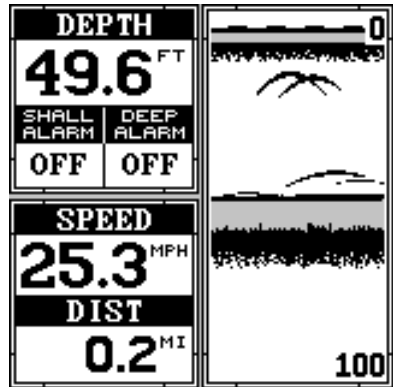

Window Group D

Notes

Troubleshooting

If your unit is not working, or if you need technical help, please use the following troubleshooting section before contacting the factory customer service department. It may save you the trouble of returning your unit.

Unit won't turn on:

1. Check the power cable's connection at the unit. Also check the wiring.
2. Make certain the power cable is wired properly. The red wire connects to the positive battery terminal, black to negative or ground.
3. Check the fuse.
4. Measure the battery voltage at the unit's power connector. It should be at least 11 volts. If it isn't, the wiring to the unit is defective, the battery terminals or wiring on the terminals are corroded, or the battery needs charging.

Unit freezes, locks up, or operates erratically:

1. Electrical noise from the boat's motor, trolling motor, or an accessory may be interfering with the sonar unit. Rerouting the power and transducer cables away from other electrical wiring on the boat may help. Route the sonar unit's power cable directly to the battery instead of through a fuse block or ignition switch
2. Inspect the transducer cable for breaks, cuts, or pinched wires.
3. Check both the transducer and power connectors. Make certain both are securely plugged in to the unit.

Weak bottom echo, digital readings erratic, or no fish signals:

1. Make certain the transducer is pointing straight down. Clean the face of the transducer. Oil, dirt and fuel can cause a film to form on the transducer, reducing its effectiveness. If the transducer is mounted inside the hull, be sure it is shooting through only one layer of fiberglass and that it is securely bonded to the hull. Do NOT use RTV silicone rubber adhesive or Marinetex
2. Electrical noise from the boat's motor can interfere with the sonar. This causes the sonar to automatically increase its Discrimination or noise rejection feature. This can cause the unit to eliminate weaker signals such as fish or even structure from the display.
3. The water may be deeper than the sonar's ability to find the bottom. If the sonar can't find the bottom signal while it's in the automatic

mode, the digital sonar display will flash continuously. It may change the range to limits far greater than the water you are in. If this happens, place the unit in the manual mode, then change the range to a realistic one, (for example, 0-100 feet) and increase the sensitivity. As you move into shallower water, a bottom signal should appear.

4. Check the battery voltage. If the voltage drops, the unit's transmitter power also drops, reducing its ability to find the bottom or targets.

Bottom echo disappears at high speeds or erratic digital reading or weak bottom echo while boat is moving

1. The transducer may be in turbulent water. It must be mounted in a smooth flow of water in order for the sonar to work at all boat speeds. Air bubbles in the water disrupt the sonar signals, interfering with its ability to find the bottom or other targets. The technical term for this is cavitation.

2. Electrical noise from the boat's motor can interfere with the sonar. This causes the sonar to automatically increase its Discrimination or noise rejection feature. This can cause the unit to eliminate weaker signals such as fish or even structure from the display. Try using resistor spark plugs or routing the sonar unit's power and transducer cables away from other electrical wiring on the boat.

No fish arches when the Fish I.D. feature is off:

1. Make certain the transducer is pointing straight down. This is the most common problem if a partial arch is displayed.

2. The sensitivity may not be high enough. In order for the unit to display a fish arch, it has to be able to receive the fish's echo from the time it enters the cone until it leaves. If the sensitivity is not high enough, the unit shows the fish only when it is in the center of the cone.

3. Use the Zoom feature. It is much easier to display fish arches when zoomed in on a small range of water than a large one. For example, you will have much better luck seeing fish arches with a 30 to 60 foot range than a 0 to 60 foot range. This enlarges the targets, allowing the display to show much more detail.

4. The boat must be moving at a slow trolling speed to see fish arches. If the boat is motionless, fish stay in the cone, showing on the screen as straight horizontal lines.

NOISE

A major cause of sonar problems is electrical noise. This usually appears on the sonar's display as random patterns of dots or lines. In severe cases, it can completely cover the screen with black dots, or

cause the unit operate erratically, or not at all.

To eliminate or minimize the effects of electrical noise, first try to determine the cause. With the boat at rest in the water, the first thing you should do is turn all electrical equipment on the boat off. Make certain the engine is off, also. Turn your X71 on, then turn off ASP (Advanced Signal Processing). There should be a steady bottom signal on the display. Now turn on each piece of electrical equipment on the boat and view the effect on the sonar's display. For example, turn on the bilge pump and view the sonar display for noise. If no noise is present, turn the pump off, then turn on the VHF radio and transmit. Keep doing this until all electrical equipment has been turned on, their effect on the sonar display noted, then turned off.

If you find noise interference from an electrical instrument, trolling motor, pump, or radio, try to isolate the problem. You can usually reroute the sonar unit's power cable and transducer cable away from the wiring that is causing the interference. VHF radio antenna cables radiate noise when transmitting, so be certain to keep the sonar's wires away from it. You may need to route the sonar unit's power cable directly to the battery to isolate it from other wiring on the boat.

If no noise displays on the sonar unit from electrical equipment, then make certain everything except the sonar unit is turned off, then start the engine. Increase the RPM with the gearshift in neutral. If noise appears on the display, the problem could be one of three things; spark plugs, alternator, or tachometer wiring. Try using resistor spark plugs, alternator filters, or routing the sonar unit's power cable away from engine wiring. Again, routing the power cable directly to the battery helps eliminate noise problems. Make certain to use the in-line fuse supplied with the unit when wiring the power cable to the battery.

When no noise appears on the sonar unit after all of the above tests, then the noise source is probably cavitation. Many novices or persons with limited experience make hasty sonar installations which function perfectly in shallow water, or when the boat is at rest. In nearly all cases, the cause of the malfunction will be the location and/or angle of the transducer. The face of the transducer must be placed in a location that has a smooth flow of water at all boat speeds. Read your transducer owner's manual for the best mounting position.

Notes

LOWRANCE ELECTRONICS FULL ONE-YEAR WARRANTY

"We," "our," or "us" refers to LOWRANCE ELECTRONICS, INC., the manufacturer of this product. "You" or "your" refers to the first person who purchases this product as a consumer item for personal, family or household use.

We warrant this product against defects or malfunctions in materials and workmanship, and against failure to conform to this product's written specifications, all for one (1) year from the date of original purchase by you. **WE MAKE NO OTHER EXPRESS WARRANTY OR REPRESENTATION OF ANY KIND WHATSOEVER CONCERNING THIS PRODUCT.** Your remedies under this warranty will be available so long as you can show in a reasonable manner that any defect or malfunction in materials or workmanship, or any non-conformity with the product's written specifications, occurred within one year from the date of your original purchase, which must be substantiated by a dated sales receipt or sales slip. Any such defect, malfunction, or non-conformity which occurs within one year from your original purchase date will either be repaired without charge or be replaced with a new product identical or reasonably equivalent to this product, at our option, within a reasonable time after our receipt of the product. If such defect, malfunction, or non-conformity remains after a reasonable number of attempts to repair by us, you may elect to obtain without charge a replacement of the product or a refund for the product. **THIS REPAIR, OR REPLACEMENT OR REFUND (AS JUST DESCRIBED) IS THE EXCLUSIVE REMEDY AVAILABLE TO YOU AGAINST US FOR ANY DEFECT, MALFUNCTION, OR NON-CONFORMITY CONCERNING THE PRODUCT OR FOR ANY LOSS OR DAMAGE RESULTING FROM ANY OTHER CAUSE WHATSOEVER. WE WILL NOT UNDER ANY CIRCUMSTANCES BE LIABLE TO ANYONE FOR ANY SPECIAL, CONSEQUENTIAL, INCIDENTAL, OR OTHER INDIRECT DAMAGE OF ANY KIND.**

Some states do not allow the exclusion or limitation of incidental or consequential damages, so the above limitations or exclusions may not apply to you.

This warranty does NOT apply in the following circumstances: (1) when the product has been serviced or repaired by anyone other than us; (2) when the product has been connected, installed, combined, altered, adjusted, or handled in a manner other than according to the instructions furnished with the product; (3) when any serial number has been effaced, altered, or removed; or (4) when any defect, problem, loss, or damage has resulted from any accident, misuse, negligence, or carelessness, or from any failure to provide reasonable and necessary maintenance in accordance with the instructions of the owner's manual for the product.

We reserve the right to make changes or improvements in our products from time to time without incurring the obligation to install such improvements or changes on equipment or items previously manufactured.

This warranty gives you specific legal rights and you may also have other rights which may vary from state to state.

REMINDER: You must retain the sales slip or sales receipt proving the date of your original purchase in case warranty service is ever required.

**LOWRANCE ELECTRONICS
12000 E. SKELLY DRIVE, TULSA, OK 74128
(800) 324-1356**

How to Obtain Service...

...in the USA:

We back your investment in quality products with quick, expert service and genuine Lowrance parts. If you're in the United States and you have technical, return or repair questions, please contact the Factory Customer Service Department. Before any product can be returned, you must call customer service to determine if a return is necessary. Many times, customer service can resolve your problem over the phone without sending your product to the factory. To call us, use the following toll-free number:

800-324-1356

8 a.m. to 5 p.m. Central Standard Time, M-F

Lowrance Electronics may find it necessary to change or end our shipping policies, regulations, and special offers at any time. We reserve the right to do so without notice.

...in Canada:

If you're in Canada and you have technical, return or repair questions, please contact the Factory Customer Service Department. Before any product can be returned, you must call customer service to determine if a return is necessary. Many times, customer service can resolve your problem over the phone without sending your product to the factory. To call us, use the following toll-free number:

800-661-3983

905-629-1614 (not toll-free)

8 a.m. to 5 p.m. Central Standard Time, M-F

...outside Canada and the USA:

If you have technical, return or repair questions, contact the dealer in the country where you purchased your unit. To locate a dealer near you, visit our web site, www.lowrance.com and click on Support and then click Dealer Locator.

Accessory Ordering Information for all countries

To order Lowrance accessories such as power cables or transducers, please contact:

1) Your local marine dealer or consumer electronics store. Most quality dealers that handle marine electronic equipment or other consumer electronics should be able to assist you with these items.

To locate a Lowrance dealer near you, visit our web site, www.lowrance.com and click on Support and then click Dealer Locator. Or, you can consult your telephone directory for listings.

2) U.S. customers: LEI Extras Inc., PO Box 129, Catoosa, OK 74015-0129
Call 1-800-324-0045 or visit our web site www.lei-extras.com.

3) Canadian customers can write:

Lowrance/Eagle Canada, 919 Matheson Blvd. E. Mississauga, Ontario L4W2R7 or fax 905-629-3118.

Shipping Information

If it becomes necessary to send a product for repair or replacement, you must first receive a return authorization number from Customer Service. Products shipped without a return authorization will not be accepted. When shipping, we recommend you do the following:

1. Always use the original shipping container and filler material the product was packed in.
2. Always insure the parcel against damage or loss during shipment. Lowrance does not assume responsibility for goods lost or damaged in transit.
3. For proper testing, include a brief note with the product describing the problem. Be sure to include your name, return shipping address and a daytime telephone number.

Visit our web site:



L[®] LOWRANCE

We Lead, We Find, You Win.[™]

Lowrance Pub. 988-0133-65

Printed in USA 101001

© Copyright 2001
All Rights Reserved
Lowrance Electronics, Inc.

Free Manuals Download Website

<http://myh66.com>

<http://usermanuals.us>

<http://www.somanuals.com>

<http://www.4manuals.cc>

<http://www.manual-lib.com>

<http://www.404manual.com>

<http://www.luxmanual.com>

<http://aubethermostatmanual.com>

Golf course search by state

<http://golfingnear.com>

Email search by domain

<http://emailbydomain.com>

Auto manuals search

<http://auto.somanuals.com>

TV manuals search

<http://tv.somanuals.com>