



# **CALLMASTER® V Telephone Console User's Guide**

<b>The CALLMASTER V Telephone Console . . . . .</b>	<b>1</b>
<b>Headset Connections with the CALLMASTER V . . . . .</b>	<b>2</b>
<b>Compatible Headpieces . . . . .</b>	<b>3</b>
<b>The CALLMASTER V Recorder Interface . . . . .</b>	<b>3</b>
<b>The Softkeys . . . . .</b>	<b>3</b>
<b>Using the Softkey Feature Menus . . . . .</b>	<b>4</b>
<b>Other Softkey Features That May Be On Your Display . 4</b>	<b>4</b>
<b>Call-Handling Features . . . . .</b>	<b>4</b>
<b>Getting Messages . . . . .</b>	<b>7</b>
<b>Selecting a Personalized Ring . . . . .</b>	<b>8</b>
<b>Voice and Display Features . . . . .</b>	<b>8</b>
<b>Operating Range Requirements . . . . .</b>	<b>9</b>
<b>Telephone Installation . . . . .</b>	<b>9</b>
<b>Important Safety Warnings for Installation . . . . .</b>	<b>10</b>
<b>Desktop Installation . . . . .</b>	<b>11</b>
<b>Wall Installation . . . . .</b>	<b>12</b>
<b>Installing the Designation Card . . . . .</b>	<b>13</b>
<b>Orderable Cards and Equipment . . . . .</b>	<b>14</b>

555-233-735  
Comcode 108488222  
Issue 1  
September 1999

## NOTICE

While reasonable efforts were made to ensure that the information in this document was complete and accurate at the time of printing, Lucent Technologies can assume no responsibility for any errors. Changes or corrections to the information contained in this document may be incorporated into future issues.

## TO ORDER COPIES OF THIS DOCUMENT

**Contact:** Lucent Technologies BCS Publications Center  
2855 N. Franklin Road  
Indianapolis, IN 46219  
Domestic: 1 800 457-1235      International: 1 317 322-6791  
Domestic Fax: 1 800 457-1764      International Fax: 1 317 322-6699

**Order:** Document No. 555-233-735  
Issue 1, September 1999

## HEARING AID COMPATIBILITY

The CALLMASTER V telephone console is Hearing Aid Compatible (HAC) when used with HAC headsets, and thus all units have "HAC" printed on them.

## YOUR RESPONSIBILITY FOR YOUR SYSTEM'S SECURITY

You are responsible for the security of your system. Lucent Technologies does not warrant that this product is immune from or will prevent unauthorized use of common-carrier telecommunication services or facilities accessed through or connected to it. Lucent Technologies will not be responsible for any charges that result from such unauthorized use. Product administration to prevent unauthorized use is your responsibility and your system manager should read all documents provided with this product to fully understand the features available that may reduce your risk of incurring charges.

## TRADEMARKS

DEFINITY, AUDIX, and CALLMASTER are registered trademarks of Lucent Technologies.

Mirage, Star Set, and Supra are registered trademarks of Plantronics, Inc.

## FCC REGULATIONS

The FCC requires us to provide the following warning for Class B residential installations.

**WARNING:** This equipment has been tested and found to comply with the limits for a **Class B** digital device, pursuant to Part 15 of the FCC Rules. These limits are designed to provide reasonable protection against harmful interference in a residential installation. This equipment generates, uses, and can radiate radio frequency energy and, if not installed and used in accordance with the instructions, may cause harmful interference to radio and television communications. However, there is no guarantee that interference will not occur in a particular installation. If this equipment does cause harmful interference to radio or television reception, which can be determined by turning the equipment off and on, the user is encouraged to try to correct the interference by one or more of the following measures:

- Reorient or relocate the receiving antennae.
- Increase the separation between the equipment and receiver.
- Connect the equipment into an outlet on a circuit different from that to which the receiver is connected.
- Consult the dealer or an experienced radio/tv technician for help.

## OBTAINING PRODUCTS

To learn more about Lucent Technologies products and to order any of these products, contact Lucent Direct, the direct-market organization of Lucent Technologies Business Communications System. Access their web site at [www.lucentdirect.com](http://www.lucentdirect.com) or call the following numbers: customers should call 1 800 451-2100 or account executives can contact Lucent Direct at 1 800 778 1880 (voice) or 1 800 778-1881 (fax).

## THE "CE" MARK

If the "CE" mark is affixed to this equipment, it means that it conforms to the European Union Electromagnetic Compatibility Directive (89/336/EEC) and the Low Voltage Directive (73/23/EEC).

Prepared by  
BCS Product Publications  
Middletown, New Jersey 07748-1998

© 1999 Lucent Technologies  
All Rights Reserved  
Printed in USA

# IMPORTANT USER SAFETY INSTRUCTIONS

The most careful attention has been devoted to quality standards in the manufacture of your new telephone. Safety is a major factor in the design of every set. But, safety is YOUR responsibility too.

Please read carefully the helpful tips listed below and on the next page. These suggestions will enable you to take full advantage of your new voice terminal. Then, retain these tips for later use.



### CAUTION:

*This telephone is NOT for residential use. It is for business systems applications ONLY. It will NOT operate on public networks. It MUST BE connected to a DEFINITY Enterprise Communications Server. Use in a residential environment could result in an electrical short circuit when the telephone wiring is set up to provide other applications, for example, for appliance control or power transformers. The AC power used in these applications may create a safety hazard by placing a direct short circuit across the telephone wiring.*

### Use

When using your telephone equipment, the following safety precautions should always be followed to reduce the risk of fire, electric shock, and injury to persons.

- Read and understand all instructions.
- Follow all warnings and instructions marked on the telephone.

- This telephone can be hazardous if immersed in water. To avoid the possibility of electric shock, do not use it while you are wet. If you accidentally drop the telephone into water, do not retrieve it until you have first unplugged the line cord from the modular wall jack. Then, call service personnel to ask about a replacement.
- Avoid using the telephone during electrical storms in your immediate area. There is a risk of electric shock from lightning. Urgent calls should be brief. Even though protective measures may have been installed to limit electrical surges from entering your business, absolute protection from lightning is impossible.
- If you suspect a natural gas leak, report it immediately, but use a telephone away from the area in question. The telephone's electrical contacts could generate a tiny spark. While unlikely, it is possible that this spark could ignite heavy concentrations of gas.
- Never push objects of any kind into the equipment through housing slots since they may touch hazardous voltage points or short out parts that could result in a risk of electric shock. Never spill liquid of any kind on the telephone. If liquid is spilled, however, refer servicing to proper service personnel.
- To reduce the risk of electric shock, do not disassemble this telephone. There are no user serviceable parts. Opening or removing covers may expose you to hazardous voltages. Incorrect reassembly can cause electric shock when the telephone is subsequently used.

### Service

1. Before cleaning, unplug the telephone from the modular wall jack. Do not use liquid cleaners or aerosol cleaners. Use a damp cloth for cleaning.
2. Unplug the telephone from the modular wall jack. Be sure to refer servicing to qualified service personnel when these conditions exist:
  - If liquid has been spilled into the telephone.
  - If the telephone has been exposed to rain or water.
  - If the telephone has been dropped or the housing has been damaged.
  - If you note a distinct change in the performance of the telephone.

## SAVE THESE INSTRUCTIONS



When you see this warning symbol on the product, refer to this instructions booklet packed with the product for more information before proceeding.

# The CALLMASTER V Telephone Console

The CALLMASTER® V telephone has been specially designed for use with the Automatic Call Distribution (ACD) system and the many features of the DEFINITY® Enterprise Communications Server (ECS) and the DEFINITY® Communications System Generic 1, Generic 2, and Generic 3. **This telephone is designed to be used with a headset in a 2-wire environment.**

**Note:** Power for the CALLMASTER V telephone, including the headset, comes from the DEFINITY switch through the 2-wire DCP line.

The CALLMASTER V also has a built-in Recorder Interface which allows you to connect the telephone to a recording device so that you can record all voice interactions. For more information about this interface, see "The CALLMASTER V Recorder Interface" on page 3.

**Note:** The tape recorder used with the CALLMASTER V telephone must be purchased by the user; it is *not* provided with the telephone.





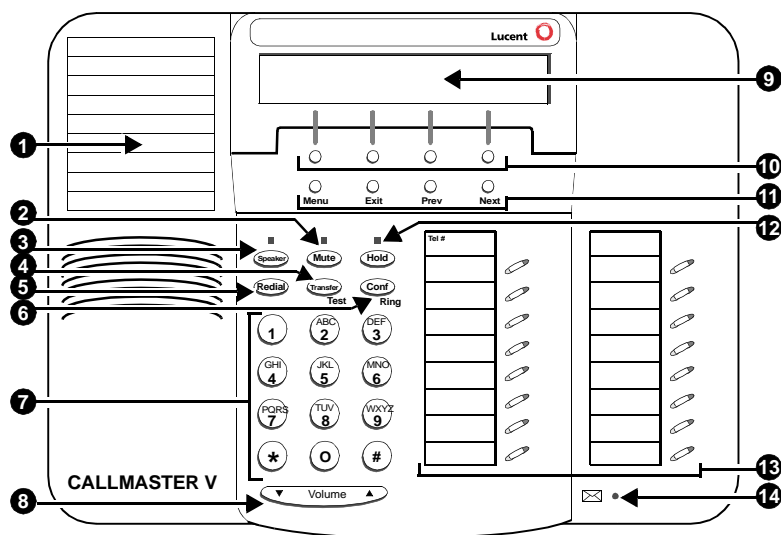

Figure 1 below shows a front view of the CALLMASTER V telephone. The features of the telephone are explained after the figure.

**Note:** For a rear view of the telephone, see Figure 4 on page 9.



**FIGURE 1** The CALLMASTER V Telephone Console, Front View

The following features correspond to the numbers in Figure 1.

1) Telephone Notepad	8) Volume control button
2) Mute (or  ) button	9) Display
3) Speaker (or  ) button	10) Softkeys
4) Transfer/Test (or  ) button	11) Display control buttons
5) Redial (or  ) button	12) Hold (or  ) button
6) Conf/Ring (or  ) button	13) Call appearance/feature buttons (See <b>Note</b> immediately below)
7) Dial pad	14) Message light — labeled 

**Note:** Two feature buttons must be administered in the following ways:

- One of the feature buttons must be designated as the **Headset On/Off button**;
- The **Release feature** must be administered on a second feature button.

## Headset Connections with the CALLMASTER V

The headset connection for the CALLMASTER V consists of a headpiece (shown as **1** in Figure 2 below) which is plugged into an adapter cord (shown as **2**).

**Note:** Your system manager **MUST** administer a **Headset On/Off** button on your set. Use this button to turn your headset on and off. For instructions for using this feature button, see "Headset On/Off" in the section titled **Call-Handling Features**.

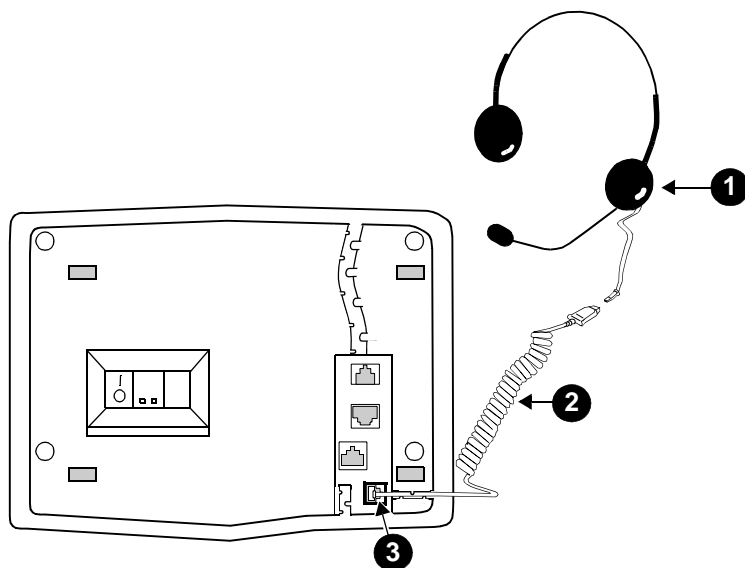

**FIGURE 2** The Headset Connected to One of the Headset Jacks (shown as **3**) on the CALLMASTER V Telephone

## Compatible Headpieces

The following Lucent Technologies headpieces can be used with these telephones:

- **Mirage®** — Receiver fits over either ear. Not for noisy environments.
- **StarSet®** — Eartip fits in ear canal.
- **Supra®** — Adjustable headband and soft ear cushion.
- **Encore®** — Advanced sound technology with adjustable headband and soft ear cushion.
- **TriStar®** — Advanced headpiece which fits over the ear.

## The CALLMASTER V Recorder Interface

The CALLMASTER V's Recorder Interface is designed for recording calls on a standard tape recorder. (A recorder with AGC [Automatic Gain Control] is recommended.) With this interface, a warning tone, a soft beep repeated every 13.5 seconds, notifies the agent and the calling party that the call is being recorded. *Be aware that this tone may be a legal requirement.*

**IMPORTANT:** The use of service observing features and call recording features may be subject to federal, state, and local laws, rules, or regulations and may be prohibited pursuant to the laws, rules, or regulations or require the consent of one or both of the parties to the conversation. Customers should familiarize themselves with and comply with all applicable laws, rules, and regulations before using these features.

## The Softkeys

The softkeys are the four unlabeled round keys located directly below the display. The four round display control buttons, labeled **Menu**, **Exit**, **Prev**, and **Next** are located under the softkeys. See Figure 3.

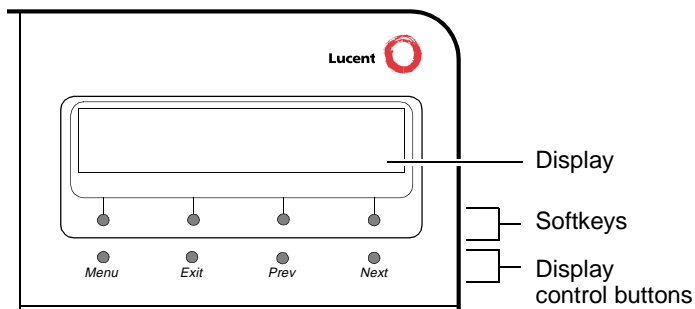
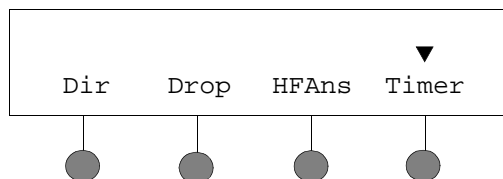

**FIGURE 3** The Display, Softkeys, and Display Control Buttons

### Using the Softkey Feature Menus

There are three separate softkey feature menus. Each of these menus allows you to select from four different features.

You can enter Softkey Mode (and view the softkey feature menu) by pressing the display control button labeled **Menu** or . The following is an example of a softkey feature menu.



The **top line** of each softkey feature menu screen shows you the status of each of the four features. An arrow appears above the feature name or abbreviation if that feature is active. In the above example, the arrow above the Timer feature indicates that feature is active.

The **second line** on each softkey feature menu shows the features you can access. To use any of these features, you must press the softkey below the feature name or abbreviation.

Press the **Next** or **Prev** button until the feature you want to use appears on the display.

**Note:** An error tone (one beep) sounds when you have made an inappropriate softkey entry.

Press the **Exit** button at any time to exit the softkey feature menus and return to normal call-handling operation.

### Other Softkey Features That May Be On Your Display

There are 12 default features that can be accessed with the softkeys on a CALLMASTER V telephone. However, the system manager may substitute other softkey features in their place.

## Call-Handling Features

### HEADSET ON/OFF

The system administrator should have administered a  button on your CALLMASTER V telephone.

#### To turn on your headset

1. Press .

*The green light next to the button goes on to remind you the headset is active.*

#### To turn off your headset

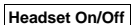
1. Press  again.







*The green light next to the button goes off.*





## CONFERENCE

The Conference feature allows you to conference up to six parties (including yourself) on a call.

### **To add another party to a call (for a total of six parties)**

1. Press  (or ). *[dial tone]*
2. Dial the number of the new party and wait for an answer.
3. When you want to add the new person, press  (or ) again.
4. Repeat Steps 1 through 3 for additional conference connections.

### **To add a call you have put on hold to another call you are connected to**

1. Press  (or ). *[dial tone]*
2. Press the call appearance button of the call on hold (first call).
3. Press  (or ) again.

### **To drop the last person added to the conference call**



1. **With a display:** Press the **Menu** button and then press the softkey below **Drop**.

**Without a display:** Press the  button (if administered).



## HOLD

The Hold feature puts a call on hold until you can return to it.

### **To put a call on hold while you answer another call or perform another task**

1. Press  (or ).

### **To answer a new call while active on another**

1. Press  (or ).
2. Press the call appearance button of the incoming call.

### **To return to the held call**

1. Press the call appearance button of the held call.

## REDIAL

The Redial (or Last Number Dialed) feature automatically redials the last extension or outside number (up to 24 digits) you dialed.

### **To redial the last number that you dialed**

1. Press  (or ).

## RELEASE

An ACD agent can press **Release** to disconnect from a call.

### To disconnect from a call

1. Press **Release**.



**Note:** Pressing **Release** is faster than waiting for a caller or trunk to disconnect and enables you to perform other ACD or voice terminal procedures sooner. You *do not* hear dial tone after you press **Release**.

If you want to disconnect from a call and then place another call, you can press **Drop** instead.

## SPEAKER (LISTEN-ONLY) and GROUP LISTEN

The Speaker feature allows you to place calls or access other features without using the headset. However, in order to speak to the other party, you must use the headset. With the Group Listen feature, the headset and speaker are active at the same time.

### To use the listen-only speaker to place a call without using the headset or for any listening-only feature (such as monitoring a call on which you have been put on hold or for group listening)

1. Press **Spkr** (or .
2. Place a call or access the selected feature.
3. Adjust speaker volume if necessary:  
To raise the volume, press the right half of the Speaker Volume control button labeled ; to lower the volume, press the left half of the Speaker Volume control button labeled .

The display shows the volume level: (There are eight volume levels.)

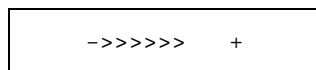

### To end a call (while the headset is off and only the speaker is active)

1. Press **Spkr** (or .

### To activate the speaker while using the headset so that both are active at the same time (the Group Listen feature)

1. While you are using the headset, activate the speaker by pressing **Spkr** (or .

### To turn off the speaker and return to headset use

1. Press **Spkr** (or .

## TEST

The Test feature allows you to test the lights and display on your telephone.

### To test the lights and display on your telephone

1. With the headset off, press and hold down **Trnsfr** (or ) .

*Lights go on in columns, and all the display segments fill in.*

2. To end test, release **Trnsfr** (or ) .



*Lights return to normal operation.*

**Note:** If the lights or the display segments do not respond during the test, see your system manager.

## TRANSFER

The Transfer feature allows you to transfer a call from your telephone to another extension or outside number.

### To send the present call to another extension

1. While on a call, press **Trnsfr** (or ) . [dial tone]
2. Dial the number to which the call is to be transferred. [ringing tone]
3. Remain on the line and announce the call.  
(If the line is busy or if there is no answer, you can return to the held call by pressing its call appearance button.)
4. Press **Trnsfr** (or ) again to complete the transfer.

**Note:** To cancel an attempted transfer, press the original call appearance. If your system has auto-hold activated, use **Drop** to cancel a transfer so that the potential transfer recipient is not left on hold.

# Getting Messages

## MESSAGE

Your Message light goes on when a caller has left a message for you.

**Note:** You may also be able to use the Message Retrieval display feature.

For directions on retrieving your messages, see your system manager.

# Selecting a Personalized Ring

## SELECT RING

The Select Ring feature allows you to choose your own personalized ringing pattern for your telephone from among eight different patterns.

### To select a personalized ringing pattern

1. With the headset off, press **Conf** (or **CCC**).

*Current ringing pattern plays and repeats every three seconds.*

2. Continue to press (and then release) **Conf** (or **CCC**) to cycle through all eight ringing patterns.
3. If you want to save the ringing pattern currently being played, do not press **Conf** (or **CCC**) anymore. You will hear the selected ringing pattern two more times, and then it will be automatically saved.

*You will hear a confirmation tone (two rising tones), and your new ringing pattern is set.*

**Note:** If you turn on the headset, receive a call, or lose power during selection, the process is canceled and you must start again.

## Voice and Display Features

For directions on using the voice features on your telephone such as Abbreviated Dialing, Call Forwarding, and Send All Calls, see the section titled **Basic Voice Terminal Procedures** in either of two user's guides:

- *DEFINITY® Enterprise Communications Server Generic 1, Generic 3, and System 75 Automatic Call Distribution (ACD) Agent Instructions, 555-230-722*
- *DEFINITY® Enterprise Communications Server Generic 1, Generic 3, and System 75 Automatic Call Distribution (ACD) Supervisor Instructions, 555-230-724*

You can order both of these books from the Lucent Technologies BCS Publications Center by calling 1 800 457-1235 (within the United States) or 1 317 322-6791 (outside the United States).

## Operating Range Requirements

The total distance between the CALLMASTER V telephone (with Recorder Interface active) and the recording device should not exceed 200 feet/ 60.96 meters.

The distance between the CALLMASTER V telephone and the PBX must NOT exceed the following:

With 22-gauge wire, the distance between the CALMASTER V and the PBX should not exceed 5,500 feet/ 1,676.4 meters; with 24-gauge wire, the distance should not exceed 3,500 feet/ 1,066.8 meters; with 26-gauge wire, the distance should not exceed 2,200 feet/ 670.56 meters.

The record output impedance is approximately 600 ohms and the output channel is isolated from the telephone via a voice transformer that meets the UL 1950 Dielectric Breakdown requirement of 1,000 URMS for one minute.

## Telephone Installation

The CALLMASTER V telephone can be either desk-mounted or wall-mounted. Read the following safety instructions and use the following directions and refer to the following figure of the rear of the telephone for installing these telephones.

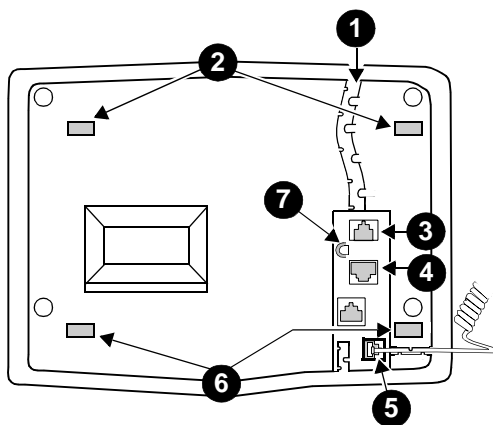

**FIGURE 4** The CALLMASTER V Telephone Console, Rear View

## Important Safety Warnings for Installation

When this product is located in a separate building from the telephone communications system, a line current protector **MUST** be installed at the entry/exit points of ALL buildings through which the line passes. Only one protector is needed at each installation point.

For 2-wire installations, the following is recommended:

- Lucent Technologies 4-type protectors
- ITW LINX LP-type protectors.

Lucent Technologies 3BIC (carbon block) or Lucent 3BEW (gas tube) protectors are also acceptable in a 2-wire installation.

### INSTALLATION WARNING (for the CALLMASTER V)

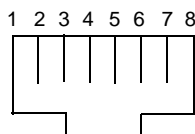

MODULAR WALL JACK WIRING			
Pin	Pair	Name	Description
4	1	BL-W	2-Wire (Tip)
5	1	W-BL	2-Wire (Ring)
1	2	W-O	Record Output
2	2	O-W	Record Output

**FAILURE TO FOLLOW THESE INSTRUCTIONS CAN CAUSE DAMAGE TO THE TELEPHONE OR CAUSE THE ASSOCIATED DEFINITY ECS CIRCUIT PACK TO REMOVE POWER TO THE TELEPHONE. IN EITHER CASE, THE TELEPHONE WILL NOT FUNCTION CORRECTLY.**

For 2-wire operation, if you need to plug the telephone into a 4-pin or 6-pin wall jack, instead of a standard 8-pin modular jack, see the Modular Wall Jack Wiring table above to ensure that the wires from the 4-pin or 6-pin wall jack are connected to the correct pins on the telephone LINE jack.

Two-wire installations must have only PBX connections on pair 1.

## Desktop Installation

**Note:** You can use the telephone without the desktop stand, if you so choose.



If you do not use the telephone with attached desktop stand, it is suggested that you place small round feet (included in a plastic bag in the box in which the telephone was packed) on each corner of the bottom of the telephone housing.

1. Turn the telephone face down on a flat surface.
2. Remove the desktop stand (the upper tabs on the stand are shown as **2** in Figure 4; the lower tab slots are shown as **6** in Figure 4). Also see Figure 5 which shows removing the desktop stand.
3. Snap one end of the line cord into the "LINE" jack (**4** in Figure 4) on the bottom of the telephone.
4. Connect the expansion module by snapping one end of the expansion module cord into the "XM24" jack on the back of the telephone (**3** in Figure 4).
5. Thread the line cord (and expansion module cord, if appropriate) through the routing channel leading to the top of the desktop stand (**1** in Figure 4). Make sure that the line cord is placed securely under the square tab (**7** in Figure 4) to the left of the "LINE" jack and that the line cord (and the expansion module cord, if appropriate) is also placed under the square tabs in the routing channel.

**Note:** If you are using an auxiliary power supply such as the 1151A1 or 1151A2 Power Unit, plug the line cord into the "PHONE" jack on the auxiliary power supply.

6. Turn the telephone right side up, with the front facing you.
7. Plug the quick-disconnect (QD) connector on the headset into the QD connector on the headset cord already plugged into one of the Headset jacks (**5** in Figure 4) on the back of your telephone.
8. If appropriate, snap the free end of the expansion module cord into the TEL SET jack on the expansion module.
9. Snap the free end of the line cord into the modular wall jack.

**Note:** If you are using an auxiliary power supply such as an 1151A1 or 1151A2 Power Unit, plug the power supply cord from the power unit's "LINE" jack into the modular wall jack.

10. Turn on the headset OR press  (or ) and listen for dial tone. If there is no dial tone, check all wire connections to make sure they are secure.

## Wall Installation

**Note:** For wall-mounting, you will need a 1-foot line cord. (This cord is *not* supplied with the telephone, but can be ordered by using this comcode: 103786760.)

1. Make sure the 8-conductor wall mount plate is in place.
2. Place the telephone face down on a flat surface.
3. Remove the desktop stand which is attached to the base of the telephone by tabs on the top and back of the stand, shown as **2** and **6** in Figure 4.
  - Press inward on the top of the stand until you can lift the upper tab(s) of the stand (shown as **1** in Figure 5 below) out of the tab slot(s) (shown as **2** in Figure 5 below) on the telephone.
  - Lift the bottom of the stand out of the lower tab slot(s).

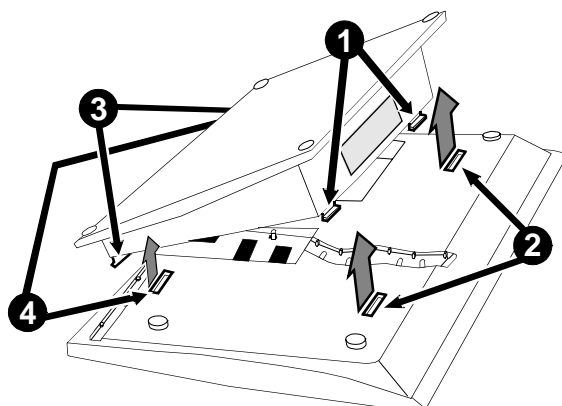
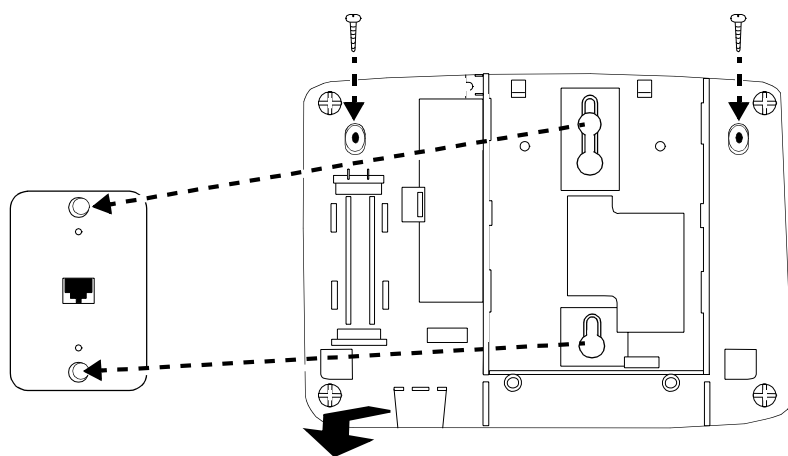

**FIGURE 5** Removing the Desktop Stand

4. Snap the line cord into the "LINE" jack in the bottom of the telephone.
5. Reverse the desktop stand so that the larger end is facing down and coil the excess line cord in the back of the deskstand.
6. Engage the upper tabs (**1** in Figure 5) of the deskstand into the slots (**4** in Figure 5). Slowly lower the reversed deskstand onto the bottom of the telephone until the lower tabs (shown as **3** in Figure 5) snap into the appropriate slots on the bottom of the telephone (**2** in Figure 5).
7. Install two screws (part of Kit #108170366 that is packaged with the telephone) to fasten the base to the bottom of the telephone. See Figure 6 for the location of the two areas in which these screws must be installed.
8. Place the free end of the line cord through the opening in the middle of the deskstand and then snap the free end of the line cord into the wall jack.
9. Place the base of the telephone on the wall-jack mounting studs, and



pull downward until it is secure. (See Figure 6.)



**FIGURE 6 Placing the Telephone on the Wall Jack Mounting Studs**

10. Plug the quick-disconnect (QD) connector on the headset into the QD connector on the headset cord already plugged into one of the Headset jacks on the back of your telephone.
11. Turn on the headset OR press **Spkr** (or ) and listen for dial tone. If there is no dial tone, check all wire connections to make sure they are secure.

## Installing the Designation Card

Use the button designation card, already installed on your CALLMASTER V when it is shipped from the factory to write the telephone number, extension, name, or feature that each call appearance/feature button can access. On the left side of the phone is a Notepad on which you can write frequently-dialed numbers or extensions.

### To label and install the designation card and telephone Notepad

1. The transparent designation card and Notepad covers are attached to the frame of the telephone by tabs on the top and bottom of the cover. Remove either or both of these covers by pulling the top tab forward and then lifting the bottom of the transparent cover from the telephone.
2. Print the numbers/features on the button designation card that corresponds with the telephone you are using. On the Notepad write frequently-called numbers or extensions or any other information that will help you use your telephone in your daily work.
3. Place the button designation card and/or the Notepad under the plastic card cover on the telephone by inserting the tabs at the bottom and then pressing the top down until it clicks.

## Orderable Cards and Equipment

The following cards and equipment are orderable.

- You can order additional designation cards in quantities of 25 cards per package. Notepads can also be ordered in quantities of 25 per package. Use the following comcodes when you place your order.
  - 25 sheets of designation cards (8-1/2" x 11")  
Comcode 847991650
  - 25 sheets of designation cards (A4-size)  
Comcode 848020749
  - 25 sheets of Notepads with 9 Notepads per sheet (8-1/2" x 11")  
Comcode 108562570
  - 25 sheets of Notepads with 9 Notepads per sheet ((A4-size)  
Comcode 108562588
  - Designation card covers can be ordered in quantities of 25 per package  
Comcode 108272402
  - Notepad covers can be ordered in quantities of 25 per package  
Comcode 108573304
- You may also order an optional handset D-Kit, so that you can connect a K-type handset to the telephone. This kit includes the handset and a handset cord, and can be ordered with one of the following numbers: (PEC 31293 & 31293A, Comcode 407904309).

**Note:** This handset is the only handset that can be used with the CALLMASTER V telephone.

- A tray with five quick reference cards can be inserted in the grooves located under the base of the CALLMASTER V telephone. The tray and the cards are ordered separately with the following numbers:  
the tray = PEC 33111, Comcode 108272584;  
the cards = Comcode 108032178).
- An XM24 Expansion Module can be connected to the CALLMASTER V to extend the number of available call appearance and/or feature buttons. The XM24 module can be ordered with the following numbers:  
A gray XM24 = PEC 33071/A, Comcode 108544511

## Free Manuals Download Website

<http://myh66.com>

<http://usermanuals.us>

<http://www.somanuals.com>

<http://www.4manuals.cc>

<http://www.manual-lib.com>

<http://www.404manual.com>

<http://www.luxmanual.com>

<http://aubethermostatmanual.com>

Golf course search by state

<http://golfingnear.com>

Email search by domain

<http://emailbydomain.com>

Auto manuals search

<http://auto.somanuals.com>

TV manuals search

<http://tv.somanuals.com>