

LUMISCOPE®

AUTOMATIC UPPER ARM Blood Pressure Monitor

Real Fuzzy
technology

Model 1130

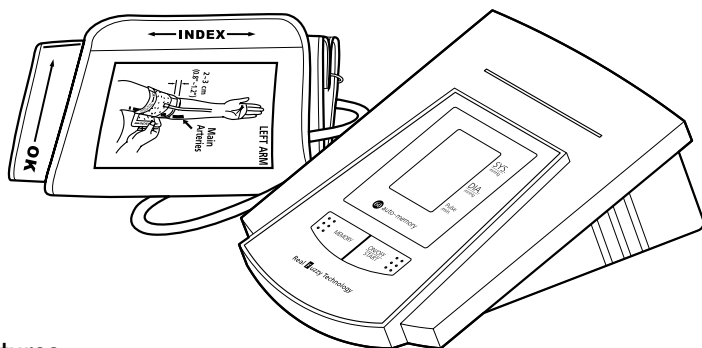

Features:

- Real Fuzzy Technology
- Automatic 60 sets of memory
- One-Touch Operation
- Easy-to-read Display

Table of Contents:

Introduction	2	Installing Battery	4
Name/Function of Each Part	2	Applying the Cuff	5
Real Fuzzy Technology	3	Taking a Measurement	6
Preliminary Remarks	3	Recalling Memory	6
About Blood Pressure	3	Helpful Tips	7
Blood Pressure Standard	3	Troubleshooting	7
Blood Pressure Fluctuation	4	Cautionary Notes	8
Display Explanation	4	Specifications	8

Introduction

Blood pressure measurements determined with your model 1130 are equivalent to those obtained by a trained observer using cuff/stethoscope auscultation method, within the limits prescribed by the American National Standard, Electronic or Automated Sphygmomanometers. The 1130 is to be used by adult consumers in a home environment.

- Please read this manual carefully before use. For specific information on your own blood pressure, contact your physician. Please be sure to keep this manual.

Parts Identification:

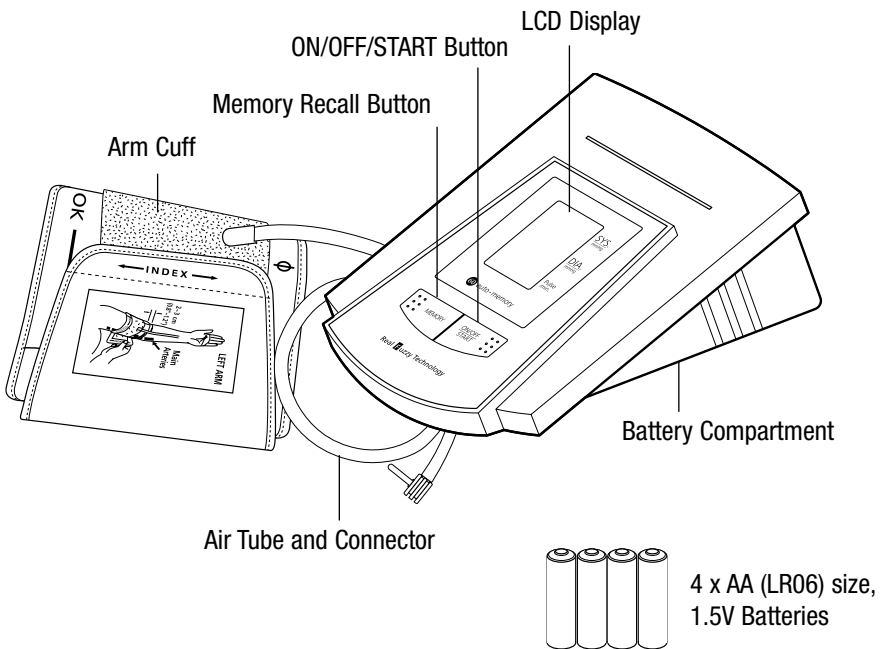

Real Fuzzy Technology

Your Lumiscope Blood Pressure Monitor uses the oscillometric method to detect your blood pressure. Before the cuff starts inflating, the device will establish a baseline cuff pressure equivalent to the air pressure. Your Lumiscope unit will determine the appropriate inflation level based on one's pressure oscillations, followed by cuff deflation. During the deflation, the device will detect the amplitude and slope of the pressure oscillations and thereby determine the systolic, diastolic, and pulse for you.

About Blood Pressure

What is Blood Pressure?

Blood pressure is the pressure exerted on the artery tube while blood flows through the arteries. The pressure measured when the heart contracts and sends blood out of the heart is systolic (highest). The pressure measured when the heart dilates with blood flowing back into the heart is called diastolic (lowest) blood pressure.

Why Measure Your Blood Pressure?

Among the various health problems afflicting modern people, problems associated with high blood pressure are by far the most common. High blood pressure's dangerously strong correlation with cardiovascular disease has made measuring blood pressure a necessity for identifying those at risk.

Blood Pressure Standard

The World Health Organization (WHO) has developed a blood pressure standard, according to which areas of low- and high-risk blood pressure are identified. This standard, however, is a general guideline and blood pressures vary between different people, age groups, etc.

It is important that you consult with your physician regularly. Your physician will tell you your normal blood pressure range as well as the point at which you will be considered at risk.

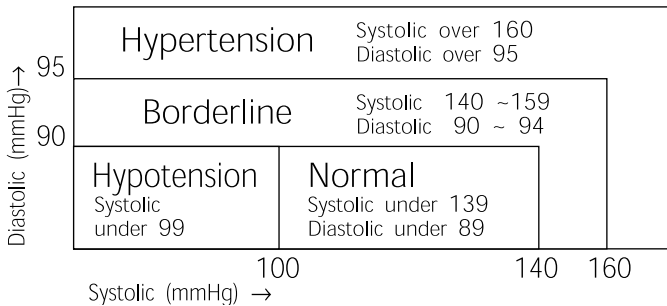

Blood Pressure Fluctuation

Blood pressure fluctuates all the time!

You should not be overly worried if you encounter two or three measurements at high levels. Blood pressure changes over the month and even throughout the day. It is also influenced by season and temperature.

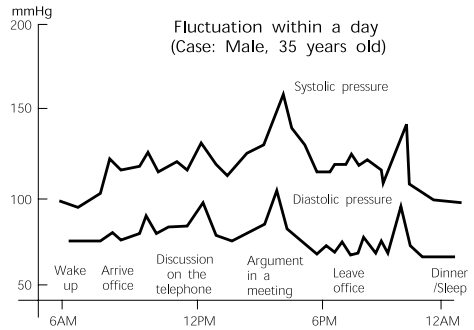

Display Explanation

Display:

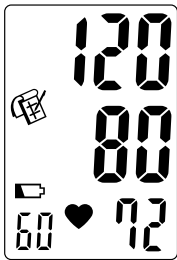

Systolic Pressure

Diastolic Pressure

Pulse Rate

No. of Memory Sequence

Icons:



Appears when measurement value is stored in memory or is recalled from memory



Appears when batteries should be replaced



Shows the pulse rate per minute



Occurs when a mistake was made during measurement

Installing Battery

1. Press down and lift the battery cover in the direction of the arrow to open the battery compartment.
2. Install or replace 4 "AA" sized batteries in the battery compartment according to the indication inside the compartment.
3. Replace the battery cover by clicking in the bottom hooks first, then push in the top end of the battery door.

You need to replace the batteries when:

1. Low battery icon appears on display.
2. The ON/OFF/START button is pushed and nothing appears on display.

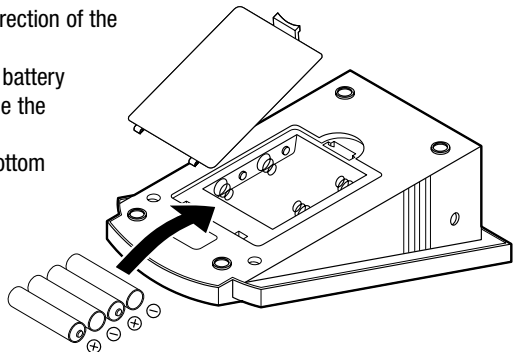

Note:  Batteries are hazardous waste. Do not dispose together with the household garbage.

Applying the Arm Cuff

1. Plug in the cuff connecting tube into the unit.
2. Unwrap the arm cuff, leaving the "Index" end of the cuff through the D-ring of the cuff.

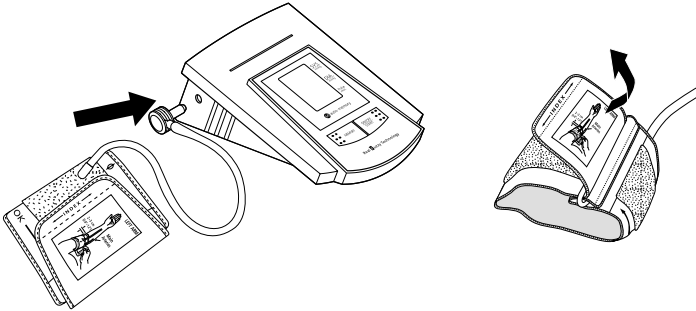

3. Put your left arm through the cuff loop. The "OK" range indication should be positioned closer to yourself with the rubber tube pointing in the direction of your arm. **Position the artery mark (ϕ) over the main arteries (on the inside of your arm) in the upper arm.** Tighten the cuff by pulling the "Index" end of the cuff.

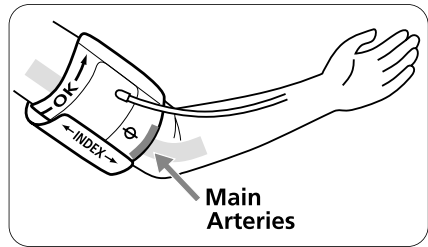
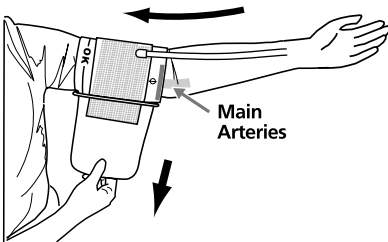

4. Turn your left palm upward and place the edge of the arm cuff at approximately 2 to 3 cm above the inner side of the elbow joint.

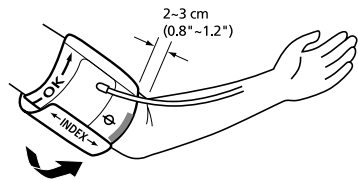

5. **If the Index line falls within the OK range, indicated at the edge of the cuff, this cuff is suitable for your use.** If the Index line falls out of the OK range, you may need a special cuff for measurement. Please visit www.lumiscope.net or contact our service department at 1-800-672-8293 for more information regarding additional cuffs.

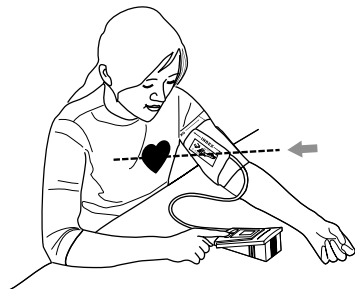

Taking a Measurement

1. Press the ON/OFF/START button. All displays will appear for approximately one second before returning to "0".

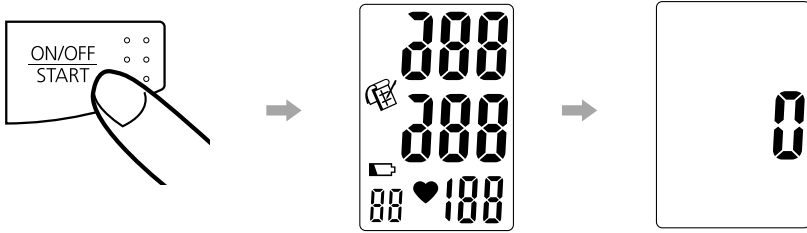

2. The unit will automatically inflate to the appropriate inflation level based on the user's pulse oscillations. Measurement will then begin. It is important to remain still and quiet during measurement. Any significant movement may affect measurement results.

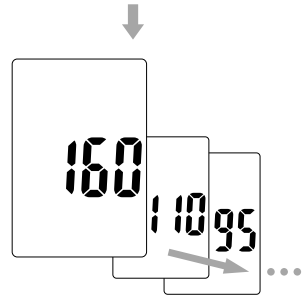

3. When the measurement is completed, systolic, diastolic and pulse will be shown simultaneously and be saved automatically in memory system. Up to 60 measurement readings can be saved in memory.

4. Press the ON/OFF/START button to turn off the power. If no button is pressed, the unit will shut off automatically in one minute.

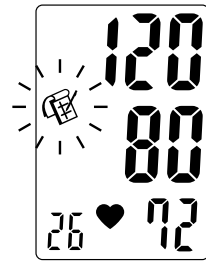

Recalling Memory

1. To recall stored blood pressure readings from memory, simply press the Memory button. The last set of memorized readings will be displayed.

2. Another press of the Memory button will recall the previous set of readings.

3. All readings stored in memory will be displayed with their sequence number.

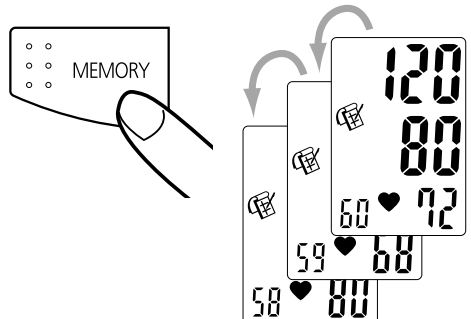

Helpful Tips

Here are a few helpful tips to help you obtain more accurate readings:

- Do not measure your blood pressure immediately after consuming a large meal. To obtain more accurate readings, please wait one hour before measuring.
- Do not smoke or drink alcohol before measuring your blood pressure.
- You should not be physically tired or exhausted while taking a measurement.
- It is important that you relax during measurement. Take 15-minute rest before a reading.
- Do not take measurements if you are under stress or under tension.
- Take your blood pressure at normal body temperature. If you are feeling cold or hot, wait a while before taking a measurement.
- If the monitor is stored at very low temperature (near freezing), have it placed at a warm location for at least one hour before using it.
- **Wait about 5 minutes before taking the next pressure measurement.**

Troubleshooting

If any abnormality should arise during use, please check the following points.

Symptom	Check Point	Correction
No display when the ON/OFF/START button is pressed	Have the batteries run down?	Replace them with two new alkaline.
	Have the batteries polarities been positioned incorrectly?	Re-insert the batteries in the correct positions.
EE mark shown on display or the blood pressure value is displayed excessively low (high)	Is the cuff placed correctly?	Wrap the cuff properly so that it is positioned correctly.
	Did you talk or move during measurement?	Measure it again quietly.
	Did you shake the arm with the cuff on?	

Note: If the unit still does not work, return it to your dealer. Under no circumstance should you disassemble the unit and attempt repairs yourself.

Cautionary Notes:

1. The unit contains high-precision assemblies. Therefore, avoid extreme temperatures, humidity, and direct sunlight. Avoid dropping or strongly shocking the main unit, and protect it from dust.
2. Clean the blood pressure monitor body and the cuff carefully with a slightly damp, soft cloth. Do not iron or wash the cuff or use chemical cleaners on it.
Never use thinner, alcohol or petrol (gasoline) as a cleaner.
3. Leaky batteries can damage the unit. Remove the batteries when the unit is not used for a long time.
4. The unit should not be operated by children.
5. If the unit is stored near freezing, allow it to acclimate at room temperature before use.
6. Your 1130 is not field serviceable. You should not use any tool to open the device nor should you attempt to adjust anything inside the device. If you have any problems, please contact the store from which you purchased your model 1130 or contact the Lumiscope Repair Department at 1-800-672-8293.
7. For users diagnosed with common arrhythmia (atrial or ventricular premature beats or atrial fibrillation), diabetes, poor circulation of blood, kidney problems, or for users who have suffered from stroke, the device might not be suitable for use.
8. Do not use on unconscious patients.

Specifications:

Measurement Method	: Oscillometric
Measurement Range	: Pressure: 20~280mmHg; Pulse: 40~180 beats/ minute
Pressure Sensor	: Semi conductor
Accuracy	: Pressure: \pm 3mmHg; Pulse: \pm 5% of reading
Inflation	: Pump Driven
Deflation	: Automatic Pressure Release Valve
Memory capacity	: 60-set memory
Auto-shut-off	: 1 minute after last button operation
Operating Environment	: Temperature: 10 °C ~ 40 °C (50 °F~104 °F); Humidity: 40 ~ 85%
Storage Environment	: Temperature: -5 °C ~ 60 °C (23 °F~140 °F); Humidity: 10 ~ 95%
Power Source	: 6V DC four LR06 (AA) Batteries
Dimensions	: 105 (L) X 160 (W) X 68 (H) mm
Weight	: 360g(G.W.) (No Batteries)
Arm circumference	: Adult: 22 ~32 cm (8.7"~12.6") (standard) : Large adult: 32 ~42 cm (12.6"~16.5") (optional)
K.B.	: Short time operation 2 minutes.

*Specifications are subject to change without notice.

Two-Year Limited Warranty:

Lumiscop guarantees this product free from defects in material and workmanship for a period of two years from the date of purchase, except as noted below:

This Lumiscop product warranty does not cover damage caused by misuse or abuse, the attachment of any unauthorized accessory, alteration to the product, or any other conditions whatsoever that are beyond the control of Lumiscop. Lumiscop shall not be responsible for any type of incidental, consequential, or special damage. All implied warranties, including, but not limited to those implied warranties of fitness and merchantability, are limited in the total duration of two years from the original date of purchase.

To obtain warranty service on your Lumiscop Blood Pressure Monitor, please contact the Lumiscop Repair Department at 1-800-672-8293 or visit www.lumiscop.net. There is a \$15 fee for return shipping and handling. Please make checks payable to The Lumiscop Co., Inc.

Upon receipt, Lumiscop will repair or replace, as appropriate, the blood pressure monitor and return it to you. Warranty is solely through the Lumiscop Repair Department. Service of this product by anyone other than the Lumiscop Repair Department voids warranty.

In the event that Lumiscop does not abide by the terms of this warranty the consumer may seek breach of contract remedies in the New York State Federal courts of law. This warranty gives you specific legal rights and you may also have other rights which vary from state to state.

Some states do not allow the exclusion or limitation of incidental or consequential damages, so the above limitation may not apply to you.

Distributed By:
The Lumiscop Co., Inc.
www.lumiscop.net
Repair Department: 1-800-672-8293

Free Manuals Download Website

<http://myh66.com>

<http://usermanuals.us>

<http://www.somanuals.com>

<http://www.4manuals.cc>

<http://www.manual-lib.com>

<http://www.404manual.com>

<http://www.luxmanual.com>

<http://aubethermostatmanual.com>

Golf course search by state

<http://golfingnear.com>

Email search by domain

<http://emailbydomain.com>

Auto manuals search

<http://auto.somanuals.com>

TV manuals search

<http://tv.somanuals.com>