

ProFX16 and ProFX22

Professional Mic/Line Mixers with FX and USB I/O

OWNER'S MANUAL

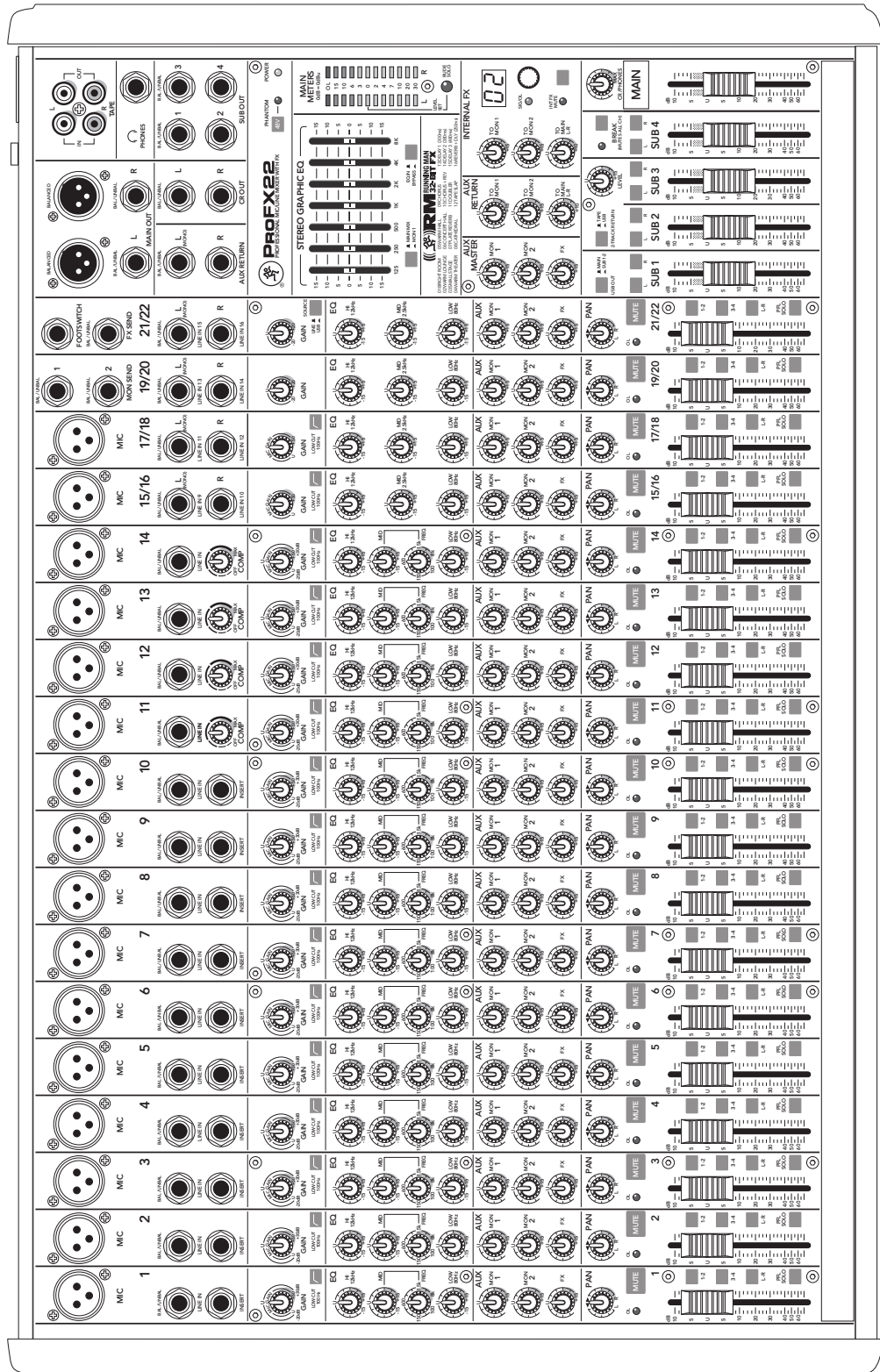

MACKIE®

Important Safety Instructions

1. Read these instructions.
2. Keep these instructions.
3. Heed all warnings.
4. Follow all instructions.
5. Do not use this apparatus near water.
6. Clean only with a dry cloth.
7. Do not block any ventilation openings. Install in accordance with the manufacturer's instructions.
8. Do not install near any heat sources such as radiators, heat registers, stoves, or other apparatus (including amplifiers) that produce heat.
9. Do not defeat the safety purpose of the polarized or grounding-type plug. A polarized plug has two blades with one wider than the other. A grounding-type plug has two blades and a third grounding prong. The wide blade or the third prong are provided for your safety. If the provided plug does not fit into your outlet, consult an electrician for replacement of the obsolete outlet.
10. Do not overload wall outlets and extension cords as this can result in a risk of fire or electric shock.
11. Protect the power cord from being walked on or pinched particularly at plugs, convenience receptacles, and the point where they exit from the apparatus.
12. Only use attachments/accessories specified by the manufacturer.
13. Use only with a cart, stand, tripod, bracket, or table specified by the manufacturer, or sold with the apparatus. When a cart is used, use caution when moving the cart/apparatus combination to avoid injury from tip-over.
14. Unplug this apparatus during lightning storms or when unused for long periods of time.
15. Refer all servicing to qualified service personnel. Servicing is required when the apparatus has been damaged in any way, such as power-supply cord or plug is damaged, liquid has been spilled or objects have fallen into the apparatus, the apparatus has been exposed to rain or moisture, does not operate normally, or has been dropped.
16. This apparatus shall not be exposed to dripping or splashing, and no object filled with liquids, such as vases or beer glasses, shall be placed on the apparatus.
17. This apparatus has been designed with Class-I construction and must be connected to a mains socket outlet with a protective earthing connection (the third grounding prong).
18. This apparatus has been equipped with a rocker-style AC mains power switch. This switch is located on the rear panel and should remain readily accessible to the user.
19. The MAINS plug or an appliance coupler is used as the disconnect device, so the disconnect device shall remain readily operable.



20. NOTE: This equipment has been tested and found to comply with the limits for a Class B digital device, pursuant to part 15 of the FCC Rules. These limits are designed to provide reasonable protection against harmful interference in a residential installation. This equipment generates, uses, and can radiate radio frequency energy and, if not installed and used in accordance with the instructions, may cause harmful interference to radio communications. However, there is no guarantee that interference will not occur in a particular installation. If this equipment does cause harmful interference to radio or television reception, which can be determined by turning the equipment off and on, the user is encouraged to try to correct the interference by one or more of the following measures:

- Reorient or relocate the receiving antenna.
- Increase the separation between the equipment and the receiver.
- Connect the equipment into an outlet on a circuit different from that to which the receiver is connected.
- Consult the dealer or an experienced radio/TV technician for help.

CAUTION: Changes or modifications to this device not expressly approved by LOUD Technologies Inc. could void the user's authority to operate the equipment under FCC rules.

21. This apparatus does not exceed the Class A/Class B (whichever is applicable) limits for radio noise emissions from digital apparatus as set out in the radio interference regulations of the Canadian Department of Communications.

ATTENTION — *Le présent appareil numérique n'émet pas de bruits radioélectriques dépassant les limites applicables aux appareils numériques de class A/de class B (selon le cas) prescrites dans le règlement sur le brouillage radioélectrique édicté par les ministere des communications du Canada.*

22. Exposure to extremely high noise levels may cause permanent hearing loss. Individuals vary considerably in susceptibility to noise-induced hearing loss, but nearly everyone will lose some hearing if exposed to sufficiently intense noise for a period of time. The U.S. Government's Occupational Safety and Health Administration (OSHA) has specified the permissible noise level exposures shown in the following chart. According to OSHA, any exposure in excess of these permissible limits could result in some hearing loss. To ensure against potentially dangerous exposure to high sound pressure levels, it is recommended that all persons exposed to equipment capable of producing high sound pressure levels use hearing protectors while the equipment is in operation. Ear plugs or protectors in the ear canals or over the ears must be worn when operating the equipment in order to prevent permanent hearing loss if exposure is in excess of the limits set forth here:

	CAUTION AVIS	
RISK OF ELECTRIC SHOCK. DO NOT OPEN RISQUE DE CHOC ELECTRIQUE. NE PAS OUVRIR		
CAUTION: TO REDUCE THE RISK OF ELECTRIC SHOCK DO NOT REMOVE COVER (OR BACK) NO USER-SERVICEABLE PARTS INSIDE. REFER SERVICING TO QUALIFIED PERSONNEL ATTENTION: POUR EVITER LES RISQUES DE CHOC ELECTRIQUE, NE PAS ENLEVER LE COUVERCLE. AUCUN ENTRETIEN DE PIECES INTERIEURES PAR L'USAGER. CONFIER L'ENTRETIEN AU PERSONNEL QUALIFIE. AVIS: POUR EVITER LES RISQUES D'INCENDIE OU D'ELECTROCUTION, N'EXPOSEZ PAS CET ARTICLE A LA PLUIE OU A L'HUMIDITE		

The lightning flash with arrowhead symbol within an equilateral triangle is intended to alert the user to the presence of uninsulated "dangerous voltage" within the product's enclosure, that may be of sufficient magnitude to constitute a risk of electric shock to persons.
Le symbole éclair avec point de flèche à l'intérieur d'un triangle équilatéral est utilisé pour alerter l'utilisateur de la présence à l'intérieur du coffret de "voltage dangereux" non isolé d'ampleur suffisante pour constituer un risque d'électrocution.

The exclamation point within an equilateral triangle is intended to alert the user of the presence of important operating and maintenance (servicing) instructions in the literature accompanying the appliance.
Le point d'exclamation à l'intérieur d'un triangle équilatéral est employé pour alerter les utilisateurs de la présence d'instructions importantes pour le fonctionnement et l'entretien (service) dans le livret d'instruction accompagnant l'appareil.

Duration, per day in hours	Sound Level dBA, Slow Response	Typical Example
8	90	Duo in small club
6	92	
4	95	Subway Train
3	97	
2	100	Very loud classical music
1.5	102	
1	105	Matty screaming at T-roy about deadlines
0.5	110	
0.25 or less	115	Loudest parts at a rock concert

WARNING — To reduce the risk of fire or electric shock, do not expose this apparatus to rain or moisture.

2 ProFX16 and ProFX22



Correct disposal of this product. This symbol indicates that this product should not be disposed of with your household waste, according to the WEEE Directive (2002/96/EC) and your national law. This product should be handed over to an authorized collection site for recycling waste electrical and electronic equipment (WEEE). Improper handling of this type of waste could have a possible negative impact on the environment and human health due to potentially hazardous substances that are generally associated with WEEE. At the same time, your cooperation in the correct disposal of this product will contribute to the effective use of natural resources. For more information about where you can drop off your

Read This Page!



You probably want to try out your new mixer right away. Before you do, please read the safety instructions on page 2, then read this page, and the rest later.

Zero the Mixer

1. Turn down all knobs except the channel EQ and pan knobs, and set all the faders fully down.
2. Set all channel EQ knobs, pan knobs, and the graphic EQ sliders at their center detent.
3. Set all buttons to the “out” position.
4. Whistle a popular show tune.

Connections

If you already know how you want to connect the mixer, go ahead and connect the inputs and outputs the way you want them. If you just want to get sound through the mixer, follow these steps:

1. Plug signal sources into the mixer, such as:
 - Microphones plugged into the mic inputs. Engage phantom power if your mics need it. Check the mic's user manual to be sure.
 - Line-level sources such as keyboards, drum machines, or CD players plugged into the line-level inputs.
2. Connect cords from the main outs to your powered speakers or amplifier.
3. Plug in the mixer's power cord to a live AC outlet and turn on the mixer.
4. If you have powered speakers, turn them on. Otherwise, hook up your passive speakers to your amp with speaker cables, and turn it on. Adjust your powered speaker or amplifier level controls to however the manufacturer recommends. (This is usually all the way up.)

Set the Gain

1. Plug something into an input. This could be an instrument, you singing or speaking, or a line level source such as a keyboard or CD player.
2. Engage the channel's PFL Solo switch to view the input level via the main meters.

3. Be sure that the volume of the input is the same as it would be during normal use, or you may have to readjust the gain in the middle of a set. You can listen with headphones if you carefully turn up the channel fader and headphones level a little.
4. The mono channel gain affects the mic and the line inputs. The stereo channel gain adjusts the stereo line inputs. Adjust as desired, and make sure that the OL LED does not come on during the loudest passages.
5. Repeat steps 1 to 4 for the other channels.



Note: there are two hybrid channels [9/10 and 11/12 on the ProFX16 and 15/16 and 17/18 on the ProFX22] that have both mono mic and stereo line inputs. In these channels, the gain control affects only the mic gain.

Instant Mixing

1. To get sound out of the speakers and into a waiting world, engage a channel's L-R assign switch, turn up that channel's fader to the “U” (unity gain) position, and slowly bring up the main fader to a comfortable listening level.
2. Sing and play. You're a star!
3. Bring in other channels as mentioned above.

USB

The USB connection allows you to play two channels of audio from your computer, and to record the main mix to your computer. This feature is explained more thoroughly on pages 4, 9-10, 16 and 23.

Notes

For optimum sonic performance, the channel faders and main fader should be set near the “U” (unity gain) markings.

Turn down all faders before making connections to and from your ProFX mixer.

When shutting down the system, turn off amplifiers or powered speakers first. When powering up, turn them on last. This will prevent the possibility of turn-on and turn-off thumps heard in your speakers.

Save the shipping box and receipt! You may need them someday.

Introduction

Awesomely unheard of features

Powerful on-board FX engine and four individual compressors

In pursuit of the ultimate Mackie “do-it-all” live sound mixer, we threw in the kitchen sink and packed this bad boy with a full set of processors allowing you to travel “rack free” while still making professional sounding mixes.

For starters, we added our patented Running Man FX processors (RMFX™) featuring 16 “gig-ready” effects right into the board. This does not include useless effects such as “the warbler” or the “insanity delay”, but rather a suite of quickly accessible and useable reverbs, choruses and delays that make enhancing your mix a breeze.

The ProFX16 and ProFX22 also have four single knob compressors to stop the dynamic signals from poking out of the mix. They are located on the last four mono mic inputs so that the most critical signals (such as vocals, snare drum, the occasional jaw harp or mountain goats) may be addressed.

Bottom line? You have an awesome mixer with Mackie sound quality, “built-like-a-tank” build quality and a recording and processing feature set that is unparalleled. Congratulations... and happy mixing!

USB Recording and Playback

The ProFX Series Mixers feature a 2x2 USB recording and playback function. This means two signals may be recorded simultaneously and a stereo mix returned to the mixer for playback.

There is a switch in the master section labeled USB OUT that allows for some powerful and flexible routing. The default switch configuration allows the L-R mix to be recorded for convenient stereo mixes of the show. Or it routes subgroups 1-2 over the USB connection to your favorite DAW software for an alternate 2-track recording when the USB OUT switch is engaged.

For playback, there is a switch in the master section labeled 2-TRACK RETURN. This switch changes the standard dual RCA inputs to main (tape, switch disengaged) to stereo USB to main (USB, switch engaged). This is an extremely convenient function for playing music over the main mix from a computer. We prefer to jam some Johnny 'The Man in Black' Cash in between bands at the local rock clubs. But feel free to play whatever you want, unless it's... ah, never mind, we won't go there!

Another cool feature of the ProFX is routing the stereo USB return to the last stereo channel of the mixer. This is a mighty fine tool for a number of live and recording uses. For example, playback through the stereo channel allows the EQ to be utilized to sweeten the sounds. It may also be used for overdubbing by sending music to the musicians' headphones through the auxes.

Features

- Professional 4•Bus live sound mixer with onboard effects and USB I/O
- Low-noise, high-headroom Mackie mic preamps with +50 dB gain range
- Dedicated inline compression for critical inputs
- 32-bit RMX™ processor with 16 “Gig-Ready” reverbs, choruses and delays
- Precision 7-band graphic EQ for tuning mains and monitors
- USB I/O for recording shows and music playback via Mac or PC
 - Stream subgroups 1-2 or main L/R to your computer for recording
 - Stereo USB/tape I/O with input level control to mains
 - Convenient USB return to stereo channel for implementation of EQ, auxes and more
- 3-band EQ with sweepable midrange on mono channels
- Multiple high-headroom line inputs
- Individual channel mute switches and overload (OL) indicators
- 18 dB/octave 100 Hz low cut filters on all mic channels
- Inserts on mono mic/line channels for connecting outboard processors
- 60mm faders for input channels, subgroups and mains
- 48V phantom power with LED for use with condenser mics
- FX mute button also controllable via footswitch
- Break switch mutes all channels for music playback between sets
- Control room / headphone outputs with rotary level control
- Balanced XLR and balanced/unbalanced 1/4-inch main outputs
- Rack-mountable design using optional rack ears [ProFX16]
- Rugged steel chassis
- Switching multi-voltage power supply for worldwide use
- Includes Tracktion 3™ Music Production Software for Mac or PC

How To Use This Manual

The first pages after the table of contents are the hookup diagrams. These show typical setups for your ProFX16 or ProFX22.

Next is a detailed tour of the entire mixer. The descriptions are divided into sections, just as your mixer is organized into distinct zones:

- **Rear Panel Connections:** The AC input, power switch and USB I/O.
- **Front Panel Connection Section and Channel Controls:** The upper section, where you connect microphones, guitars, etc and the channel strips where you adjust and control each channel.
- **Front Panel Additional Inputs & Outputs:** The upper section, where you connect loudspeakers, headphones, CD player, etc.
- **Master Controls:** The section on the right, with graphic EQ, Stereo Effect Processor and main level controls.

Throughout these sections you'll find illustrations with each feature numbered and described in nearby paragraphs.



This icon marks information that is critically important or unique to the mixer. For your own good, read them and remember them.



This icon will lead you to some explanations of features and practical tips.

Appendices

Appendix A: Service Information

- Troubleshooting
- Repair

Appendix B: Connections

- XLR Connectors
- 1/4" TRS Phone Plugs and Jacks
- 1/4" TS Phone Plugs and Jacks
- RCA Plugs and Jacks
- TRS Send/Receive Insert Jacks

Appendix C: Technical Information

- Specifications
- Dimensions
- Block Diagram
- Track Sheet

Appendix D: Table of Effects Presets

Contents

IMPORTANT SAFETY INSTRUCTIONS	2	STEREO GRAPHIC EQ, MAIN METERS & MORE.....	20
QUICK START.....	3	35. 48V PHANTOM POWER Switch.....	20
INTRODUCTION	4	36. POWER LED	20
FEATURES	5	37. STEREO GRAPHIC EQ.....	20
TABLE OF CONTENTS	6	38. MAIN MIX / MON 1 Switch.....	21
HOOKUP DIAGRAMS.....	7	39. EQ IN / BYPASS Switch.....	21
REAR PANEL - CONNECTIONS	9	40. MAIN METERS.....	21
1. POWER CONNECTION.....	9	41. RUDE SOLO LED	21
2. POWER Switch.....	9	AUX MASTERS, AUX RETURNS & INTERNAL FX ...	22
3. USB INPUT/OUTPUT	9	42. AUX MASTERS	22
4. RUNNING MAN LOGO	10	43. AUX RETURNS	22
FRONT PANEL	11	44. INTERNAL FX	22
CONNECTIONS & CHANNEL STRIP	11	45. PRESET SELECTOR	22
5. MIC INPUTS.....	11	46. PRESET DISPLAY	22
PHANTOM POWER.....	11	47. SIG / OL LED	22
6. LINE INPUTS	12	48. INT FX MUTE Switch and LED	23
7. STEREO LINE INPUTS	12	MAIN & SUBS MIX, USB OUT, 2-TRACK RETURN .	23
8. INSERT	13	49. USB OUT Switch.....	23
9. GAIN	13	50. 2-TRACK RETURN TAPE/USB Switch	23
10. LOW CUT Switch	13	51. 2-TRACK RETURN LEVEL.....	23
CHANNEL EQUALIZATION	13	52. BREAK Switch and LED.....	23
11. HIGH EQ.....	14	53. CR / PHONES	23
12. MID EQ (mono channels).....	14	54. SUBS ASSIGN Switches.....	24
13. MID EQ FREQUENCY (mono channels)	14	55. SUB 1-4 FADERS	24
14. MID EQ (stereo channels)	14	56. MAIN MIX	24
15. LOW EQ	14	APPENDIX A: SERVICE INFORMATION	25
16. AUX MON 1-2	14	APPENDIX B: CONNECTIONS	26
17. AUX FX	15	APPENDIX C: TECHNICAL INFORMATION	28
18. PAN.....	15	DIMENSIONS	29
19. OL LED.....	15	BLOCK DIAGRAM.....	30
20. MUTE Switch.....	15	TRACK SHEET.....	31
21. ASSIGN Switches	15	APPENDIX D: TABLE of EFFECTS PRESETS	34
22. PFL SOLO Switch.....	16	LIMITED WARRANTY	35
23. CHANNEL FADER	16		
24. USB Switch	16		
25. COMPRESSOR.....	17		
ADDITIONAL INPUTS & OUTPUTS	18		
26. MON SEND	18		
27. FX SEND	18		
28. FX FOOTSWITCH	18		
29. L/R AUX RETURN	19		
30. L/R MAIN OUT: XLR & 1/4"	19		
31. L/R CR OUT.....	19		
32. SUB OUT 1-4	19		
33. PHONES	19		
34. TAPE INPUTS/OUTPUTS	19		

Hookup Diagrams

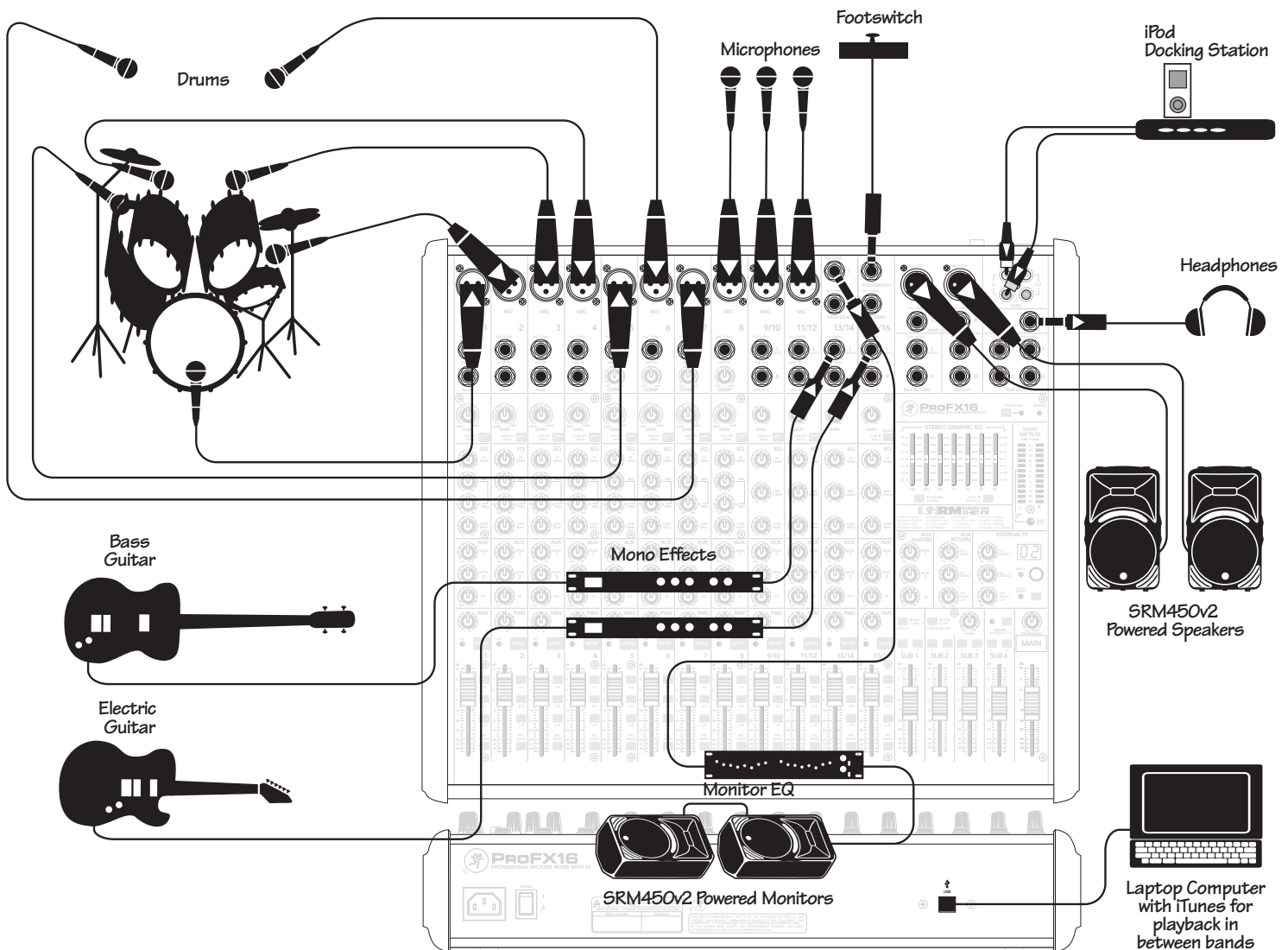

This diagram shows a mic'd up drum kit utilizing the first seven channels of the mixer. Microphones are connected to the next three channels for lead and background vocals. A guitar and bass are attached to the next two channels' line-level inputs, each via a mono effects processor. An iPod docking station is attached to the stereo tape inputs.

Mackie SRM450v2 powered speakers are connected to the left and right main output. Two of these speakers are also set up as stage monitors and connect to the mixer's monitor output via a graphic EQ. The aux mon controls of each channel allow you to create a stage monitor mix as desired. Headphones are used for monitoring and a footswitch allows you to mute/unmute the internal effects as desired.

A laptop connects to the USB port and allows the 2-channel main mix of the performance to be recorded to a DAW. Two channels of audio can also play from your computer to the main mix.

Typical Live Sound System

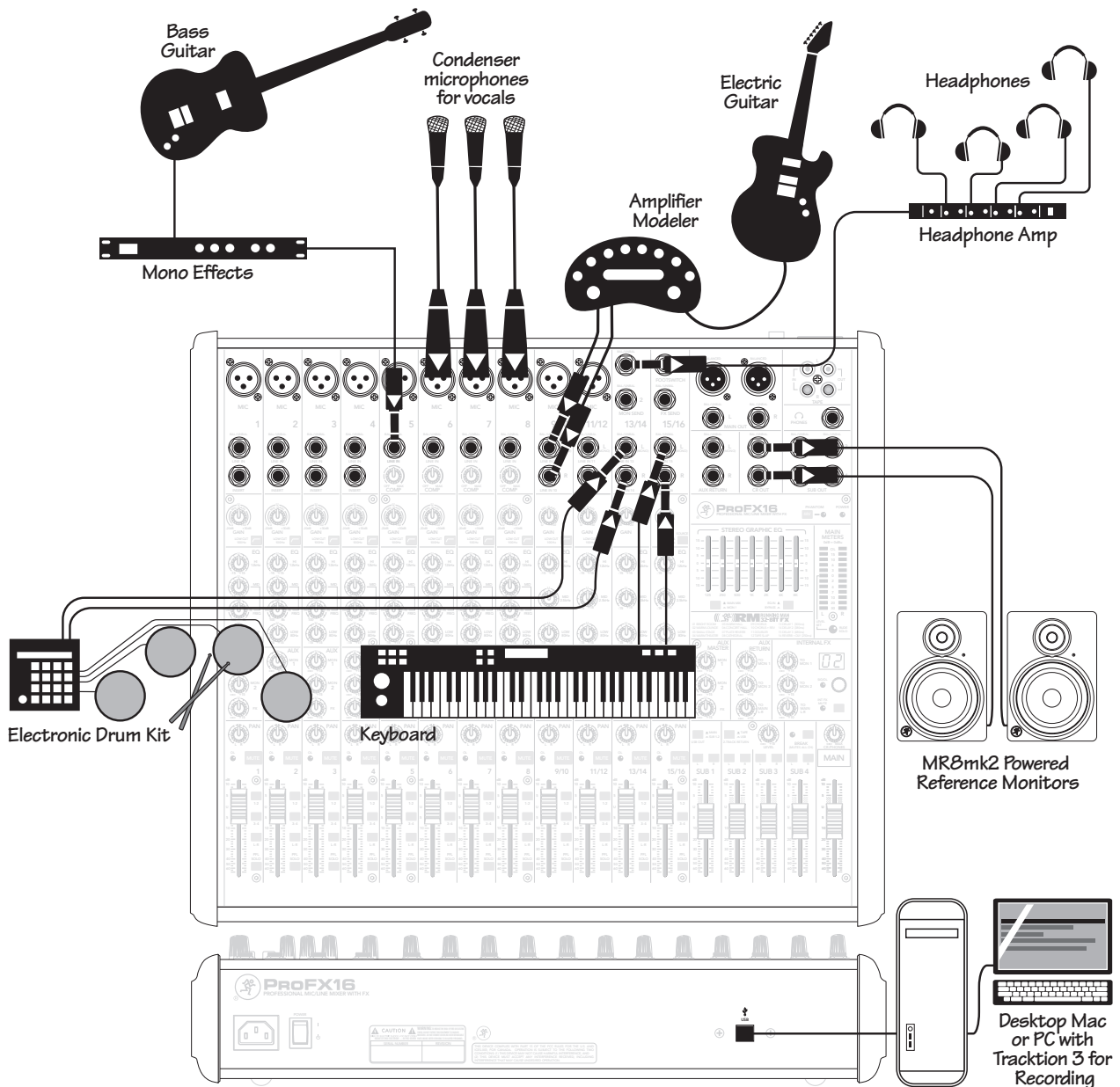

This diagram shows a bass and effects processor attached to the channel 5 line-level input, microphones attached to channels 6, 7 and 8, a guitar amplifier modeler connected to the line-level inputs of channel 9/10, an electronic drum kit connected to channel 13/14 and a keyboard attached to channel 15/16.

Mackie MR8mk2 powered reference monitors are connected to the left and right control room outputs for careful and accurate monitoring of the performance. Headphones connected to mon send 1 via a headphone amp are available for the talent to utilize when tracking.

A desktop computer connects to the USB port to record the 2-channel main mix to the DAW, as well as play back two channels from the DAW.

Typical Recording System

8 ProFX16 and ProFX22

ProFX Features – Rear Panel

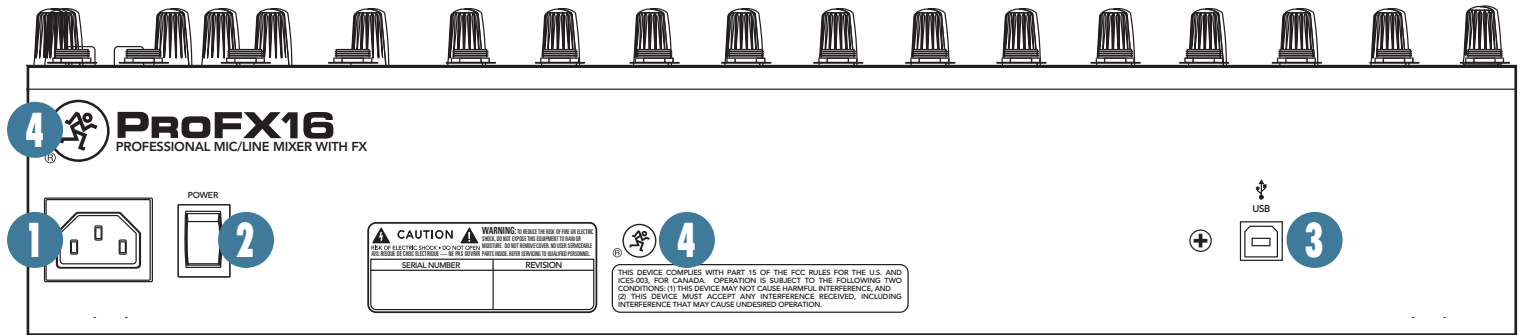

Connections

1. POWER CONNECTION

This is a standard 3-prong IEC power connector. Connect the detachable linecord (included in the box with your mixer) to the power receptacle, and plug the other end of the linecord into an AC outlet. ProFX Series mixers have a universal power supply that accepts any AC voltage ranging from 100 VAC to 240 VAC. No need for voltage select switches. It will work virtually anywhere in the world. That's why we call it a "Planet-Earth" power supply! It is less susceptible to voltage sags or spikes, compared to conventional power supplies, and provides greater electromagnetic isolation and better protection against AC line noise.



VERY IMPORTANT
Disconnecting the plug's ground pin is dangerous. Don't do it.

2. POWER Switch

Press the top of this rocker switch inwards to turn on the mixer. The front panel power LED [36] will glow with happiness...or at least it will if you have the mixer plugged into a suitable live AC mains supply.

Press the bottom of this switch to put the mixer into standby mode. It will not function, but some circuits are still live. To remove AC power, either turn off the AC mains supply, or unplug the power cord from the mixer and the AC mains supply.



A CLOSER LOOK
As a general guide, you should turn on your mixer first, before any external power amplifiers or powered speakers, and turn it off last. This will reduce the possibility of any turn-on, or turn-off thumps in your speakers.

3. USB INPUT/OUTPUT

The built-in USB interface allows for some powerful and flexible routing. It is a 2x2 interface allowing you to record two streams from the mixer, or to input stereo playback from a computer and route it to nearly any output or pair of outputs on the mixer.

The USB routing capabilities are as follows:

USB input TO the mixer - playback:

(1) Stereo channel 15/16 (on the ProFX16) and 21/22 (on the ProFX22) features a USB button, so one may route computer output (such as iTunes®) down the last stereo channel of the board. This stereo signal may then be EQ'd, sent to auxiliaries (i.e. to feed monitors, headphones or effects) and is routable to mains and/or subgroups via the fader routing features that are available on all other channels. In short, this signal may be sent to nearly any desired output or pair of outputs. Additionally, the gain knob at the top of this channel strip adjusts the USB input level to the mixer to achieve an optimal signal level.

(2) The 2-Track Return section features a flip switch, so a "Tape" source (such as an iPod® connected via RCA cables) or the USB signal from a computer (playing Windows Media Player® files, for example) may be routed to the main bus. This section also features an input level adjustment for fading house music up and down between bands, at a house of worship, or any other event where this may be necessary.

USB output FROM the mixer - recording, etc:

In the USB OUT section you may select either the main mix (disengaged) or subgroups 1-2 (engaged) from the conveniently titled USB OUT switch [49]. The USB tap points for the subgroups are pre-fader and signals will show up on the DAW dependent upon how they are panned on the channels.

In other words, if subgroups 1 and 2 are used to sub-mix drums and those drums have a stereo image (e.g. overheads and toms pan according to desire), this stereo image is retained in the DAW inputs (assuming subgroup 1 is set to "L" and subgroup 2 is set to "R"). Any adjustments made to the subgroup drum levels during the show only pertain to the live show itself; recording levels are not adjusted in the DAW unless they are adjusted on the channels.

Likewise, it is possible to record the main mix to take home a copy of the live show. These levels are also pre-main fader. Therefore, levels may be mixed up or down in the DAW later depending on the needs of the recording versus the live show. The end result is that fade-ins and/or fade-outs made during the show do not affect recorded levels.

4. RUNNING MAN LOGO

The Running Man logo has been a point of controversy since its inception.

The history of the Running Man is rather vague; nor do we know what he is running from...or towards? Or perhaps the man is running sound and not actually running to or from anything or anyone. Here is what we do know:

Origins:

It originated in the early '90s when founder Greg Mackie decided that a logo was just as (if not moreso) important than just the name. He stated that, "brands are not recognized by name alone, but by their accompanying logo...take a look at the logos of McDonald's®, Nike®, Microsoft® and Apple®. You can recognize those brands based on the logo alone."

He quickly assembled a team to design what would eventually become the Running Man logo. Here are a few early examples that were eventually rejected:

Round One Rejects

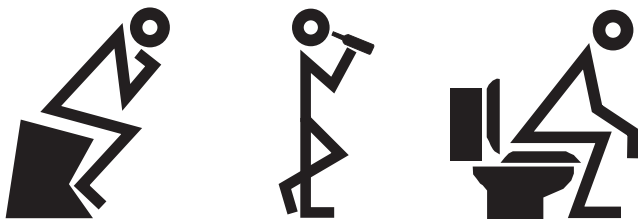

Thinking Man

Drinking Man

Stinking Man

Round Two Rejects

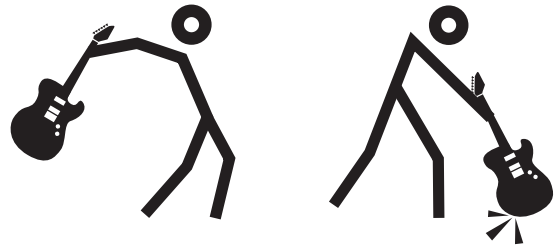

Smashing Guitar Man

Then, in the early 2000s, the graphic designers decided to give the Running Man logo some color, basically adding a theme to "spice it up". This idea didn't take off, so it was eventually shelved.



Jazz Man

Reggae Man

Country Man



Rockabilly Man

Samba Man

Metal Man

Current status, the future and beyond:

The current status is easy; it's as you see it today on every Mackie product. Who knows what the future of the Running Man logo holds? It's like the wheel analogy: why fix it if it ain't broke? The Running Man logo may be seen all over the world, from the tiniest hole-in-the-wall clubs to the biggest sized arenas, mid-sized theatres, houses of worship, casinos and more!

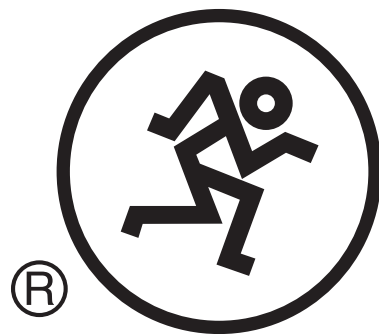

Running Man (in all his glorious glory)

ProFX Features

Front Panel - Connections and Channel Strip

The vertical channel strips look very similar, and have only a few differences between them. Each channel works independently, and just controls the signals plugged into the inputs directly above them.

5. MIC INPUTS

This is a female XLR connector that accepts a balanced mic or line level input from almost any type of source. The mic preamps feature our XDR2 design, with higher fidelity and headroom rivaling any standalone mic preamp on the market today.

The XLR inputs are wired as follows:

- Pin 1 = Shield or ground
- Pin 2 = Positive (+ or hot)
- Pin 3 = Negative (- or cold)

We use phantom-powered, balanced inputs just like the big mega-consoles, for exactly the same reason: This kind of circuit is excellent at rejecting hum and noise.

Professional ribbon, dynamic, and condenser mics all sound excellent through these inputs. The mic/line inputs will handle any kind of level you can toss at them, without overloading.

Microphone-level signals are passed through the mixer's splendid microphone preamplifiers to become line-level signals.

See Appendix B (page 26) for further details and some rather lovely drawings of the connectors you can use with your mixer.

PHANTOM POWER

Most modern professional condenser mics require 48V phantom power, which lets the mixer send low-current DC voltage to the mic's electronics through the same wires that carry audio. (Semi-pro condenser mics often have batteries to accomplish the same thing.) "Phantom" owes its name to an ability to be "unseen" by dynamic mics (Shure SM57/SM58, for instance), which don't need external power and aren't affected by it anyway.

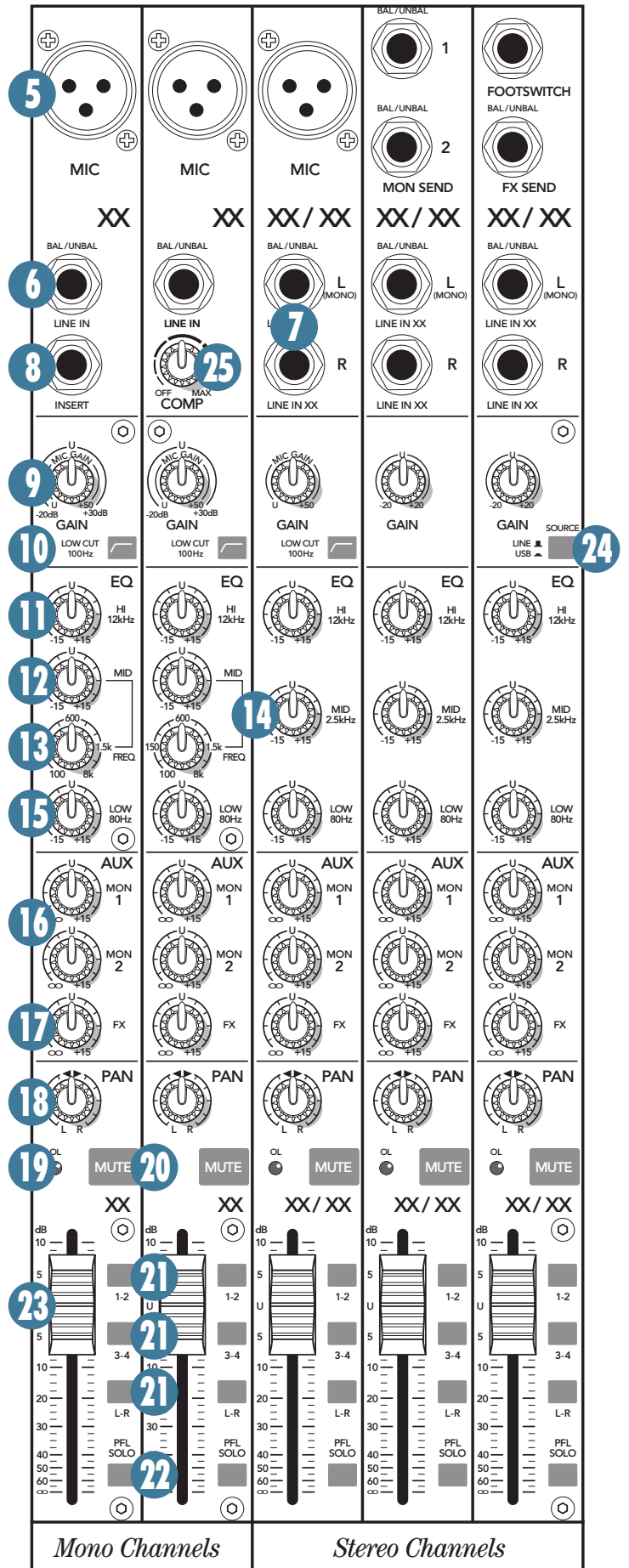

Channels 1-8 on ProFX16 Channels 9-16 on ProFX16
 Channels 1-14 on ProFX22 Channels 15-22 on ProFX22

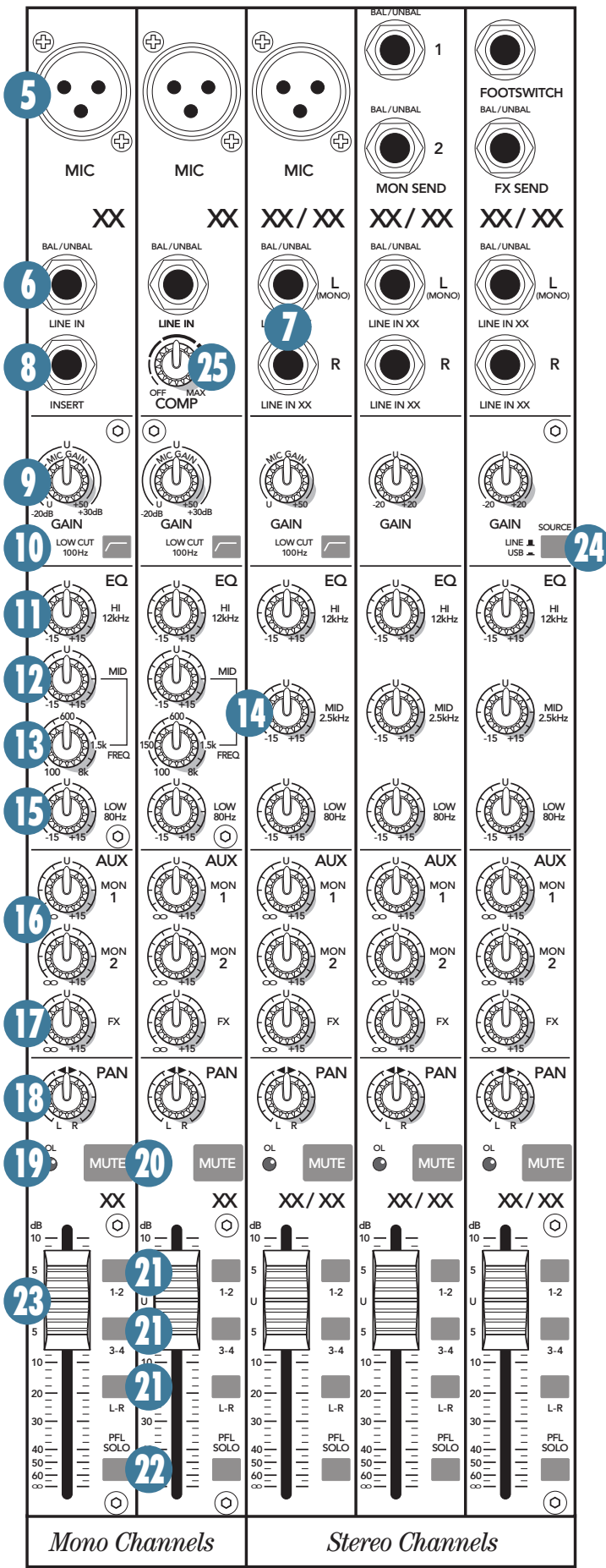

Channels 1-8 on ProFX16 Channels 9-16 on ProFX16
 Channels 1-14 on ProFX22 Channels 15-22 on ProFX22

Phantom power may be selected by engaging the mixer's phantom [35] switch.

VERY IMPORTANT Never plug single-ended (unbalanced) microphones, or ribbon mics into the mic input jacks if phantom power is on. Do not plug instrument outputs into the mic XLR input jacks with phantom power on, unless you are certain it is safe to do so.

6. LINE INPUTS

These 1/4" jacks share circuitry (but not phantom power) with the mic preamps, and can be driven by balanced or unbalanced sources.

To connect balanced lines to these inputs, use a 1/4" Tip-Ring-Sleeve (TRS) plug, wired as follows:

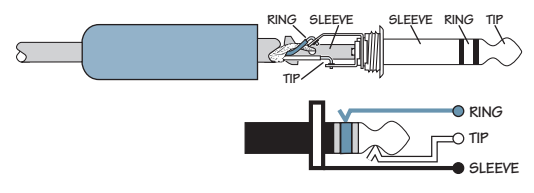

Tip = Positive (+ or hot)
 Ring = Negative (- or cold)
 Sleeve = Shield or ground

To connect unbalanced lines to these inputs, use a 1/4" mono (TS) phone plug, wired as follows:

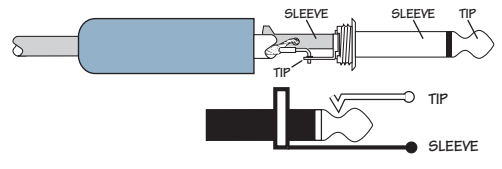

Tip = Positive (+ or hot)
 Sleeve = Shield or ground

7. STEREO LINE INPUTS

The stereo line inputs are designed for 1/4" TRS balanced or 1/4" TS unbalanced signals. They may accept any line-level instrument, effects device, CD player, etc.

Level control is available -20 dB to +20 dB. If you are connecting a mono source, use the left (mono) input, and the mono signals will appear on both sides of the main mix.

The first two stereo channels [9/10 and 11/12 on the ProFX16 and 15/16 and 17/18 on the ProFX22] are hybrid channels, each with a mic input XLR jack [5] and low cut switch [10]. In these channels, the gain control [9] only affects the mic input. The stereo line inputs are fixed at unity gain.

8. INSERT

These unbalanced 1/4" jacks are for connecting serial effects processors such as compressors, equalizers, de-essers, or filters. The insert point is after the gain control [9] and low cut filter [10], but before the channel's EQ [11-15] and level [23]. The channel signal can go out of the insert jack to an external device, be processed and come back in on the same insert jack.

To do this requires a standard insert cable that must be wired thusly:

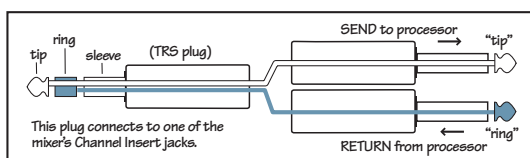

Tip = send (output to effects device)

Ring = return (input from effects device)

Sleeve = common ground

Insert jacks may be used as channel direct outputs; post-gain, and pre-EQ. See the connector section on page 27 (figure G) showing three ways to use insert cables.

"U" like Unity gain

Mackie mixers have a "U" symbol on almost every level control. It stands for "unity gain," meaning no change in signal level. The labels on the controls are measured in decibels (dB), so you'll know what you're doing level-wise if you choose to change a control's settings.

9. GAIN

If you haven't already, please read the level-setting procedure on page 3.

The gain knobs adjust the input sensitivity of the mic and line inputs. This allows signals from the outside world to be adjusted to run through each channel at optimal internal operating levels.

If the signal originates through the mic XLR jack, there will be 0 dB of gain with the knob fully down, ramping to 50 dB of gain fully up.

Through the 1/4" line input of channels 1-8 (ProFX16) and channels 1-14 (ProFX22), there is 20 dB of attenuation fully down and 30 dB of gain fully up, with unity gain "U" at 12:00.

Through the 1/4" line input of channels 13/14 and 15/16 (ProFX16) and 19/20 and 21/22 (ProFX22), there is 20 dB of attenuation fully down and 20 dB of gain fully up, with unity gain "U" at 12:00.

This 20 dB of attenuation can be very handy when you are inserting a hot signal, or when you want to add EQ gain, or both. Without this "virtual pad," there is more chance of channel clipping.

10. LOW CUT Switch

All mono channels have a low-cut switch (often referred to as a high-pass filter) that cuts bass frequencies below 100 Hz at a rate of 18 dB per octave.

We recommend that you use low-cut on every microphone application except kick drum, bass guitar, or bassy synth patches. These aside, there isn't much down there that you want to hear, and filtering it out makes the low stuff you do want much more crisp and tasty. Not only that, but low-cut can help reduce the possibility of feedback in live situations, and it helps to conserve amplifier power.



Another way to consider low-cut's function is that it actually adds flexibility during live performances. With the addition of low-cut, you can safely use low equalization on vocals. Many times, bass shelving EQ can really benefit voices. Trouble is, adding low EQ also boosts stage rumble, mic handling clunks and breath pops from way-down low. Applying low-cut removes all those problems, so you can add low EQ without blowing your subwoofers.

CHANNEL EQUALIZATION (EQ)

All ProFX mono channels have 3-band EQ with shelving hi, peaking mid with adjustable mid frequency and shelving low. The stereo channels have a peaking mid EQ control in addition to the shelving hi and shelving low EQ controls.

Shelving means that the circuitry boosts or cuts all frequencies past the specified frequency. For example, the low EQ boosts bass frequencies below 80 Hz and continuing down to the lowest note you never heard. Peaking means that certain frequencies form a "hill" around the center frequency.



With too much EQ, you can really upset things. We've designed a lot of boost and cut into each equalizer circuit because we know that everyone will occasionally need that. But if you max the EQ on every channel, you'll get mix mush. Equalize subtly and use the left sides of the knobs (cut), as well as the right (boost). If you find yourself repeatedly using a lot of boost or cut, consider altering the sound source, such as placing a mic differently, trying a different kind of mic, a different vocalist, changing the strings, or gargling.

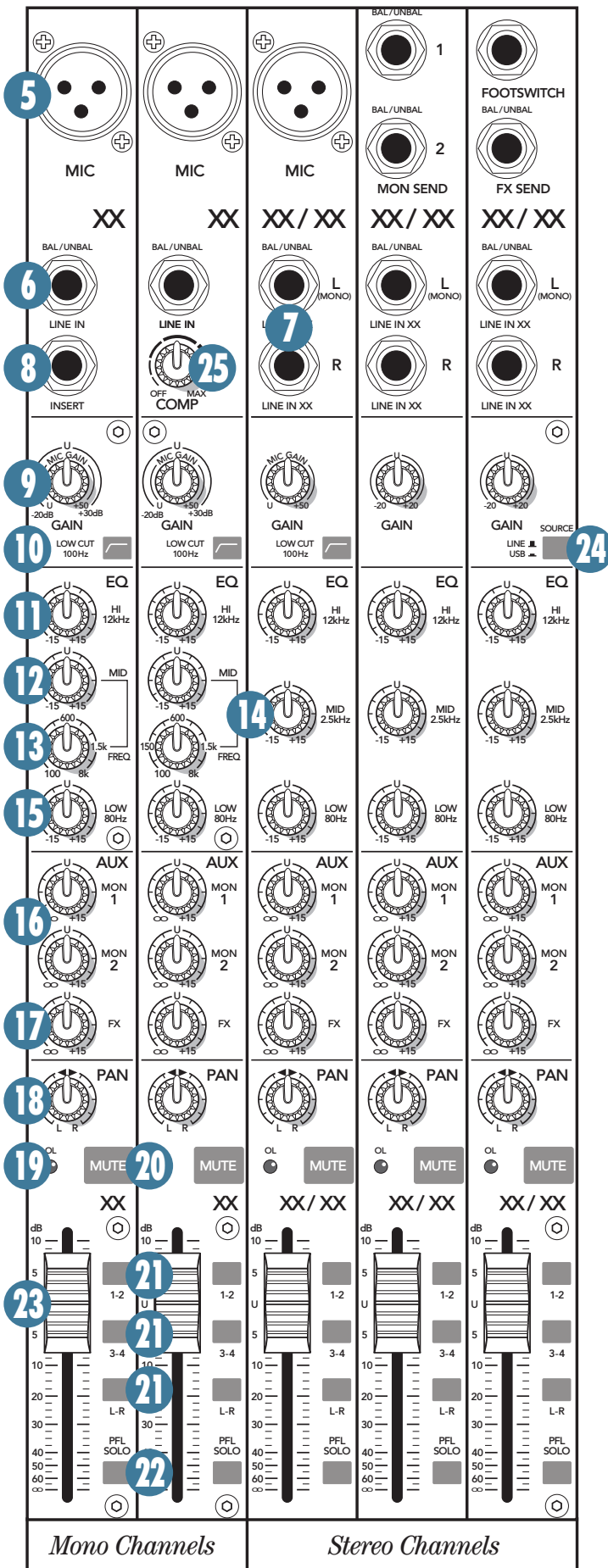

Channels 1-8 on ProFX16 Channels 9-16 on ProFX16

Channels 1-14 on ProFX22 Channels 15-22 on ProFX22

11. HI EQ

The hi EQ provides up to 15 dB of boost or cut above 12 kHz, and it is also flat (no boost or cut) at the detent. Use it to add sizzle to cymbals, an overall sense of transparency, or an edge to keyboards, vocals, guitar and bacon frying. Turn it down a little to reduce sibilance or to mask tape hiss.

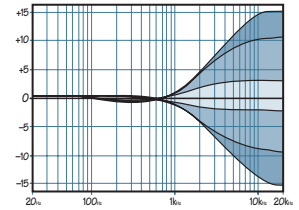

12. MID EQ and 13. FREQ (mono channels only)

The mono channels employ a semi-parametric mid-sweep EQ. The gain (up to 15 dB of boost or cut) is set via the mid eq [12], and then "aimed" at a specific frequency, from 100 Hz to 8 kHz, via freq [13].

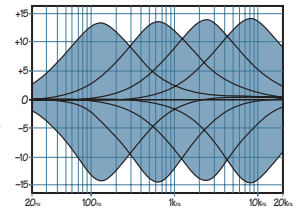

14. MID EQ (stereo channels only)

Short for "midrange," this knob provides up to 15 dB of boost or cut, centered at 2.5 kHz, also flat at the center detent. Midrange EQ is often thought of as the most dynamic, because the frequencies that define any particular sound are almost always found in this range. You can create many interesting and useful EQ changes by turning this knob down as well as up.

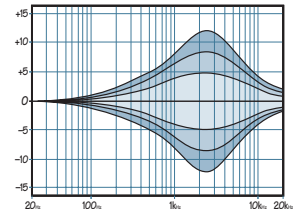

15. LOW EQ

The low EQ provides up to 15 dB of boost or cut below 80 Hz. The circuit is flat at the center detent position. This frequency represents the punch in bass drums, bass guitar, fat synth patches, and some really serious male singers who eat raw beef for breakfast.

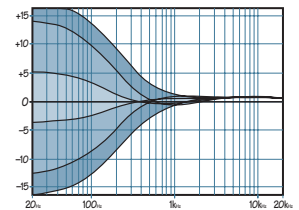

16. AUX MON 1-2

These knobs tap a portion of each channel's signal to set up a nice monitor mix feeding stage monitors, independent of the main mix. Adjust these controls on each channel until the band is happy with the stage monitor mix.

The controls are off when fully turned down, deliver unity gain at the center detent, and can provide up to 15 dB of gain turned fully up.

The pan [18], mute [20] and channel fader [23] do not affect the monitor output, but the other channel controls will. The aux mon is pre-fader.

The overall output level may be adjusted with the aux master mon knobs [42] and monitor 1's EQ tweaked with the graphic EQ [37] if the main mix/mon 1 switch [38] is pressed in. Internal FX may also be added to the monitor mix with the internal FX to mon knobs [44].

17. AUX FX

These knobs tap a portion of each channel's signal to set up a nice FX mix feeding the internal FX processor, and to feed external processors via the FX send [27].

The controls are off when fully turned down, deliver unity gain at the center detent, and can provide up to 15 dB of gain turned fully up.

The mute [20], channel fader [23] and other channel controls affect the FX output, but pan [18] does not. The aux FX is post-fader.

The FX signal reaching the internal FX processor and the FX send output jack is the sum (mix) of all the channels whose aux FX control is set to more than minimum.

The overall output level may be adjusted with the aux master FX knob [42]. FX are added to the main mix by increasing the level of the internal FX to main L-R knob [44]. Internal FX may also be added to the monitor mix by increasing the level of the internal FX to mon knobs [44].

18. PAN

This control allows you to adjust how much of the channel signal is sent to the left versus the right outputs.

With the knob panned hard left, the signal feeds the main left, sub 1, or sub 3 busses, depending on the setting of the assign switches [21]. With the knob panned hard right, the signal feeds the main right, sub 2, or sub 4 busses, again dependent on the setting of the assign switches.

The pan control employs a design called "Constant Loudness." If you have a channel panned hard left (or right) and then pan to the center, the signal is attenuated about 3 dB to maintain the same apparent loudness. Otherwise, it would make the sound appear much louder when panned center.

19. OL LED

This LED indicates the channel's signal level after the gain [9] and EQ controls [11-15], but just before the channel's level [23]. So even if the level is turned down, you can see if the channel is being overloaded.

The OL (overload) LED will come on when the channel's input signal is too high. This should be avoided, as distortion will occur. If the OL LED comes on regularly, check that the gain control [9] is set correctly for your input device, and that the channel EQ is not set with too much boost. The OL LED will also illuminate when a channel's mute switch [20] is engaged.

20. MUTE Switch

Mute switches do just what they sound like they do. They turn off the signal by "routing" it into oblivion. Engaging a channel's mute switch (almost) provides the same results as turning the fader all the way down (a pre-aux send is not affected by the channel fader, but it is by the mute switch). Any channel assignments to main mix, subgroup 1-2, or subgroup 3-4 will be interrupted and all of the aux sends will be silenced (both pre- and post-fader). The channel insert [8] will continue to provide a signal when a channel is muted. The OL LED [19] will illuminate when a channel's mute switch is engaged.

21. ASSIGN Switches

Alongside each channel fader are three buttons referred to as channel assignment switches. Used in conjunction with the channel's pan knob [18], they are used to determine the destination of the channel's signal.

With the pan knob at the center detent, the left and right sides receive equal signal levels (main mix L-R, sub 1-2 and sub 3-4). To feed only one side or the other, turn the pan knob accordingly.

If you are doing a mixdown to a 2-track, for example, simply engage the main mix switch on each channel that you want to hear, and they will be sent to the main mix bus. If you want to create a group of certain channels, engage either the 1-2 or 3-4 switches instead of the main mix, and they will be sent to the appropriate subgroup faders. From there, the groups may be sent back to the main mix (using the group assign switches [54] above the group faders [55]), allowing you to use the group faders as a master control for those channels.

If you are creating new tracks or bouncing existing ones, you will also use the 1-2 and 3-4 switches, but not the main mix switch. Here you do not want the groups sent back into the main mix bus, but sent out, via the sub out jacks [32], to your multitrack inputs.

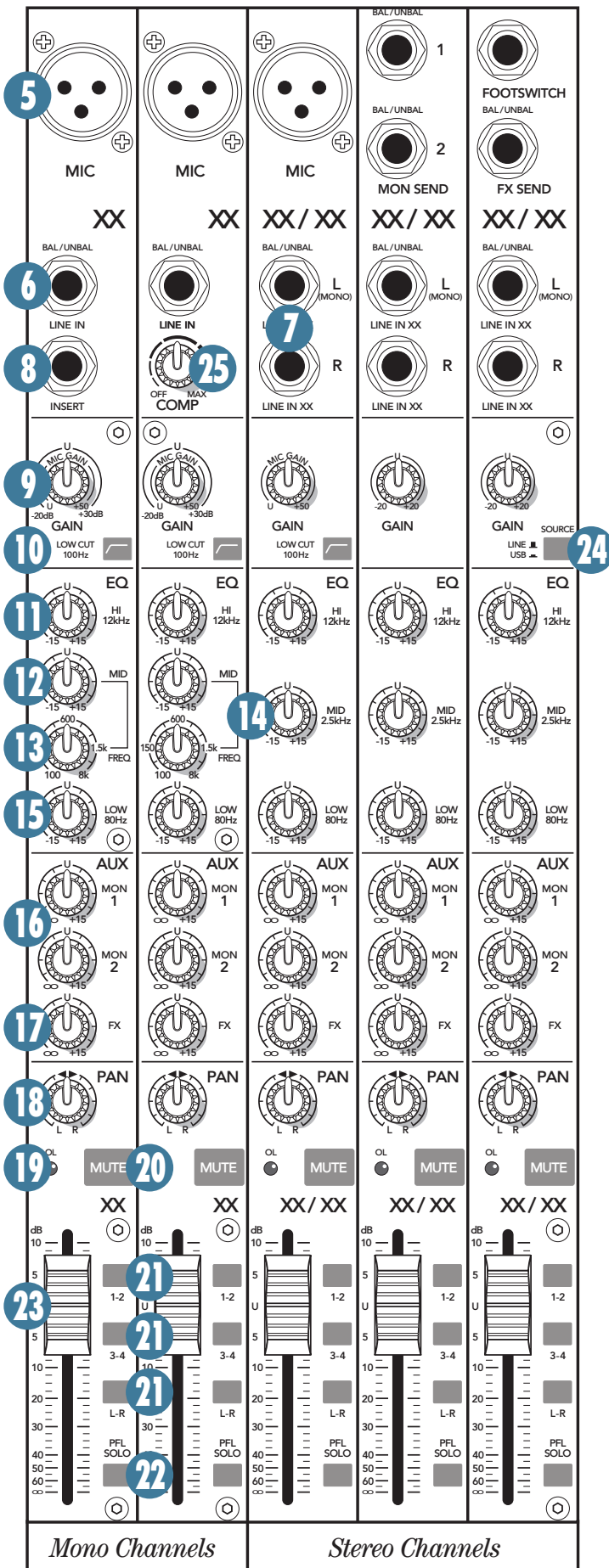

Channels 1-8 on ProFX16 Channels 9-16 on ProFX16

Channels 1-14 on ProFX22 Channels 15-22 on ProFX22

22. PFL SOLO Switch

When a channel's solo switch is engaged, any existing selection is replaced by the solo signal, appearing at the control room outputs [31], phones [33] and at the left meter [40]. The audible solo levels are then controlled by the control room knob [53]. The solo levels appearing on the meters are not controlled by the control room knob [53] - you would not want that, anyway. What you do want to see is the actual channel level on the meters regardless of how loud the control room and phones output levels might be.

PFL means Pre-Fader Listen (post-EQ). With the PFL Solo switch engaged, solo will not be affected by a channel's mute switch [20] position.



Remember, PFL taps the channel signal before the fader. If you have a channel's fader set way below "U" (unity gain), solo will not know that and will send a unity gain signal to the C-R outs [31], phones output [33] and meter display [40], which may raise some eyebrows.

23. CHANNEL FADER

This is the last control in a channel's signal path, and it adjusts the level of each channel onto the main mix. The "U" mark indicates unity gain, meaning no increase or decrease of signal level. All the way up provides an additional 10 dB, should you need to boost a section of a song. If you find that the overall level is too quiet or too loud with the level near unity, check that the gain control [9] is set correctly.

24. USB Switch

The USB switch on the last stereo channel provides stereo playback of iTunes®, or a DAW via the USB connection. Like any other input, this signal may also be EQ'd, sent to an aux bus, or mixed in with the other signals and assigned to subgroups or main outs. This switch overrides the TRS inputs [6, 7].

25. COMPRESSOR

Each of the last four mono channels of the ProFX mixer has an in-line compressor circuit with a variable threshold. This is very useful for compression of vocals, and snare drums, for example, so you might consider connecting your vocal and drum mics to these channels, rather than one of the other channels.

When the incoming signal exceeds the threshold level set by this knob, the signal level is automatically compressed. This reduces the dynamic range and reduces the chance of distortion due to overloading the input signals.



Dynamic range is the difference in level between the quietest and loudest parts of a song. A compressor “squeezes” the dynamic range, resulting in an overall steadier, more constant volume level for the signal. It helps sources, such as vocals, “sit” properly in the mix; it is very useful for live sound.

The compression ratio is fixed at around 6:1, with a soft knee response. The threshold can be adjusted clockwise from off (no compression) to 0 dBu (max).

As an example, suppose the threshold is set to maximum. An incoming signal reaches the threshold of 0 dBu. As it increases beyond the threshold, it becomes compressed at a ratio of 6:1. This means that even if the input further increases by 6 dB, the actual output only increases by 1 dB. This compresses the output signal, so there is more protection to your system from distortion and overload due to poor microphone technique (say it ain't so) and general pops, bangs and heavy metal screaming. The soft knee means that the compression slowly ramps up to 6:1 from the threshold. It does not jump abruptly to 6:1, as this would be hard knee compression, and harder on the ears too.

The graph on this page shows the input signal level going into the compressor, versus the output level coming out of it. It is the typical graph to view when compressors are discussed, and is just the kind of thing our engineers like to discuss during the company Christmas party*.

If the compressor is off, then the input = output. For example an input signal level of +5 dBu results in an output level of +5 dBu. The diagonal line from lower left to upper right represents $x = y$, that is, input = output.

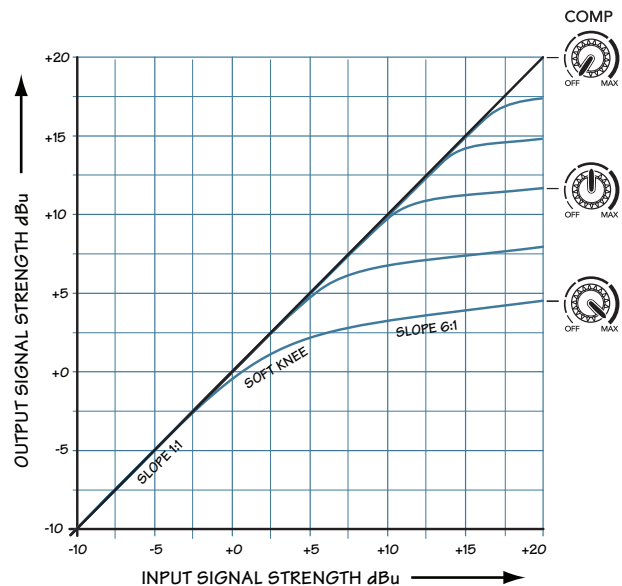

At the maximum compression, the threshold is set at 0 dBu, and the input to output relationship is represented by the lower curve. If the input is -5 dBu (that is, below the threshold), the output is -5 dBu. As the input reaches 0 dBu, the output is a bit less than 0 dBu. If the input is +5 dBu, the output is about +2 dBu. If the input reaches +10 dBu, then the output is +3 dBu. Notice the shapely curve of the soft knee between the diagonal slope of $x = y$ and the compressor slope of 6:1 (the compression ratio).

The other blue curves represent in-between positions of the compressor knob, with higher thresholds before compression begins.

Outboard compressors often have controls such as compression ratio, threshold, soft knee/hard knee, attack time, and release time. These last two affect how quickly the compressor kicks in when the input exceeds the threshold, and how quickly it is released after it drops below the threshold. In this compressor, these parameters are specially chosen to give you the best overall performance.

Adjust the threshold carefully, so your dynamic range is still lovely, without distortion or overload during the performance. Run through a few practice screams and high-notes, and adjust the compression as required.

* My High School math teacher, Mr. Marvin, thought that graphs might come in handy for me one day. Finally!

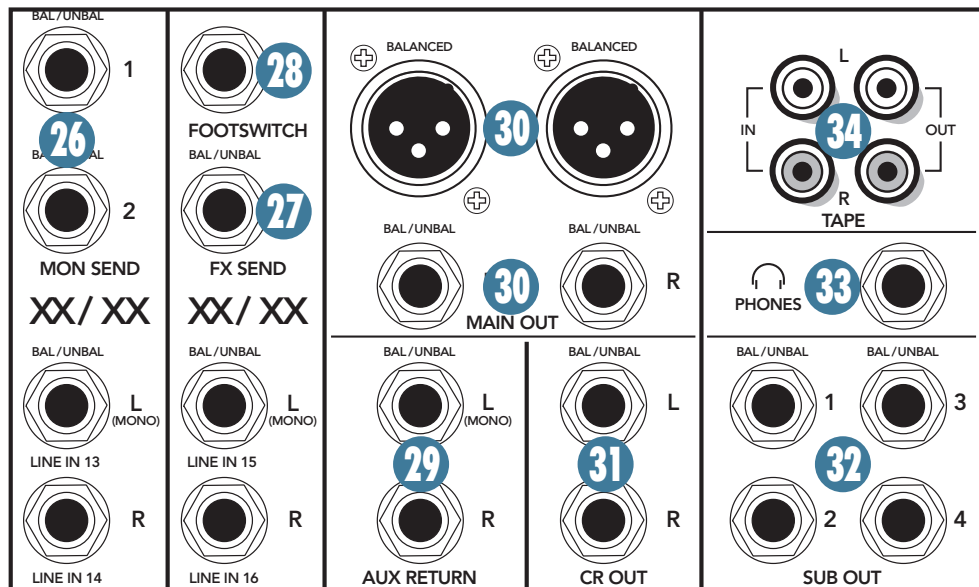

Additional Inputs & Outputs

26. MON SEND

Stage monitors allow the talented musicians in the band to hear themselves clearly on stage. This can be a good thing! The monitor mix may be carefully adjusted in level using the aux mon controls [16]. These tap a portion of each channel's signal to provide a 1/4" TRS output here to feed external stage monitors. These could either be passive stage monitors powered by an external amplifier, or powered stage monitors with their own built-in amplifier.

The monitor signal is the sum (mix) of all the channels whose aux mon control is set to more than minimum. If they want "more me and less Brian," you may turn up their channel's aux mon control, and turn down Brian's. Of course, with two monitor buses and two monitor outputs, anyone who wants "more Brian" can have their own monitor mix.

The overall output level may be adjusted with the aux master mon knob [42] and mon 1 may have its EQ tweaked with the graphic EQ [37] if the main mix/mon 1 switch [38] is pressed in. Alternatively, you could add an external graphic EQ between this output and your powered monitors. This will allow you to adjust the EQ, and minimize the chance of feedback from nearby microphones.

The monitor output is not affected by the main mix fader [56] or the channel faders [23]. This allows you to set up the monitor mix and level just right, and not have it change when a channel fader or the main mix fader is adjusted. This is known as "pre-fader."

27. FX SEND

This 1/4" TRS line-level output may be used to feed an external effects processor (FX), such as a nice sound effect, or delay unit. The output from this jack is an exact copy of what goes into the internal FX processor, being the careful mix of all channels whose aux FX control [17] is turned to more than minimum.

(The processed output of the internal FX does not come out of this output, but is added internally to the main mix or monitor mix.)

The overall output level may be adjusted with the aux master FX knob [42]. (This knob also affects the level going into the internal FX.)

The output is "post-fader," so any changes to the channel faders [23] will also affect the level going to the external processor.

The processed output from the effects processor is usually returned to the aux returns [29] or a spare channel, and you may carefully mix the original unprocessed channel (dry) and the processed channel (wet). Altering the original channel fader increases both the wet and dry signals and keeps them at the same delicate ratio. For example, the reverb remains at the same level relative to the original.

28. FX FOOTSWITCH

This 1/4" TRS connector is where to connect your favorite footswitch. This allows you to easily mute or un-mute the internal effects at will. Any one-button on/off footswitch will work.

If the internal effects have already been muted with the internal FX mute switch [48], then the footswitch has no affect.

29. AUX RETURN L/R

The stereo (aux) returns are designed for 1/4" TRS balanced or 1/4" TS unbalanced signals, from -20 dB to +20 dB. They allow the stereo processed output from external effects processors or other devices to be added to the main mix.

Level adjustment of the incoming signals is made with the aux return controls [43].

You may also use these inputs to add any stereo line-level signals to your main mix, so it could be another line-level source, not just an effects processor.

If you are connecting a mono source, use the left (mono) stereo return input, and the mono signals will appear on both sides of the main mix.

30. MAIN OUT L/R: XLR & 1/4"

The male XLR connectors provide a balanced line-level signal that represents the end of the mixer chain, where your fully mixed stereo signal enters the real world. Connect these to the left and right inputs of your main power amplifiers, powered speakers, or serial effects processor (like a graphic equalizer or compressor/limiter). The XLR outputs are 6 dB hotter than the TRS outputs.

The 1/4" TRS output connectors provide balanced or unbalanced line-level signals. Connect these to the next device in the signal chain like an external processor (compressor/limiter), or directly to the inputs of the main amplifier. These are the same signal that appears at the XLR main outputs, but 6 dB lower than the XLR outputs. When the meters read "0", these TRS outputs are at 0 dBu.

31. CR OUT L/R

These 1/4" jacks are usually patched to the inputs of a control room amplifier or a headphone distribution amplifier.

32. SUB OUT 1-4

These four 1/4" jacks are usually patched to the inputs of a multitrack deck or to secondary amplifiers in a complex installation.

33. PHONES

This 1/4" TRS connector supplies the output to your stereo headphones. It is the same signal that is routed to the control room outputs [31]. The volume is controlled with the cr/phones knob [53], right above the main mix fader [56].

Whenever a solo switch [22] is engaged, you will only hear the soloed channel(s) in the headphones. This gives you the opportunity to audition the channels before they are added to the main mix. (Solo signals reaching the headphones are not affected by the channel level or main level, therefore turn down the phones level first, as soloed channels may be loud.)

The phones output follows standard conventions:

Tip = Left channel

Ring = Right channel

Sleeve = Common ground



WARNING: The headphone amp is loud and can cause permanent hearing damage. Even intermediate levels may be painfully loud with some headphones. BE CAREFUL! Always turn the phones level control [53] all the way down before connecting headphones or pressing a solo switch, or doing anything new that may affect the headphone volume. Then turn it up slowly as you listen carefully.

34. TAPE INPUTS / OUTPUTS

The stereo unbalanced RCA inputs allow you to play a tape, CD player, iPod® dock, or other line-level source. The tape in jacks accept an unbalanced signal using standard hi-fi hookup cables.

The stereo unbalanced RCA outputs allow you to record the main stereo mix onto a tape deck, hard disk recorder, or automatic CD burner, for example. This lets you make a recording for posterity/archive/legal purposes whenever the band gets back together again.

The tape output is the stereo main mix, and it is not affected by the main mix fader [56]. The output could also be used as an extra set of main outputs for feeding another zone.

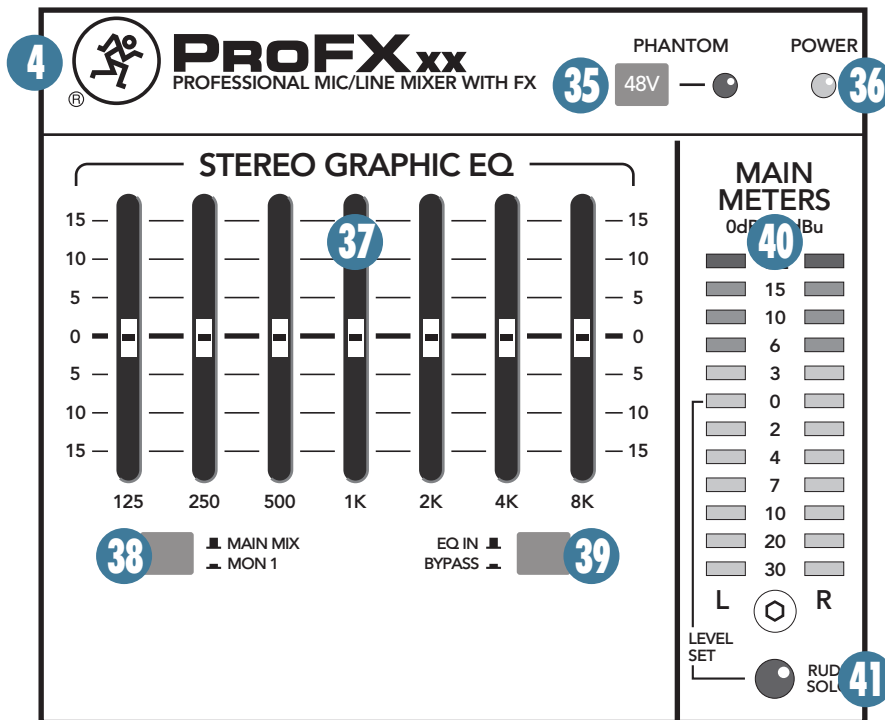

Stereo Graphic EQ, Main Meters & more!

35. 48V PHANTOM POWER Switch

Most modern professional condenser mics require 48V phantom power, which lets the mixer send low-current DC voltage to the mic's electronics through the same wires that carry audio. (Semi-pro condenser mics often have batteries to accomplish the same thing.) "Phantom" owes its name to an ability to be "unseen" by dynamic mics (Shure SM57/SM58, for instance), which don't need external power and aren't affected by it anyway.

Press this switch in if your microphone requires phantom power. (Always check the position of this switch before connecting microphones.) A red LED just to the right of the switch will illuminate to indicate that phantom power is active. This is a global switch that affects all mic channels' XLR jacks at once.



Never plug single-ended (unbalanced) microphones, or ribbon mics into the mic input jacks if phantom power is on. Do not plug instrument outputs into the mic XLR input jacks with phantom power on, unless you know for certain it is safe to do so. Be sure the main mix fader [56] is turned down when connecting microphones to the mic inputs when phantom power is turned on, to prevent pops from getting through to the speakers.

36. POWER LED

This green LED will illuminate when the mixer is turned on, as a reminder of how on it really is. If it is not on, then it is off, and the mixer becomes a rather nice weight for keeping your morning newspaper from blowing away in the wind.

If it does not turn on, make sure the power cord is correctly inserted at both ends, the local AC mains supply is active, and the power switch [2] is on.

37. STEREO GRAPHIC EQ

This 7-band graphic equalizer adjusts the main mix output. It affects the line-level outputs [30, 31], but not the headphones [33], tape outputs [34], or the USB output [3]. This EQ may be used for a monitor mix instead of the main mix if the main mix/mon 1 switch [38] is engaged. It may also be quickly bypassed using the EQ in/bypass switch [39].

Each slider allows you to adjust the level of its frequency band, with up to 15 dB of boost or cut, and no change in level at the center (0 dB) position. The frequency bands are: 125, 250, 500, 1 k, 2 k, 4 k and 8 kHz.

The EQ section comes before the main mix fader [56] and meters [40]. As with the channel EQ, just take it easy. There is a large amount of adjustment, and if you are not careful, you can upset the delicate balance of nature. Although it may not seem cool to actually turn down controls, with EQ it is often your best option. Turn down the offending frequency range rather than boosting the desired range. You may use it to reduce the level of some frequency bands where feedback occurs.

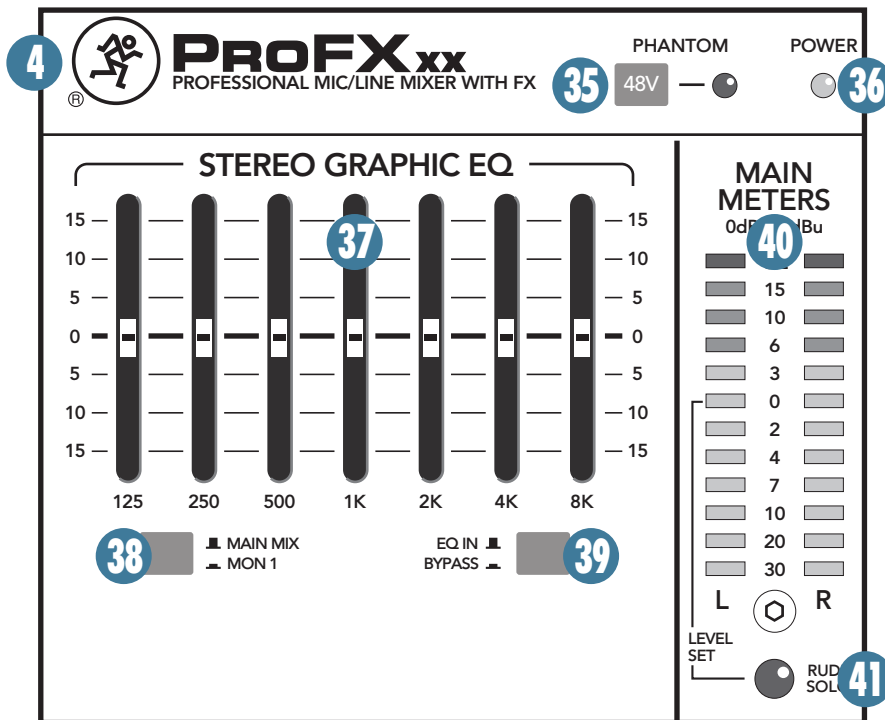

38. MAIN MIX / MON 1 Switch

This switch allows you to choose if the stereo graphic EQ [37] is used for the stereo left and right main mix or if it is used for monitors. For example, there may be times when the graphic EQ may be used wisely in the monitor mix to reduce feedback in the monitors from nearby microphones. Note that this does not affect the monitors 2 send, only the monitors 1 output.

39. EQ IN / BYPASS Switch

This switch allows you to quickly engage or disengage the stereo graphic EQ [37]. This may be used for quick checks of your EQ settings, or to shorten the signal path if you do not need to use the EQ.

40. MAIN METERS

These peak meters are made up of two columns of twelve LEDs, with three colors to indicate different ranges of signal level, traffic light style. They range from -30 at the bottom, to 0 in the middle, to +20 (CLIP) at the top.

When a channel is soloed, the right meter shows no reading, and the left meter shows the level of that channel's signal level, pre-fader.

The left meter's 0 dB LED is labeled "level set" to show where the level should be when adjusting a channel's gain [9] in the solo mode.

When 0 dBu (0.775 V) is at the main left and right TRS outputs [30], it shows as 0 dB on the meters.

You can get a good mix with peaks flashing anywhere between -20 and +10 dB on the meters. Most amplifiers clip at about +10 dBu, and some recorders aren't so forgiving either. For best real-world results, try to keep your peaks between "0" and "+6." Remember, audio meters are just tools to help assure you that your levels are "in the ballpark." You don't have to stare at them (unless you want to).

41. RUDE SOLO LED

This large red LED flashes when one or more solo switches are engaged [22]. This acts as a reminder that what you hear in the control room and headphones is the soloed channel(s). If you forget that you are in solo mode, you can easily be tricked into thinking that something is wrong with your mixer. Hence, the rude solo light. Please forgive its rudeness, it is only trying to help, and wants to be your friend.

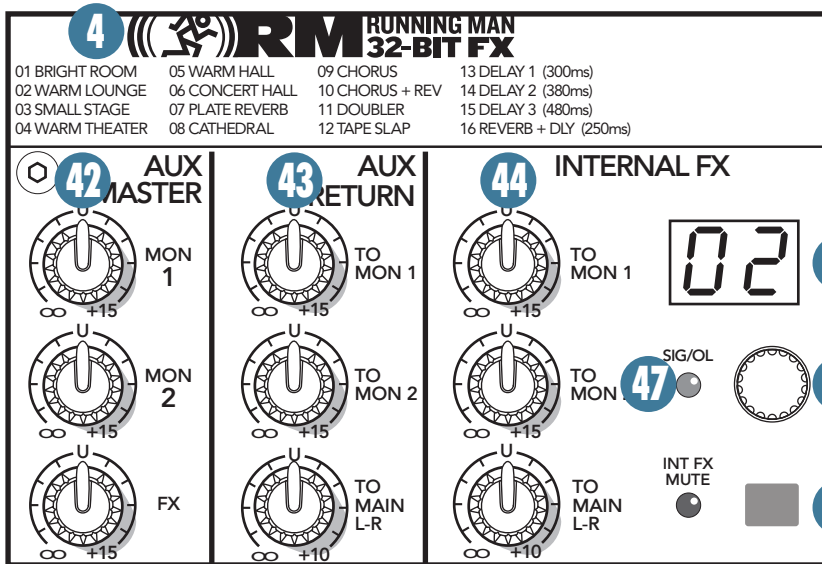

45. PRESET SELECTOR

Rotate this endless control to select one of the 16 preset effects. When the rotation stops, that preset will be loaded and become operational. The current preset number is shown in the display [46]. The different presets are shown in the table below and on the silkscreen just below the stereo graphic EQ [37]. Further details of each preset are explained in Appendix D on page 34. Only one preset may be selected at a time.

Aux Masters, Aux Returns & Internal FX

42. AUX MASTERS

These knobs provide overall control over the aux mon and aux FX levels just before they are delivered to the aux mon and aux FX outputs [26, 27], as well as internal FX in the case of the FX master. These knobs go from off to +15 db when turned all the way up.

Auxiliary is usually the knob you turn up when the lead singer glares at you, points at his stage monitor, and sticks his thumb up in the air. (It would follow that if the singer stuck his thumb down, you'd turn the knob down, but that never happens.)

43. AUX RETURNS

These three controls set the overall level of line signals received from the aux return L-R jacks [29]. These controls range from off to +15 db (to mon 1/2) and off to +10 db (to main L-R) of gain when fully clockwise, to compensate for low-level effects.



Signals passing through these controls go directly to the main mix and monitor mix where they are combined with signals from the channels.

44. INTERNAL FX

These knobs route the effects output to mon 1, mon 2 and mains independently. Use mon 1 and mon 2 to provide effects to monitors. Slowly add effects to the monitors by turning the 'to mon 1' and 'to mon 2' knobs clockwise. Use the aux master [42] to monitor the amount sent. The FX output to the mains will be heard directly from the PA.

1	Bright Room	9	Chorus
2	Warm Lounge	10	Chorus + Reverb
3	Small Stage	11	Doubler
4	Warm Theater	12	Tape Slap
5	Warm Hall	13	Delay 1 (300ms)
6	Concert Hall	14	Delay 2 (380ms)
7	Plate Reverb	15	Delay 3 (480ms)
8	Cathedral	16	Reverb + Delay (250ms)

46. PRESET DISPLAY

This display shows the number of the currently selected effects preset, as shown in the list of presets above. Rotate the preset selector knob [45] right or left to change a preset.

A new preset will be loaded approximately 1/4 of a second after you stop turning the knob, and it will be stored into the FX memory after about one second. When the mixer is turned on, the FX section will load up the last-used preset.

47. SIG / OL LED

This bi-colored LED illuminates green when the signal level going into the effects processor is within a good operating range (sig). It illuminates red if the effects processor is overloaded with too strong of a signal (ol). Turn down the FX send master level [44] and check the channel sends if these light red regularly.

The signals going into the processor are affected by the channel gain [9], EQ [11-15], and channel faders [23], as well as the channel FX sends [17] and the FX send master [42].

48. INT FX MUTE Switch and LED

When engaged, the internal effects processor is muted, and its output will not appear on the main mix or monitor mix. The adjacent mute LED will illuminate as a reminder that the effects are muted. When power is first applied, this LED will illuminate and the FX will be muted for about 10 seconds while the little FX gerbils inside settle down.

If this switch is not engaged, then the internal effects are set free and may be added as required to the main mix and/or monitor mix.

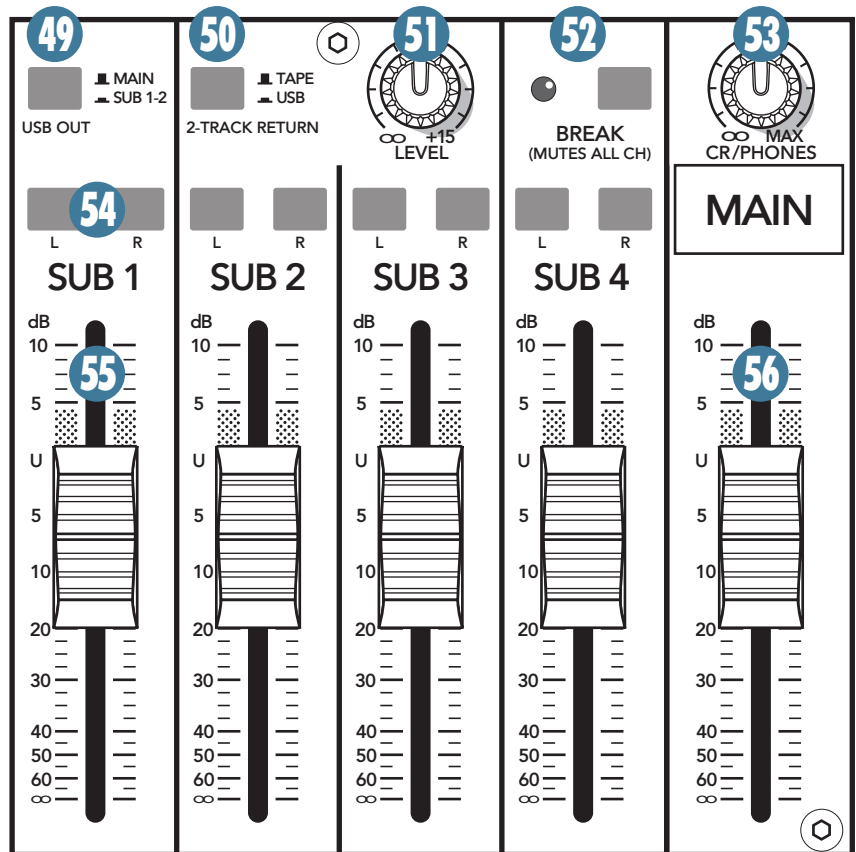

Main & Subs Mix, USB Out, 2-Track Return, and more!

49. USB OUT Switch

This switch allows flexibility on the recordable signals. The default switch configuration (disengaged) allows the main L-R mix to be recorded for convenient stereo mixes of the show. Engaging the switch routes subgroups 1-2 over the USB connection to your favorite DAW software for an alternate 2-track recording.

50. 2-TRACK RETURN TAPE / USB Switch

This determines if the 2-track return gets its signal from the RCA “tape” inputs [34] (switch disengaged) or USB (switch engaged).

51. 2-TRACK RETURN LEVEL

This knob controls the overall level to the mains of the tape (RCA) or USB, depending on the position of the 2-track return tape/USB switch [50]. This knob's level ranges from off, through unity (center detent position), on up to 15 dB of extra gain (fully clockwise).

52. BREAK Switch and LED

This important “take-a-break” switch quickly mutes all the microphones and line-level inputs when the band is between sets. This will prevent protestors or rogue karaoke singers from storming the stage at the interval. The monitor send [26] and FX send [27] are not affected. If there is no sound coming out of the system, be sure to check this switch first. The adjacent break LED will come on as a reminder that the channels are muted.

It is possible to play the stereo RCA tape inputs [34] in the main stereo mix or play audio coming in from the computer via the USB inputs. For example, a soothing CD may be played while the band is off stage.

53. CR/PHONES

As one might expect, this knob controls the levels of both the stereo control room and the headphones. Make sure that this knob is fully off [counter-clockwise] before selecting or adding a new source.

Whatever the selection, the control room outputs may also be used for other applications. The sound quality is just as impeccable as the main outputs. It may be used as an additional main mix output and this one will have its own level control. However, be aware that if a solo switch [22] is engaged, the mix will be interrupted:

When a channel's solo switch [22] is engaged, any existing selection is replaced by the solo signal, appearing at the control room outputs [31], phones [33] and at the left meter [40]. The audible solo levels are then controlled by the control room knob [53]. The solo levels appearing on the meters are not controlled by the control room knob [53] - you would not want that, anyway. What you do want to see is the actual channel level on the meters regardless of how loud the control room and phones output levels might be.



Solo signals reaching the headphones and monitor outputs are not affected by the channel level or main level; therefore, turn down the phones level [53] and monitor level [42] first, as soloed channels may be loud.

54. SUBS ASSIGN Switches

One popular use of the subs is to use them as master faders for a group of channels on their way to the main mix fader [56]. Let us say you have a drum kit hogging up seven channels and you are going to want to control their group volume more conveniently. You do not want to try that with seven hands or seven fingers, so just unassign these channels from the main mix and reassign them to subs 1-2, engage the assign to main mix left on sub 1 and assign to main mix right on sub 2. Now you may ride the entire drum mix with two faders – subs 1 and 2.

If you engage just one assign to main mix button per group (left or right), the signal sent to the main mix fader [56] will be the same level as the sub outs [32]. If you want the subgroup to appear in the center of the main mix, engage both the assign to main mix left and right buttons. The signal will be sent to both sides, and reduced in level by 3 dB like a pan pot, so the overall level is the same, whether the group is assigned to main left, main right, or both.

55. SUB 1-4 FADERS

As you might expect, these faders control the levels of the signals sent to the sub outs [32]. All channels that are assigned to subs, not muted, and not turned fully down will appear at the sub outs.

The sub signal is off when its fader is fully down, the “U” marking is unity gain, and fully up provides 10 dB additional gain. Remember that if you are treating two subs as a stereo pair, sub 1 and 2 for example, make sure that both sub faders “ride” together to maintain the left/right balance.

56. MAIN MIX

This stereo fader allows you to adjust the levels of the main mix signals sent to the XLR and 1/4" main line-level outputs [30] and the tape outputs [34].

This gives you the ultimate feeling of power and control over the sound levels sent to your audience. Adjust this control carefully, with your good eye on the meters to check against overloading, and your good ear to the levels to make sure your audience (if any) is happy.

The main mix signals are off with the fader fully down, the “U” marking is unity gain, and fully up provides 10 dB of additional gain. This additional gain will typically never be needed, but once again, it's nice to know that it's there. The fader is stereo, as it affects both the left and right of the main mix equally. This is the ideal control to slowly bring down at the end of a song (or quickly in the middle of a song if the need ever arises).

This control does not affect the mon send or FX send outputs [26, 27]. This does, however, conclude the main portion of the owner's manual. From here on out it's all appendices.

Appendix A: Service Information

If you think your mixer has a problem, please check out the following troubleshooting tips and do your best to confirm the problem. Visit the Support section of our website (www.mackie.com) where you will find lots of useful information such as FAQs, documentation and any updated PC drivers etc. You may find the answer to the problem without having to send your mixer away.

Troubleshooting

Bad Channel

- Is the channel EQ set up nicely?
- Is the channel gain set correctly?
- Is the channel level up enough?
- Is the channel OL led on?
- Is the channel pan set in the middle?
- Try the same source signal in another channel, set up exactly like the suspect channel.
- Is phantom power required for your microphone?

Bad Output

- Is the main level turned up?
- Are the EQs set to reasonable levels?
- Are any aux returns maxed out?
- Unplug anything from the other line-level outputs, such as monitor out, just in case one of your external pieces has a problem.
- Make sure that you are not overdriving your amplifiers. Check the loudspeaker average load impedance is not less than the minimum your amplifier can handle. Check the speaker wiring.

Noise

- Turn the channel gains down, one by one. If the sound disappears, it's either that channel or whatever is plugged into it, so unplug whatever that is. If the noise disappears, it's from your whatever.

Power

- The power LED should come on if the mixer is connected to a suitable live AC mains outlet, and the power switch is on. Check to make sure that the power cord is securely plugged in.

Repair

For warranty service, refer to the warranty information on page 35.

Non-warranty service for Mackie products is available at a factory-authorized service center. To locate your nearest service center, visit www.mackie.com, click "Support" and select "Locate a Service Center." Service for Mackie products living outside the United States can be obtained through local dealers or distributors.

If you do not have access to our website, you can call our Tech Support department at 1-800-898-3211, Monday-Friday during normal business hours, Pacific Time, to explain the problem. Tech Support will tell you where the nearest factory-authorized service center is located in your area.

Appendix B: Connections

XLR Connectors

Mackie mixers use 3-pin female XLR connectors on all microphone inputs, with pin 1 wired to the grounded (earthed) shield, pin 2 wired to the high (hot or positive polarity) side of the audio signal and pin 3 wired to the low (cold or negative polarity) side of the signal. See Figure A.

Use a male XLR-type connector, usually found on the nether end of what is called a "mic cable," to connect to a female XLR jack.

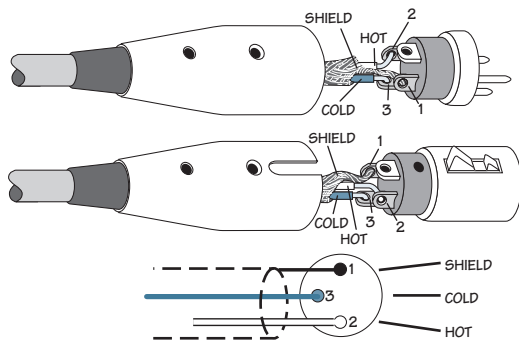

Figure A: XLR Connectors

1/4" TRS Phone Plugs and Jacks

TRS stands for Tip-Ring-Sleeve, the three connections available on a stereo 1/4" or balanced phone jack or plug. See Figure B.

TRS jacks and plugs are used in several different applications:

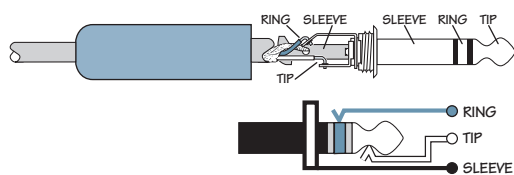

Figure B: TRS Plug

- Balanced mono circuits. When wired as a balanced connector, a 1/4" TRS jack or plug is connected tip to signal high (hot), ring to signal low (cold), and sleeve to ground (earth).
- Stereo headphones, and rarely, stereo microphones and stereo line connections. When wired for stereo, a 1/4" TRS jack or plug is connected tip to left, ring to right and sleeve to ground (earth). Mackie mixers do not directly accept 1-plug-type stereo microphones. They must be separated into a left cord and a right cord, which are plugged into two mic preamps.

- Unbalanced send/return circuits. When wired as send/return "Y" connector, a 1/4" TRS jack or plug is connected tip to signal send (output from mixer), ring to signal return (input back into mixer), and sleeve to ground (earth).

1/4" TS Phone Plugs and Jacks

TS stands for Tip-Sleeve, the two connections available on a mono 1/4" phone jack or plug. See Figure C.

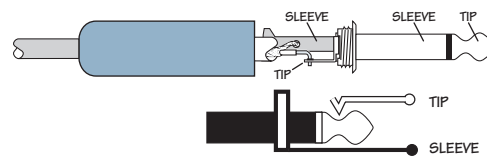

Figure C: TS Plug

TS jacks and plugs are used in many different applications, always unbalanced. The tip is connected to the audio signal and the sleeve to ground (earth). Some examples:

- Unbalanced microphones
- Electric guitars and electronic instruments
- Unbalanced line-level connections
- Speaker connections



Don't use guitar cords for speaker cables! They're not designed to handle speaker-level signals and could overheat.

RCA Plugs and Jacks

RCA-type plugs (also known as phono plugs) and jacks are often used in home stereo and video equipment and in many other applications (Figure D). They are unbalanced and electrically identical to a 1/4" TS phone plug or jack. See Figure C. Connect the signal to the center post and the ground (earth) or shield to the surrounding "basket."



Figure D: RCA Plug

Figure E: Does not appear in this owner's manual, due to a contractual obligation, but performs nightly at the downtown Woodinville Cocoa Rooms and Tea Bar

TRS Send/Receive Insert Jacks

Mackie's single-jack inserts are the three-conductor, TRS 1/4" phone type. They are unbalanced, but have both the mixer output (send) and the mixer input (return) signals in one connector. See Figure F.

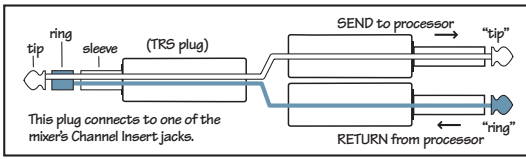

Figure F

The sleeve is the common ground (earth) for both signals. The send from the mixer to the external unit is carried on the tip, and the return from the unit to the mixer is on the ring.

Using the Send-only on an Insert Jack

If you insert a TS (mono) 1/4" plug only partially (to the first click) into a Mackie insert jack, the plug will not activate the jack switch and will not open the insert loop in the circuit (thereby allowing the channel signal to continue on its merry way through the mixer).

This allows you to tap out the channel signal without interrupting normal operation.

If you push the 1/4" TS plug in to the second click, you will open the jack switch and create a direct out, which does interrupt the signal in that channel. See Figure G.

NOTE: Do not overload or short-circuit the signal you are tapping from the mixer. That will affect the internal signal.

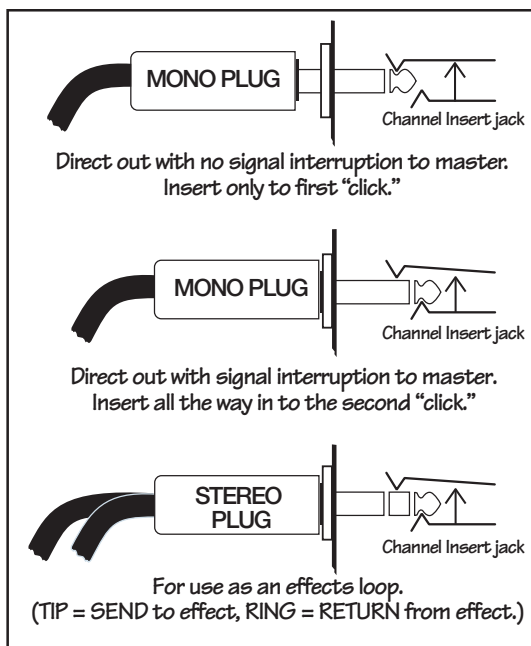

Figure G

Appendix C: Technical Information

Specifications

Noise Characteristics:

(20 Hz to 20 kHz bandwidth, 150 Ω Source Impedance Equivalent Input Noise)	
Mic in to Insert Send out, max gain (Residual Output Noise)	-128.0 dBu
All outputs, master levels off, all channel levels off	-95 dBu
All outputs, master levels unity, all channel levels off	-85 dBu
All outputs, master levels unity, 1 channel level unity	-85 dBu

Frequency Response:

(Mic input to any output, gain at unity)	
20 Hz to 40 kHz	+0 dB / -1 dB

Distortion (THD+N):

(20 Hz to 20 kHz bandwidth)	
Mic in to Main Out	<0.01% @ +4 dBu output

Attenuation and Crosstalk:

(20 Hz to 20 kHz bandwidth)	
Adjacent Inputs @ 1 kHz	-90 dBu
Fader Off @ 1 kHz	-75 dBu
Mute Switch/Break Switch Mute @ 1 kHz	-100 dBu

Common Mode Rejection Ratio (CMRR):

(Mic in to Main out, channel gain at max: 50 dB)	
@1 kHz	70 dB

Maximum Levels:

All inputs	+22 dBu
Main Mix XLR	+28 dBu
All other outputs	+22 dBu

3-Band Equalization (mono channels)

Low	±15 dB @ 80 Hz
Mid	±15 dB sweep 100 Hz-8 kHz
High	±15 dB @ 12 kHz
Low Cut Filter	18 dB/octave, -3 dB @ 100 Hz

4-Band Equalization (stereo channels)

Low	±15 dB @ 80 Hz
Mid	±15 dB @ 2.5 kHz
High	±15 dB @ 12 kHz

USB

Format	USB 1.1
I/O	Stereo Input, Stereo Output
A/D/A	16 bit, 44.1 kHz / 48 kHz

Input and Output Impedance:

Mic in	3.3 kΩ
Channel Insert return	10 kΩ
All other inputs	20 kΩ
Tape out	1 kΩ
Phones out	25 Ω
All other outputs	120 Ω

AC Power Requirements:

Power Consumption	40 watts (ProFX16) 45 watts (ProFX22)
Universal AC Power Supply	100 VAC - 240 VAC, 50 - 60 Hz
Power Connector	3 Pin IEC

Physical Dimensions and Weight

Front Height	1.7 in / 44 mm (both)
Rear Height	3.8 in / 97 mm (both)
Depth	16.0 in / 407 mm (both)
Width	18.7 in / 475 mm (ProFX16) 25.1 in / 639 mm (ProFX22)
Weight	13 lb / 5.9 kg (ProFX16) 18 lb / 8.2 kg (ProFX22)

LOUD Technologies Inc. is always striving to improve our products by incorporating new and improved materials, components, and manufacturing methods. Therefore, we reserve the right to change these specifications at any time without notice.

“Mackie,” and the “Running Man” are registered trademarks of LOUD Technologies Inc. All other brand names mentioned are trademarks or registered trademarks of their respective holders, and are hereby acknowledged.

Please check our website for any updates to this manual:
www.mackie.com.

©2011 LOUD Technologies Inc. All Rights Reserved.

Dimensions

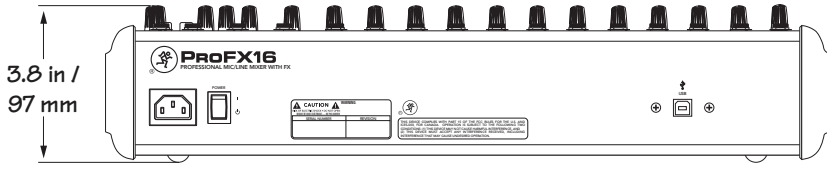



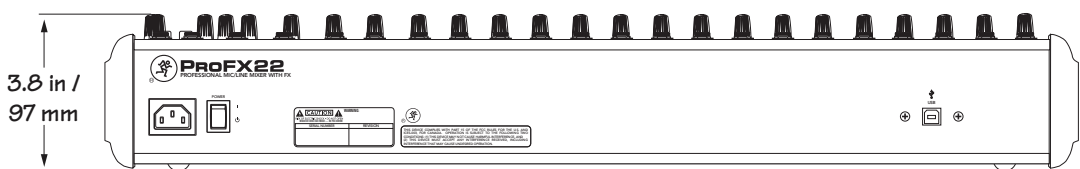
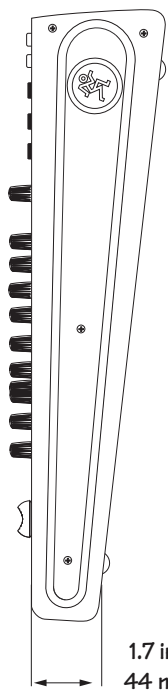
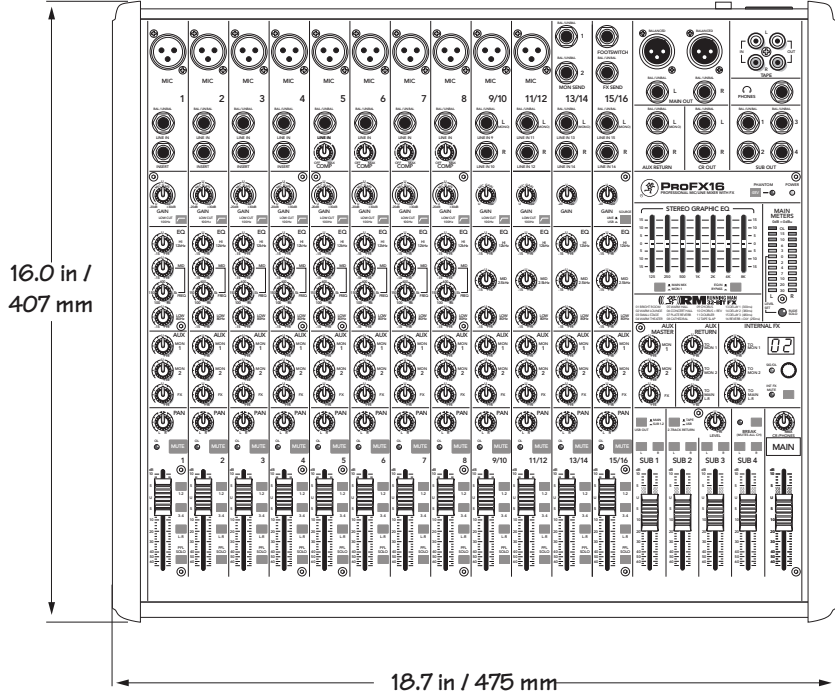



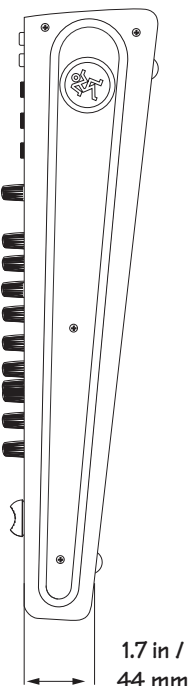
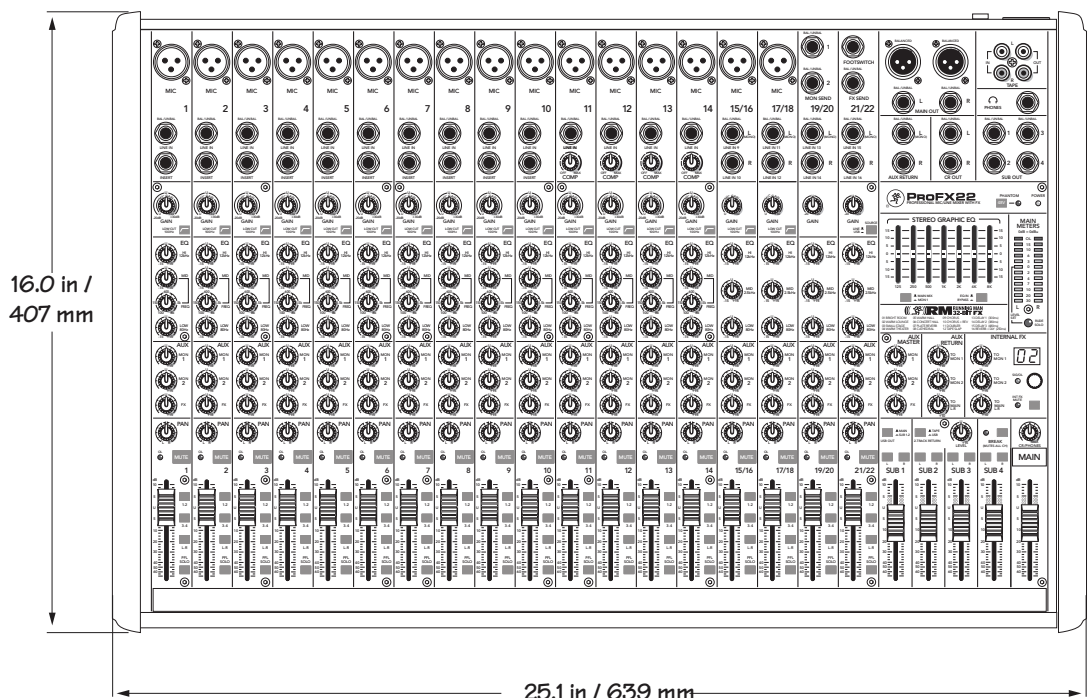









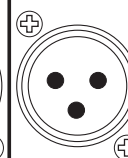













WEIGHT
13 lb
5.9 kg



WEIGHT
18 lb
8.2 kg

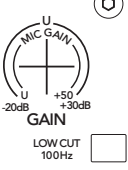
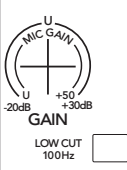
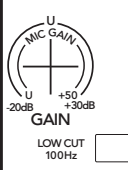
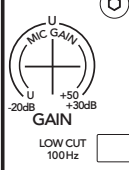
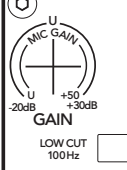
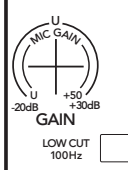
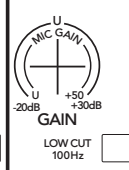
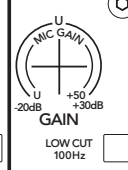
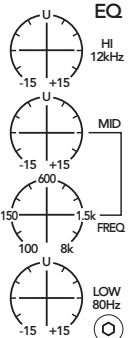
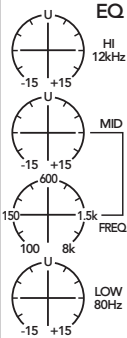
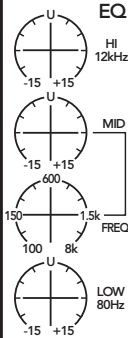
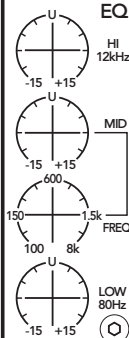
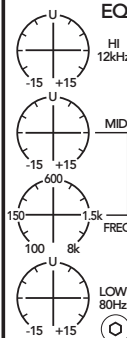
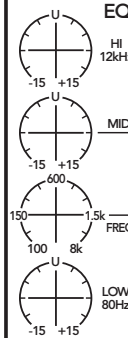
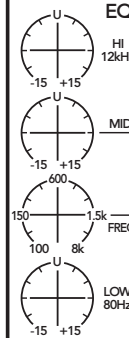
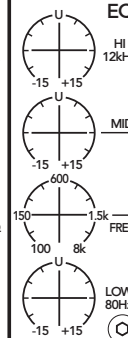
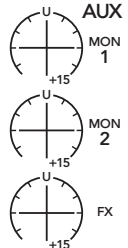
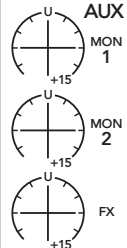
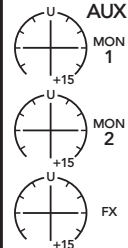
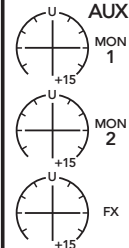
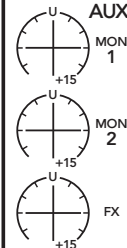
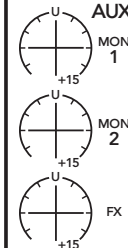
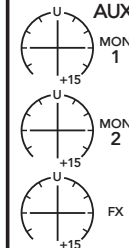
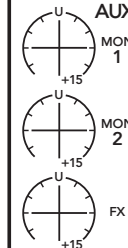
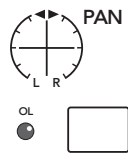
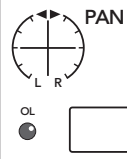
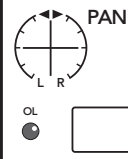
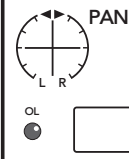
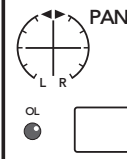
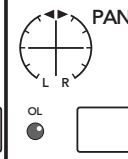
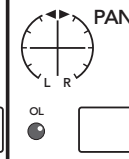
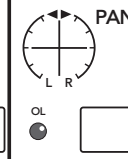
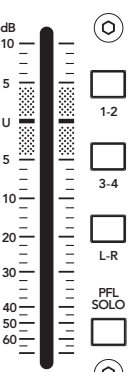
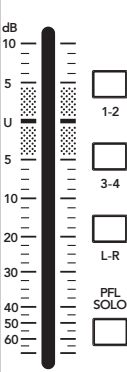
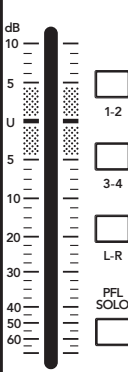
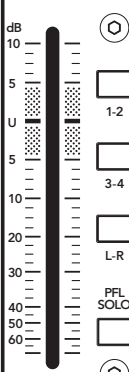
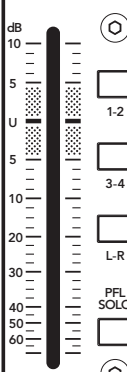
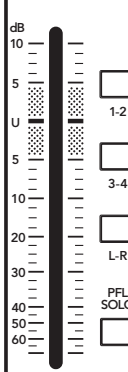
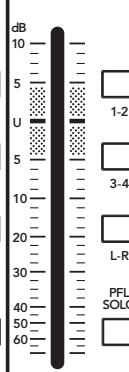
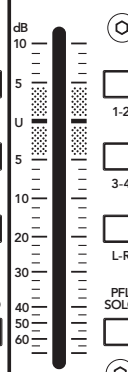

Track Sheet - Mono Channels

 MIC	 MIC	 MIC	 MIC	 MIC	 MIC	 MIC	 MIC
 BAL/UNBAL	 BAL/UNBAL	 BAL/UNBAL	 BAL/UNBAL	 BAL/UNBAL	 BAL/UNBAL	 BAL/UNBAL	 BAL/UNBAL
 LINE IN	 LINE IN	 LINE IN	 LINE IN	 LINE IN	 LINE IN	 LINE IN	 LINE IN
 INSERT	 INSERT	 INSERT	 INSERT	 INSERT	 INSERT	 INSERT	 INSERT
 MIC GAIN LOW CUT 100Hz <input type="checkbox"/>	 MIC GAIN LOW CUT 100Hz <input type="checkbox"/>	 MIC GAIN LOW CUT 100Hz <input type="checkbox"/>	 MIC GAIN LOW CUT 100Hz <input type="checkbox"/>	 MIC GAIN LOW CUT 100Hz <input type="checkbox"/>	 MIC GAIN LOW CUT 100Hz <input type="checkbox"/>	 MIC GAIN LOW CUT 100Hz <input type="checkbox"/>	 MIC GAIN LOW CUT 100Hz <input type="checkbox"/>
 EQ HI 12kHz MID LOW 80Hz	 EQ HI 12kHz MID LOW 80Hz	 EQ HI 12kHz MID LOW 80Hz	 EQ HI 12kHz MID LOW 80Hz	 EQ HI 12kHz MID LOW 80Hz	 EQ HI 12kHz MID LOW 80Hz	 EQ HI 12kHz MID LOW 80Hz	 EQ HI 12kHz MID LOW 80Hz
 AUX MON 1 MON 2 FX	 AUX MON 1 MON 2 FX	 AUX MON 1 MON 2 FX	 AUX MON 1 MON 2 FX	 AUX MON 1 MON 2 FX	 AUX MON 1 MON 2 FX	 AUX MON 1 MON 2 FX	 AUX MON 1 MON 2 FX
 PAN OL <input type="checkbox"/>	 PAN OL <input type="checkbox"/>	 PAN OL <input type="checkbox"/>	 PAN OL <input type="checkbox"/>	 PAN OL <input type="checkbox"/>	 PAN OL <input type="checkbox"/>	 PAN OL <input type="checkbox"/>	 PAN OL <input type="checkbox"/>
 dB U 1-2 3-4 L-R PFL SOLO	 dB U 1-2 3-4 L-R PFL SOLO	 dB U 1-2 3-4 L-R PFL SOLO	 dB U 1-2 3-4 L-R PFL SOLO	 dB U 1-2 3-4 L-R PFL SOLO	 dB U 1-2 3-4 L-R PFL SOLO	 dB U 1-2 3-4 L-R PFL SOLO	 dB U 1-2 3-4 L-R PFL SOLO

Track Sheet - Comp & Stereo Channels

MIC	MIC	MIC	MIC	MIC	MIC	MON SEND	FX SEND
LINE IN	LINE IN	LINE IN	LINE IN	LINE IN 9	LINE IN 11	LINE IN 13	LINE IN 15
OFF MAX	OFF MAX	OFF MAX	OFF MAX	OFF MAX	OFF MAX	OFF MAX	OFF MAX
MIC GAIN	MIC GAIN	MIC GAIN	MIC GAIN	MIC GAIN	MIC GAIN	MIC GAIN	MIC GAIN
LOW CUT 100Hz	LOW CUT 100Hz	LOW CUT 100Hz	LOW CUT 100Hz	LOW CUT 100Hz	LOW CUT 100Hz	LOW CUT 100Hz	LOW CUT 100Hz
EQ	EQ	EQ	EQ	EQ	EQ	EQ	EQ
AUX	AUX	AUX	AUX	AUX	AUX	AUX	AUX
PAN	PAN	PAN	PAN	PAN	PAN	PAN	PAN
OL	OL	OL	OL	OL	OL	OL	OL
dB	dB	dB	dB	dB	dB	dB	dB
SOLO	SOLO	SOLO	SOLO	SOLO	SOLO	SOLO	SOLO

Track Sheet - Master Section

PHANTOM
 POWER

Appendix D: Table of Effects Presets

No.	Title	Description	Example of its use
01	Bright Room	This room has a bright tone with lots of scattered reflections to simulate harder, more reflective surfaces.	Useful on vocals that require a brighter reverb to cut through the mix, or for giving acoustic instruments a livelier vibe.
02	Warm Lounge	This preset features a medium sized room sound, with just enough enhancement of the lower mids to produce a warm tone.	Useful for vocals on songs that require a larger, more "wet" sound, or for giving dimension to bright horns without adding harshness.
03	Small Stage	This preset simulates the sound of a small concert stage, with a medium reverb time and reverberant space.	Useful for vocals or guitars in fast paced, high-energy songs that call for a "live" sounding reverberation.
04	Warm Theater	This reverb has a warm bodied tone and medium long reverb time to simulate the live acoustics of a theater space.	Perfect for vocals, drums, acoustic and electric guitars, keyboards and more.
05	Warm Hall	This reverb simulates the sound of a spacious, yet cozy, heavily draped and carpeted concert hall with an especially warm tone.	Perfect for adding natural concert hall ambience to close-mic'ed orchestral instruments.
06	Concert Hall	This hall reverb is characterized by its large, spacious sound, long pre-delay, and vibrant tone.	Adds life to acoustic instruments and vocals from solos to full-on symphonies and choirs.
07	Plate Reverb	This preset emulates vintage mechanical reverberation that was generated with a metal plate. Its sound is characterized by lots of early reflections and no pre-delay.	Perfect for thickening percussive instruments, such as a snare drum, or tight vocal arrangements.
08	Cathedral	This reverb emulates the extremely long tails, dense diffusion and long pre-delays and reflections that would be found in a very large, stone walled house of worship.	Gives amazing depth to choirs, wind instruments, organs and soft acoustic guitars.
09	Chorus	This preset provides a soft, ethereal sweeping effect that is useful for thickening and for making a particular sound pop out of the mix.	Perfect for enhancement of electric and acoustic guitar and bass, or to add a dramatic effect to vocals, particularly group harmonies and choirs.
10	Chorus + Reverb	This preset perfectly combines the chorus effect above with a large, roomy reverb.	This effect thickens the sound with chorus while adding warmth and spaciousness thanks to the smooth reverb.
11	Doubler	This effect simulates the sound of a vocal or instrument being recorded twice (double-tracked) on a multi-track recorder.	Provides a vibe that is similar to chorus without the subtle swirl.
12	Tape Slap	This effect provides a single, relatively rapid delay of the original signal, with the added warmth that vintage tape-based echo units provided.	Often used on vocals for a 1950's era feel, or on guitars for a surf-type tone. Often used by people whose favorite number is 12.
13 14 15	DLY 1 (300ms) DLY 2 (380ms) DLY 3 (480ms)	These three presets provide delay. The default delay time for each preset is shown in ms – the smaller the time, the faster the delay.	These work best with full, up-beat music like rock where the delay needs to cut through the mix.
16	Reverb + DLY (250ms)	This effect combines the Warm Theater reverb effect with the echoes of the 3-repeat delay effect.	Perfect for thickening vocals while adding dimensions, it can also be used as a spacey effect on electric guitars.

ProFX16 and ProFX22 Limited Warranty

Please keep your sales receipt in a safe place.

This Limited Product Warranty ("Product Warranty") is provided by LOUD Technologies Inc. ("LOUD") and is applicable to products purchased in the United States or Canada through a LOUD-authorized reseller or dealer. The Product Warranty will not extend to anyone other than the original purchaser of the product (hereinafter, "Customer," "you" or "your").

For products purchased outside the U.S. or Canada, please visit www.mackie.com/warranty to find contact information for your local distributor, and information on any warranty coverage provided by the distributor in your local market.

LOUD warrants to Customer that the product will be free from defects in materials and workmanship under normal use during the Warranty Period. If the product fails to conform to the warranty then LOUD or its authorized service representative will at its option, either repair or replace any such nonconforming product, provided that Customer gives notice of the noncompliance within the Warranty Period to the Company at: www.mackie.com/support or by calling LOUD technical support at 1.800.898.3211 (toll-free in the U.S. and Canada) during normal business hours Pacific Time, excluding weekends or LOUD holidays. Please retain the original dated sales receipt as evidence of the date of purchase. You will need it to obtain any warranty service.

For full terms and conditions, as well as the specific duration of the Warranty for this product, please visit www.mackie.com/warranty.

The Product Warranty, together with your invoice or receipt, and the terms and conditions located at www.mackie.com/warranty constitutes the entire agreement, and supersedes any and all prior agreements between LOUD and Customer related to the subject matter hereof. No amendment, modification or waiver of any of the provisions of this Product Warranty will be valid unless set forth in a written instrument signed by the party to be bound thereby.

Need help with your mixer?

- Visit www.mackie.com and click Support to find: FAQs, manuals, addendums, and other useful information.
- Email us at: techmail@mackie.com.
- Telephone 1-800-898-3211 to speak with one of our splendid technical support chaps (Monday through Friday, normal business hours, Pacific Time).

MACKIE®

16220 Wood-Red Road NE • Woodinville, WA 98072 • USA

United States and Canada: 800.898.3211

Europe, Asia, Central and South America: 425.487.4333

Middle East and Africa: 31.20.654.4000

Fax: 425.487.4337 • www.mackie.com

E-mail: sales@mackie.com

Free Manuals Download Website

<http://myh66.com>

<http://usermanuals.us>

<http://www.somanuals.com>

<http://www.4manuals.cc>

<http://www.manual-lib.com>

<http://www.404manual.com>

<http://www.luxmanual.com>

<http://aubethermostatmanual.com>

Golf course search by state

<http://golfingnear.com>

Email search by domain

<http://emailbydomain.com>

Auto manuals search

<http://auto.somanuals.com>

TV manuals search

<http://tv.somanuals.com>