

CR3™ • CR4™

Creative Reference™ Multimedia Monitors

OWNER'S MANUAL



Important Safety Instructions

1. Read these instructions.
2. Keep these instructions.
3. Heed all warnings.
4. Follow all instructions.
5. Do not use this apparatus near water.
6. Clean only with a dry cloth.
7. Do not block any ventilation openings. Install in accordance with the manufacturer's instructions.
8. Do not install near any heat sources such as radiators, heat registers, stoves, or other apparatus (including amplifiers) that produce heat.
9. Do not defeat the safety purpose of the polarized or grounding-type plug. A polarized plug has two blades with one wider than the other. A grounding-type plug has two blades and a third grounding prong. The wide blade or the third prong are provided for your safety. If the provided plug does not fit into your outlet, consult an electrician for replacement of the obsolete outlet.
10. Protect the power cord from being walked on or pinched particularly at plugs, convenience receptacles, and the point where they exit from the apparatus.
11. Only use attachments/accessories specified by the manufacturer.
12. Use only with a cart, stand, tripod, bracket, or table specified by the manufacturer, or sold with the apparatus. When a cart is used, use caution when moving the cart/apparatus combination to avoid injury from tip-over.
13. Unplug this apparatus during lightning storms or when unused for long periods of time.
14. Refer all servicing to qualified service personnel. Servicing is required when the apparatus has been damaged in any way, such as power-supply cord or plug is damaged, liquid has been spilled or objects have fallen into the apparatus, the apparatus has been exposed to rain or moisture, does not operate normally, or has been dropped.
15. This apparatus shall not be exposed to dripping or splashing, and no object filled with liquids, such as vases or beer glasses, shall be placed on the apparatus.
16. Do not overload wall outlets and extension cords as this can result in a risk of fire or electric shock.
17. This apparatus has been equipped with a rocker-style AC mains power switch. This switch is located on the rear panel and should remain readily accessible to the user.
18. The MAINS plug or an appliance coupler is used as the disconnect device, so the disconnect device shall remain readily operable.

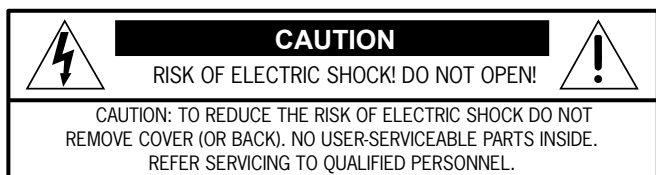

The lightning flash with arrowhead symbol within an equilateral triangle is intended to alert the user to the presence of uninsulated "dangerous voltage" within the product's enclosure, that may be of significant magnitude to constitute a risk of electric shock to persons.



The exclamation point within an equilateral triangle is intended to alert the user of the presence of important operating and maintaining (servicing) instructions in the literature accompanying the appliance.

19. NOTE: This equipment has been tested and found to comply with the limits for a Class B digital device, pursuant to part 15 of the FCC Rules. These limits are designed to provide reasonable protection against harmful interference in a residential installation. This equipment generates, uses, and can radiate radio frequency energy and, if not installed and used in accordance with the instructions, may cause harmful interference to radio communications. However, there is no guarantee that interference will not occur in a particular installation. If this equipment does cause harmful interference to radio or television reception, which can be determined by turning the equipment off and on, the user is encouraged to try to correct the interference by one or more of the following measures:

- Reorient or relocate the receiving antenna.
- Increase the separation between the equipment and the receiver.
- Connect the equipment into an outlet on a circuit different from that to which the receiver is connected.
- Consult the dealer or an experienced radio/TV technician for help.

CAUTION: Changes or modifications to this device not expressly approved by LOUD Technologies Inc. could void the user's authority to operate the equipment under FCC rules.

20. This apparatus does not exceed the Class A/Class B (whichever is applicable) limits for radio noise emissions from digital apparatus as set out in the radio interference regulations of the Canadian Department of Communications.

ATTENTION — *Le présent appareil numérique n'émet pas de bruits radioélectriques dépassant les limites applicables aux appareils numériques de class A/de class B (selon le cas) prescrites dans le règlement sur le brouillage radioélectrique édicté par les ministere des communications du Canada.*

21. Exposure to extremely high noise levels may cause permanent hearing loss. Individuals vary considerably in susceptibility to noise-induced hearing loss, but nearly everyone will lose some hearing if exposed to sufficiently intense noise for a period of time. The U.S. Government's Occupational Safety and Health Administration (OSHA) has specified the permissible noise level exposures shown in the following chart.

According to OSHA, any exposure in excess of these permissible limits could result in some hearing loss. To ensure against potentially dangerous exposure to high sound pressure levels, it is recommended that all persons exposed to equipment capable of producing high sound pressure levels use hearing protectors while the equipment is in operation. Ear plugs or protectors in the ear canals or over the ears must be worn when operating the equipment in order to prevent permanent hearing loss if exposure is in excess of the limits set forth here:

Duration, per day in hours	Sound Level dBA, Slow Response	Typical Example
8	90	Duo in small club
6	92	
4	95	Subway Train
3	97	
2	100	Very loud classical music
1.5	102	
1	105	Matt screaming at Troy about deadlines
0.5	110	
0.25 or less	115	Loudest parts at a rock concert

WARNING — To reduce the risk of fire or electric shock, do not expose this apparatus to rain or moisture.

Laite on liitettävä suojakoskettimilla varustettuun pistorasiaan.

Apparatet må tilkoples jordet stikkontakt.

Apparaten skall anslutas till jordat uttag.



Correct disposal of this product: This symbol indicates that this product should not be disposed of with your household waste, according to the WEEE directive (2012/19/EU) and your national law. This product should be handed over to an authorized collection site for recycling waste electrical and electronic equipment (EEE). Improper handling of this type of waste could have a possible negative impact on the environment and human health due to potentially hazardous substances that are generally associated with EEE. At the same time, your cooperation in the correct disposal of this product will contribute to the effective usage of natural resources. For more information about where you can drop off your waste equipment for recycling, please contact your local city office, waste authority, or your household waste disposal service.

Contents

- Important Safety Instructions.....2
- Contents3
- Features3
- Introduction4
- How To Use This Manual.....4
- Quick Start.....4
- Additional Tidbits of Wisdom.....4
- Hookup Diagrams5
- Rear Panel Description7
 - 1. AC Line Cord.....7
 - 2. Power Switch.....7
 - 3. Signal Inputs7
 - 4. Powered Speaker Position Select Switch.....8
 - 5. Wire Terminals (±).....8
 - 6. Custom-Tuned Rear Port.....8
- Front Panel Description8
 - 7. Aux Input8
 - 8. Phones Output8
 - 9. Volume Knob.....8
- Input Signal Wiring9
- Care And Cleaning.....9
- Appendix A: Service Information10
- Appendix B: Technical Information12
 - CR Series Specifications12
 - CR Series Dimensions.....13
 - CR Series Block Diagram14
- CR Series Limited Warranty15

Please write your serial number here for future reference (i.e., insurance claims, tech support, return authorization, make dad proud, etc.)

Purchased at:

Date of purchase:

CR3 • CR4 Features

- Studio-quality design, sound and performance, ideal for multimedia creation and entertainment
- Professional-grade components for optimized sonic performance
 - 50 watts of clean, articulate stereo sound
 - Polypropylene-coated woofer
 - 3" [CR3]
 - 4" [CR4]
 - .75" Ferrofluid-cooled silk-dome tweeter
- Ultra-wide frequency range, perfect for full-range multimedia
 - 80 Hz – 20 kHz [CR3]
 - 70 Hz – 20 kHz [CR4]
- Choose which side of the desk gets the volume knob with the convenient speaker placement switch
- Convenient front panel volume knob with lit power ring gives you on/off/volume control and power indication where you need it
- Plug your smart phone (or other source) right into the front of the speakers and listen instantly
- Front-facing headphone jack auto-defeats speaker output and provides tactile headphone volume control
- A choice of inputs for simple connection to almost any audio source: 1/4", 1/8", RCA
- Smooth waveguide design delivers unmatched clarity and sound dispersion at all listening levels
- Custom-tuned rear ports for smooth, even bass extension
- All-wood cabinet provides a natural sonic character superior to low-grade plastic designs
- Included accessories:
 - Acoustic isolation pads minimize boomy bass build-up and provide up/down tilt control for more focused listening
 - 1/8" to stereo RCA cable to connect computer output to speakers
 - 1/8" to 1/8" cable to connect a smart phone or media player to front panel of speakers
 - Speaker-to-speaker cable



Like us



Follow us



Watch our dang videos

Introduction

Creative Reference™ Multimedia Monitors are designed for multimedia creation and entertainment, delivering studio-quality design and performance in sleek, small-footprint designs.

Featuring 50 watts of power and premium components like a sound-enhancing high-frequency waveguide, Creative Reference monitors ensure pristine, accurate sound for any application.

Choose which side of your desk gets the volume knob with CR's speaker placement switch and take advantage of convenient front-panel features like a dedicated input for smartphone playback. Plus, you get all the cables and acoustic isolation pads you need to get started right out of the box.

With these Creative Reference monitors, you get professional sound quality and features in compact desk-friendly designs perfect for work, play and everything in between.

How to Use This Manual

After this introduction, a getting started guide will help you get things set up fast. The hookup diagrams show some typical setups, while the remaining sections provide details of the CR3 and CR4 monitors.



This icon marks information that is critically important or unique to these monitors. For your own good (and our peace of mind), please read and remember them. You will be quizzed later.

Quick Start

We realize that you can't wait to hook up your CR Creative Reference Multimedia Monitors and try them out. Nevertheless, please take the time to read this page NOW, and the rest can wait until you're good and ready.

1. Turn the volume control on the front of the powered CR monitor down (fully counterclockwise) before turning the unit on for the first time.
2. Set the power switch on the back panel off. This will prevent you from accidentally connecting a hot signal source to the monitor and getting a rude surprise.
3. Connect the line-level monitor signal from your computer, mixer, or other signal source to the input jacks on the rear panel of the Creative Reference Monitor (1/4" or RCA).
4. Connect the black (–) and red (+) speaker wires from the powered monitor's ± spring clips to the passive monitor's ± spring clips.
5. Connect the affixed line cord into an AC outlet. The monitor may accept the appropriate voltage as indicated on the back panel.
6. Turn the computer, mixer or other signal source on.
7. Turn on the power switch on the rear panel of the CR monitor.
8. Turn the front panel volume control clockwise until the monitor "clicks" on and the greatest of all Rings of Power – the One Ring – surrounding the volume knob illuminates.
9. Play an audio file and slowly turn the front panel volume control to a comfortable listening level.

If you desire a more thorough walk-through of your CR monitors, there is a wealth of information in the following pages!

Additional Tidbits of Wisdom

- Never listen to loud music for prolonged periods. Please see the Safety Instructions on page 2 for information on hearing protection.
- When you shut down your equipment, turn off the monitors first to prevent thumps and other noises generated by any upstream equipment from coming out the speakers. When powering up, turn on the monitors last.
- Save the sales receipt and original packaging in case you ever need warranty service. See page 15 for details.

Hookup Diagrams

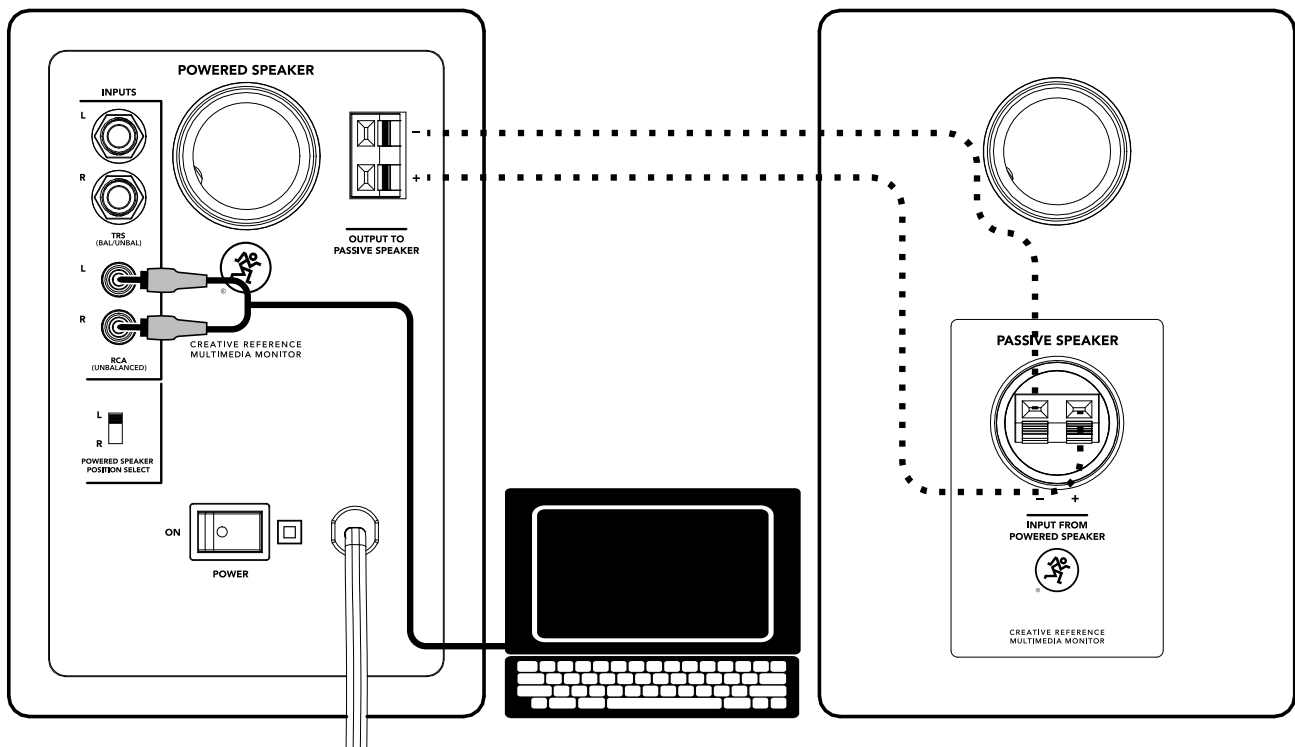

The illustration above shows a typical use for CR Series Reference Monitors. Everyone needs tunes while working, right...or is it just me?

In this example, simply connect the (included) cable from the computer's 1/8" output jack to the L/R RCA inputs of the powered CR Series Reference Monitor. If you prefer to use 1/4" inputs instead of RCA inputs, that option is available, too.

Next we'll want to connect the passive speaker. The included black (-) and red (+) speaker wires should be connected from the powered monitor's ± spring clips to the passive monitor's ± spring clips as detailed by the dotted lines above:

Connect black (-) to black (-) and red (+) to red (+).

Almost there! Move the 'Powered Speaker Position Select' switch to either the "L" or "R" position based on whether the powered reference monitor – the one with the volume knob – will be on the left or right side.

Now position the monitors where you would like them. Play audio through the computer, making sure that the volume of the computer and monitors are above "0".

Last step: move the monitors around until the optimal sound has been achieved and adjust volume to taste.

Optional: place the included acoustic isolation pads underneath the monitors to minimize boomy bass build-up and provide up/down tilt control for more focused listening.

Hookup Diagrams continued...

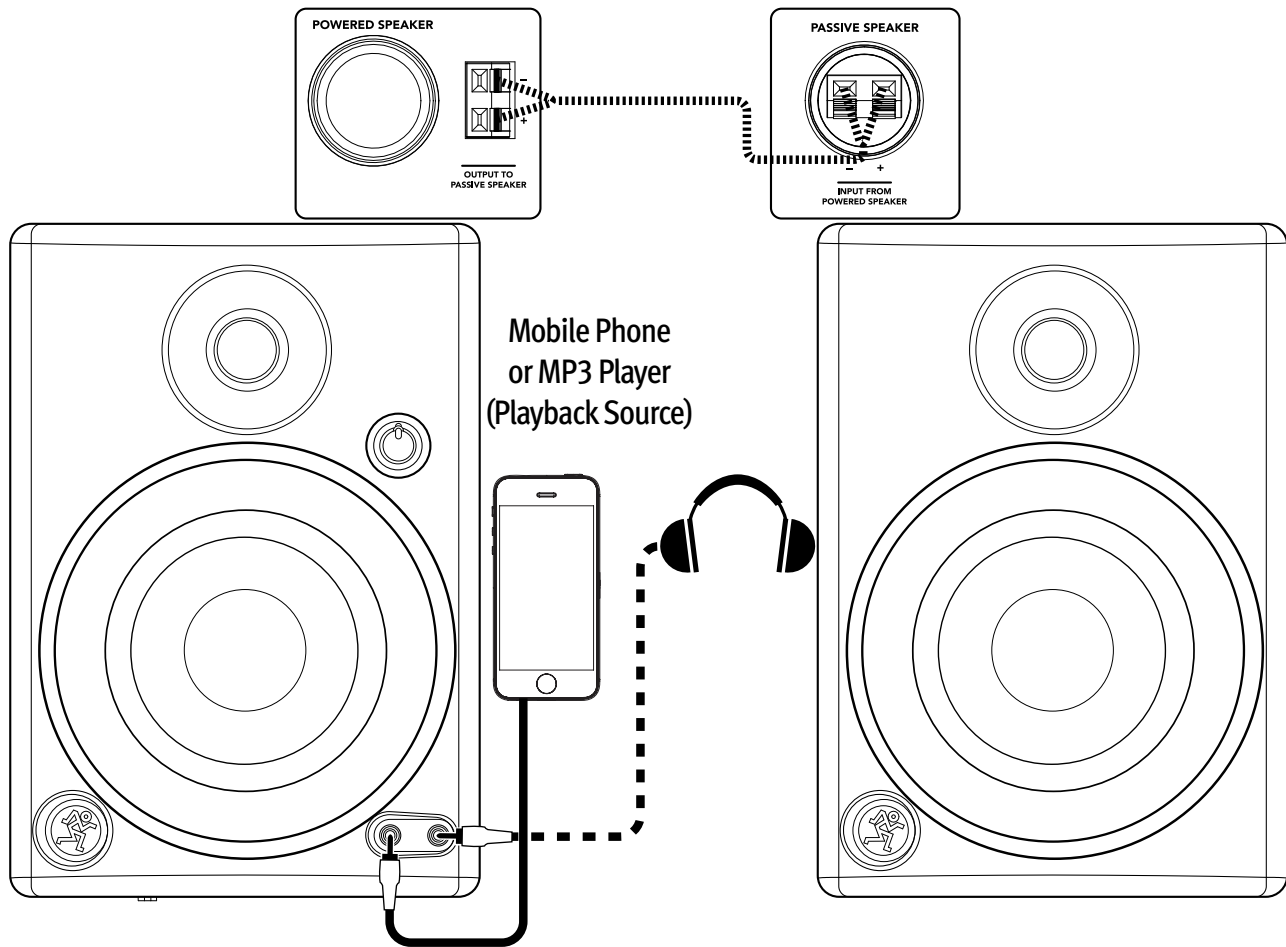

The illustration above shows another use for CR Series Reference Monitors. Perhaps a friend created a playlist on their smart phone and wants to share it. With great hesitation, you finally oblige. Everyone has that one friend with terrible taste in music. We know, it happens.

In this example, simply connect the (included) cable from the smart phone's output/headphone 1/8" jack to the 1/8" aux input on the front panel of the powered CR Series Reference Monitor.

Next we'll want to connect the passive speaker. The included black (-) and red (+) speaker wires should be connected from the powered monitor's \pm spring clips to the passive monitor's \pm spring clips as detailed by the dotted lines above:

Connect black (-) to black (-) and red (+) to red (+).

Almost there! Move the 'Powered Speaker Position Select' switch to either the "L" or "R" position based on whether the powered reference monitor – the one with the volume knob – will be on the left or right side.

Now position the monitors where you would like them. Play audio through the smart phone making sure that the volume of the smart phone and monitors are above "0".

Last step: move the monitors around until the optimal sound has been achieved and adjust volume to taste.

Optional: plugging a pair of headphones into the 1/8" headphones jack auto-defeats the speaker output. The front panel volume control then controls the level going to the phones.

Rear Panel Description

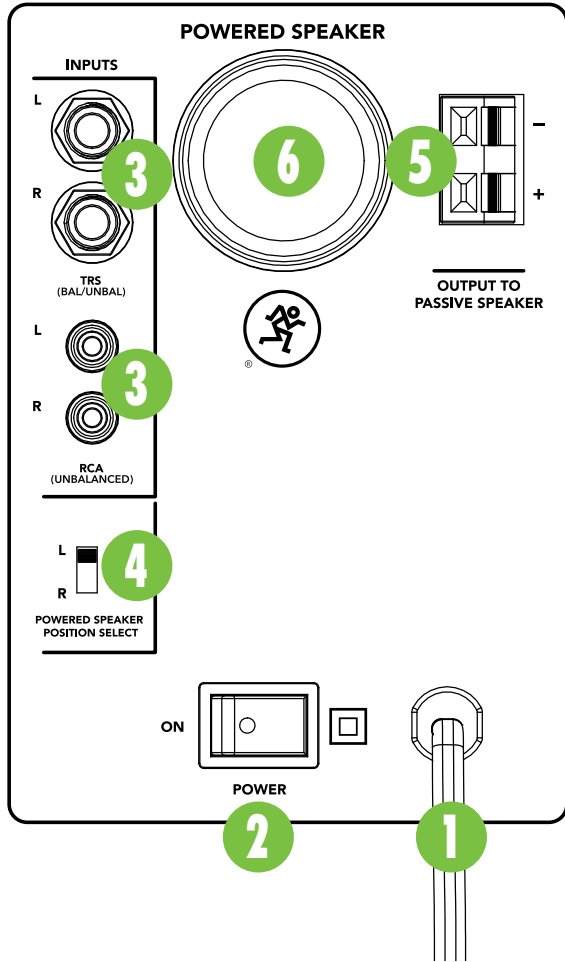

1. AC Line Cord

Plug the attached power cord into a live AC outlet that has the correct voltage indicated on the rear panel.

2. Power Switch

Press this switch left to turn the CR reference monitors on. Make sure the volume knob [9] is off [fully counter-clockwise] before turning it on. The ring surrounding the volume knob illuminates when the CR reference monitor is plugged into an AC outlet, the power switch is turned on and the front panel volume control is turned clockwise until the monitor “clicks” on.

Press the right side of this switch down to put the monitors into standby mode. They will not function, but the circuits are still live. To remove AC power, either turn off the AC supply, or unplug the power cord from the AC supply.

3. Signal Inputs

Connect the line-level signal from a computer, mixer, or other signal source to one pair of these input jacks. There are two types of input connectors to choose from: 1/4" line-level signals driven by balanced or unbalanced sources or RCA line-level signals driven by unbalanced sources. Since these are connected together electrically, do not connect more than one signal at a time to the input jacks.

A balanced signal provides better noise rejection and is the preferred method, especially if using a cable longer than 20 feet (6 meters).

They are wired as follows, according to standards specified by the AES (Audio Engineering Society):

Balanced 1/4" TRS

Hot (+)	Tip
Cold (-)	Ring
Shield (Ground)	Sleeve

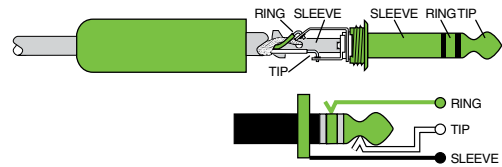

Balanced 1/4" Connectors

Unbalanced 1/4" TS

Hot (+)	Tip
Shield (Ground)	Sleeve

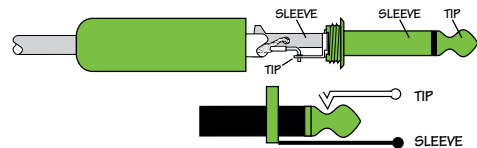

Unbalanced 1/4" Connectors

Unbalanced RCA

Hot (+)	Tip
Shield (Ground)	Sleeve

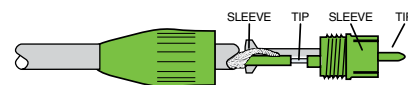

RCA Unbalanced Connectors

4. Powered Speaker Position Select Switch

Here you get to decide if the powered monitor is to be positioned on the left side (switch up) or right side (switch down) of the desk. One convenience is that it keeps the power cord, front and/or rear panel connections from crossing your work space. Additionally, it doesn't discriminate between right or left-handed users. Simply set it up to suit your preference.

5. Wire Terminals (±)

Connect the included black (-) and red (+) speaker wires from the powered monitor's ± spring clips [big green ball number 5 on page 6] to the passive monitor's ± spring clips (as seen to the right).

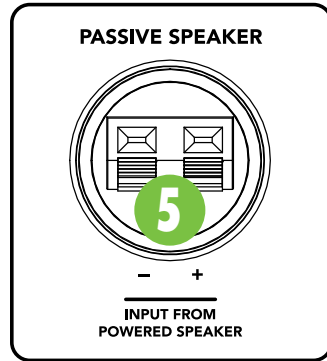

6. Custom-Tuned Rear Port

The custom-tuned rear port uses the radiation from the rear of the woofer cone to extend the low-frequency response of the speaker. The size of the port is carefully designed with respect to the volume of the cabinet and the characteristics of the woofer to produce low-frequency extension.

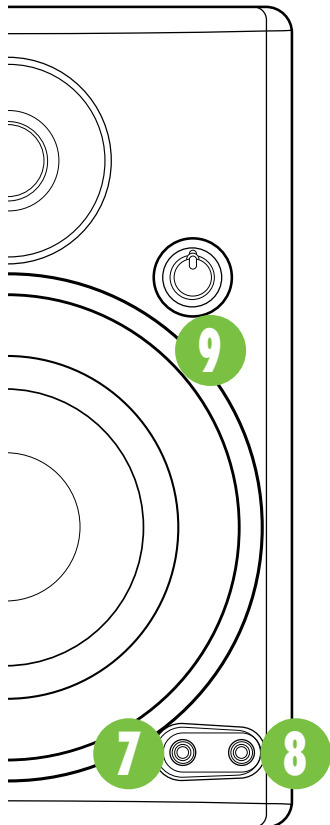

Front Panel Description

7. Aux Input

Connect a line-level signal from an MP3 player, smart phone or other signal source to this input jack using an 1/8" connector.

It is wired as follows, according to standards specified by the AES (Audio Engineering Society):

Stereo 1/8" TRS

Left Channel	Tip
Right Channel	Ring
Ground	Sleeve

8. Phones Output

This 1/8" TRS connector supplies the output to stereo headphones. The volume is controlled with the volume knob [9]. The signal to the power amp is killed when headphones are connected.

The phones output is wired as follows, according to standards specified by the AES (Audio Engineering Society):

Stereo 1/8" TRS

Left Channel	Tip
Right Channel	Ring
Ground	Sleeve



Warning: The headphone amp is loud and could cause permanent hearing damage. Even intermediate levels may be painfully loud with some headphones. BE CAREFUL! Always turn the volume knob all the way down before connecting headphones. Then turn it up slowly as you listen carefully.

9. Volume Knob

CR Series reference monitors expect a line-level signal at its input. Use this control to adjust the sensitivity of the input section according to the signal strength at its input.

The volume knob not only adjusts the overall output level, but it also turns the monitor on and off. Simply turn the knob counter-clockwise until it "clicks" off. Turn the knob clockwise to turn the volume up.

The ring surrounding the volume knob illuminates when the reference monitor is plugged in and the power switch is on.

Refer to the Quick Start section on page 4 for the level-setting procedure.

Input Signal Wiring

Included with the CR Series Reference Monitors are multiple accessories, including:

- 1/8" to stereo RCA cable to connect computer output to speakers
- 1/8" to 1/8" cable to connect a smart phone or media player to front panel of speakers
- Speaker-to-speaker cable

Even though these cables are included, they might need to be replaced at some point [e.g. cats play tug-of-war, kid uses it as a whip, you use it as a makeshift tourniquet, etc.]. Or perhaps you prefer to use the 1/4" inputs. If so, we recommend using high-quality, shielded cables to connect the signal source to the signal input jack [3] on CR Series reference monitors.

Three types of input connectors are provided to interface with virtually any application you may have:

- Balanced TRS / Unbalanced TS cables work well with the 1/4" inputs.
- Unbalanced phono cables work well with the RCA inputs.
- Balanced TRS cables work well with the 1/8" inputs.

NOTE: Route the cable away from AC power cords and outlets. These are common sources for hum in an audio signal. Wall warts and line lumps are especially insidious hum inducers!

NOTE: In certain home theater applications, it may be necessary to connect the speaker outputs from a stereo receiver to the inputs of the CR Series reference monitors if the receiver doesn't have preamp outputs or other line-level output connections.



CAUTION: Do not attempt to connect a speaker output directly to the input of the CR Series reference monitor! Speaker levels are much higher than line levels and can damage the input circuitry in the CR Series reference monitors.

However, it is possible to insert a speaker-level to line-level signal attenuator between the receiver's speaker output and the CR Series reference monitor's input. Any local authorized dealer should be able to assist, or you can build your own.

Care and Cleaning

CR Series reference monitors will provide many years of reliable service if you follow these guidelines.

- Avoid exposing the monitors to moisture.
- Avoid exposure to extreme cold (below freezing temperatures).
- Use a dry cloth to clean the cabinets. Only do this when the power is turned off.

Appendix A: Service Information

If you think your CR Series Reference Monitor has a problem, please check out the following troubleshooting tips and do your best to confirm the problem. Visit the Support section of our website (www.720trees.com) where you will find lots of useful information such as FAQs and other documentation. You may find the answer to the problem without having to send your CRs away.

Troubleshooting

No Power

- Our favorite question: Is it plugged in?
- Make sure the power cord is plugged all the way into the AC outlet.
- Make sure the AC outlet is live (check with a tester or lamp).
- Is the power [2] switch on the rear panel in the ON position?
- Is the ring surrounding the volume knob [9] on the front panel illuminated? If not, make sure the AC outlet is live. If so, refer to “No Sound” below.

No Sound

- Is the ring surrounding the volume knob [9] on the front panel illuminated? If not, refer to “No Power” above.
- Is the volume knob [9] turned up?
- Is the signal source turned up? Make sure the signal level from the computer, mixer, MP3 player, smart phone (or whatever device immediately precedes the reference monitors) is high enough to produce sound.
- If it's a stereo pair, try switching them around. For example, if a left output is presumed dead, switch the left and right cords at the monitor end. If the problem switches sides, it's not the monitor. It could be a bad cable, or no signal from the source.

Bad Sound

- Is the input connector plugged completely into the jack? Make sure it is plugged all the way in.
- Is it loud and distorted? Reduce the signal level at the source.
- If possible, listen to the signal source with headphones plugged into the preamp stage. If it sounds bad there, it's not the monitor.
- Too much bass or not enough bass? Move around the room and see if the bass response changes. It's possible your listening position coincides with a room mode where the low frequencies either become exaggerated or nulled. If so, try moving the monitors to a different position, or moving your listening position.

Noise/Hum/Buzz

- Check the signal cable between the computer/mixer/MP3 player/smart phone and the reference monitor. Make sure all connections are secure. These problems usually produce crackling noises, hum, or buzz.
- If connecting an unbalanced output to the CR Series reference monitor's balanced input, make sure the shield is connected to the unbalanced ground of the source.
- Make sure the signal cable is not routed near AC cables, power transformers, or other EMI sources (including wall warts and line lumps!). These sources usually produce hum.
- Is there a light dimmer or other triac-based device on the same AC circuit as the monitor? Dimmers cause buzzing noises. Use an AC line filter or plug the monitor into a different AC circuit.
- Excessive hiss is an indication of an incorrect gain setting somewhere before the speaker.
- If possible, listen to the signal source with headphones plugged in. If it sounds noisy there, it's not the monitor.

Repair

For warranty service, please refer to the warranty information on page 15.

Non-warranty service is available at a factory-authorized service center. To locate the nearest service center, visit www.720trees.com, click "Contact Tech Support" and select "Locate a Service Center or Distributor" [3]. Service for CR Series Monitors living outside the United States may be obtained through local dealers or distributors.

If you do not have access to our website, please call our Tech Support department at 1-800-898-3211 (normal business hours, Pacific Time), to explain the problem. They will tell you where the nearest factory-authorized service center is located in your area.

Need help with the CR Series Reference Monitor?

- **Visit www.720trees.com and click Support to find: FAQs, manuals, and addendums.**
- **Email us at: techmail@loudtechinc.com.**
- **Telephone 1-800-898-3211 to speak with one of our splendid technical support chaps (Monday through Friday, normal business hours, Pacific Time).**

Appendix B: Technical Information

CR Series Specifications

Acoustic Performance

Frequency Response (-3 dB)	70 Hz – 20 kHz [CR3] 60 Hz – 20 kHz [CR4]
Frequency Response (-10 dB)	80 Hz – 20 kHz [CR3] 70 Hz – 20 kHz [CR4]
Maximum SPL Peak Per Pair	97 dB [CR3] 100 dB [CR4]
Crossover Frequency	3 kHz

Transducers

Low Frequency	3.0 in / 76 mm polypropylene-coated woofer [CR3] 4.0 in / 102 mm polypropylene-coated woofer [CR4]
High Frequency	0.75 in / 19 mm silk dome tweeter

Amplifiers

Rated Power	28 watts rms 50 watts peak
Design	Class AB

Input / Output

Input Type	Balanced / unbalanced 1/4" TRS, unbalanced RCA [Rear] 1/8" TRS [Front]
Input Impedance	20 k Ω , balanced bridging; 10 k Ω unbalanced
Output Type	1/8" stereo headphones [Front]

Power Requirements

United States	120 VAC, 60 Hz
Europe	220 – 240 VAC, 50 Hz
Korea	220 VAC, 60 Hz
Japan	100 VAC, 50/60 Hz
Power Consumption	72 watts with music, loud mix

Note: CR Series monitors do not support multiple voltage configurations. Make sure the voltage rating for your particular model (as indicated on the rear panel) corresponds with your local AC mains voltage.

Construction Features

Basic Design	Rectangular
Enclosure Construction	Solid MDF
Finish	Black vinyl wrap
Handles	At <10 lb each, there is no need for handles!
Port Configuration	Custom-tuned rear port tube
Damping	Adiabatic batting
Display LED (Front)	Power ring (around volume knob)
Operating Temperature	0 – 40 °C 32 – 104 °F

Physical Dimensions and Weight

CR3

Dimensions	
Height	8.2 in / 208 mm
Width	5.5 in / 140 mm
Depth	6.2 in / 158 mm
Weight	9.4 lb / 4.1 kg [pair]

CR4

Dimensions	
Height	8.8 in / 224 mm
Width	6.1 in / 156 mm
Depth	7.3 in / 185 mm
Weight	12.0 lb / 5.4 kg [pair]

Disclaimer

LOUD Technologies is always striving to improve our products by incorporating new and improved materials, components and manufacturing methods. Therefore, we reserve the right to change these specifications at any time without notice.

The Running Man is a registered trademark of LOUD Technologies Inc. This manual also contains names and marks of other companies which belong to those respective companies, and are hereby acknowledged.

©2015 LOUD Technologies Inc. All Rights Reserved.

CR3 Dimensions

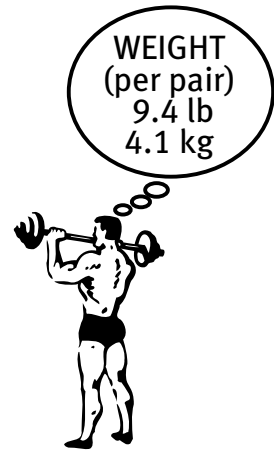
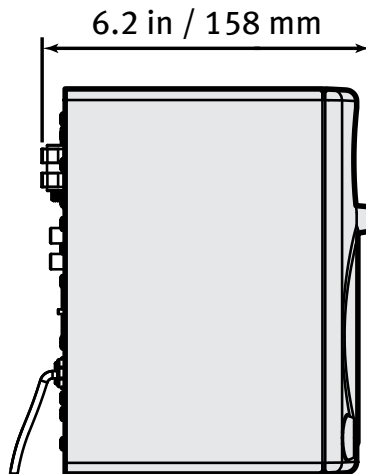
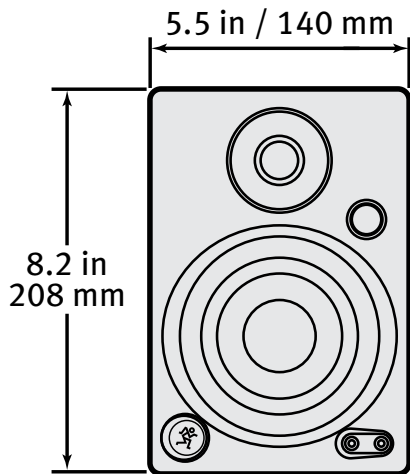

CR4 Dimensions

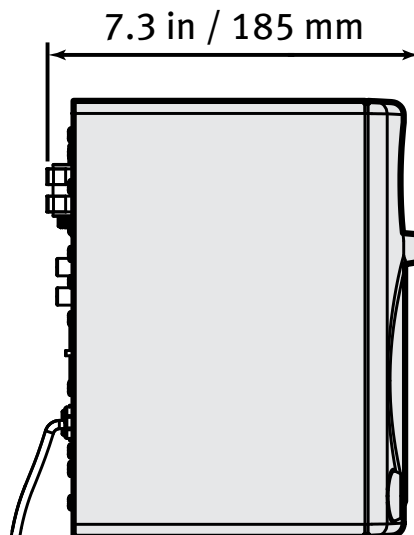
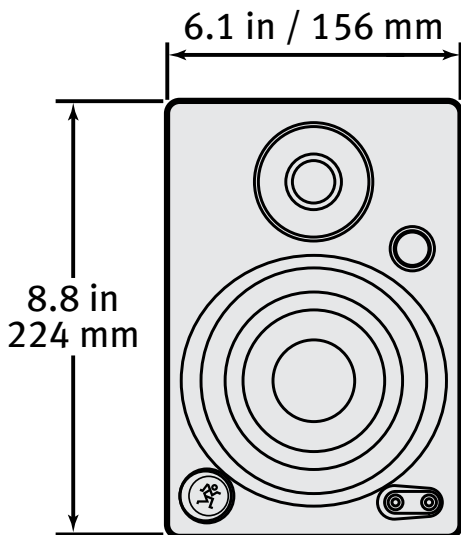

CR Series Block Diagram

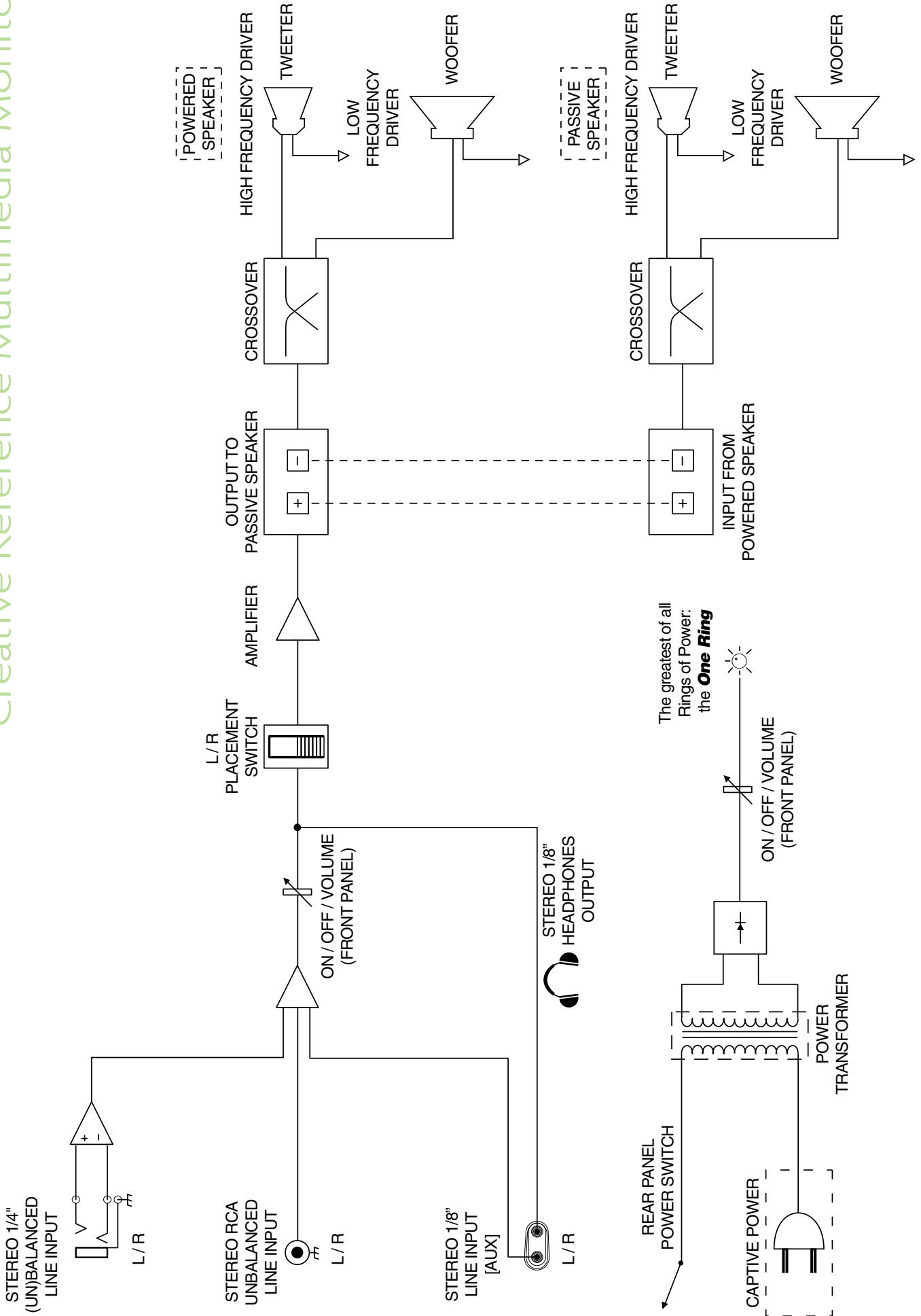

Please keep your sales receipt in a safe place.

This Limited Product Warranty ("Product Warranty") is provided by LOUD Technologies Inc. ("LOUD") and is applicable to products purchased in the United States or Canada through a LOUD-authorized reseller or dealer. The Product Warranty will not extend to anyone other than the original purchaser of the product (hereinafter, "Customer," "you" or "your").

For products purchased outside the U.S. or Canada, please visit www.720trees.com to find contact information for your local distributor, and information on any warranty coverage provided by the distributor in your local market.

LOUD warrants to Customer that the product will be free from defects in materials and workmanship under normal use during the Warranty Period. If the product fails to conform to the warranty then LOUD or its authorized service representative will at its option, either repair or replace any such nonconforming product, provided that Customer gives notice of the noncompliance within the Warranty Period to the Company at: www.720trees.com or by calling LOUD technical support at 1.800.898.3211 (toll-free in the U.S. and Canada) during normal business hours Pacific Time, excluding weekends or LOUD holidays. Please retain the original dated sales receipt as evidence of the date of purchase. You will need it to obtain any warranty service.

For full terms and conditions, as well as the specific duration of the Warranty for this product, please visit www.720trees.com.

The Product Warranty, together with your invoice or receipt, and the terms and conditions located at www.720trees.com constitutes the entire agreement, and supersedes any and all prior agreements between LOUD and Customer related to the subject matter hereof. No amendment, modification or waiver of any of the provisions of this Product Warranty will be valid unless set forth in a written instrument signed by the party to be bound thereby.



16220 Wood-Red Road NE
Woodinville, WA 98072 • USA
Phone: 425.487.4333
Toll-free: 800.898.3211
Fax: 425.487.4337
www.720trees.com

Free Manuals Download Website

<http://myh66.com>

<http://usermanuals.us>

<http://www.somanuals.com>

<http://www.4manuals.cc>

<http://www.manual-lib.com>

<http://www.404manual.com>

<http://www.luxmanual.com>

<http://aubethermostatmanual.com>

Golf course search by state

<http://golfingnear.com>

Email search by domain

<http://emailbydomain.com>

Auto manuals search

<http://auto.somanuals.com>

TV manuals search

<http://tv.somanuals.com>