

ONYX 1220i

12-Channel Premium Analog Mixer
with FireWire

OWNER'S MANUAL

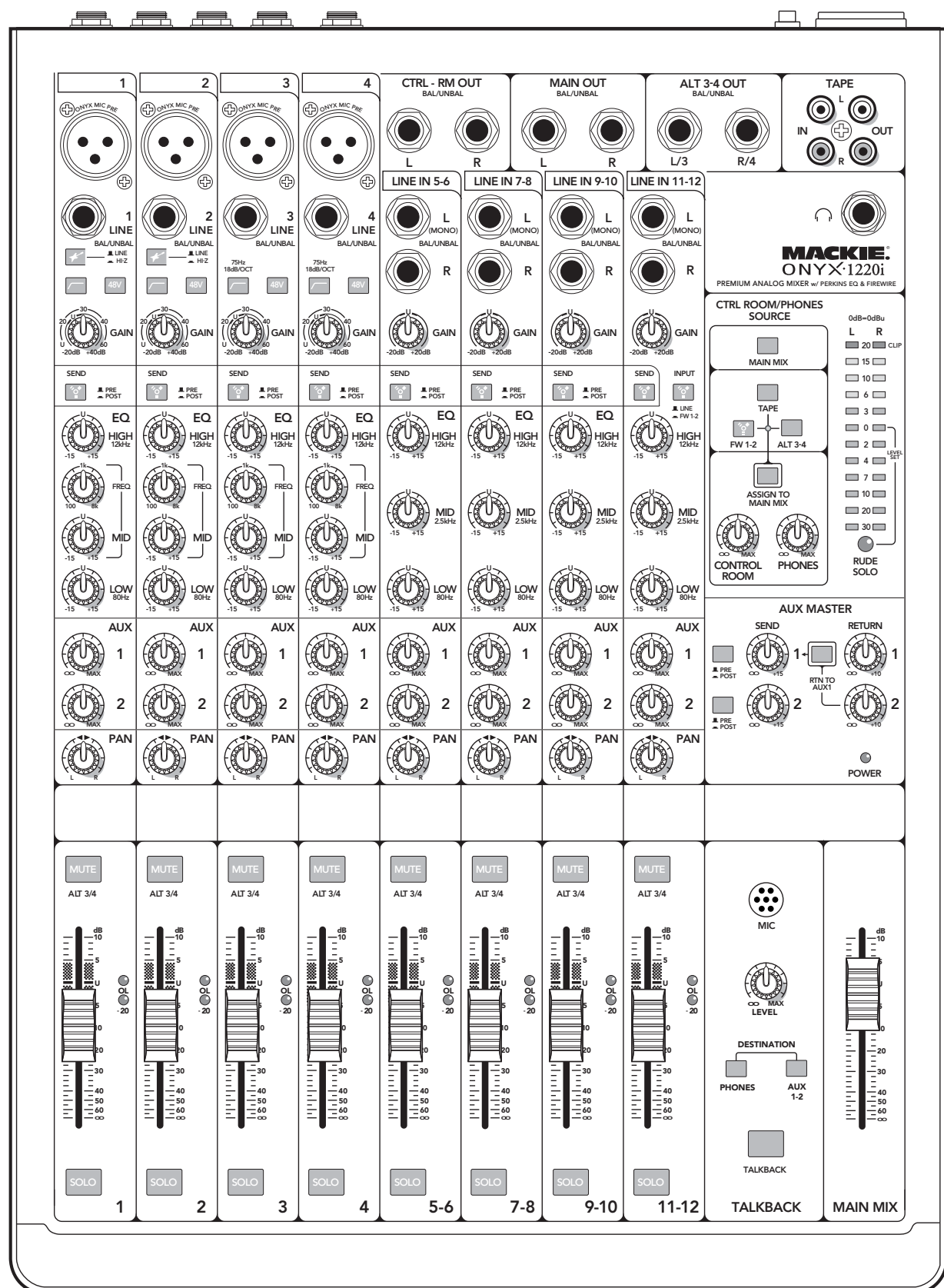

MACKIE®

Important Safety Instructions

1. Read these instructions.
2. Keep these instructions.
3. Heed all warnings.
4. Follow all instructions.
5. Do not use this apparatus near water.
6. Clean only with a dry cloth.
7. Do not block any ventilation openings. Install in accordance with the manufacturer's instructions.
8. Do not install near any heat sources such as radiators, heat registers, stoves, or other apparatus (including amplifiers) that produce heat.
9. Do not defeat the safety purpose of the polarized or grounding-type plug. A polarized plug has two blades with one wider than the other. A grounding-type plug has two blades and a third grounding prong. The wide blade or the third prong are provided for your safety. If the provided plug does not fit into your outlet, consult an electrician for replacement of the obsolete outlet.
10. Protect the power cord from being walked on or pinched particularly at plugs, convenience receptacles, and the point where they exit from the apparatus.
11. Only use attachments/accessories specified by the manufacturer.
12. Use only with a cart, stand, tripod, bracket, or table specified by the manufacturer, or sold with the apparatus. When a cart is used, use caution when moving the cart/apparatus combination to avoid injury from tip-over.
13. Unplug this apparatus during lightning storms or when unused for long periods of time.
14. Refer all servicing to qualified service personnel. Servicing is required when the apparatus has been damaged in any way, such as power-supply cord or plug is damaged, liquid has been spilled or objects have fallen into the apparatus, the apparatus has been exposed to rain or moisture, does not operate normally, or has been dropped.
15. Do not overload wall outlets and extension cords as this can result in a risk of fire or electric shock.
16. This apparatus shall not be exposed to dripping or splashing, and no object filled with liquids, such as vases or beer glasses, shall be placed on the apparatus.
17. This apparatus has been designed with Class-I construction and must be connected to a mains socket outlet with a protective earthing connection (the third grounding prong).
18. This apparatus has been equipped with a rocker-style AC mains power switch. This switch is located on the rear panel and should remain readily accessible to the user.
19. The MAINS plug or an appliance coupler is used as the disconnect device, so the disconnect device shall remain readily operable.



20. NOTE: This equipment has been tested and found to comply with the limits for a Class B digital device, pursuant to part 15 of the FCC Rules. These limits are designed to provide reasonable protection against harmful interference in a residential installation. This equipment generates, uses, and can radiate radio frequency energy and, if not installed and used in accordance with the instructions, may cause harmful interference to radio communications. However, there is no guarantee that interference will not occur in a particular installation. If this equipment does cause harmful interference to radio or television reception, which can be determined by turning the equipment off and on, the user is encouraged to try to correct the interference by one or more of the following measures:

- Reorient or relocate the receiving antenna.
- Increase the separation between the equipment and the receiver.
- Connect the equipment into an outlet on a circuit different from that to which the receiver is connected.
- Consult the dealer or an experienced radio/TV technician for help.

CAUTION: Changes or modifications to this device not expressly approved by LOUD Technologies Inc. could void the user's authority to operate the equipment under FCC rules.

21. This apparatus does not exceed the Class A/Class B (whichever is applicable) limits for radio noise emissions from digital apparatus as set out in the radio interference regulations of the Canadian Department of Communications.

ATTENTION — *Le présent appareil numérique n'émet pas de bruits radioélectriques dépassant les limites applicables aux appareils numériques de class A/de class B (selon le cas) prescrites dans le règlement sur le brouillage radioélectrique édicté par les ministere des communications du Canada.*

22. Exposure to extremely high noise levels may cause permanent hearing loss. Individuals vary considerably in susceptibility to noise-induced hearing loss, but nearly everyone will lose some hearing if exposed to sufficiently intense noise for a period of time. The U.S. Government's Occupational Safety and Health Administration (OSHA) has specified the permissible noise level exposures shown in the following chart. According to OSHA, any exposure in excess of these permissible limits could result in some hearing loss. To ensure against potentially dangerous exposure to high sound pressure levels, it is recommended that all persons exposed to equipment capable of producing high sound pressure levels use hearing protectors while the equipment is in operation. Ear plugs or protectors in the ear canals or over the ears must be worn when operating the equipment in order to prevent permanent hearing loss if exposure is in excess of the limits set forth here:

Duration, per day in hours	Sound Level dBA, Slow Response	Typical Example
8	90	Duo in small club
6	92	
4	95	Subway Train
3	97	
2	100	Very loud classical music
1.5	102	
1	105	Woody and Anita screaming at Troy about deadlines
0.5	110	
0.25 or less	115	Loudest parts at a rock concert

CAUTION AVIS

RISK OF ELECTRIC SHOCK. DO NOT OPEN
RISQUE DE CHOC ELECTRIQUE. NE PAS OUVRIR

CAUTION: TO REDUCE THE RISK OF ELECTRIC SHOCK DO NOT REMOVE COVER (OR BACK) NO USER-SERVICEABLE PARTS INSIDE. REFER SERVICING TO QUALIFIED PERSONNEL
ATTENTION: POUR EVITER LES RISQUES DE CHOC ELECTRIQUE, NE PAS ENLEVER LE COUVERCLE. AUCUN ENTRETIEN DE PIECES INTERIEURES PAR L'USAGER. CONFIER L'ENTRETIEN AU PERSONNEL QUALIFIE.
AVIS: POUR EVITER LES RISQUES D'INCENDIE OU D'ELECTROCUTION, N'EXPOSEZ PAS CET ARTICLE A LA PLUIE OU A L'HUMIDITE

The lightning flash with arrowhead symbol within an equilateral triangle is intended to alert the user to the presence of uninsulated "dangerous voltage" within the product's enclosure, that may be of sufficient magnitude to constitute a risk of electric shock to persons.
Le symbole éclair avec point de flèche à l'intérieur d'un triangle équilatéral est utilisé pour alerter l'utilisateur de la présence à l'intérieur du coffret de "voltage dangereux" non isolé d'ampleur suffisante pour constituer un risque d'électrocution.

The exclamation point within an equilateral triangle is intended to alert the user of the presence of important operating and maintenance (servicing) instructions in the literature accompanying the appliance.
Le point d'exclamation à l'intérieur d'un triangle équilatéral est employé pour alerter les utilisateurs de la présence d'instructions importantes pour le fonctionnement et l'entretien (service) dans le livret d'instruction accompagnant l'appareil.

WARNING — To reduce the risk of fire or electric shock, do not expose this apparatus to rain or moisture.

Quick Start

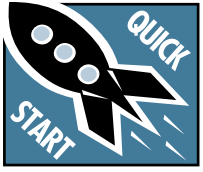

We realize that you must be really keen to try out your new mixer. Please read the safety instructions on page 2, read this page, and then have a look through some of the features and details in this manual.

Setup

Use the mixer in a nice clean and dry environment, free from dryer lint and dust bunnies.

Zero the controls

1. Fully turn down all the knobs and faders to minimum, except for the channel EQ and pan controls, which should be centered.
2. Make sure all buttons are in the out position.

Connections

1. Make sure the AC power switch is off before making any connections.
2. Push the linecord securely into the IEC connector on the rear panel, and plug it into a 3-prong AC outlet. The mixer can accept any AC voltage ranging from 100 VAC to 240 VAC.
3. Plug a balanced microphone into one of the mic XLR (3-pin) connectors. Or connect any line-level signal (keyboard, or guitar preamp) to a line input jack using a TS or TRS 1/4" plug.
4. If your microphone requires phantom power, press in the 48V phantom power button.
5. You can connect a guitar directly to line inputs 1 or 2 without the need for a DI box. Press a hi-z switch if you connect a guitar directly.
6. The insert jacks of channels 1 to 4 can be used to connect an external effects or dynamics processor into the channel signal chain.
7. Connect the main outputs of the mixer (either XLR or TRS 1/4") to the line-level inputs of your amplifier (with speakers already attached) or to the line-level inputs of powered speakers.
8. Engage the main mix switch in the control room/phones source selection, so the meters will show the main mix levels in the next steps.

Set the levels

It's not even necessary to hear what you're doing to set optimal levels. But if you'd like to: Plug in headphones and turn up the phones knob just a little.

1. Turn on the mixer's power switch.
2. For one channel, press the solo switch in, and the rude solo light will turn on.
3. Play something into that input at real-world levels.
4. Adjust that channel's gain control until the right main meter stays around the 0 dB LED (marked "level set").
5. Disengage the channel's solo switch.
6. Repeat steps 2 to 5 for the remaining channels.
7. Turn up a channel fader to the "U" mark.
8. Slowly turn up the main mix fader until you hear the signals in your speakers or headphones.
9. If needed, apply some channel EQ wisely.
10. Adjust the channel faders to get the best mix. Keep the gain controls and faders fully down on unused channels.
11. During the performance, if you notice a channel OL LED turning on during peaks, carefully turn down that channel's gain control until OL does not turn on.

FireWire

- See page 34 for details of getting started with FireWire.
- PC drivers are on the supplied CD-ROM. Mac OS X contains built-in drivers, so no software installation is required.

Other Notes

- When shutting down, turn off any power amplifiers or powered speakers first. When powering up, turn them on last. This will reduce the chance of turn-on or turn-off thumps.
- Always turn down the phones level when making connections, pressing solo, or doing anything that may cause loudness in the headphones. This will help protect your hearing.
- Always turn down the main mix level and control room level when making connections to the mixer. Better yet, turn off the power.
- Save the shipping box!

Part No. SW0722 Rev. B 02/2010

©2010 LOUD Technologies Inc. All Rights Reserved.

Loosely based on a dream sequence in which the technical writer is given keys to a sports car of his choice, unlimited gas, and closed roads. The dream suddenly ends and reality kicks in. A mixer manual to write, a mixer manual to write!

Introduction

Thank you for choosing a Mackie Onyx 1220i professional compact mixer. The Onyx-i series of mixers offer built-in FireWire, along with the newest features and latest technologies for live sound reinforcement and analog or digital studio recording, all in a durable, road-worthy package.

The Onyx 1220i is equipped with four of our premium precision-engineered studio-grade Onyx mic preamps. Mackie is renowned for the high-quality mic preamps used in our mixers, and the Onyx mic pre's are better than ever, with specifications rivaling expensive stand-alone mic preamplifiers.

Channels 1 and 2 feature high-impedance instrument/line-level inputs so you can connect an acoustic, electric, or bass guitar directly into the mixer, eliminating the need for an external direct box.

Extremely adaptable DAW integration

Recording and Mixing

Channels, aux sends or the master L/R can be sent straight to your computer via FireWire for recording. Pre/post EQ taps on every channel allow you to integrate our renowned Perkins EQ into the record path. Plus, a stereo return from your DAW, or iTunes® is assignable to the control room section or straight back into channels 11-12 for mix integration.

Powerful Effects Engine

With both aux sends routable to your DAW, the 1220i allows you to use your favorite plug-in as a realtime effect. Just route an aux send to your DAW, apply the plug-in and assign your DAW outputs to the control room or to channels 11-12 for instant integration into the mix.

Live Recording

Live sound recording could not be simpler with the 1220i. The ability to record individual channels either wet or dry allows for studio quality multi-track recordings for later editing and mixdown. Or simply record the main mix, allowing for immediate creation of CDs right at the gig.

Features

- Premium 12-channel super-compact analog mixer with integrated Fire wire I/O
- 4 mono channels (mono mic and mono line inputs)
- 4 stereo channels (stereo line inputs)
- 4 Onyx mic preamps with sound comparable to boutique preamps
- 3-band Perkins EQ with sweepable mids on mono channels
- 3-band Perkins EQ on stereo line channels
- Flexible FireWire routing with up to 12 channels pre/post EQ, aux sends and master L/R routable to computer
- 2 channels of FireWire monitoring routable to either the control room or channels 11 and 12
- 2 independent aux sends with separate pre/post switches
- Selectable instrument inputs on first two channels – no DI box is needed
- Individual 48v phantom power switches on all mic inputs
- Talkback section with built in mic and flexible routing
- "Planet-Earth" switching power supply for worldwide use
- Optional rack kit available

How To Use This Manual

The first pages after the table of contents are the hookup diagrams. These show typical setups for fun times with your mixer.

Next is a detailed tour of the entire mixer. The descriptions are divided into sections, just as your mixer is organized into distinct zones:

- Back panel
- Connection section
- Channel controls
- Master controls

Throughout these sections you'll find illustrations with each feature numbered and described in nearby paragraphs.



This icon marks information that is critically important or unique to the mixer. For your own good, read them and remember them.



This icon will lead you to some explanations of features and practical tips. Go ahead and skip these if you need to leave the room in a hurry.

Appendix A: Service information.

Appendix B: Connectors.

Appendix C: Technical information.

Appendix D: Rack ear installation.

Appendix E: FireWire.

Appendix F: Modifications.

Need help with your new mixer?

- **Visit www.mackie.com and click Support to find: FAQs, manuals, addendums, and other useful information.**
- **Email us at: techmail@mackie.com.**
- **Telephone 1-800-898-3211 to speak with one of our splendid technical support chaps (Monday through Friday, normal business hours, PST).**

Contents

IMPORTANT SAFETY INSTRUCTIONS	2	CONTROL ROOM/PHONES AND METERS	22
QUICK START	3	35. MAIN MIX	22
INTRODUCTION	4	36. TAPE, FW 1-2, ALT 3-4	22
HOOKUP DIAGRAMS.....	7	37. ASSIGN TO MAIN MIX	22
FEATURES.....	11	38. CONTROL ROOM KNOB	22
REAR PANEL.....	11	39. PHONES KNOB	23
1. POWER CONNECTION.....	11	40. LEFT/RIGHT LEVEL METERS.....	23
2. POWER SWITCH.....	11	41. RUDE SOLO LIGHT	23
3. FIREWIRE CONNECTIONS.....	11	AUX MASTER.....	24
4. LEFT/RIGHT XLR MAIN OUTPUTS	12	42. MASTER AUX SEND 1 AND 2.....	24
5. MAIN OUTPUT LEVEL.....	12	43. PRE/POST	24
6. AUX SEND 1 AND 2.....	12	44. MASTER AUX RETURN 1 AND 2	24
7. AUX RETURN 1 AND 2	12	45. RTN TO AUX 1	24
8. INSERT (CH. 1-4)	12	46. POWER LED.....	25
CONNECTION SECTION	13	TALKBACK	25
9. MIC INPUTS	13	47. TALKBACK MIC	25
10. MONO LINE INPUTS (CH. 1-4)	13	48. TALKBACK LEVEL	25
11. STEREO LINE INPUTS (CH. 5-12)	14	49. DESTINATION: PHONES, AUX 1-2.....	25
12. CTRL-RM OUT	14	50. TALKBACK SWITCH	26
13. LEFT/RIGHT 1/4" MAIN OUTPUTS	14	MAIN MIX.....	26
14. ALT 3-4 OUT	14	51. MAIN MIX	26
15. TAPE INPUTS	15	MAIN MIX AND FIREWIRE.....	26
16. TAPE OUTPUTS	15	APPENDIX A: SERVICE INFORMATION	27
17. HEADPHONE OUTPUT	15	APPENDIX B: CONNECTIONS.....	28
CHANNEL CONTROLS	16	APPENDIX C: TECHNICAL INFORMATION	30
18. HI-Z SWITCH (CH. 1 AND 2 ONLY)	17	APPENDIX D: RACK EAR INSTALLATION	33
19. LOW CUT (CH.1-4 ONLY)	17	APPENDIX E: FIREWIRE	34
20. 48V PHANTOM POWER (CH.1-4 ONLY)..	18	APPENDIX F: MODIFICATIONS	38
21. GAIN CONTROL.....	18	LIMITED WARRANTY.....	40
22. SEND FIREWIRE PRE/POST.....	18		
23. INPUT (LINE OR FW 1-2).....	18		
24. HIGH EQ.....	19		
25. MID EQ FREQUENCY (CH. 1-4)	19		
26. MID EQ LEVEL (CH. 1-4)	19		
27. MID EQ LEVEL (CH. 5-12)	19		
28. LOW EQ.....	19		
29. AUX SEND 1 AND 2.....	20		
30. PAN.....	20		
31. MUTE SWITCH AND ALT 3-4.....	20		
32. -20 AND OL LEDS	21		
33. CHANNEL FADER	21		
34. SOLO.....	21		

Hookup Diagrams

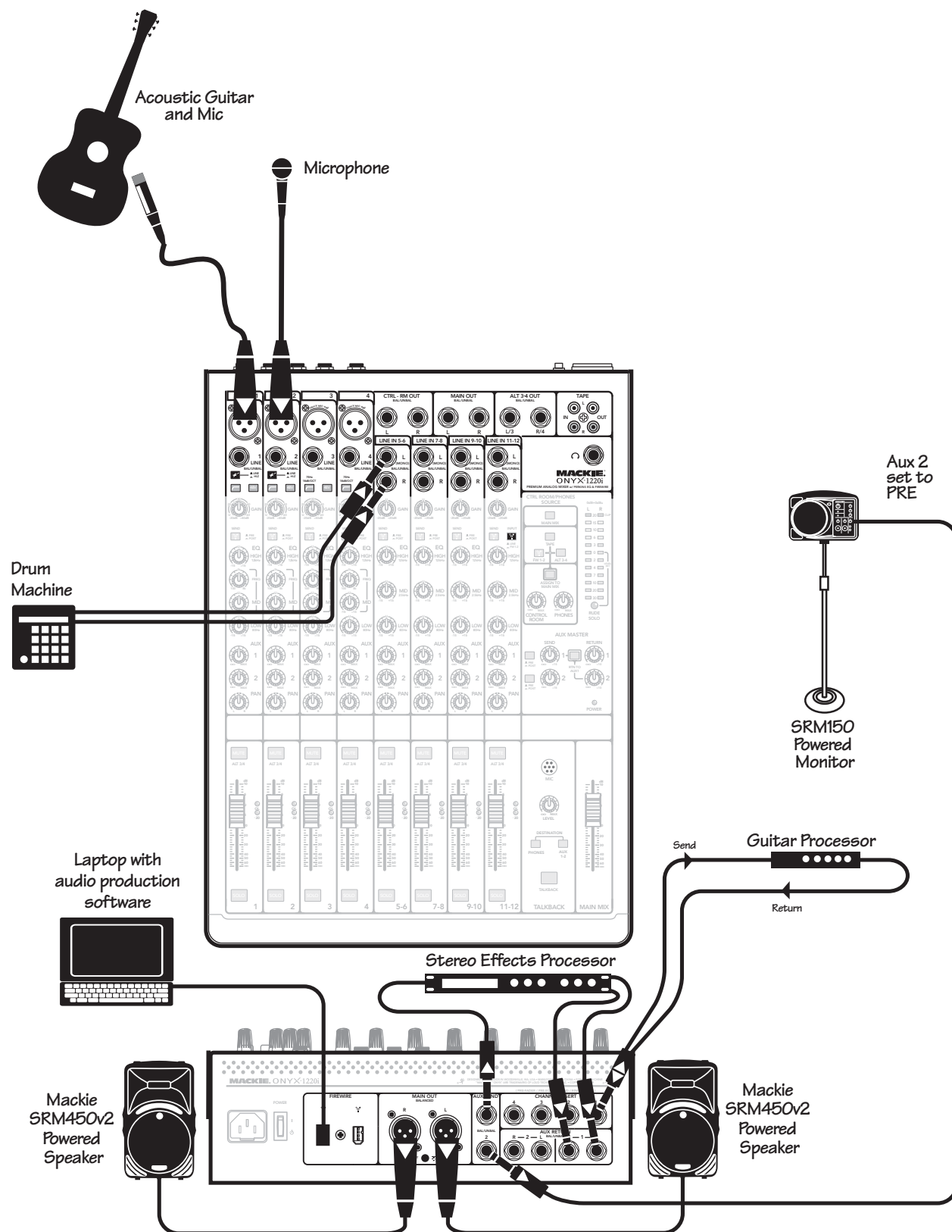

This diagram shows an acoustic guitar mic'd up directly to channel 1 and a microphone connected to channel 2 for vocals. A guitar processor is connected to the insert jack of channel 1.

An effects processor receives a mono input from the aux 1 send, and its stereo outputs connect to the stereo return inputs. Aux 1 is set **post-fader**, using the Aux 1 pre/post switch in the Aux Master section.

A Mackie SRM150 powered speaker is connected to aux send 2 as a monitor for the performer(s). Aux 2 is set to **pre-fader**, using the Aux 2 pre/post switch in the Aux Master section.

Mackie SRM450v2 powered speakers are connected to the left and right main outputs.

A laptop connects to the FireWire port, and allows the 2-channel main mix of the performance to be recorded using your audio production software. Two channels of audio can also play from the computer to the main mix. For example, you can play intermission music when the call for an egg-nog decaf latté or green tea gets too strong and you have to take a break.

1-2 Man Coffeehouse Gig

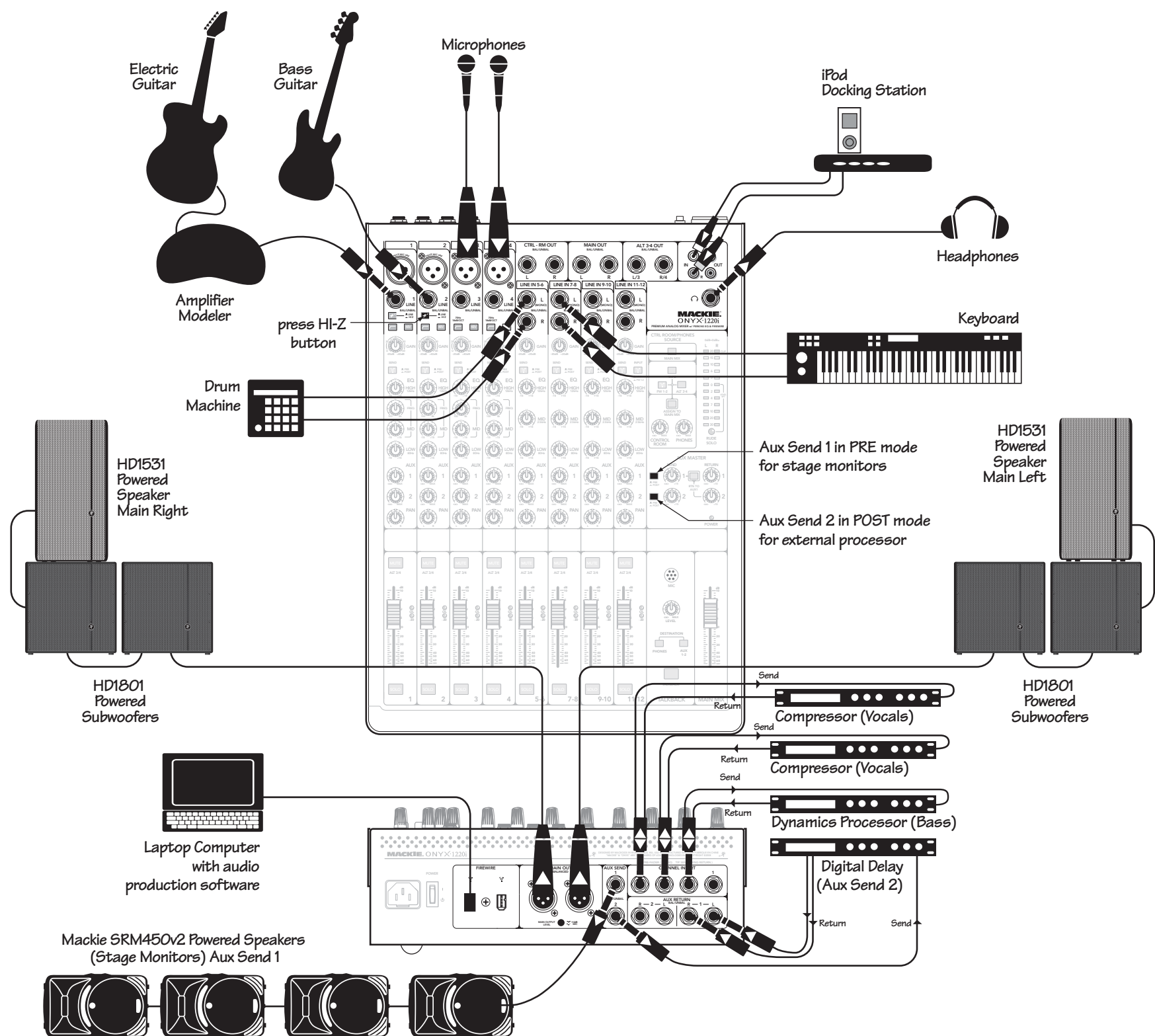

This diagram shows an electric guitar connected to the channel 1 line input via an amplifier modeller, a bass guitar connected directly to channel 2 (hi-z switch in), microphones connected to the channel 3 and 4 mic inputs, a drum machine connected to the channel 5-6 stereo line inputs, and a keyboard connected to the channel 7-8 stereo line inputs. An iPod dock connects to the tape input.

A dynamics processor is connected to the insert jack of channel 2 to work its magic on your bass. Vocal compressors are connected to the channel 3 and 4 inserts.

A delay processor receives a mono input from aux 2 send (in post-fader mode), and its stereo outputs connect to the stereo aux 1 return inputs.

A plethora of SRM450v2 powered speakers are strewn across the stage as monitors for the band; they are connected to the aux 1 send jack (in pre-fader mode). Headphones are used to monitor levels.

The club is driven by connecting quad HD1801 powered subwoofers and a pair of HD1531 powered speakers to the main left and right outputs.

A laptop computer connects to a FireWire port, allowing the 2-channel main mix, individual channels, and the aux sends to be recorded. Two channels can be played back from your audio production software. These can enter as either a source for the control room and phones, or channels 11 and 12.

Typical Club System

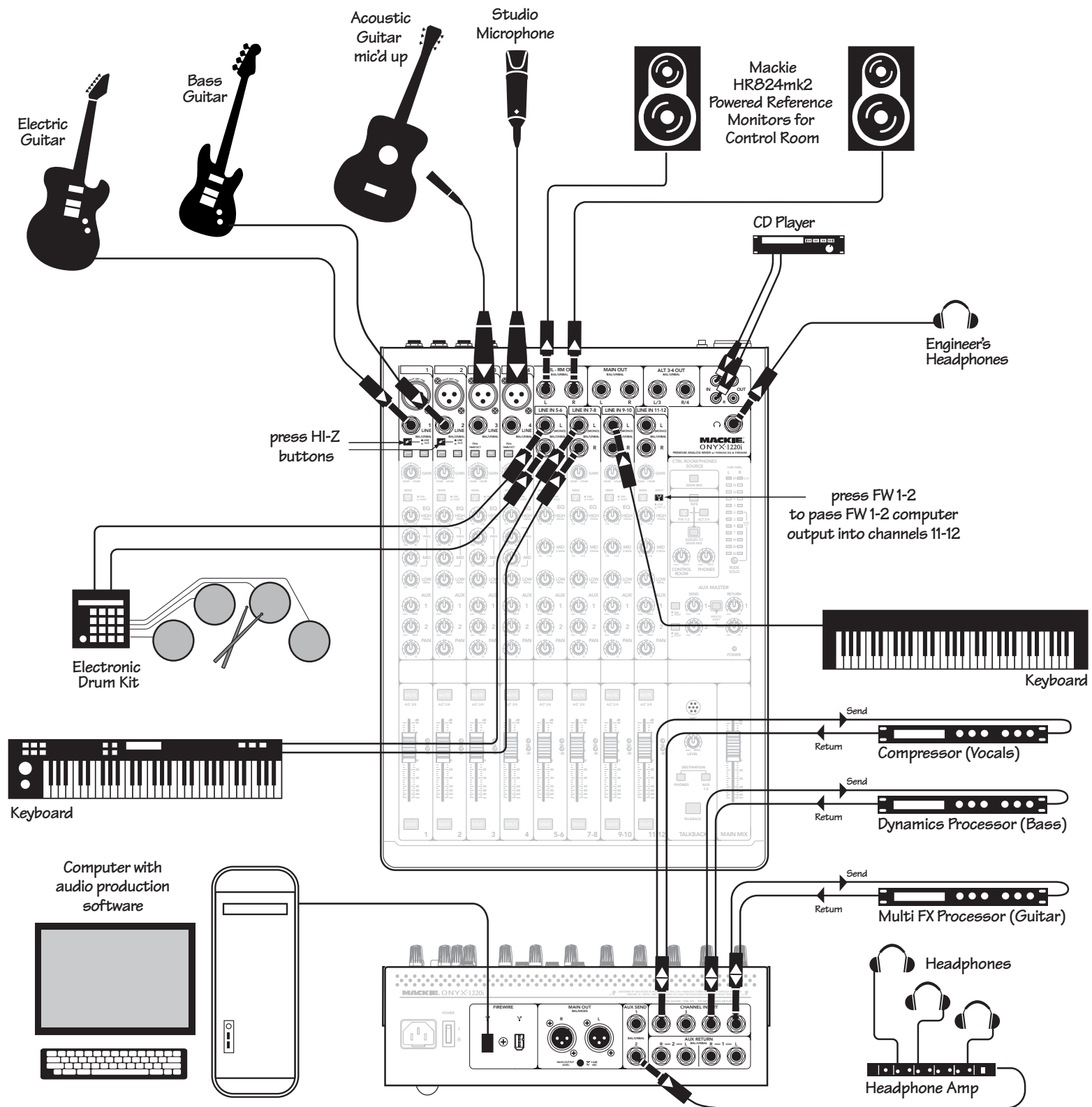

This diagram shows an electric guitar connected directly to the channel 1 input (hi-z switch in), a bass guitar connected directly to channel 2 (hi-z switch in), an acoustic guitar mic'd up and connected to the channel 3 mic input, a studio mic connected to the channel 4 mic input, an electronic drum set connected to the channel 5-6 stereo line inputs, a keyboard connected to the channel 7-8 stereo line inputs, and a keyboard mono output connected to channel 9 (left input). A CD player connects to the tape input.

A multi-FX processor is connected to the insert jack of channel 1 to work its magic on your guitar. A dynamics processor is connected to the insert jack of channel 2 for your bass. A compressor is connected to the insert jack of channel 4 for your vocals.

Mackie HR824mk2 powered reference monitors are used for your control room listening. The engineer's headphones are used to monitor levels. Aux 2 is set up to provide the feed to a headphone amplifier and your band's headphones.

A desktop computer connects to a FireWire port, allowing the 2-channel main mix, individual channels, and the aux sends to be recorded, and two channels to be played back using audio production software.

Mixer channels 11-12 can play the 2-channel signals from your computer if the FW 1-2 switch at the top of the 11-12 channel strip is engaged. Aux 1 and 2 can be sent via FireWire to a software effects plug-in. (In the case above, aux 2 is used for the headphone amp.)

Typical Recording System

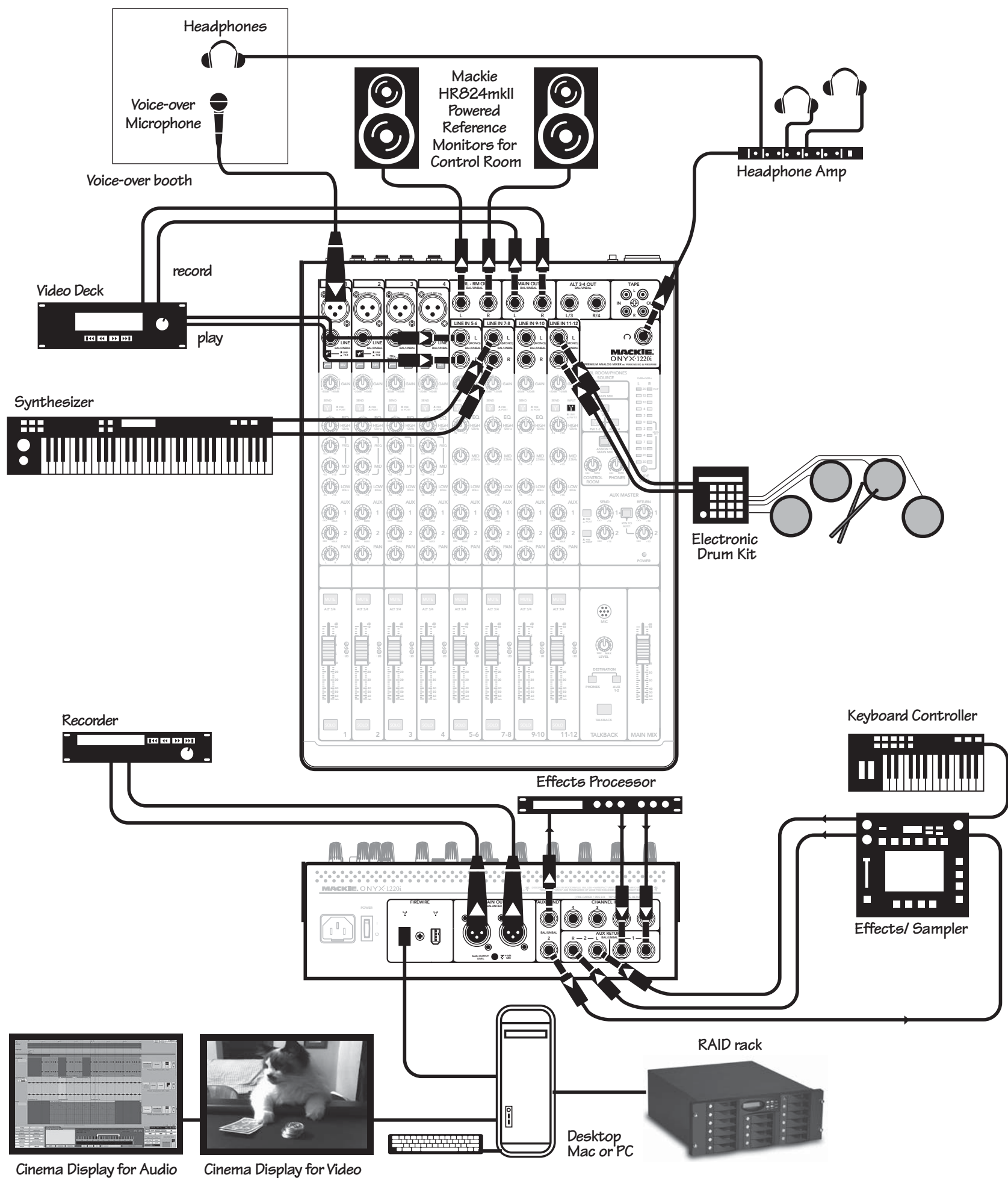

This diagram shows a voice-over microphone connected to the channel 1 mic input, a video deck's audio outputs connected to channels 5/6, with its audio inputs receiving the main mix from the 1/4" main outputs. A synthesizer is connected to channel 7/8, and an electronic drum kit is connected to channel 11/12.

An effects processor and a sampler each receive a mono input from an aux send (**post-fader**), and their stereo outputs connect to the respective stereo return inputs. A keyboard controller is attached to the sampler. Headphones are used to monitor all levels, using a headphone amp with multiple headphones, including one in the voice-over booth.

A pair of Mackie HR824mkII powered reference monitors are connected to the left and right control room outputs for careful and accurate monitoring in the control room.

A desktop Mac or PC is connected to a FireWire port, allowing the 2-channel main mix to be recorded and two channels to be played back. Two cinema screens are connected to the desktop, one displaying audio and the second for video. A RAID rack is attached to the computer for mass storage. A recorder is connected to the XLR main outs, and utilized as the master recorder.

Post-Production System

Onyx 1220i Features

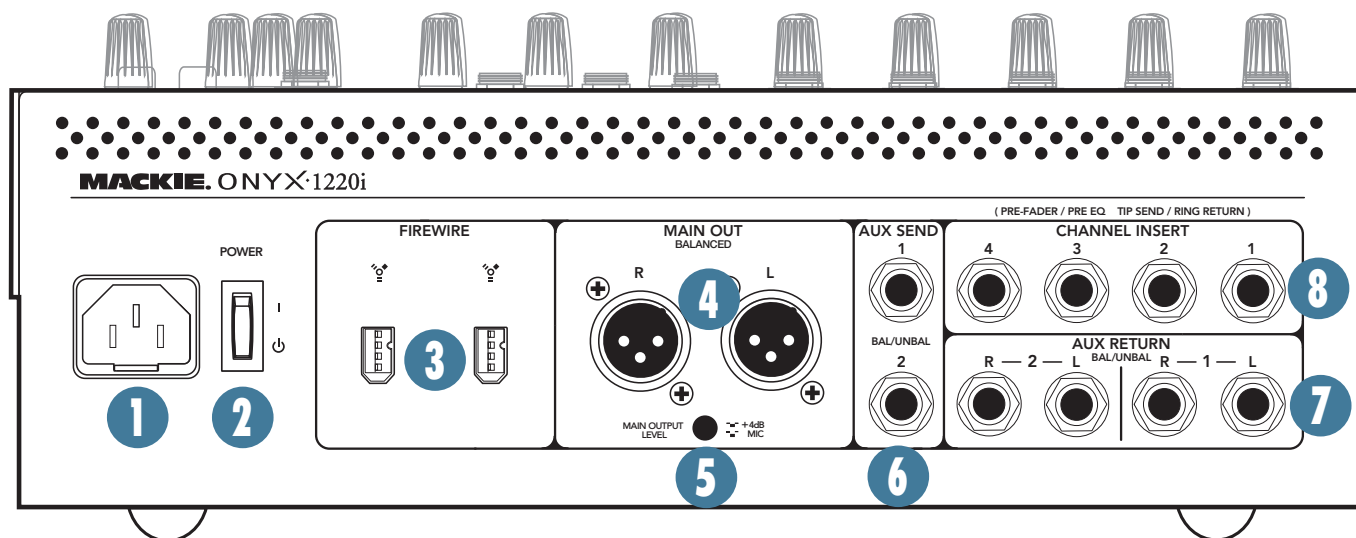

Rear Panel

1. POWER CONNECTION

This is a standard 3-prong IEC power connector. Connect the detachable linecord (included in the box with your mixer) to the power receptacle, and plug the other end of the linecord into an AC outlet. The Onyx 1220i has a universal power supply that can accept any AC voltage ranging from 100 VAC to 240 VAC. No need for voltage select switches. It will work virtually anywhere in the world. That's why we call it a "Planet-Earth" power supply! It is less susceptible to voltage sags or spikes, compared to conventional power supplies, and provides greater electromagnetic isolation and better protection against AC line noise.



VERY IMPORTANT Disconnecting the plug's ground pin is dangerous. Don't do it.

2. POWER SWITCH

Press the top of this rocker switch inwards to turn on the mixer. The front panel power LED [46] will glow with happiness, or at least it will if you have the mixer plugged into a suitable live AC mains supply.

Press the bottom of this switch to put the mixer into standby mode. It will not function, but the circuits are still live. To remove AC power, either turn off the AC mains supply, or unplug the power cord from the mixer and the AC mains supply.



A CLOSER LOOK As a general guide, you should turn on your mixer first, before any external power amplifiers or powered speakers, and turn it off last. This will reduce the possibilities of any turn-on, or turn-off thumps in your speakers.

3. FIREWIRE CONNECTIONS

FireWire is a high-speed two-way interface for connecting digital devices. Two FireWire connectors allow the transfer of digital audio to and from your computer or digital audio workstation (DAW) with ultra-low latency. Usually, only one connector is used.

The FireWire interface provides the following outputs to your computer:

- Channels 1–12, tapped pre-fader, and either pre-EQ, or post EQ (your choice).
- Aux send 1 and 2 (a copy of the final aux outputs to your stage monitors or processors).
- Left/right main mix. The left/right main mix at the FireWire output is not affected by the main mix level control (important for recording live).

Use FireWire to record a live performance directly to your computer, then you can mixdown to a stereo mix later. Or you can use FireWire to turn your Onyx mixer into a high-quality computer audio interface for your DAW.

FireWire also provides a return for two channels from a DAW or laptop. This can be routed through the control room/phones via the FireWire button [36], to monitor the computer audio through your control room speakers or headphones (or through the main speakers if assign to main mix [37] is selected). In this way, you can listen to pre-recorded songs and iTunes® as intermission music, or examples of how the practice sessions should really sound.

These same two channels from the computer can also be chosen as inputs to channels 11 and 12, allowing you to adjust the gain, EQ, level, and pan,

as well as to solo, and add to aux send 1 and 2. This is routed using the FW/line input selector [23] on channels 11 and 12. This is useful for live performances, where those 2 channels might have, for example, a software synthesizer you are triggering from a MIDI keyboard, and you want to treat the softsynth as "just another instrument," with equal processing and routing options as the hardware keyboards coming into the other channels.

The FireWire interface works with both PC (using ASIO for Windows XP and Vista) and Mac (Core Audio for Mac OS 10.4.11 or higher).

4. LEFT/RIGHT XLR MAIN OUTPUTS

These male XLR connectors provide a balanced line-level signal that represents the end of the mixer chain, where your fully mixed stereo signal enters the real world. Connect these to the inputs of your main power amplifiers, powered speakers, or serial effects processor (like a graphic equalizer or compressor/limiter). It provides a fully balanced signal that is the same level as the 1/4" TRS main out jacks [13] on the top panel.

5. MAIN OUTPUT LEVEL

When this switch is out (+4 dB), the XLR main outputs [4] provide a "+4 dBu" line-level signal. You can then connect these outputs to the line-level inputs of power amplifiers, powered loudspeakers, or serial processors.

When the switch is pushed in (mic), the XLR main outputs are attenuated to microphone level. You can then connect these outputs safely to the microphone inputs of another mixer, providing a submix for keyboards or drums, for example, in a live sound application. The main outputs can then be plugged directly into a stage snake, and appear back at the front of house console like any other microphone level source.



When mic is engaged, you can safely plug the XLR main output into a mixer's microphone input, even if it provides 48 V phantom power.

The switch is recessed, to reduce the chance of accidentally turning it on or off when plugging things in.

6. AUX SEND 1 and 2

These 1/4" TRS connectors allow you to send balanced or unbalanced line-level outputs to external effects devices, headphone amplifiers, or stage monitors. These could either be passive stage monitors powered by an external amplifier, or powered stage monitors with built-in power amplifiers.

Aux send 1 and aux send 2 are independent of each other, so you can set up two separate aux mixes.

The aux 1 send signal is the sum (mix) of all the channels whose aux 1 send control [29] is set to more than minimum. The aux 2 send is the sum of all the channels whose aux 2 send control is set to more than minimum. The overall aux output level can be adjusted with the aux send master controls [42].

The aux sends can either be pre or post fader, depending on the position of the pre/post switches [43]. For stage monitor work, use pre, so the stage monitors do not increase in volume when the channel faders are adjusted. Imagine how upsetting that can be to big hairy drummers. This allows you to set up the monitor mix and levels just right, and not have it change every time a channel fader is adjusted.

For external processors, use post. In this way, the feed to external processors will vary with the channel faders, so the level of any returned effect (like an echo) will also change if the channel fader is changed, keeping them in the same ratio (wet/dry).

7. AUX RETURN 1 and 2

These 1/4" TRS stereo input connectors allow you to add the stereo processed output from external effects processors or other devices to the main mix.

Level adjustment of the incoming signals is made with the aux return controls [44].

The signals going into aux return 2 can also be added to aux send 1 by engaging the return to aux 1 switch [45]. For example, you could add effects from an external effects processor to your stage monitors.

You can also use these inputs to add any stereo line-level signals to your main mix, so it could be another line-level source, not just an effects processor.

If you are connecting a mono source, use the left (mono) aux return input, and the mono signals will appear on both sides of the main mix.

8. INSERT (Ch. 1-4)

These unbalanced 1/4" jacks on channels 1-4, are for connecting serial effects processors such as compressors, equalizers, de-essers, or filters. The insert point is after the gain control [21] and low cut filter [19], but before the channel's EQ and fader [33]. The channel signal can go out of the insert jack to an external device, be processed and come back in on the same insert jack. To do this requires a standard insert cable that must be wired thusly:

Tip = send (output to effects device)

Ring = return (input from effects device)

Sleeve = common ground

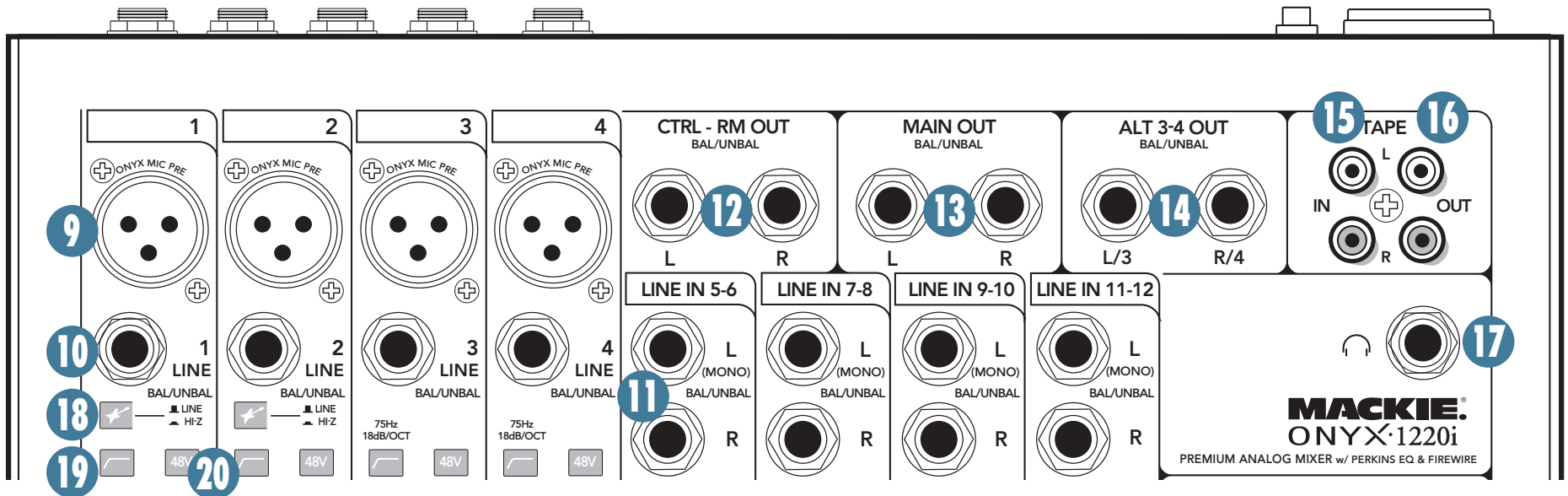

Insert jacks continued...

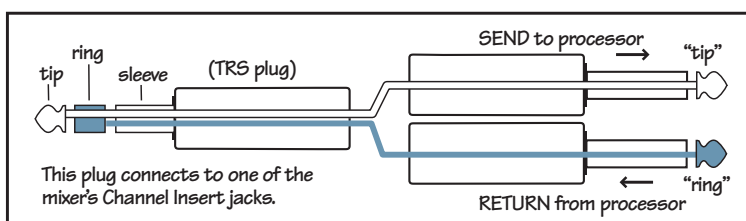

Insert jacks can be used as channel direct outputs; post-gain, and pre-EQ. See the connector section on page 29 (figure G) showing three ways to use inserts.

Connection Section

This is where you plug in things such as: microphones, line-level instruments, guitars, effects, a recorder, PA system, powered monitors, powered subwoofer, etc. Check out the hookup diagrams for some connection ideas. See Appendix B (page 28) for further details and some rather lovely drawings of the connectors you can use with your mixer.

9. MIC INPUTS

This is a female XLR connector, that accepts a balanced microphone input from almost any type of microphone. The microphone preamps feature our Onyx design, with higher fidelity and headroom rivaling any standalone mic preamp on the market today.

The XLR inputs are wired as follows:

- Pin 1 = Shield or ground
- Pin 2 = Positive (+ or hot)
- Pin 3 = Negative (– or cold)

We use phantom-powered, balanced microphone inputs just like the big studio mega-consoles, for exactly the same reason: This kind of circuit is excellent at rejecting hum and noise. You can plug in almost any kind of mic that has a standard XLR-type male mic connector.

Professional ribbon, dynamic, and condenser mics all sound excellent through these inputs. The mic inputs will handle any kind of mic level you can toss at them, without overloading.

Microphone-level signals are passed through the mixer's splendid microphone preamplifiers to become line-level signals.

PHANTOM POWER

Most modern professional condenser mics require 48V phantom power, which lets the mixer send low-current DC voltage to the mic's electronics through the same wires that carry audio. (Semi-pro condenser mics often have batteries to accomplish the same thing.) "Phantom" owes its name to an ability to be "unseen" by dynamic mics (Shure SM57/SM58, for instance), which don't need external power and aren't affected by it anyway.

Phantom power for each channel can be selected using that channel's phantom [20] switch.



Never plug single-ended (unbalanced) microphones, or ribbon mics into the mic input jacks if phantom power is on. Do not plug instrument outputs into the mic XLR input jacks with phantom power on, unless you are certain it is safe.

10. MONO LINE INPUTS (Ch. 1-4)

These 1/4" jacks share circuitry (but not phantom power) with the mic preamps, and can be driven by balanced or unbalanced sources.

To connect balanced lines to these inputs, use a 1/4" Tip-Ring-Sleeve (TRS) plug, wired as follows:

- Tip = Positive (+ or hot)
- Ring = Negative (– or cold)
- Sleeve = Shield or ground

To connect unbalanced lines to these inputs, use a 1/4" mono (TS) phone plug, wired as follows:

Tip = Positive (+ or hot)
Sleeve = Shield or ground

The line-level inputs of channels 1 and 2 can also accept instrument-level signals if the hi-z switches [18] are pressed in. This allows you to connect guitars directly to channels 1 and 2, without the need for a DI box. The input impedance is optimized for direct connection, and high-frequency fidelity is assured.

11. STEREO LINE INPUTS (Ch. 5-12)

These 1/4" jacks can be driven by balanced or unbalanced sources.

To connect balanced lines to these inputs, use a 1/4" Tip-Ring-Sleeve (TRS) plug, wired as follows:

Tip = Positive (+ or hot)
Ring = Negative (- or cold)
Sleeve = Shield or ground

To connect unbalanced lines to these inputs, use a 1/4" mono (TS) phone plug, wired as follows:

Tip = Positive (+ or hot)
Sleeve = Shield or ground

If you just have a mono source, plug it into the left input (labeled left/mono), and the signal will appear (as if by magic) equally on the left and right of the main mix.

12. CTRL-RM OUT

These 1/4" TRS jacks provide balanced left and right-line-level outputs to run studio monitors in the control room. Connect these outputs to the inputs of an amplifier, powered speakers, or recording device.

The source that plays in the control room, headphones, and meters can be selected using the switches [35, 36] in the control room/phones source matrix:

- The main mix, if main mix is selected as the control room/phones source
- Tape outputs, if tape is selected
- Alt 3-4 outputs if alt 3-4 is selected
- A 2-track FireWire feed from your computer if FW 1-2 is selected
- A combination of all four above

Except for main mix, whatever is playing in these outputs can also be routed to the main mix if assign to main mix [37] is engaged. (The main mix input to the control room is disconnected if assign to main mix is engaged.)

The headphones and meters play the same program as the control room. The meters show the levels prior to the control room and phones level controls.

13. LEFT/RIGHT 1/4" MAIN OUTPUTS

These 1/4" TRS output connectors provide the balanced or unbalanced line-level output of the main mix to an anxiously-waiting world. This is the same signal that appears at the XLR main outputs [4] on the rear panel, except it is not affected by the main output level switch [5].

Connect these outputs to the next device in the signal chain, such as an external processor (graphic equalizer or compressor/limiter), external power amplifiers running passive loudspeakers, or to the inputs of powered loudspeakers. They could also be connected to the inputs of a balanced 2-track recorder, when doing a "live to 2-track" type recording.

14. ALT 3-4 OUT

These 1/4" TRS jacks provide a balanced line-level signal that can provide an alternate stereo mix for recording or subgrouping. Connect these outputs to the inputs of an amplifier, powered speaker, or recording device.

Any channel whose mute switch [31] is engaged, is added to the alt 3-4 outputs.

The alt 3-4 output doesn't have a master level control. All channels assigned to the alt 3-4 bus are summed together (post-fader and pan) and sent directly to the alt 3-4 out.

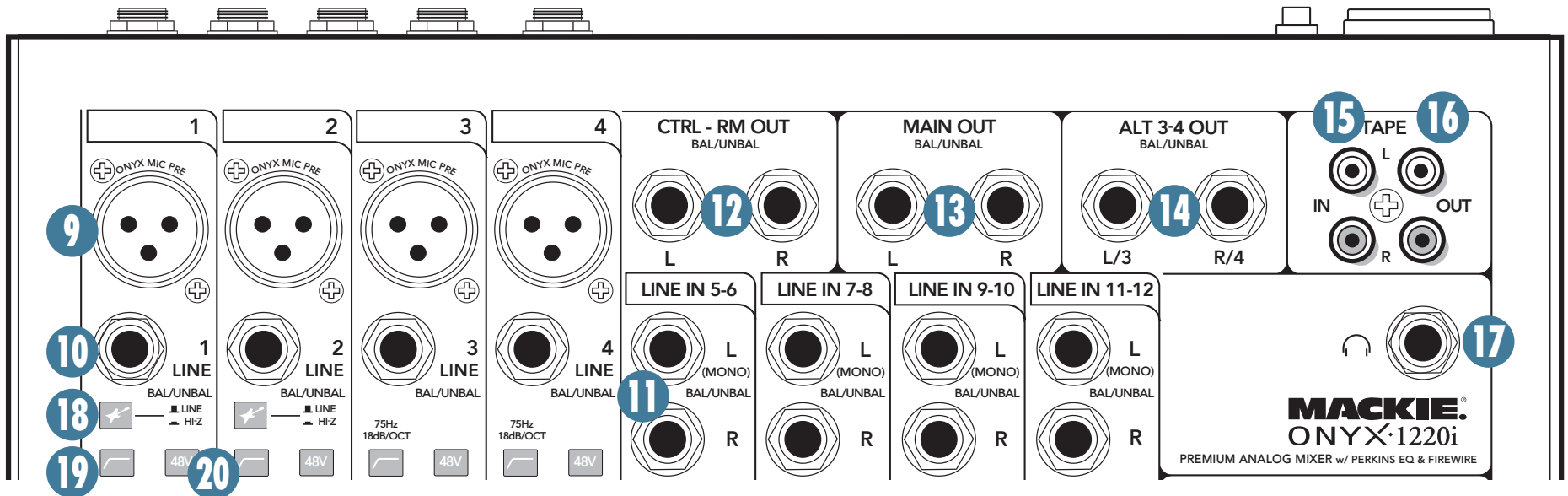

15. TAPE INPUTS

These stereo unbalanced RCA inputs allow you to play a tape, CD player, iPod® dock, or other line-level source. The tape in jacks accept an unbalanced signal using standard hi-fi hookup cables.

Push in the tape button [36] to route the tape input to the control room and phones outputs [12, 17]. This allows you to play back recordings of your mixes.

Push in the assign to main mix button [37] to route the tape input to the main outs [4, 13]. This allows you to play back music between sets over the main PA speakers.



Pushing tape in the source matrix and pushing assign to main mix can create a feedback path between tape in and tape out.

Make sure your tape deck is not in record, record pause, or input monitor mode when you engage these switches, or make sure the control room level control is turned all the way down first.

16. TAPE OUTPUTS

These stereo unbalanced RCA outputs allow you to record the main stereo mix onto a tape deck, hard disk recorder, or automatic CD burner, for example. This lets you make a recording for posterity/archive/legal purposes whenever the band gets back together again.

The tape output is the stereo main mix, and it is affected by the main mix level control [51]. The output could also be used as an extra set of main outputs for feeding another zone.

17. HEADPHONE OUTPUT

This 1/4" TRS connector supplies the output to your stereo headphones. It is the same signal that is routed to the control room outputs [12], as determined by the control room/phones source matrix [35, 36]. The volume is controlled with the phones knob [39], right next to the control room knob [38].

Whenever a solo switch [34] is engaged, you will only hear the soloed channel(s) in the headphones. This gives you the opportunity to audition the channels before they are added to the main mix. (Solo signals reaching the headphones are not affected by the channel level or main level, therefore turn down the phones level first, as soloed channels may be loud.)

The phones output follows standard conventions:

Tip = Left channel

Ring = Right channel

Sleeve = Common ground



WARNING: The headphone amp is loud, and can cause permanent hearing damage. Even intermediate levels may be painfully loud with some headphones. **BE CAREFUL!** Always turn the phones level control [39] all the way down before connecting headphones or pressing a solo switch, or doing anything new that may affect the headphone volume. Then turn it up slowly as you listen carefully.

Channel Controls

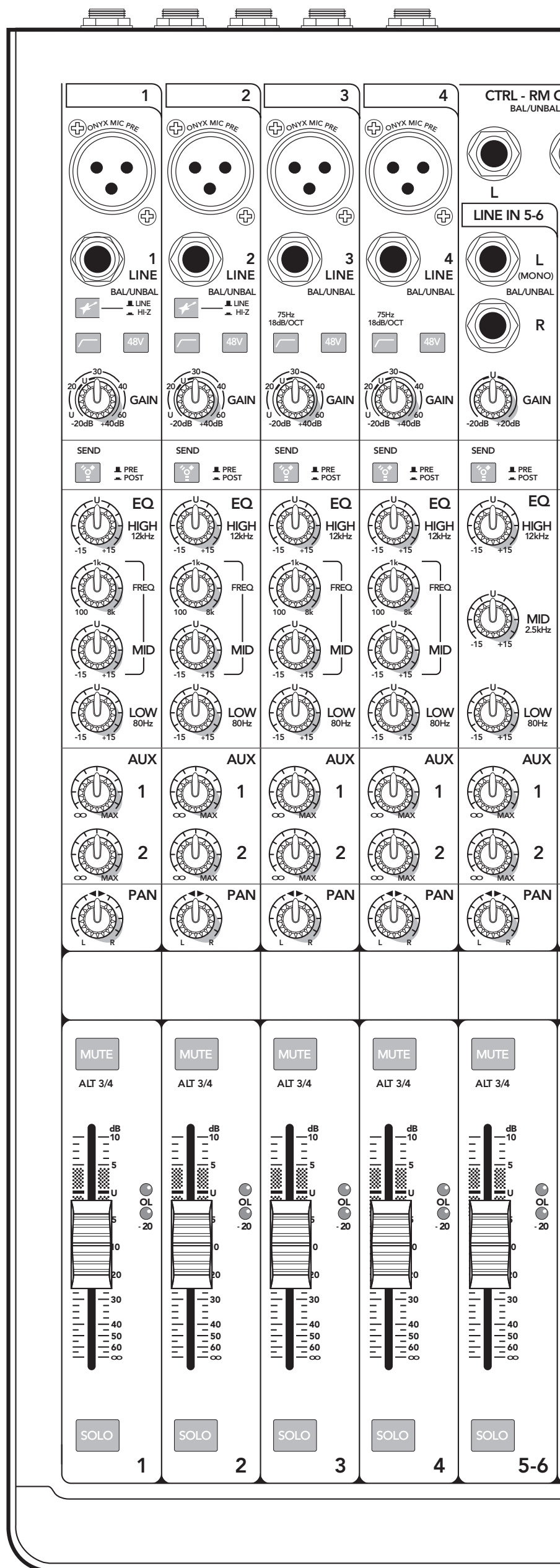

The vertical channel strips look very similar, and have only a few differences between them. Each channel works independently, and just controls the signals plugged into the inputs directly above it.

Here are a few features and differences:

Mono Channels 1-4

- These are mono channels, and their controls affect either the mono mic input or the mono line-level input.
- Channel 1 and 2 each have a hi-z switch, so you can connect guitars directly without the need for a DI box.
- 48 Volt Phantom Power can be selected for each mic input.
- High pass filters affects both the mic and line inputs.
- Gain control adjusts the mic level and line level.
- The 3-band EQ has shelving high, shelving low, and peaking mid EQ with adjustable mid frequency.

Stereo Channels 5-12

- The stereo channels each have two line-level inputs.
- For mono sources, use the left input only, and it will appear equally on both sides of the main mix.
- Gain control adjusts the line level only.
- The 3-band EQ has shelving high, shelving low, and peaking mid EQ.
- Channel 11 and 12 have a switch to select FireWire inputs instead of the analog line inputs.

“U” like Unity gain

Mackie mixers have a “U” symbol on almost every level control. It stands for “unity gain,” meaning no change in signal level. The labels on the controls are measured in decibels (dB), so you’ll know what you’re doing level-wise if you choose to change a control’s settings.

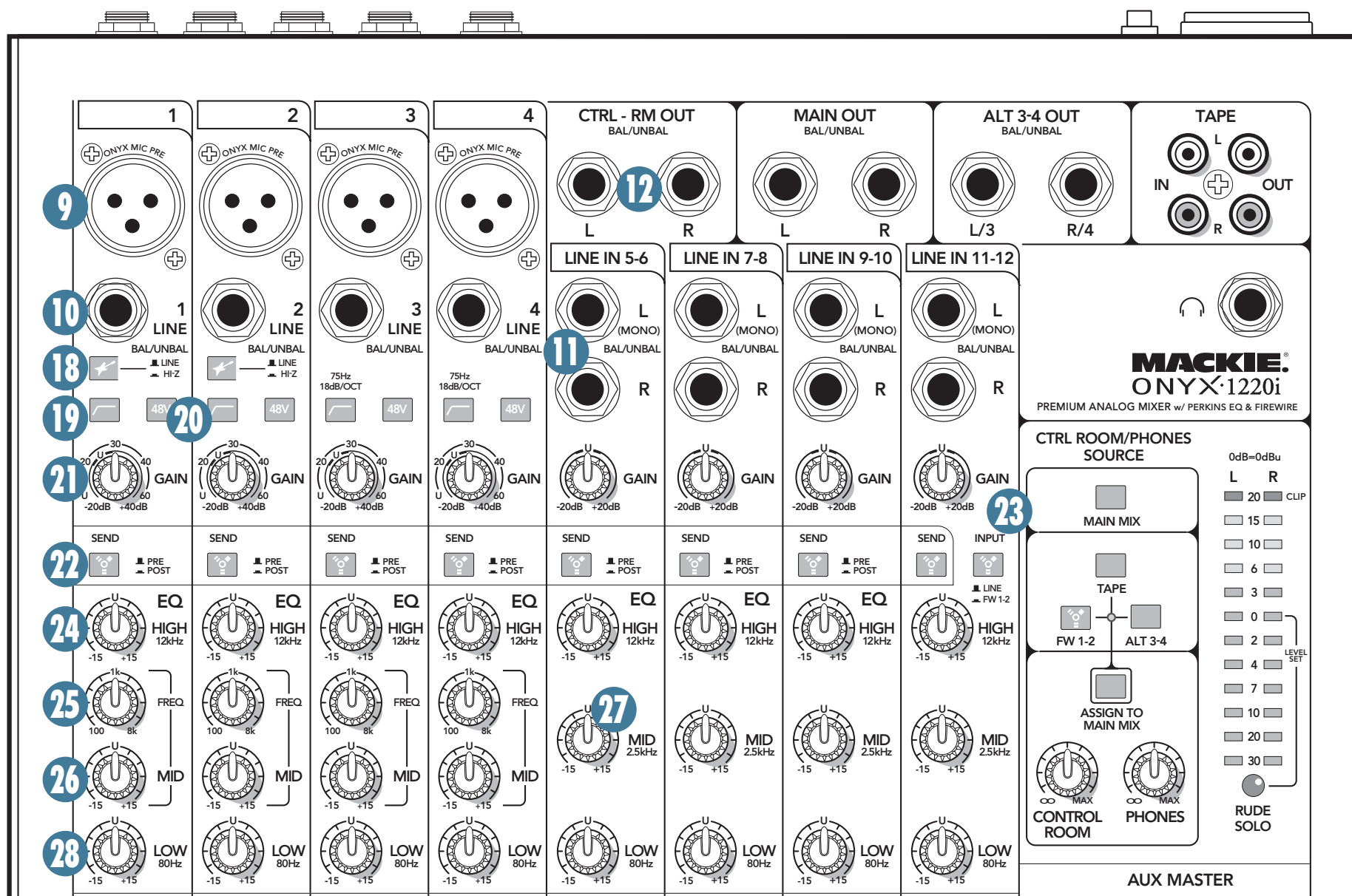

18. HI-Z SWITCH (Ch. 1 and 2 only)

Engage this switch if you want to connect guitars directly to the 1/4" line inputs of channels 1 or 2.

Without this switch, you need to use a DI box first, before connecting guitars. If these switches are not pressed in, guitars will not sound good, particularly the high frequency response.



Plugging a guitar into a lower-impedance line-level input can result in the loss of high frequencies, causing an unnatural and dull sound. Normally, you must use a direct box between a guitar and a mixer's input, which serves to convert the impedance of the guitar from high to low. The hi-z inputs on channels 1 and 2 make the need for a direct box unnecessary. However: The hi-z inputs are unbalanced (when the switch is in), so if you're doing a live show and running a long cord between the instrument and the mixer (say over 25 or 30 feet), it is best to use a direct box with a balanced output to avoid picking up noise over the length of the cord.

19. LOW CUT (Ch.1-4 only)

The mono channels each have a low-cut switch (often referred to as a high-pass filter) that cuts bass frequencies below 75 Hz at a rate of 18 dB per octave.

The low cut switch affects both the mic and line inputs.

We recommend that you use low-cut on every microphone application except kick drum, bass guitar, or bassy synth patches. These aside, there isn't much down there that you want to hear, and filtering it out makes the low stuff you do want much more crisp and tasty. Not only that, but low-cut can help reduce the possibility of feedback in live situations, and it helps to conserve amplifier power.



Another way to consider low-cut's function is that it actually adds flexibility during live performances. With the addition of low-cut, you can safely use low equalization on vocals. Many times, bass shelving EQ can really benefit voices. Trouble is, adding low EQ also boosts stage rumble, mic handling clunks and breath pops from way-down low. Applying low-cut removes all those problems, so you can add low EQ without blowing your subwoofers.

20. 48V PHANTOM POWER (Ch.1–4 only)

Most modern professional condenser mics require 48V phantom power, which lets the mixer send low-current DC voltage to the mic's electronics through the same wires that carry audio. (Semi-pro condenser mics often have batteries to accomplish the same thing.) "Phantom" owes its name to an ability to be "unseen" by dynamic mics (Shure SM57/SM58, for instance), which don't need external power and aren't affected by it anyway.

Press this switch in if your microphone requires phantom power. (Always check the position of this switch before connecting microphones.)



Never plug single-ended (unbalanced) microphones, or ribbon mics into the mic input jacks if phantom power is on. Do not plug instrument outputs into the mic XLR input jacks with phantom power on, unless you know for certain it is safe to do so. Be sure the main level [51] is turned down when connecting microphones to the mic inputs when phantom power is turned on, to prevent pops from getting through to the speakers.

21. GAIN CONTROL

If you haven't already, please read the level-setting procedure on page 3.

The gain knobs adjust the input sensitivity of the mic and line inputs. This allows signals from the outside world to be adjusted to run through each channel at optimal internal operating levels.

If the signal originates through the mic XLR jack, there will be 0 dB of gain with the knob fully down, ramping to 60 dB of gain fully up.

Through the 1/4" line input of channels 1-4, there is 20 dB of attenuation fully down and 40 dB of gain fully up, with unity gain "U" at 11:00.

Through the 1/4" line input of channels 5-12, there is 20 dB of attenuation fully down and 20 dB of gain fully up, with unity gain "U" at 11:00.

This 20 dB of attenuation can be very handy when you are inserting a hot signal, when you want to add EQ gain, or both. Without this "virtual pad," there is more chance of channel clipping.

22. SEND FIREWIRE PRE/POST

Each channel of the mixer can send a FireWire output to your computer or DAW. The FireWire output from each channel can be tapped before (pre) or after (post) the channel EQ. (The output is always pre-fader.)

If you want the mixer EQ to affect the FireWire recording, then set this switch to **post**. This is useful in recording channels in a studio (where the recording includes the beneficial effect of our Perkins EQ).

If you would rather record the straight signals from a live performance, and EQ them later in your DAW, then set this switch to **pre**. This is good for live work, where you may have added EQ to adjust for the room, and yet not want this added to your recording.

23. INPUT (LINE or FW 1-2)

Channel 11 and 12 can either be fed from the 1/4" line level inputs, or by two outputs from a computer via FireWire. This switch lets you choose which to use. Either way, the channels receive line-level analog audio signals just prior to the gain control, so channel setup, gain adjustment and EQ adjustment are the same for line or FireWire. This is useful for virtual instruments that want to be "just another channel" among hardware instruments.

CHANNEL EQUALIZATION (EQ)

There are two different flavors of EQ:

Mono Channels 1-4

3-band EQ with shelving high, shelving low, and peaking mid EQ with adjustable mid frequency.

Stereo Channels 5-12

3-band EQ with shelving high, shelving low, and peaking mid EQ.

Shelving means that the circuitry boosts or cuts all frequencies past the specified frequency. For example, the low EQ boosts bass frequencies below 80 Hz and continuing down to the lowest note you never heard. Peaking means that certain frequencies form a "hill" around the center frequency.



With too much EQ, you can really upset things. We've designed a lot of boost and cut into each equalizer circuit because we know that everyone will occasionally need that. But if you max the EQ on every channel, you'll get mix mush. Equalize subtly and use the left sides of the knobs (cut), as well as the right (boost). If you find yourself repeatedly using a lot of boost or cut, consider altering the sound source, such as placing a mic differently, trying a different kind of mic, a different vocalist, changing the strings, or gargling.

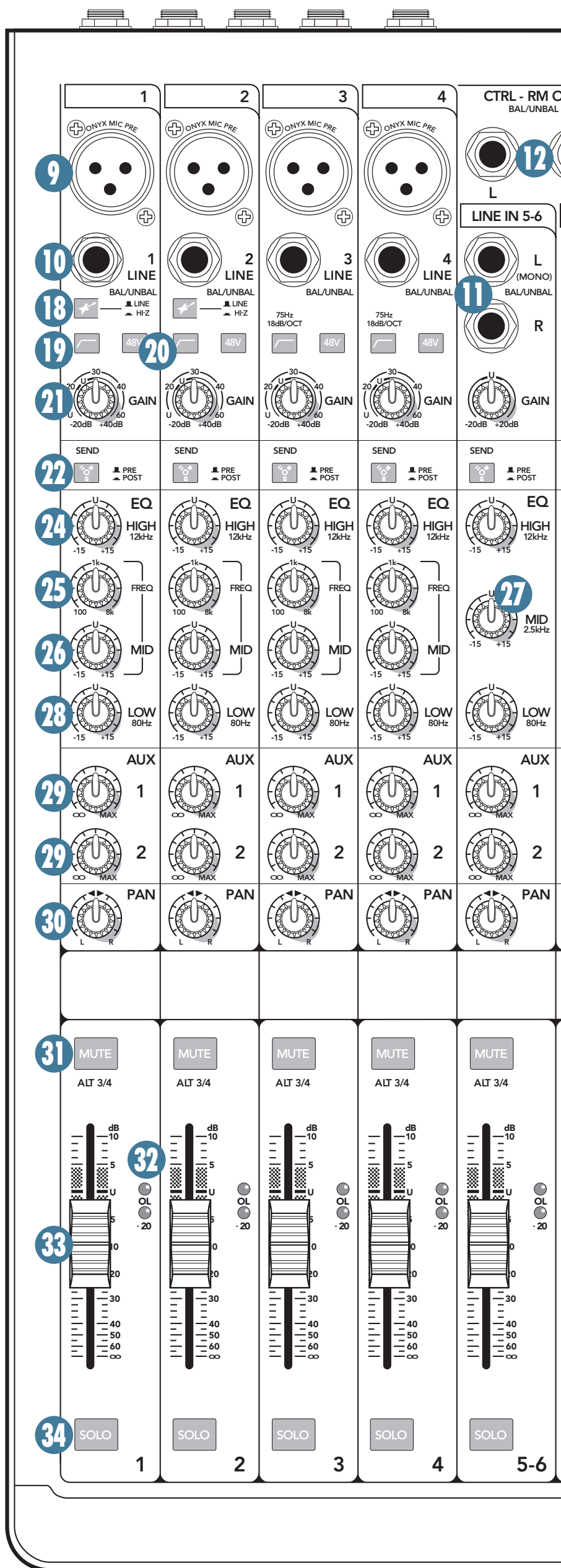

24. HIGH EQ

The high EQ provides up to 15 dB of boost or cut above 12 kHz, and it is also flat (no boost or cut) at the detent. Use it to add sizzle to cymbals, an overall sense of transparency, or an edge to keyboards, vocals, guitar and bacon frying. Turn it down a little to reduce sibilance or to mask tape hiss.

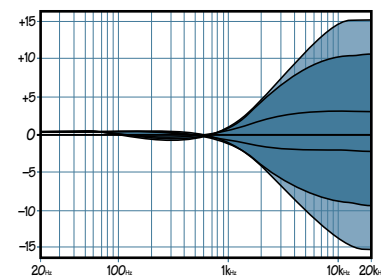

25. MID EQ FREQUENCY (Ch. 1-4)

This knob sets the center frequency of the mid EQ level control [26]. This is sweepable from 100 Hz to 8 kHz.

Once this is set, the mid EQ level can be adjusted with the mid EQ level control.

Most of the root and lower harmonics that define a sound are located in the 100 Hz–8 kHz frequency range, and you can create drastic changes with these two knobs. Many engineers use mid EQ to cut midrange frequencies, not boost them. One popular trick is to set the mid fully up, turn the frequency knob until you find a point where it sounds just terrible, then back the mid down into the cut range, causing those terrible frequencies to disappear. Sounds silly, but it works. Sometimes.

26. MID EQ LEVEL (Ch. 1-4)

The mid EQ provides up to 15 dB of boost or cut, and it is also flat (no boost or cut) at the detent. The frequency at which the cut or boost occurs is set by the mid EQ frequency control [25].

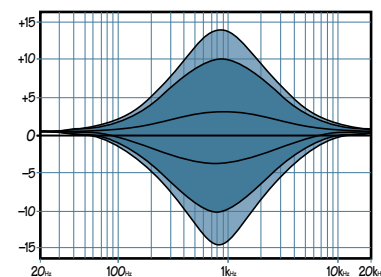

27. MID EQ LEVEL (Ch. 5-12)

The mid EQ provides up to 15 dB of boost or cut at 2.5 kHz, and is flat at the detent.

28. LOW EQ

The low EQ provides up to 15 dB of boost or cut below 80 Hz. The circuit is flat at the center detent position. This frequency represents the punch in bass drums, bass guitar, fat synth patches, and some really serious male singers who eat raw beef for breakfast.

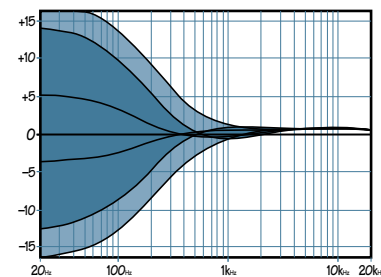

29. AUX SEND 1 and 2

These controls allow you to set up two independent mixes, typically for running stage monitors or external effects processors.

The controls are off when turned fully down, deliver unity gain at the center, and can provide up to 15 dB of gain turned fully up. Chances are that you will never need this extra gain, but it's nice to know it's there if you do.

Aux Send 1 and 2 [6] are line-level outputs, and are used if you want to connect external processors, powered stage monitors, or external power amps with passive stage monitors. Aux Return 1 and 2 [7] are line-level inputs, typically used to return the output from external processors back to the main mix.

Carefully adjust how much of each channel appears in your aux mixes. For example, if you are running stage monitors, and someone wants "more me, and less them," adjust these carefully.

The aux sends can either be pre or post fader, depending on the position of the aux pre/post switches [43]. For stage monitor work, use pre, so the stage monitors do not increase in volume when the channel level is adjusted. For external processors, use post. In this way, the feed to external processors will vary with the channel level, keeping them in the same ratio (wet/dry).

30. PAN

For mono channels 1-4, this control allows you to adjust how much of the channel signal goes to the left main mix, and how much goes to the right main mix. It has no effect on the aux, as these are mono. In the center position, the mono channel is split equally to the left and right.

Pan also affects the channel output to the Alt 3-4 mix if a channel mute switch is engaged.

For channels 5-12, pan acts in a similar way to a home stereo balance control (panning left turns down the right channel, and panning right turns down the left channel).

If you have a stereo source and the mixer's stereo inputs are already taken, connect the source's left output into channel 1, and the right into channel 2. Pan the channel 1 fully left, and channel 2 fully right, then the source will appear in the main mix in full stereo.

The pan control employs a design called "Constant Loudness." If you have a channel panned hard left (or right) and then pan to the center, the signal is attenuated about 3 dB to maintain the same apparent loudness. Otherwise, it would make the sound appear much louder when panned center.

31. MUTE switch and ALT 3-4

The dual-purpose mute/alt 3-4 switch is a Mackie signature. When Greg was designing our first product, he had to include a mute switch for each channel. Mute switches do just what they sound like they do. They turn off the signal by "routing" it into oblivion. "Gee, what a waste," he reasoned. "Why not have the mute button route the signal somewhere else useful, like a separate stereo bus?"

So mute/alt 3-4 really serves two functions—muting (often used during mixdown or live shows), and signal routing (for multitrack and live work) where it acts as an extra stereo bus.

To use this as a mute switch, all you have to do is not use the alt 3-4 outputs [14]. Then, whenever you assign a channel to these unused outputs, you'll also be disconnecting it from the main mix, effectively muting the channel. The mute switch also disconnects the channel from the post-fader aux send bus. The channel's signal is still present on the pre-fader aux send bus, so muting a channel does not affect your stage monitors, and the quiet and gentle disposition of your lead singer.

To use this as an alt 3-4 switch, all you have to do is connect the alt 3-4 outputs to whatever destination you desire. Here are two popular examples:

When doing multitrack recording, you can use the alt 3-4 outputs as a stereo or dual-mono feed to your multitrack.

When doing live sound or mixdown, it's often handy to control the level of several channels with one knob. That's called subgrouping. Simply assign these channels to the alt 3-4 mix, engage alt 3-4 in the control room/phones source matrix [36], and the signals will appear at the control room [12] and phones [17] outputs. If you want the alt 3-4 signals to go back into the main mix, engage the assign to main mix switch [37] and the control room knob [38] will control the levels of all the channels assigned to alt 3-4.

Another way to do the same thing is to assign the channels to the alt 3-4 mix, then patch out of the alt 3-4 out (left/3 and right/4) back into an unused stereo channel (5-12). If that's your choice, don't ever engage the mute/alt 3-4 switch on that stereo channel, or you'll have every dog in the neighborhood howling at your feedback loop.

Another benefit of the alt 3-4 feature is that it can act as an "af" (after fader listen). Just engage a channel's mute/alt 3-4 switch and the alt 3-4 switch in the source matrix and you'll get that channel, all by itself, in the control room and headphones.

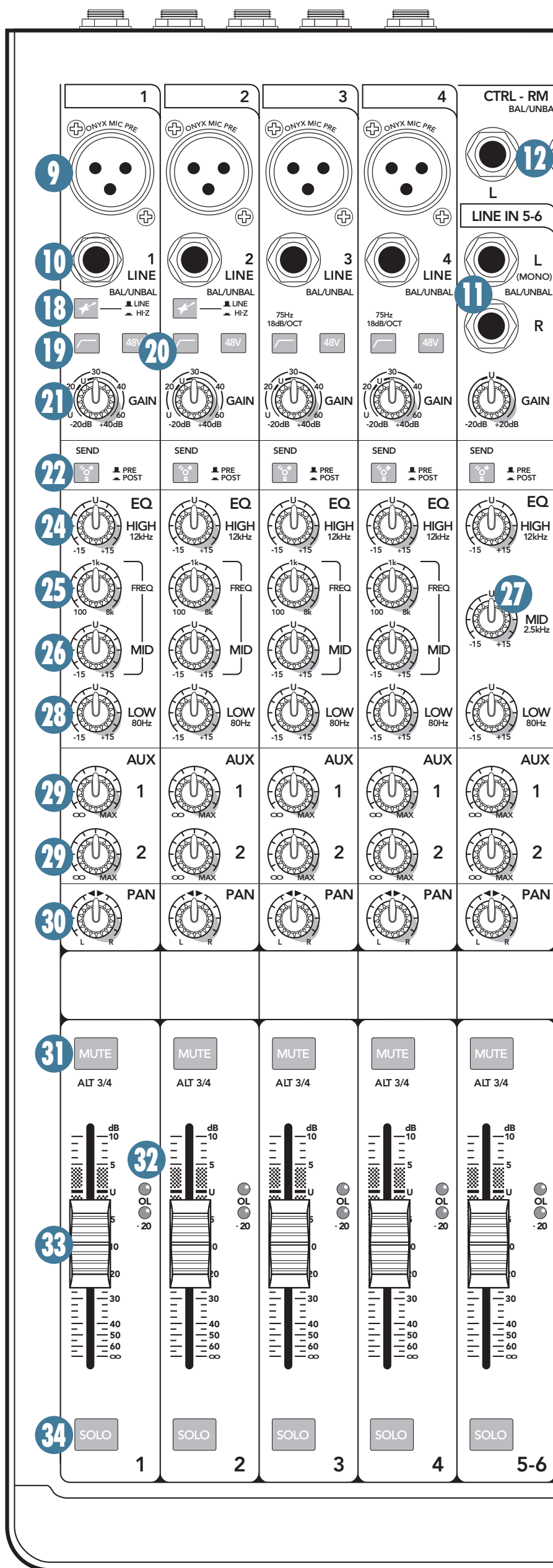

32. -20 and OL LEDs

These LEDs indicate the channel's signal level after the gain and EQ controls, but just before the channel's level. So even if the level is turned down, you can see if a signal is present, or if the channel is being overloaded.

The OL (overload) LED will come on when the channel's input signal is too high. This should be avoided, as distortion will occur. If the OL LED comes on regularly, check that the gain control [21] is set correctly for your input device, and that the channel EQ is not set with too much boost.

The -20 LED comes on when the channel signal strength has reached that level.

33. CHANNEL FADER

This is the last control in a channel's signal path, and it adjusts the level of each channel onto the main mix. The "U" mark indicates unity gain, meaning no increase or decrease of signal level. All the way up provides an additional 10 dB, should you need to boost a section of a song. If you find that the overall level is too quiet or too loud with the level near unity, check that the gain control [21] is set correctly.

34. SOLO

Whenever a solo switch is engaged, you will only hear the soloed channel(s) in the headphones and control room. This gives you the opportunity to audition the channels before they are added to the main mix or alt 3-4 mix. You can still hear, even when the fader is down.

Solo is also used to set the gain of each channel correctly. When a channel is soloed, you can adjust the channel gain [21] until your input source reaches the level of the 0 dB LED of the right meter.



Solo signals reaching the headphones and control room are not affected by the channel level or main level; therefore, turn down the phones level [39] and control room level [38] first, as soloed channels may be loud.

The rude solo light [41] will turn on as a reminder that what you are listening to in the headphones and control room is just the soloed channel(s).

For stereo channels, the mono sum of the left and right is soloed.

Soloed channels are sent to the source mix, which ultimately feeds your control room, phones, and meters. Whenever solo is engaged, all source selections (main mix, alt 3-4, tape, and FireWire) are defeated, to allow the soloed signal to do just that—solo!

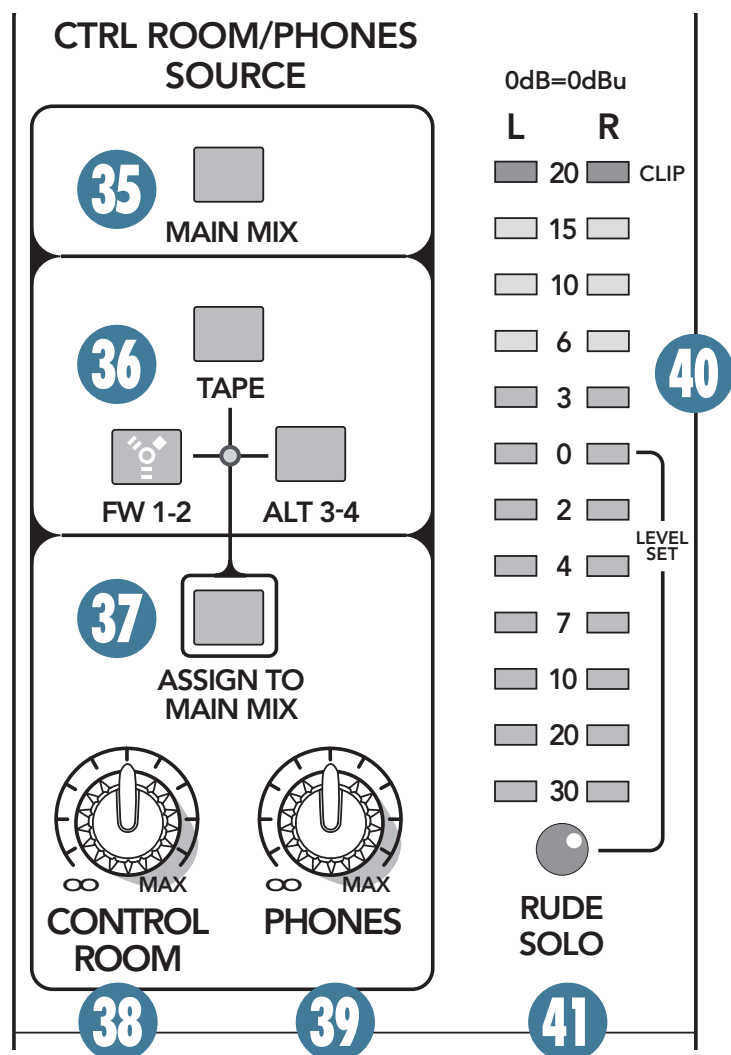

Control Room/Phones and Meters

Typically, the engineer sends the main mix to an audience (for a live show) or to a mixdown deck (if recording). But what if the engineer needs to hear something other than the main mix in the control room or headphones? With the Onyx 1220i, the engineer has several choices of what to listen to. This is one of those tricky parts, so buckle up.

35. MAIN MIX

Press this switch in to listen to the main mix in your control room and headphones, and to check the main mix levels in the meters. In addition to the main mix, you can listen to any combination of tape, FW 1-2 and alt 3-4, depending on which of these switches [36] is engaged.



If the assign to main mix switch [37] is engaged, you cannot hear the main mix in the control room or headphones, or see its level on the meters. This is to prevent feedback caused by sending the main mix to the main mix.

36. TAPE, FW 1-2, ALT 3-4

Using these source switches, you can choose to listen to any combination of tape, FireWire, and alt 3-4 in the control room and headphones, in addition to the main mix if its source switch [35] is engaged.

Tape is the stereo signal coming in from the tape in [15] RCA jacks. FireWire is a 2-track feed coming in through the FireWire [3] connection from your computer. Alt 3-4 is the additional stereo mix bus formed when any channel is muted with the mute/alt 3-4 switch [31].

Selections made here deliver stereo signals to the control room, phones, and meters. With no switches or main mix [35] engaged, there will be no signal at these outputs and no meter indication.

The exception is the solo function. Regardless of the source matrix selection here, engaging a channel's solo switch will replace that selection with the solo signal, sent to the control room, phones, and the right meter.

37. ASSIGN TO MAIN MIX

Let's say you're doing a live show: "You're doing a live show." Intermission is nearing and you want to play a soothing CD for the crowd to prevent them from becoming antsy. Simply engage this switch and your source matrix selection, after going through the control room level control, will feed into the main mix, just as if it were another stereo channel.

What if you have a playlist of MP3 files on your computer you want to play during the break? Engage this switch and the FireWire switch [36] to play your MP3s directly from your computer, through the source matrix, and into the main mix.

Another handy use for this switch is to enable the alt 3-4 mix to become a submix of the main mix, using the control room level control.

Side effects to engaging this switch:

1. It will also feed any soloed channels into the main mix, which may be the last thing you want.
2. If you have main mix as your source matrix selection and then engage this switch, the main mix lines to the source matrix will be disconnected from the control room and phones outputs, to prevent feedback.
3. If you have tape as your source matrix selection, and then engage this switch, it can create a feedback path between tape in and tape out. Make sure your tape deck is not in record, record-pause, or input monitor mode when you engage these switches, or make sure the control room knob [38] is turned all the way down.

38. CONTROL ROOM Knob

This controls the volume at the control room outputs, from off to maximum gain (+10 dB). It also controls the level of the control room signal going to the main outs when assign to main mix [37] is selected.

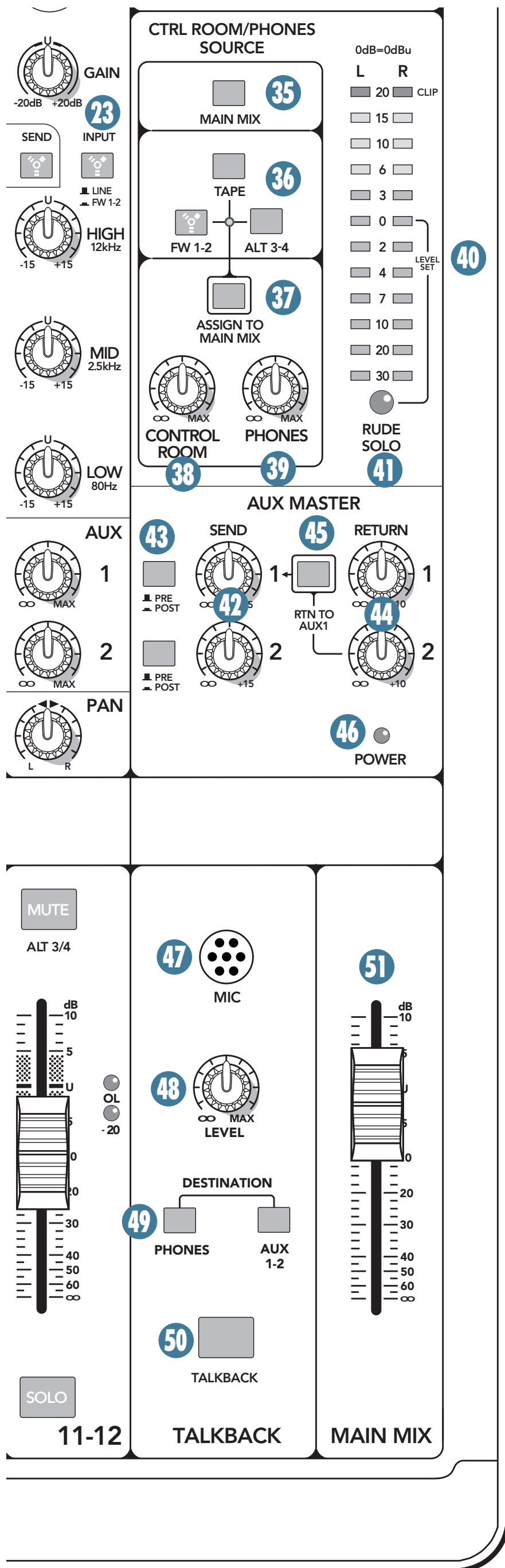

39. PHONES Knob

This controls the volume at the phones output, from off to maximum gain.



WARNING: The headphone amp is loud, and can cause permanent hearing damage. Even intermediate levels may be painfully loud

with some headphones. **BE CAREFUL!** Always turn this control all the way down before connecting headphones, or pressing a solo switch [34], or doing anything new that may affect the headphone volume. Then turn it up slowly as you listen carefully.

40. LEFT/RIGHT Level Meters

These peak meters are made up of two columns of twelve LEDs, with three colors to indicate different ranges of signal level, traffic light style. They range from -30 at the bottom, to 0 in the middle, to +20 (CLIP) at the top.

If no source [35, 36] is selected in the control room/phones, and no channels are in solo, the meters won't do anything. To display signal levels, select one or more of the sources. For example, press main mix [35] to show the main mix level in the meters. While the listening levels are controlled by the control room and phones knobs, the meters indicate the source mix before these knobs, giving you the real facts at all times, even if you're not listening at all.

When a channel is soloed, the left meter shows no reading, and the right meter shows the level of that channel's signal level, pre-fader. The right meter's 0 dB LED is labeled "level set" to show where the level should be when adjusting a channel's gain [21] in the solo mode (as described in "Set the Levels" on page 3).

When 0 dBu (0.775 V) is at the main mix outputs, it shows as 0 dB on the meters.

You can get a good mix with peaks flashing anywhere between -20 and +10 dB on the meters. Most amplifiers clip at about +10 dBu, and some recorders aren't so forgiving either. For best real-world results, try to keep your peaks between "0" and "+6." Remember, audio meters are just tools to help assure you that your levels are "in the ballpark." You don't have to stare at them (unless you want to).

41. RUDE SOLO Light

This large LED flashes when one or more channel solo switches are engaged [34]. This acts as a reminder that what you hear in the control room and headphones is the soloed channel(s). If you forget you're in solo mode, you can easily be tricked into thinking that something is wrong with your mixer. Hence, the rude solo light. Please forgive its rudeness, it is only trying to help, and wants to be your friend.

Aux Master

This section includes the aux sends and the aux returns. Aux sends tap signals off the channels, via the aux knobs [29], mix these signals from each channel together, then sends them out the aux send jacks [6] and FireWire outputs 11 and 12. The aux sends can be pre-fader or post-fader (both are post-EQ, but see page 38).

Post-fader aux sends can be fed to the inputs of an external processor like a reverb or digital delay. From there, the outputs of this external processor are fed back to the mixer's aux return jacks [7]. Then these signals are sent through the aux return level controls [44], and finally delivered to the main mix.

So, the original unprocessed "dry" signals go from the channels to the main mix, and the processed "wet" signals go from the aux returns to the main mix, and once mixed together, the dry and wet signals combine to create a glorious sound!

Pre-fader aux sends are typically used to provide another mix for stage monitors. In this case, the aux returns aren't used to return the signal. Instead, they can be used as additional stereo inputs, or not used at all.

42. MASTER AUX SEND 1 and 2

These knobs provide overall control over the aux send levels, just before they are delivered to the aux send outputs [6]. These knobs go from off to +15 db when turned all the way up.

The aux sends can either be pre or post fader, depending on the position of the aux pre/post switches [43].

This is usually the knob you turn up when the lead singer glares at you, points at his stage monitor, and sticks his thumb up in the air. (It would follow that if the singer stuck his thumb down, you'd turn the knob down, but that never happens.)

The aux sends are also sent to FireWire output 11 and 12 for recording. The levels to FireWire are affected by these send controls and the pre/post switch.

43. PRE/POST

The pre/post switches determine whether the aux send signal is tapped from the channels before the channel level controls (pre-fader) or after (post-fader). Having a separate pre/post switch for each aux is a super-useful feature as it allows the use of one effects processor and one stage monitor chain, at the same time.

For stage monitor work, use pre, so the stage monitors do not increase in volume when the channel level is adjusted.

For external processors, use post. In this way, the feed to external processors will vary with the channel level, keeping them in the same ratio, so that the "wet" signal level follows the "dry" signal level.

44. MASTER AUX RETURN 1 and 2

These two controls set the overall level of effects received from the stereo aux return 1 and 2 inputs [7]. These controls range from off to +10 db of gain when fully clockwise, to compensate for low-level effects.

Signals passing through these controls go directly to the main mix bus where they are combined with the other channels. Alternatively, the aux 2 return can be routed to aux 1 send instead, using the rtn to aux 1 switch [45] described next.

45. RTN TO AUX 1

This switch routes the signal from aux return 2 to the aux 1 send mix instead of to the main mix bus.

For example, this allows you to use an external effects device, like a reverb or delay, exclusively for the monitors. When this switch is pushed in, the effects signals coming into the aux return 2 jacks are added to your aux 1 stage monitor mix. Adjust the effects level coming in with the aux 2 return controls [44], until it sounds just right in your monitors.

AUX SEND 1-2 and FIREWIRE

A copy of the aux send 1 and 2 outputs is always available via FireWire to send to a computer. The FireWire output is affected by the channel aux send and master aux send controls. For example, you can set up a software effects processor as follows:

- Set up an aux send in post mode.
- FireWire outputs 11 and 12 are always available to send aux send 1 and 2 to your computer.
- Pass this through a software effects processor or plug-in of your choice.
- Return the processed output from the effects processor to mixer channels 11 and 12 (input switch [23] set to FW 1-2).
- Alternatively bring the processed sounds into the control room matrix (engage FW 1-2 [36]) and add it to the main mix (engage assign to main mix [37]).
- You can even use the computer as two separate independent mono in, stereo out processors. Have aux 1 go into one plug-in, and aux 2 go into a different one. The stereo outputs of both plug-ins are combined back into the stereo stream coming back to the mixer.

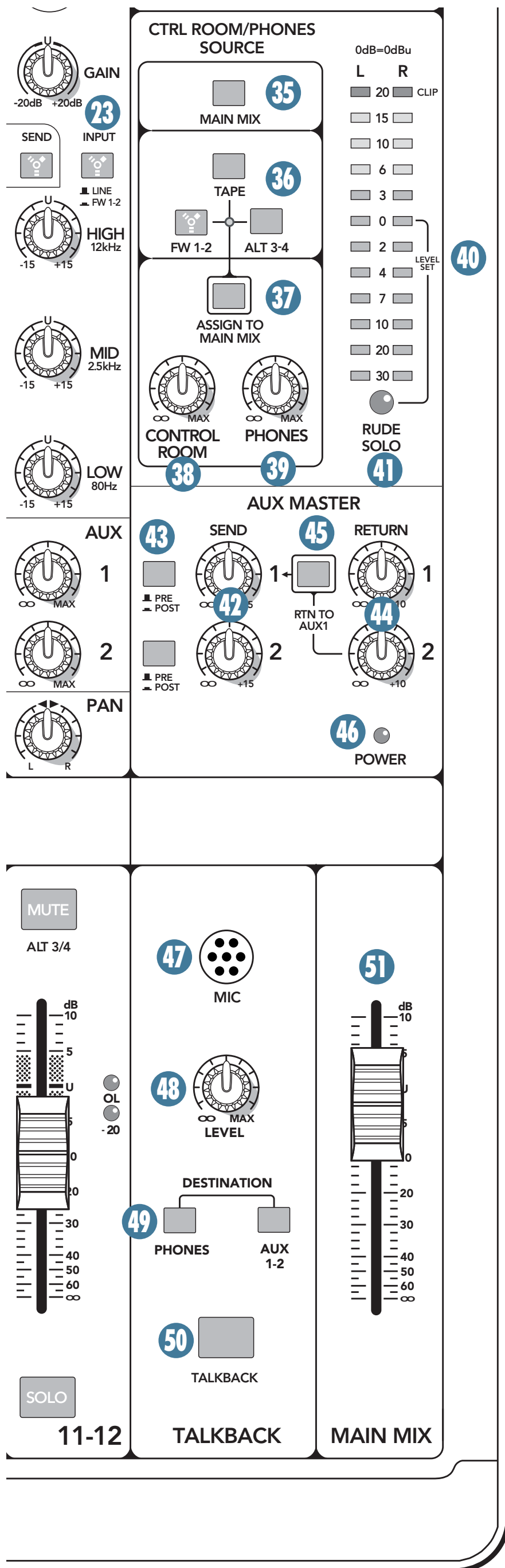

46. POWER LED

This green LED will turn on when the mixer is turned on, as a reminder of how on it really is. If it is not on, then it is off, and the mixer becomes a rather nice weight for keeping your morning newspaper from blowing away in the wind.

If it does not turn on, make sure the power cord is correctly inserted at both ends, the local AC mains supply is active, and the power switch [2] is on.

Talkback

The talkback feature allows the engineer to communicate with the talent either through the phones outputs [17] or the aux 1-2 send outputs [6] using the built-in talkback microphone. This saves a lot of shouting over the audience's heads as you set up the talented one's stage monitors to their peculiarly-picky satisfaction.

47. TALKBACK MIC

This is where the built-in talkback microphone is located. It is an omni-directional dynamic microphone, and it will pick up your voice from anywhere in front of the mixer.

48. TALKBACK LEVEL

Use this knob to control the level of the talkback signal being routed to the phones or aux 1-2 outputs, from the internal microphone.

1. Start with this control turned down.
2. Select the destination, either headphones and/or aux 1-2, and make sure their levels are already set nicely, such as phones [39] or aux sends [42].
3. Hold down the talkback switch [50] as you make your fruity-toned announcements.
4. Slowly turn this talkback level control up until you get confirmation from whoever is listening to headphones or monitors that they can hear and obey your every command.

Once you have set the level, you can leave it there for the duration of the session or gig.

49. DESTINATION: PHONES, AUX 1-2

Push in the phones switch to route the talkback signal to the headphones. Use this to communicate with the talent in the studio through the headphones during a recording session. When the talkback circuit is activated by pushing the talkback [50] switch, the control room outputs [12] are attenuated to allow your voice to come through clearly.

The aux 1-2 switch routes the talkback signal to the aux send 1 and 2 outputs [6]. Use this to communicate with the musicians through their stage monitors when you are setting up a live performance.

It is fine to have both destination switches pushed in at the same time, so the talkback signal will be routed to both destinations. But if you don't have either of the destination switches pushed in, the talkback signal won't go anywhere. You might as well be talking to a brick wall.

50. TALKBACK Switch

This is a momentary switch, and as long as you hold it down, talkback is activated. You can talk into the built-in microphone and be heard in the headphones and/or stage monitors.

Release the switch so you can talk about the band without them hearing you.

Main Mix

51. MAIN MIX

This stereo fader allows you to adjust the levels of the main mix signals sent to the XLR and 1/4" main line-level outputs [4, 13], and the tape outputs [16].

This gives you the ultimate feeling of power and control over the sound levels sent to your audience. If you press the main mix switch [35], you can see the main mix levels in the meters [40]. Adjust this control carefully, with your good eye on the meters to check against overloading, and your good ear to the levels to make sure your audience (if any) is happy.

This fader does not affect the aux send outputs [6], alt 3-4 outputs [14], or the main mix FireWire outputs 11-12. It affects the control room or headphones if the main mix switch [35] is engaged.

The main mix signals are off with the fader fully down, the "U" marking is unity gain, and fully up provides 10 dB of additional gain. This additional gain will typically never be needed, but once again, it's nice to know that it's there. The fader is stereo, as it affects both the left and right of the main mix equally. This is the ideal control to slowly bring down at the end of a song (or quickly in the middle of a song if the need ever arises).

MAIN MIX and FIREWIRE

The left and right main mix are permanently assigned to FireWire outputs 11 and 12. For example, you can record the live performance main mix onto your computer. This does not affect the analog main mix outputs.

The output level to your computer is not affected by the main mix fader [51].

Congratulations! You've just read about all the features of your mixer. Time for a frosty beverage.

Appendix A: Service Information

If you think your mixer has a problem, please check out the following troubleshooting tips and do your best to confirm the problem. Visit the Support section of our website (www.mackie.com) where you will find lots of useful information such as FAQs, documentation and any updated PC drivers etc. You may find the answer to the problem without having to send your mixer away.

Troubleshooting

Bad Channel

- Is the channel EQ set up nicely?
- Is the channel gain set correctly?
- Is the channel level up enough?
- Is the channel OL led on?
- Is the channel pan set in the middle?
- Are the hi-z instrument switches set OK for any guitars connected to channels 1 or 2?
- Try unplugging any insert devices from the insert jacks on channels 1-4.
- Try the same source signal in another channel, set up exactly like the suspect channel.
- Is phantom power required for your microphone?

Bad Output

- Is the main level turned up?
- Are the EQs set to reasonable levels?
- Are any aux returns maxed out?
- Unplug anything from the other line-level outputs, such as alt 3-4, control room out, just in case one of your external pieces has a problem.
- Make sure that you are not overdriving your amplifiers. Check the loudspeaker average load impedance is not less than the minimum your amplifier can handle. Check the speaker wiring.

Noise

- Turn the channel gains down, one by one. If the sound disappears, it's either that channel or whatever is plugged into it, so unplug whatever that is. If the noise disappears, it's from your whatever.

Power

- The power LED should come on if the mixer is connected to a suitable live AC mains outlet, and the power switch is on. Check to make sure that the power cord is securely plugged in.

Repair

For warranty service, refer to the warranty information on page 40.

Non-warranty service for Mackie products is available at a factory-authorized service center. To locate your nearest service center, visit www.mackie.com, click "Support" and select "Locate a Service Center." Service for Mackie products living outside the United States can be obtained through local dealers or distributors.

If you do not have access to our website, you can call our Tech Support department at 1-800-898-3211, Monday-Friday, normal business hours, Pacific Time, to explain the problem. Tech Support will tell you where the nearest factory-authorized service center is located in your area.

Appendix B: Connections

"XLR" Connectors

Mackie mixers use 3-pin female "XLR" connectors on all microphone inputs, with pin 1 wired to the grounded (earthed) shield, pin 2 wired to the "high" ("hot" or positive polarity) side of the audio signal and pin 3 wired to the "low" ("cold" or negative polarity) side of the signal. See Figure A.

Use a male "XLR"-type connector, usually found on the nether end of what is called a "mic cable," to connect to a female XLR jack.

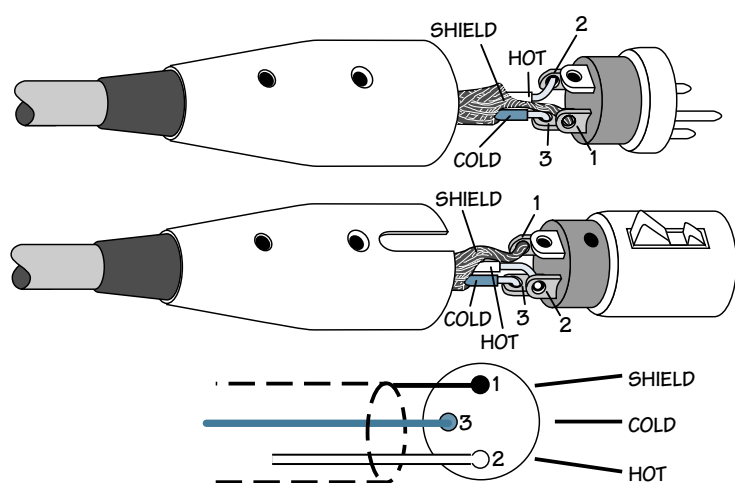

Figure A: XLR Connectors

1/4" TRS Phone Plugs and Jacks

"TRS" stands for Tip-Ring-Sleeve, the three connections available on a "stereo" 1/4" or "balanced" phone jack or plug. See Figure B.

TRS jacks and plugs are used in several different applications:

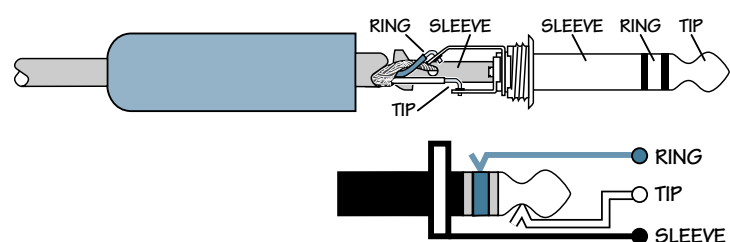

Figure B: 1/4" TRS Plugs

- Balanced mono circuits. When wired as a balanced connector, a 1/4" TRS jack or plug is connected tip to signal high (hot), ring to signal low (cold), and sleeve to ground (earth).
- Stereo Headphones, and rarely, stereo microphones and stereo line connections. When wired for stereo, a 1/4" TRS jack or plug is connected tip to left, ring to right and sleeve to ground (earth). Mackie mixers do not directly accept 1-plug-type stereo microphones. They must be separated into a left cord and a right cord, which are plugged into two mic preamps.

- Unbalanced Send/Return circuits. When wired as send/return "Y" connector, a 1/4" TRS jack or plug is connected tip to signal send (output from mixer), ring to signal return (input back into mixer), and sleeve to ground (earth).

1/4" TS Phone Plugs and Jacks

"TS" stands for Tip-Sleeve, the two connections available on a "mono" 1/4" phone jack or plug. See Figure C.

TS jacks and plugs are used in many different applications, always unbalanced. The tip is connected to the audio signal and the sleeve to ground (earth). Some examples:

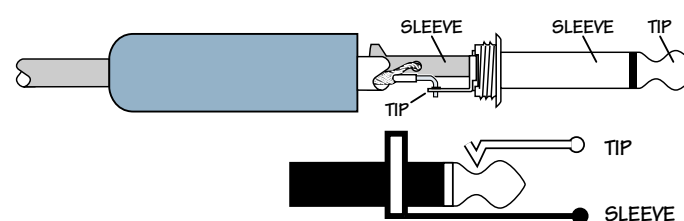

Figure C: TS Plug

- Unbalanced microphones
- Electric guitars and electronic instruments
- Unbalanced line-level connections
- Speaker connections



Don't use guitar cords for speaker cables! They're not designed to handle speaker-level signals and could overheat.

RCA Plugs and Jacks

RCA-type plugs (also known as phono plugs) and jacks are often used in home stereo and video equipment and in many other applications (Figure D). They are unbalanced and electrically identical to a 1/4" TS phone plug or jack. See Figure C. Connect the signal to the center post and the ground (earth) or shield to the surrounding "basket."

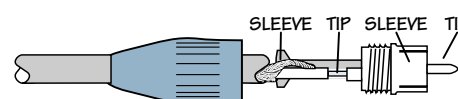

Figure D: RCA Plug

(Figure E does not appear in this owner's manual, due to a contractual obligation, but performs nightly at the downtown Woodinville Cocoa Rooms and Tea Bar.)

TRS Send/Receive Insert Jacks

Mackie's single-jack inserts are the three-conductor, TRS 1/4" phone type. They are unbalanced, but have both the mixer output (send) and the mixer input (return) signals in one connector. See Figure F.

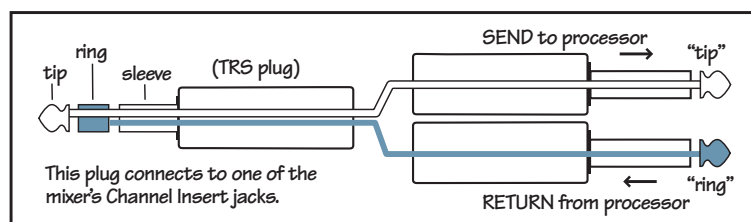

Figure F

The sleeve is the common ground (earth) for both signals. The send from the mixer to the external unit is carried on the tip, and the return from the unit to the mixer is on the ring.

Using the Send-only on an Insert Jack

If you insert a TS (mono) 1/4" plug only partially (to the first click) into a Mackie insert jack, the plug will not activate the jack switch and will not open the insert loop in the circuit (thereby allowing the channel signal to continue on its merry way through the mixer).

This allows you to tap out the channel signal without interrupting normal operation.

If you push the 1/4" TS plug in to the second click, you will open the jack switch and create a direct out, which does interrupt the signal in that channel. See Figure G.

NOTE: Do not overload or short-circuit the signal you are tapping from the mixer. That will affect the internal signal.

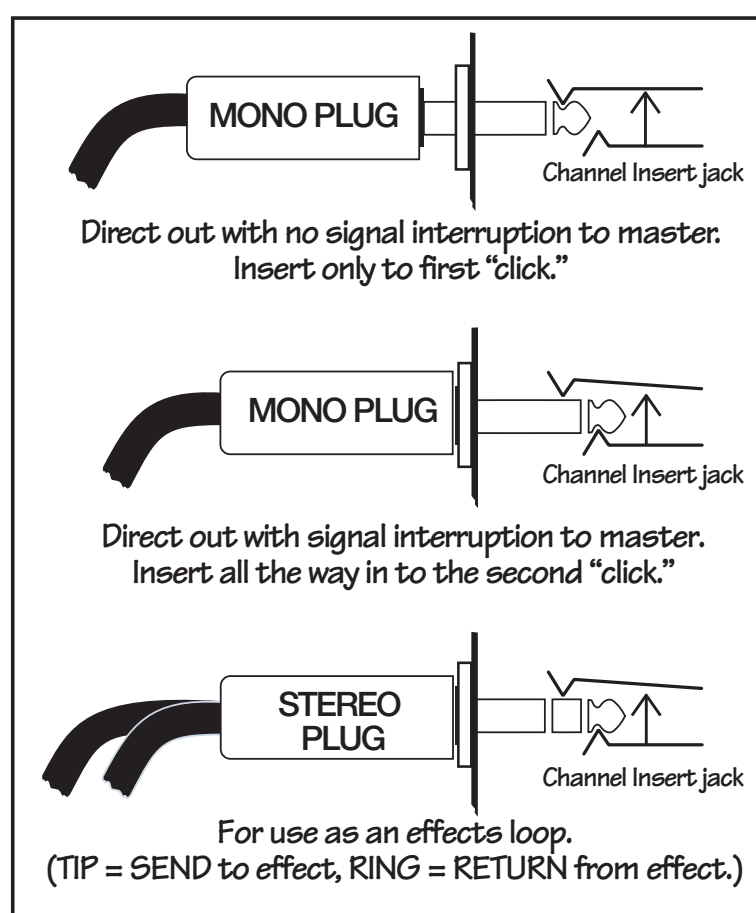

Figure G

Appendix C: Technical Information Specifications

Noise Characteristics:

Equivalent Input Noise (EIN), mic input at insert, 150 Ω source impedance, 20 to 20 kHz:

60 dB (max) gain:	-127 dBu
40 dB gain:	-126.5 dBu

Equivalent Input Noise (EIN), mic input at insert, 50 Ω source impedance, A-weighted:

60 dB (max) gain:	-130.5 dBu
40 dB gain:	-130 dBu

Output Noise Figure (1/4" Main out, all channels assigned to main, Gain knobs at unity, 20 Hz to 30 kHz):

Main Mix knob down, channel Level knobs down:
-102 dBu (-106 dB SNR, ref +4 dBu)

Main Mix knob unity, channel Level knobs down:
-96 dBu (-100 dB SNR, ref +4 dBu)

Main Mix knob unity, channel Level knobs unity:
-93 dBu (-97 dB SNR, ref +4 dBu)

FireWire Through (Record + Playback) Dynamic Range:
0 dBu mic input, to DAW, routed back to mixer direct to Control Room, all gain stages unity, 20 Hz to 20 kHz:

44.1 kHz sample rate:	-104 dB
96 kHz sample rate:	-106.5 dB

Frequency Response:

Mic input to any output (all gain stages at unity):
+0/-0.5 dB,
20 Hz to 20 kHz

Stereo channel line input to any output (all gain stages unity):
+0/-0.5 dB,
20 Hz to 20 kHz

FireWire in and out (mic input to FireWire send, returned to Control Room, all gain stages at unity):

44.1 kHz sample rate:	+/-0.5 dB, 20 Hz to 20 kHz -3 dB at 21 kHz
96 kHz sample rate:	+/-0.5 dB, 20 Hz to 20 kHz -3 dB at 45 kHz

Distortion (THD+N):

20 Hz to 20 kHz, 20 Hz to 80 kHz bandwidth

Mic input at insert
(+4 dBu in, 0 dB gain, +4 dBu out): 0.0015%

Mic input at insert
(-36 dBu in, +40 dB gain, +4 dBu out): 0.017%

Stereo channel line input to any output
(+4 dBu in, all gain stages at unity +4 dBu out): 0.005%

FireWire in and out (+4 dBu in, mic input to FireWire send, returned to Control Room, all gain stages at unity):
44.1 kHz sample rate: 0.01%, 20 Hz to 2 kHz
0.02%, 2 kHz to 20 kHz
96 kHz sample rate: 0.01%, 10 Hz to 1 kHz
0.03%, 1 kHz to 47 kHz

Attenuation and Crosstalk:

@ 1 kHz relative to 0 dBu

Main Mix knob down:	-85 dBu
Channel Alt/Mute switch engaged:	-95 dBu
Channel Level knob down:	-95 dBu

Common Mode Rejection Ratio (CMRR):

Mic input to insert, max gain, 1 kHz, 150 ohm termination:
-70 dB

Maximum Input Levels:

Mic input, gain at min (0 dB):	+22 dBu
Mic input, gain at max (60 dB):	-38 dBu
Line input, gain at -20 dB:	+22 dBu
Instrument input, gain at -20 dB:	+22 dBu
Tape input:	+12 dBu
Aux return:	+22 dBu

Maximum Output Levels:

All outputs:	+22 dBu
--------------	---------

Equalization

Mono Channels

Low:	±15 dB at 80 Hz
Mid frequency:	100 Hz to 8 kHz
Mid gain:	±15 dB
High:	±15 dB at 12 kHz

Stereo Channels:

Low:	±15 dB at 80 Hz
Mid:	±15 dB at 2.5 kHz
High:	±15 dB at 12 kHz

FireWire

Sample Rates Available:	44.1 kHz, 48 kHz, 88.2 kHz, 96 kHz
Buffer Size:	32 (44.1 kHz and 48 kHz only), 64, 128, 256, 512, 1024, 2048 samples
Resolution:	24-bit

Meters

2-segment pre-fader channel meters:	OL (+18 dBu), -20 dBu
12-segment pre-fader Control Room meters:	OL (+20 dBu), +15, +10, +6, +3, 0, -2, -4, -7, -10, -20, -30 (0 VU = 0 dBu)

Input Impedance:

Mic input:	2.8 k Ω balanced
Hi-Z input:	1 M Ω unbalanced
Mono channel line input:	30 k Ω balanced 15 k Ω unbalanced
Stereo Channel line input:	20 k Ω balanced 10 k Ω unbalanced

Output Impedance:

Main XLR output:	100 Ω balanced
Phones output:	75 Ω
All other outputs:	300 Ω

AC Power Requirements:

Power Consumption:	30 Watts
Universal AC Power Supply:	100 VAC – 240 VAC, 50-60 Hz

Physical Dimensions and Weight

Height:	16.75 in/420 mm
Width:	12.25 in/310 mm
Depth:	3.85 in/96 mm
Weight:	13.5 lb/6 kg

Options:

Rack Mount Kit

LOUD Technologies Inc. is always striving to improve our products by incorporating new and improved materials, components, and manufacturing methods. Therefore, we reserve the right to change these specifications at any time without notice.

“Mackie,” and the “Running Man” are registered trademarks of LOUD Technologies Inc. All other brand names mentioned are trademarks or registered trademarks of their respective holders, and are hereby acknowledged.

The technical writer responsible for this manual tends to fade in and out of various different realities, depending on how many cups of tea he has had. Please check our website for any updates to this manual, or updates to the PC drivers: www.mackie.com.

©2010 LOUD Technologies Inc. All Rights Reserved.

Dimensions

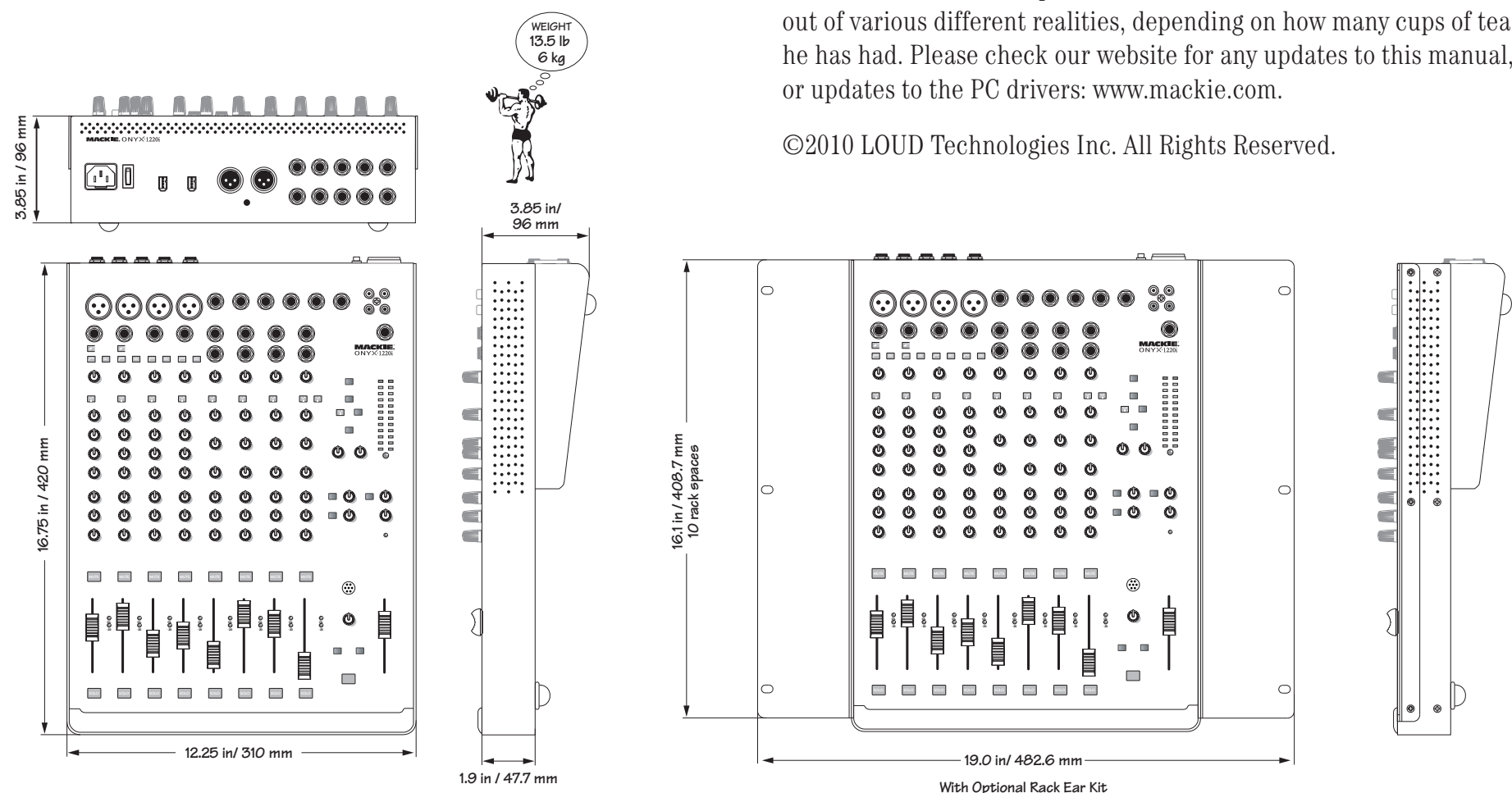

Need help with your new mixer?

- Visit www.mackie.com and click Support to find: FAQs, manuals, addendums, and other useful information.
- Email us at: techmail@mackie.com.
- Telephone 1-800-898-3211 to speak with one of our splendid technical support chaps (Monday through Friday, normal business hours, PST).

Block Diagram

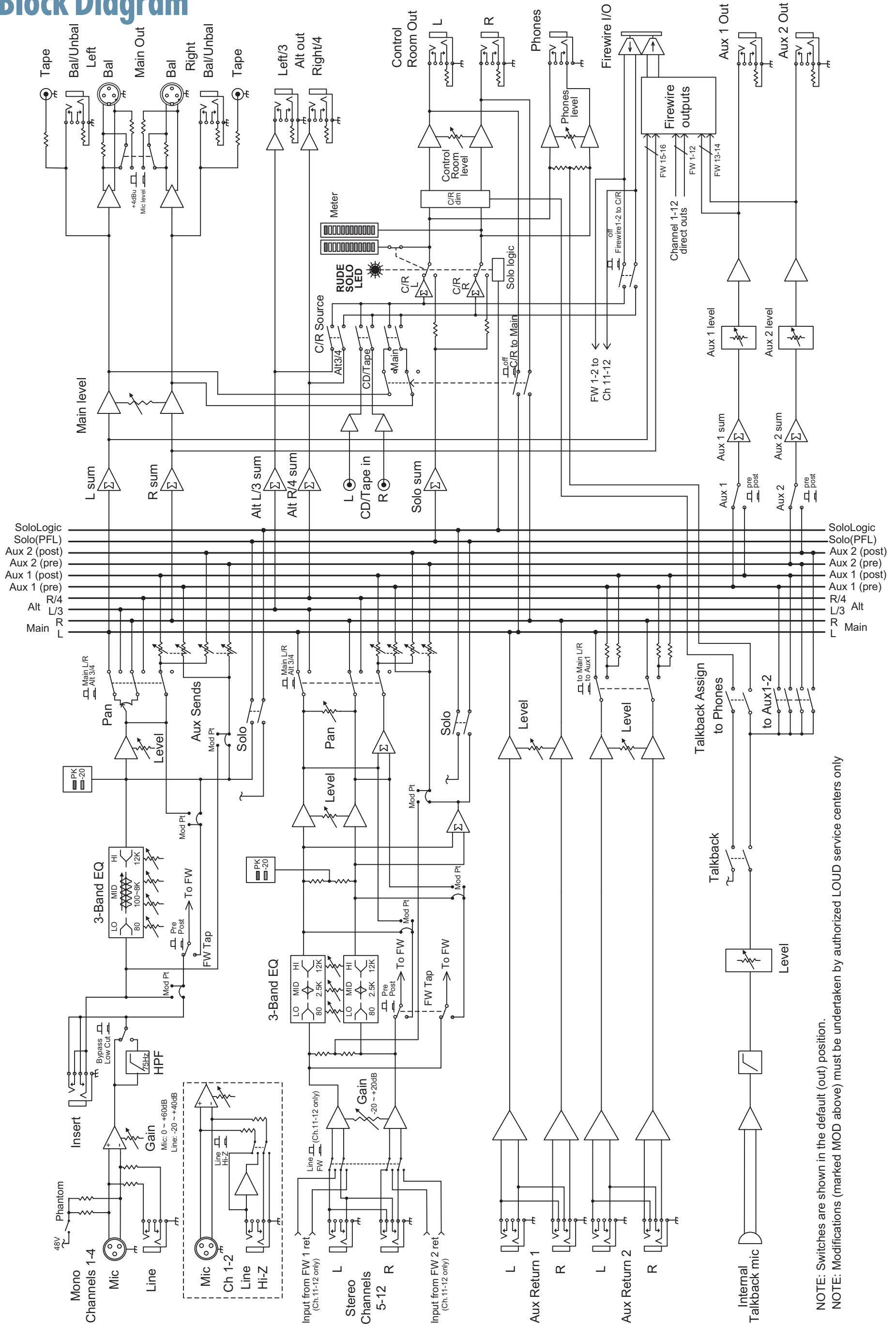

NOTE: Switches are shown in the default (out) position.
 NOTE: Modifications (marked MOD above) must be undertaken by authorized LOUD service centers only

Appendix D: Rack Ear installation instructions

The optional Rack Ear Kit allows the Onyx 1220i mixer to be mounted in a standard 19" rack. It will be out of harm's way and the band may continue tearin' it up without fearing any consequences. The mixer takes up ten rack spaces. Be sure to allow for an extra space or two above to make connections. The kit contains two rack ear brackets and six black screws (M3.5 x 8mm).

Tools Required:

One phillips screwdriver, a comfy chair, a bowl of cereal with milk and bananas (or strawberries, your choice), toast, and a glass of orange juice (optional).

Procedure:

1. Turn off the mixer and disconnect all cords.
2. Place the mixer face up on a soft and dry flat surface.
3. Remove the six silver screws as shown below, place them in the shoe box housing all of those old baseball cards, and keep them in a safe place for further use.
4. Using only the new screws supplied, secure the rack ear brackets to each side of the mixer as shown. Hand-tighten the screws securely. The brackets are NOT identical. The right side bracket has an 'R' on the inside of the bracket flange (see drawing below).
5. Offer up the mixer to the rack and secure it in place with four rack screws (not supplied). Remember to leave enough room at the top to attach the AC power cord and any other connections needed.
6. Relax, you did it! Break out the cereal, frosty glass of orange juice, the buttered-just-right toast, and plant your bottom on that comfy chair of yours and enjoy the sweet taste of success!

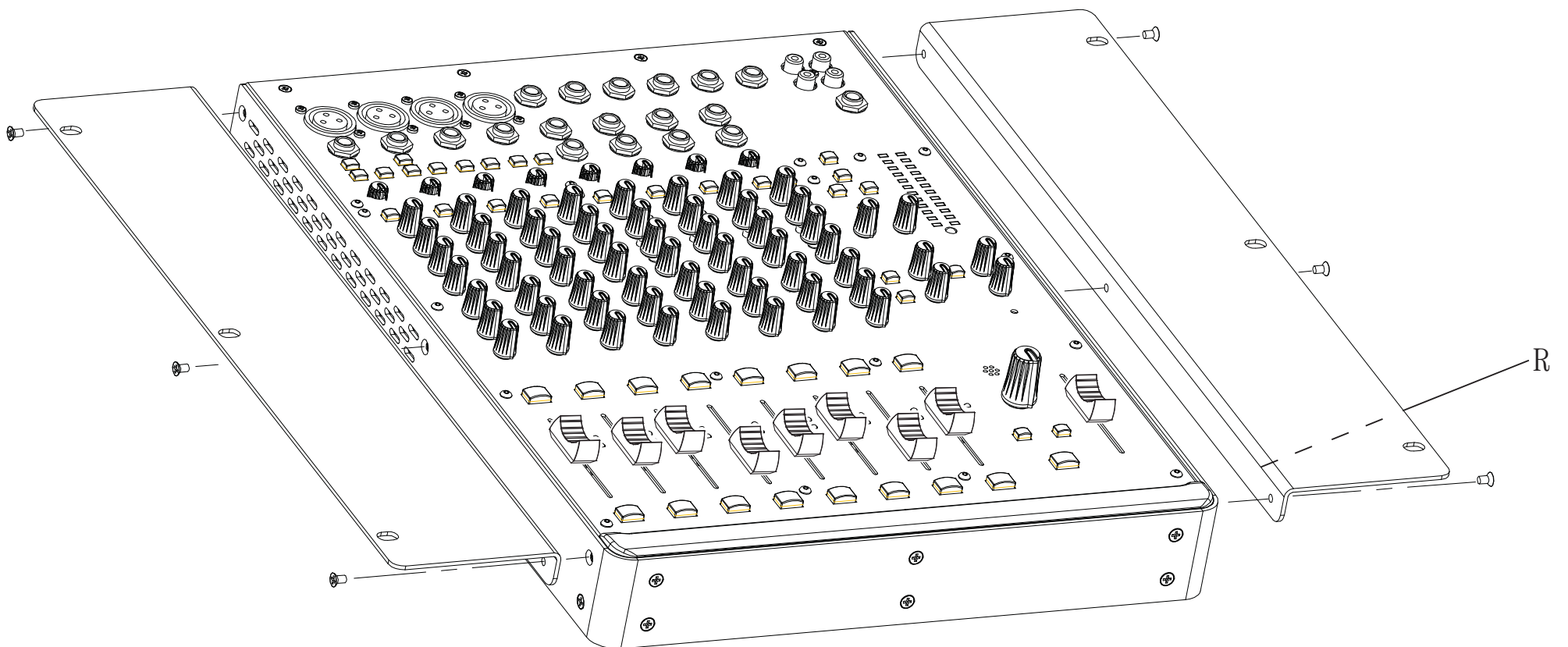

Appendix E: FireWire

The mixer comes with a CD containing the PC driver software needed to use your mixer's internal FireWire interface with Windows XP or Windows Vista.

Mac OS X contains built-in drivers, so no software installation is required.



Before installing the drivers from the CD, please check our website in case there are any updated drivers available. These will come with their own installation instructions which will supercede those shown here.



The CD that contains the PC driver software is the same CD that this owner's manual PDF is on. So if you have not browsed the CD and looked at this owner's manual, you will not be reading this yet. Its a bit of a paradox really, because didn't you just read it? Like this bit of text right now? Hmm..

Mackie Windows FireWire Audio Driver Installation Instructions

System Requirements

Windows XP SP 2 or greater (Home and Pro)

Windows Vista 32 RTM or greater (Home, Business, and Ultimate)

Installation for Windows Vista

1. Connect the FireWire cable from your Onyx 1220i to the computer.
2. Power on your Onyx 1220i, or make sure it is powered on.

3. The Windows application will start its "Found New Hardware" wizard. Select "Locate and install driver software."



4. In the details that follow, ignore any attempt to connect to Windows Update to find the software. You will be prompted to insert the CD that came with your mixer.

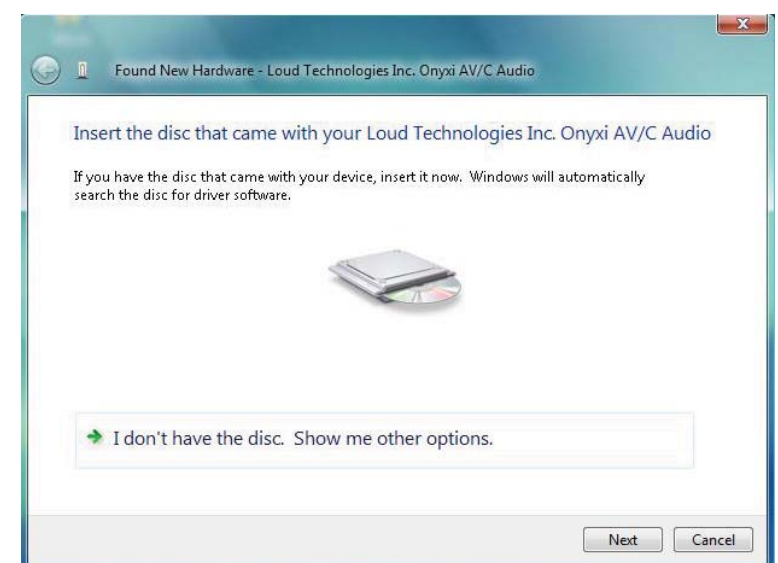

5. Check the box: "Always trust software from LOUD Technologies Inc."



6. Select "Install," and the driver software will be installed.

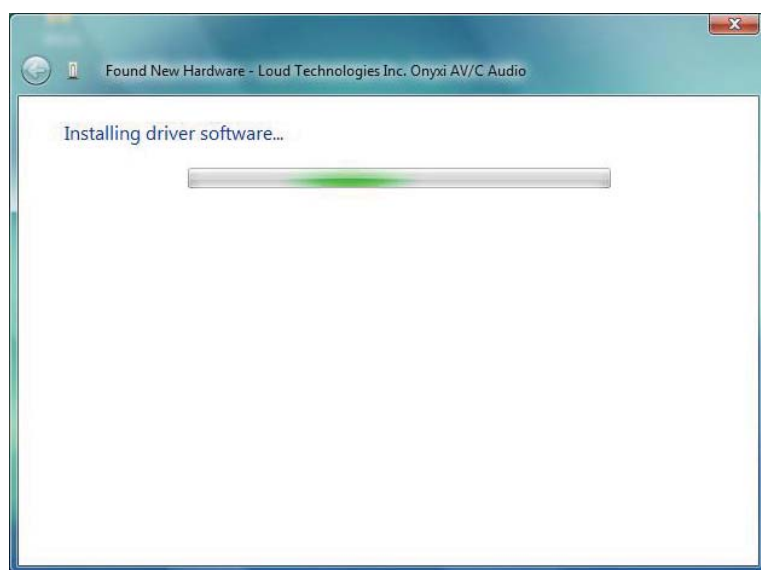

7. The following message confirms that the driver software has been successfully installed.

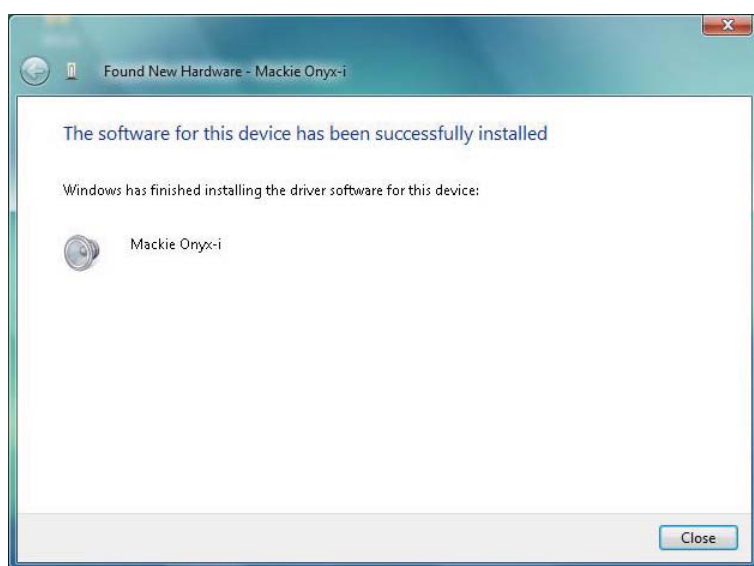

The audio interface is now ready to use with the Digital Audio Workstation software of choice, as well as with consumer audio applications such as iTunes® or Windows Media Player.

Installation for Windows XP

1. Connect the FireWire cable from your Onyx 1220i to the computer.
2. Power on your Onyx 1220i .
3. The Windows XP application will start its "Found New Hardware" wizard.



4. Ignore any attempt to connect to Windows Update to find the software, by checking the "No, not at this time" button. Select "Next."



5. Insert the CD that came with your Onyx 1220i (if you haven't already).
6. Select "Install the software automatically."

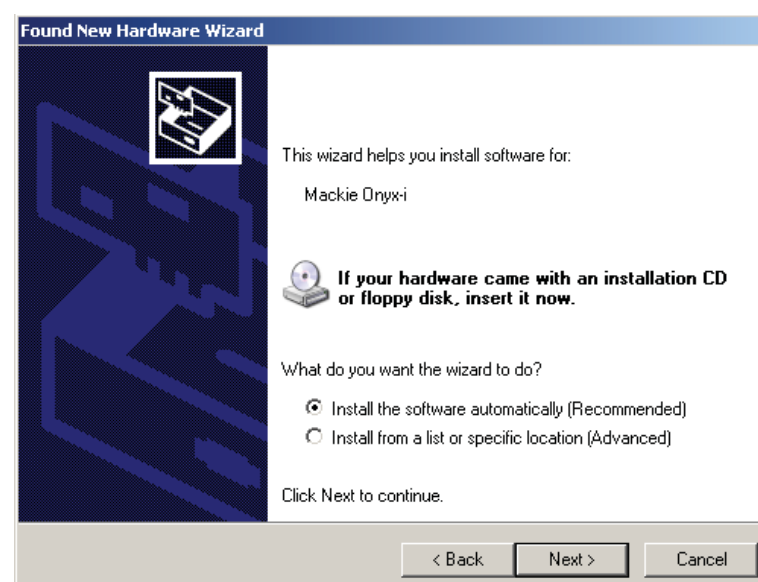

7. Select the “Next” command and the driver software will begin installing.



8. When Windows presents you with a warning about the software not having passed Windows testing, select “Continue Anyway.”

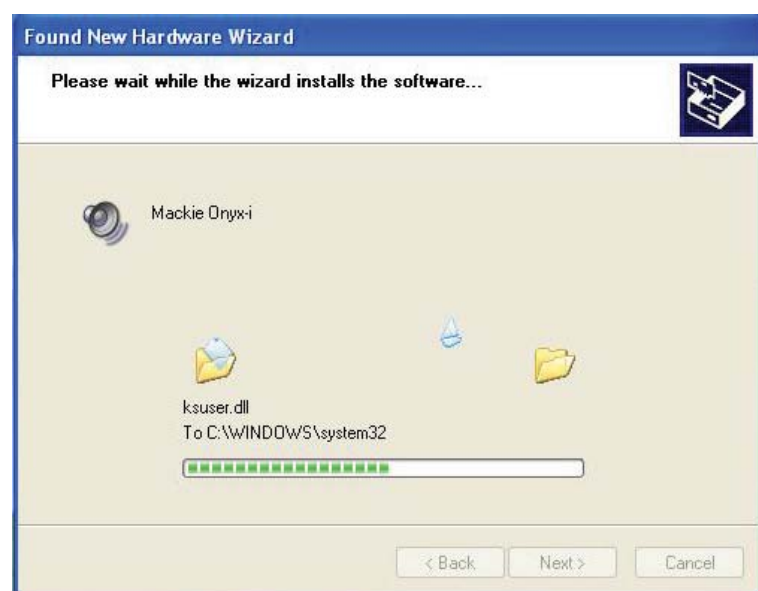

9. Repeat steps 3-8 to allow a second driver to be installed. The found new hardware box will appear all over again, so follow these steps and you are almost done.

10. The following message confirms that the new software has been installed successfully and that the found new hardware wizard is complete.



11. Pack yourself a big lunch and go for a nice walk outside. Have a picnic and lie back and dream. Things are going to be so good now.



The audio interface is now ready to use with the Digital Audio Workstation software of your dreams, as well as with consumer audio applications such as iTunes® or Windows Media Player.

A Note on Available Buffer Sizes

In general, you should always experiment with the available buffer sizes, to find the lowest buffer size that the machine and recording project can comfortably work with.

USING THE ONYX 1220i WITH A MAC

The Onyx 1220i works with Mac OS 10.4.11 and higher. This OS includes the Apple FireWire 2.0 driver. The Onyx 1220i will only work with the 2.0 driver, so if you have an OS before 10.4.11, you will need to check your system for updates from the nice folks at Apple.

1. Connect a FireWire cable from your Onyx 1220i to a FireWire port on your Mac.
2. Turn on your Onyx 1220i.
3. Go to the applications folder, open the utilities folder, and double-click "Audio MIDI Setup."

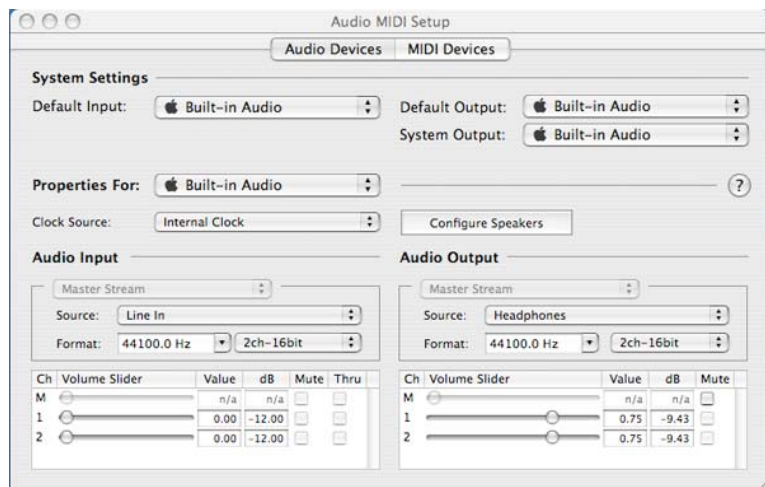

4. Click the Audio Devices tab, and select Onyx i in the "Properties For" drop-down box.

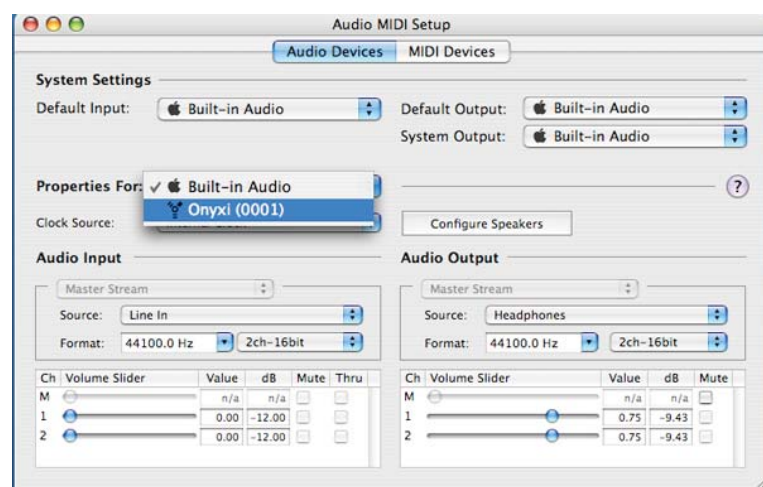

5. Here you can see the settings for the mixer. You can also choose it as your default input or output, as well as designate it to be used for system sound output. There are 12 channels of audio input from the Onyx 1220i, and 2 channels of audio output to the Onyx 1220i.

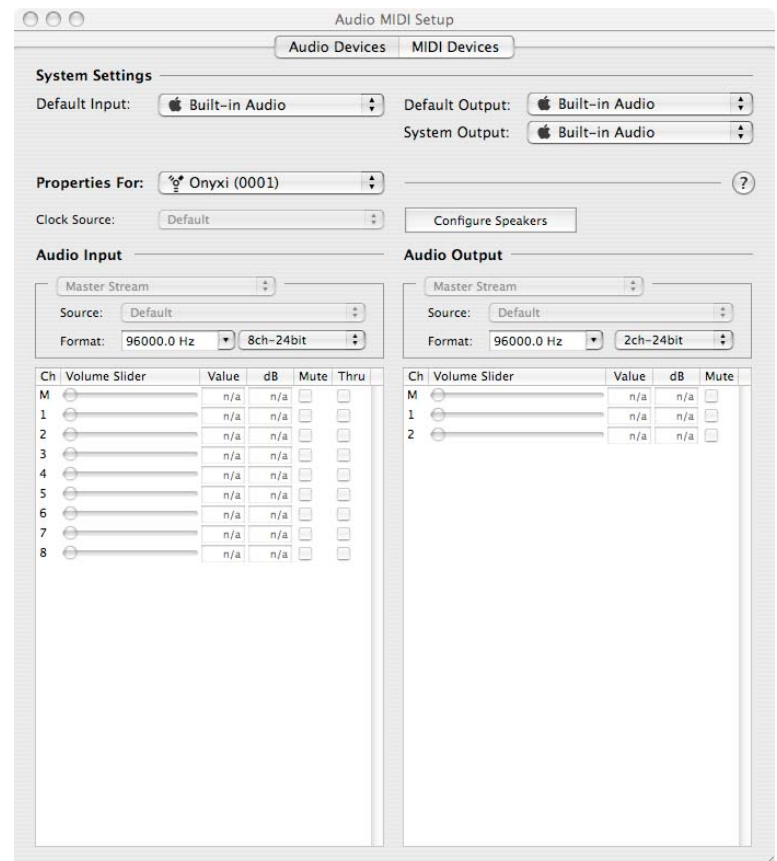

6. The Sample Rate is also shown from 44.1 kHz, 48 kHz, 88.2 kHz and 96 kHz.

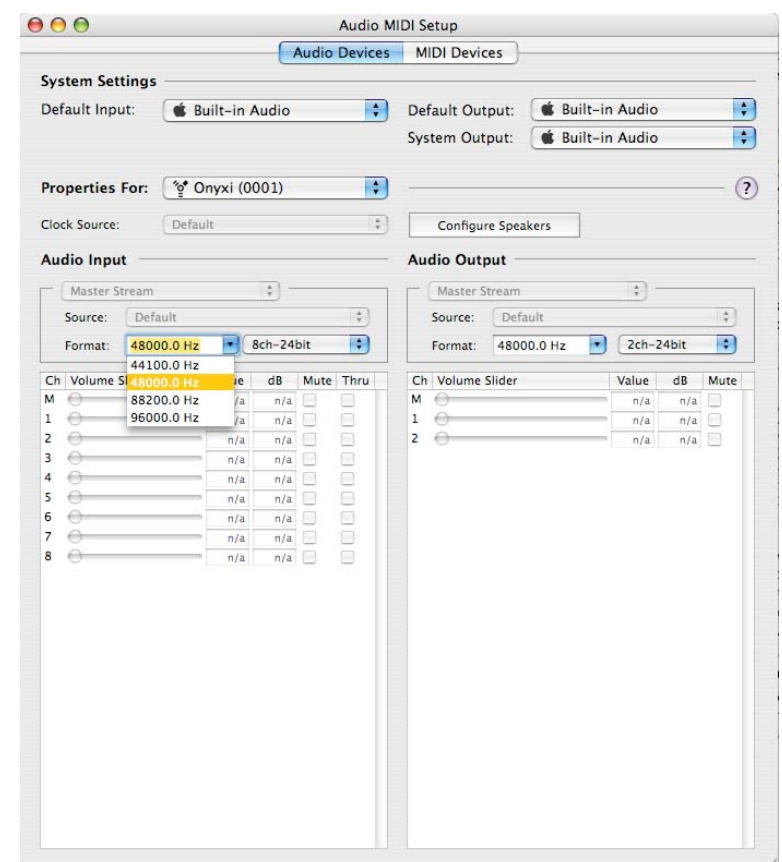

7. You're ready to go with any Mac OS X Core Audio host application (i.e., Traktion, Logic, Cubase, Nuendo, Live, Digital Performer, etc.).
8. In your audio software applications, select and activate the inputs from the mixer and outputs to the mixer.

Appendix F: Modifications

The following modifications can be carried out on the Onyx 1220i by an authorized service center. Authorized service centers may be found online at:

www.mackie.com/scripts/service_centers/search.asp

Please contact our technical support department if you are having trouble finding an authorized service center in your area.

The block diagram on page 32 shows these modifications as dotted lines in the channel signal flow.

Modifications: Post-Insert FireWire Sends

The pre-EQ channel FireWire sends are pre-insert, but the circuit board can be modified so that they are post-insert instead.

For example, this allows for the use of an external processor on the mic signal, sending the result to the FireWire, while still being pre-EQ.

Modifications: Post-Fader FireWire Sends

The post-EQ channel FireWire sends are pre-fader, but the circuit board can be modified so that they are post-fader instead.

This allows the channel level to control the level of the FireWire sends.

Modification: Pre-EQ Aux Sends

The pre-fader aux sends are post-EQ, so they are affected by the channel EQ controls. The circuit board can be modified so the pre-fader aux sends are pre-EQ instead of post-EQ.

For example, your stage monitors will not be affected by any channel EQ adjustments.

Onyx 1220i Track Sheet

MACKIE ONYX 1220i
PREMIUM ANALOG MIXER w/ PERKINS EQ & FIREWIRE

CTRL ROOM/PHONES SOURCE

0dB=0dBu

MAIN MIX

TAPE

FW 1-2

ALT 3-4

ASSIGN TO MAIN MIX

CONTROL ROOM

PHONES

AUX MASTER

SEND

RETURN

PRE POST

RTN TO AUX1

POWER

MUTE

ALT 3/4

dB

10

5

0

-5

-10

-15

-20

-25

-30

-35

-40

-45

-50

-55

-60

-65

-70

-75

-80

OL

U

SOLO

1

2

3

4

5-6

7-8

9-10

11-12

MIC

MAX LEVEL

DESTINATION

PHONES

AUX 1-2

TALKBACK

TALKBACK

MAIN MIX

Onyx 1220i Limited Warranty

Please keep your sales receipt in a safe place.

This Limited Product Warranty ("Product Warranty") is provided by LOUD Technologies Inc. ("LOUD") and is applicable to products purchased in the United States or Canada through a LOUD-authorized reseller or dealer. The Product Warranty will not extend to anyone other than the original purchaser of the product (hereinafter, "Customer," "you" or "your").

For products purchased outside the U.S. or Canada, please visit www.mackie.com/warranty to find contact information for your local distributor, and information on any warranty coverage provided by the distributor in your local market.

LOUD warrants to Customer that the product will be free from defects in materials and workmanship under normal use during the Warranty Period. If the product fails to conform to the warranty then LOUD or its authorized service representative will at its option, either repair or replace any such nonconforming product, provided that Customer gives notice of the noncompliance within the Warranty Period to the Company at: www.mackie.com/support or by calling LOUD technical support at 1.800.898.3211 (toll-free in the U.S. and Canada) during normal business hours Pacific Time, excluding weekends or LOUD holidays. Please retain the original dated sales receipt as evidence of the date of purchase. You will need it to obtain any warranty service.

For full terms and conditions, as well as the specific duration of the Warranty for this product, please visit www.mackie.com/warranty.

The Product Warranty, together with your invoice or receipt, and the terms and conditions located at www.mackie.com/warranty constitutes the entire agreement, and supersedes any and all prior agreements between LOUD and Customer related to the subject matter hereof. No amendment, modification or waiver of any of the provisions of this Product Warranty will be valid unless set forth in a written instrument signed by the party to be bound thereby.

MACKIE®

16220 Wood-Red Road NE • Woodinville, WA 98072 • USA

United States and Canada: 800.898.3211

Europe, Asia, Central and South America: 425.487.4333

Middle East and Africa: 31.20.654.4000

Fax: 425.487.4337 • www.mackie.com

E-mail: sales@mackie.com

Free Manuals Download Website

<http://myh66.com>

<http://usermanuals.us>

<http://www.somanuals.com>

<http://www.4manuals.cc>

<http://www.manual-lib.com>

<http://www.404manual.com>

<http://www.luxmanual.com>

<http://aubethermostatmanual.com>

Golf course search by state

<http://golfingnear.com>

Email search by domain

<http://emailbydomain.com>

Auto manuals search

<http://auto.somanuals.com>

TV manuals search

<http://tv.somanuals.com>