

MACKIE®

ONYX·1220

PREMIUM ANALOG MIXER
w/PERKINS EQ & FIREWIRE OPTION

OWNER'S MANUAL

ONYX
ONYX
ONYX
ONYX
ONYX
ONYX
ONYX
ONYX
ONYX

Important Safety Instructions

1. Read these instructions.
2. Keep these instructions.
3. Heed all warnings.
4. Follow all instructions.
5. Do not use this apparatus near water.
6. Clean only with dry cloth.
7. Do not block any ventilation openings. Install in accordance with the manufacturer's instructions.
8. Do not install near any heat sources such as radiators, heat registers, stoves, or other apparatus (including amplifiers) that produce heat.
9. Do not defeat the safety purpose of the polarized or grounding-type plug. A polarized plug has two blades with one wider than the other. A grounding-type plug has two blades and a third grounding prong. The wide blade or the third prong are provided for your safety. If the provided plug does not fit into your outlet, consult an electrician for replacement of the obsolete outlet.
10. Protect the power cord from being walked on or pinched particularly at plugs, convenience receptacles, and the point where they exit from the apparatus.
11. Only use attachments/accessories specified by the manufacturer.
12. Use only with a cart, stand, tripod, bracket, or table specified by the manufacturer, or sold with the apparatus. When a cart is used, use caution when moving the cart/apparatus combination to avoid injury from tip-over.
13. Unplug this apparatus during lightning storms or when unused for long periods of time.
14. Refer all servicing to qualified service personnel. Servicing is required when the apparatus has been damaged in any way, such as power-supply cord or plug is damaged, liquid has been spilled or objects have fallen into the apparatus, the apparatus has been exposed to rain or moisture, does not operate normally, or has been dropped.
15. This Onyx mixer has been designed with Class-I construction and must be connected to a mains socket outlet with a protective earthing connection (the third grounding prong).
16. This Onyx mixer has been equipped with an all-pole, rocker-style AC mains power switch. This switch is located on the rear panel and should remain readily accessible to the user.
17. This apparatus does not exceed the Class A/Class B (whichever is applicable) limits for radio noise emissions from digital apparatus as set out in the radio interference regulations of the Canadian Department of Communications.

ATTENTION — *Le présent appareil numérique n'émet pas de bruits radioélectriques dépassant les limites applicables aux appareils numériques de class A/de class B (selon le cas) prescrites dans le règlement sur le brouillage radioélectrique édicté par les ministere des communications du Canada.*

18. Exposure to extremely high noise levels may cause permanent hearing loss. Individuals vary considerably in susceptibility to noise-induced hearing loss, but nearly everyone will lose some hearing if exposed to sufficiently intense noise for a period of time. The U.S. Government's Occupational Safety and Health Administration (OSHA) has specified the permissible noise level exposures shown in the following chart.

According to OSHA, any exposure in excess of these permissible limits could result in some hearing loss. To ensure against potentially dangerous exposure to high sound pressure levels, it is recommended that all persons exposed to equipment capable of producing high sound pressure levels use hearing protectors while the equipment is in operation. Ear plugs or protectors in the ear canals or over the ears must be worn when operating the equipment in order to prevent permanent hearing loss if exposure is in excess of the limits set forth here.

Duration Per Day In Hours	Sound Level dBA, Slow Response	Typical Example
8	90	Duo in small club
6	92	
4	95	Subway Train
3	97	
2	100	Very loud classical music
1.5	102	
1	105	Tami screaming at Adrian about deadlines
0.5	110	
0.25 or less	115	Loudest parts at a rock concert

PORTABLE CART WARNING



Carts and stands - The Component should be used only with a cart or stand that is recommended by the manufacturer. A Component and cart combination should be moved with care. Quick stops, excessive force, and uneven surfaces may cause the Component and cart combination to overturn.

CAUTION AVIS

RISK OF ELECTRIC SHOCK
DO NOT OPEN

RISQUE DE CHOC ELECTRIQUE
NE PAS OUVRIR

CAUTION: TO REDUCE THE RISK OF ELECTRIC SHOCK
DO NOT REMOVE COVER (OR BACK)
NO USER-SERVICEABLE PARTS INSIDE
REFER SERVICING TO QUALIFIED PERSONNEL

ATTENTION: POUR EVITER LES RISQUES DE CHOC ELECTRIQUE, NE PAS ENLEVER LE COUVERCLE. AUCUN ENTRETIEN DE PIECES INTERIEURES PAR L'USAGER. CONFIER L'ENTRETIEN AU PERSONNEL QUALIFIE.

AVIS: POUR EVITER LES RISQUES D'INCENDIE OU D'ELECTROCUTION, N'EXPOSEZ PAS CET ARTICLE A LA PLUIE OU A L'HUMIDITE

The lightning flash with arrowhead symbol within an equilateral triangle is intended to alert the user to the presence of uninsulated "dangerous voltage" within the product's enclosure, that may be of sufficient magnitude to constitute a risk of electric shock to persons.

Le symbole clair avec point de flèche l'intérieur d'un triangle équilatéral est utilisé pour alerter l'utilisateur de la présence d'un risque de choc électrique.

The exclamation point within an equilateral triangle is intended to alert the user of the presence of important operating and maintenance (servicing) instructions in the literature accompanying the appliance.

Le point d'exclamation l'intérieur d'un triangle équilatéral est employé pour alerter les utilisateurs de la présence d'instructions importantes pour le fonctionnement et l'entretien (service) dans le livret d'instruction accompagnant l'appareil.

WARNING — To reduce the risk of fire or electric shock, do not expose this apparatus to rain or moisture.

Table of Contents

Introduction	4
Getting Started	5
Zero the Controls	5
Connections	5
Set the Levels	5
Instant Mixing	5
Hookup Diagrams	6
Onyx 1220 Features	10
Channel Strips	10
Control Room Matrix, Metering, and Phones.....	14
Auxiliary Section	15
TALKBACK Section	16
Front Panel Connectors	18
Rear Panel.....	19
Appendix A: Service Information	21
Warranty Service.....	21
Troubleshooting	21
Repair	22
Appendix B: Connections	23
Appendix C: Technical Info	26
Onyx 1220 Specifications	26
Onyx 1220 Block Diagram	28
Onyx 1220 Track Sheet.....	29
Onyx 1220 Limited Warranty	31

Don't forget to visit our website at www.mackie.com for more information about this and other Mackie products.



Introduction

Thank you for choosing a Mackie Onyx 1220 professional compact mixing console. The Onyx Series of mixers are designed for the digital era and offer the newest features and latest technologies for live sound reinforcement and analog or digital studio recording in a durable, road-worthy package.

The Onyx 1220 is equipped with four of our new premium precision-engineered studio-grade Onyx mic preamps. Mackie is renowned for the high-quality mic preamps used in our mixers, and the Onyx mic pre's are better than ever, with specifications rivaling expensive stand-alone mic preamplifiers.

Channels 1 and 2 feature high-impedance instrument/line-level inputs so you can connect an acoustic, electric, or bass guitar directly into the mixer, eliminating the need for an external direct box.

Each of the four mono channels have individual phantom power switches, low-cut filters, pre-EQ channel inserts, and an all new three-band EQ design with sweepable mids and EQ bypass switch.

Channels 5 through 12 are four stereo pairs of line inputs, featuring a three-band EQ and EQ bypass switch for each stereo pair.

All mono channels and stereo pairs have two Aux sends, Pan, Mute/Alt 3-4, Solo, 60 mm Fader, and four signal level indicators.

A built-in Talkback mic with routing switches allows you to communicate through the Aux Sends or Phones outputs.

All twelve channels have balanced direct outputs on two DB-25 connectors for multitrack recording. An optional FireWire card provides all twelve direct outputs and the L-R Main Mix on a FireWire interface for streaming digital audio to a laptop for multitrack recording in a live situation, or connecting to a DAW in a home studio.

Please write your serial number here for future reference (i.e., insurance claims, tech support, return authorization, etc.)

Purchased at:

Date of purchase:

HOW TO USE THIS MANUAL

We know that many of you can't wait to get your new mixer hooked up, and you're probably not going to read the manual first (sigh!). So the first section after the table of contents is a Quick-Start Guide to help you get the mixer set up fast so you can start using it right away. Right after that are the ever popular hook-up diagrams that show typical mixer setups for live sound, recording and mixdown.

Then, when you have time, read the Features Description section. This describes every knob, button, and connection point on the Onyx 1220, roughly following the signal flow through the mixer from top to bottom and left to right.

Throughout this section you'll find illustrations with each feature numbered. If you want to know more about a feature, simply locate it on the appropriate illustration, notice the number attached to it, and find that number in the nearby paragraphs.



This icon marks information that is critically important or unique to the Onyx 1220. For your own good, read them and remember them. They will be on the final test.



This icon leads you to in-depth explanations of features and practical tips. While not mandatory, they usually have some valuable nugget of information.

A PLUG FOR THE CONNECTOR SECTION

Appendix B is a section on connectors: XLR connectors, balanced connectors, unbalanced connectors, and special hybrid connectors.

More resources on our website at www.mackie.com.

THE GLOSSARY: A Haven of Non-Techiness for the Neophyte

The "Glossary of Terms" is a fairly comprehensive dictionary of pro-audio terms. If terms like "clipping," "noise floor," or "unbalanced" leave you blank, refer to this glossary for a quick explanation.

ARCANE MYSTERIES ILLUMINATED

"Arcane Mysteries" discusses some of the down 'n' dirty practical realities of microphones, fixed installations, grounding, and balanced versus unbalanced lines. It's a goldmine for the neophyte, and even the seasoned pro might learn a thing or two.

Getting Started

READ THIS PAGE!!

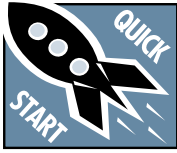

Even if you're one of those people who never read manuals, all we ask is that you read this page now before you begin using the Onyx 1220. You'll be glad you did!

Zero the Controls

1. Turn down the channel GAIN, AUX, and Fader controls, and center the channel EQ and PAN controls.
2. Set all push button switches to their "out" positions.
3. In the output section (right hand side), turn all the rotary knobs "down," the switches "out," and the MAIN MIX fader down.
4. Turn the POWER switch off.

Connections

If you already know how you want to connect the Onyx 1220, go ahead and connect the inputs and outputs the way you want them. If you just want to get sound through the mixer, follow these steps:

1. Plug a microphone or other signal source into channel 1's MIC or LINE input.
2. Plug in the detachable linecord, connect it to an AC outlet, and turn on the Onyx 1220's POWER switch.
3. Connect cords from the Onyx 1220's MAIN OUTS (XLR connectors on the rear panel and 1/4" TRS connectors on the front panel) to your amplifier.
4. Hook up speakers to the amp and turn it on. If the amplifier has level controls, set them however the manufacturer recommends (usually all the way up).

Set the Levels

To set the channel GAIN controls, it's not even necessary to hear what you're doing at the outputs of the mixer. If you want to listen while you work, plug headphones into the PHONES jack on the front panel, then set the PHONES knob about one-quarter of the way up.

The following steps must be performed one channel at a time.

1. Push in the channel's SOLO switch.
2. Play something into the selected input. This could be an instrument, a singing or speaking voice, or

a line input such as a CD player or tape recorder output. Be sure that the volume of the input source is the same as it would be during normal use. If it isn't, you might have to readjust these levels during the middle of the set.

3. Adjust the channel's GAIN control so that the LEDs on the RIGHT meter stay around "0" and never go higher than "+7."
4. If you'd like to apply some EQ, do so now and return to step 3. Remember to push in the EQ IN/OUT button or the EQ controls won't do anything.
5. Disengage that channel's SOLO switch.
6. Repeat for each channel.

Instant Mixing

1. Leave the microphone plugged into channel 1 and connect a keyboard, guitar or other instrument to channel 2. Be sure to "Set the Level" for channel 2 as described above.
2. To get sound out of the speakers, turn up channel 1 and 2 faders to the "U" mark and slowly turn up the MAIN MIX fader to a comfortable listening level.
3. Sing and play. You're a star! Adjust the faders for channels 1 and 2 to bring your voice and your instrument up and down to create your own mix.

Other Nuggets of Wisdom

- For optimum sonic performance, the channel and MAIN MIX faders should be set near the "U" (unity gain) markings.
- Always turn the MAIN MIX fader and CONTROL ROOM knob down before making connections to and from your Onyx 1220.
- When you shut down your equipment, turn off the amplifiers first. When powering up, turn on the amplifiers last.
- Never listen to loud music for prolonged periods. Please see the Safety Instructions on page 2 for information on hearing protection.
- Save the shipping box! You may need it someday, and you don't want to have to pay for another one.

That's it for the "Getting Started" section. Next comes the "Hookup" section that shows you some typical ways that you might use the Onyx 1220 in real applications. After that, you can take the grand tour of the mixer, with descriptions of every knob, button, input, and output. We encourage you to take the time to read all of the feature descriptions, but at least you know it's there if you have any questions.

Hookup Diagrams

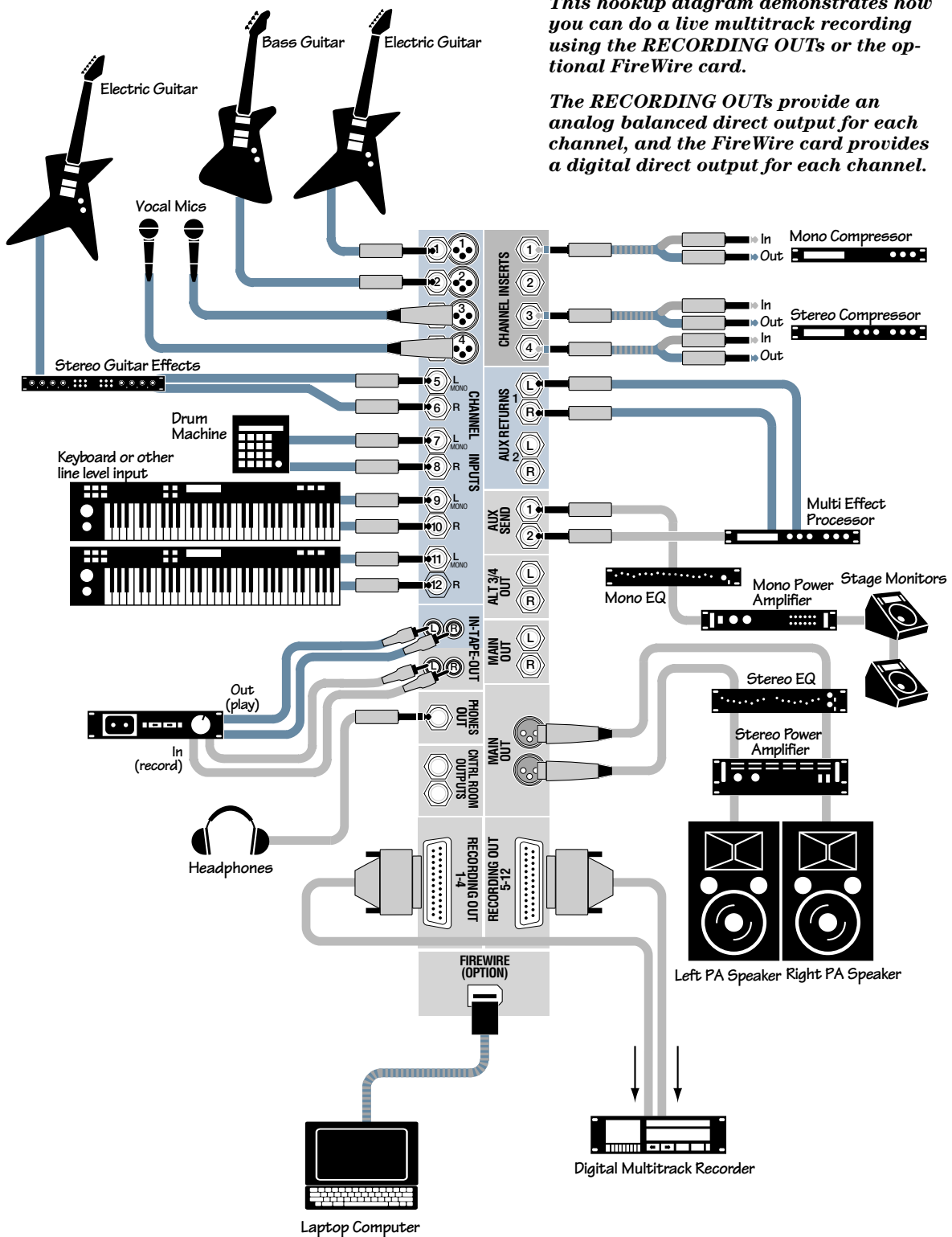

This hookup diagram demonstrates how you can do a live multitrack recording using the RECORDING OUTs or the optional FireWire card.

The RECORDING OUTs provide an analog balanced direct output for each channel, and the FireWire card provides a digital direct output for each channel.

Onyx 1220 Live Mix and Multitrack Recording

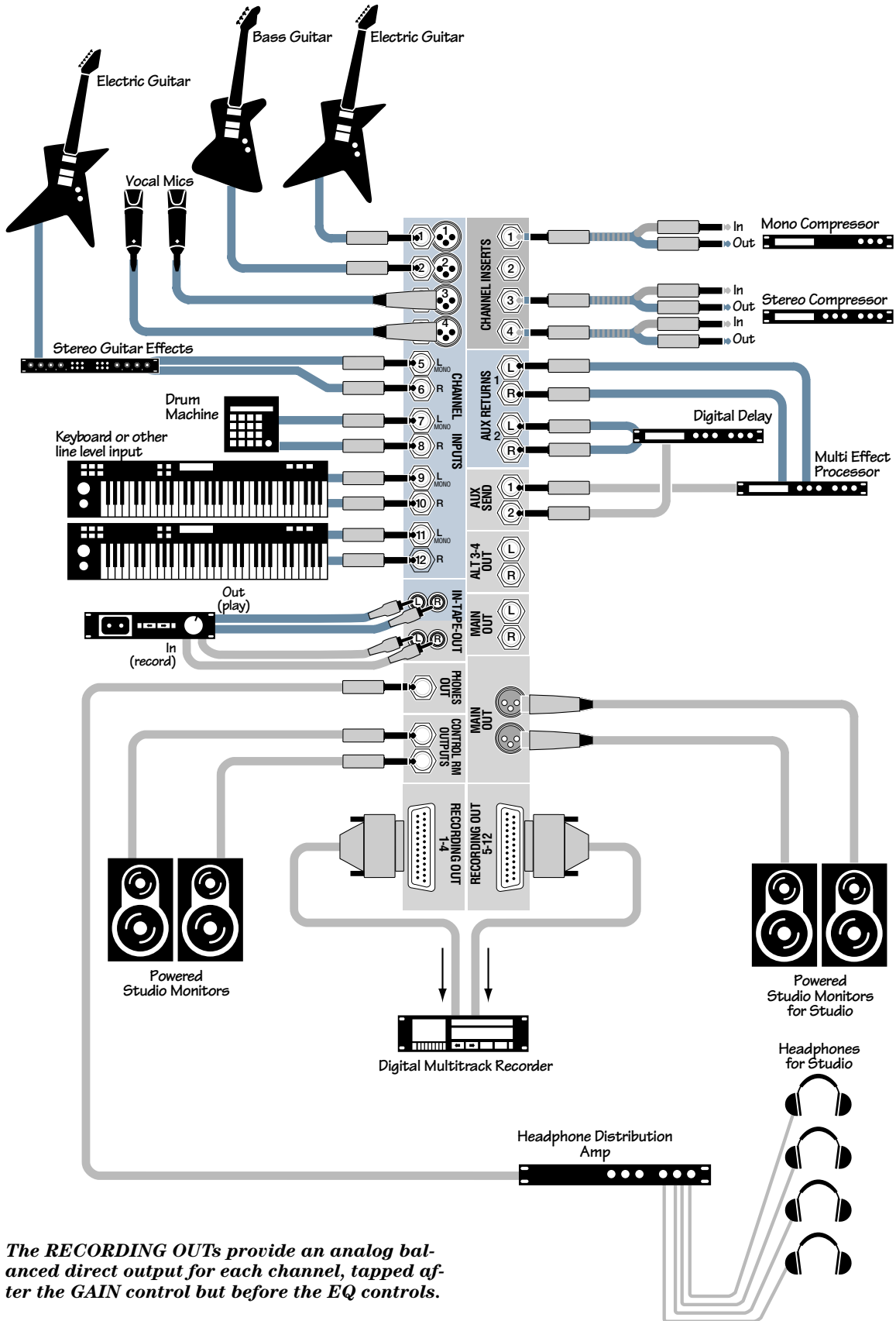

The RECORDING OUTs provide an analog balanced direct output for each channel, tapped after the GAIN control but before the EQ controls.

Onyx 1220 Multitrack Recording in a Studio (Tracking)

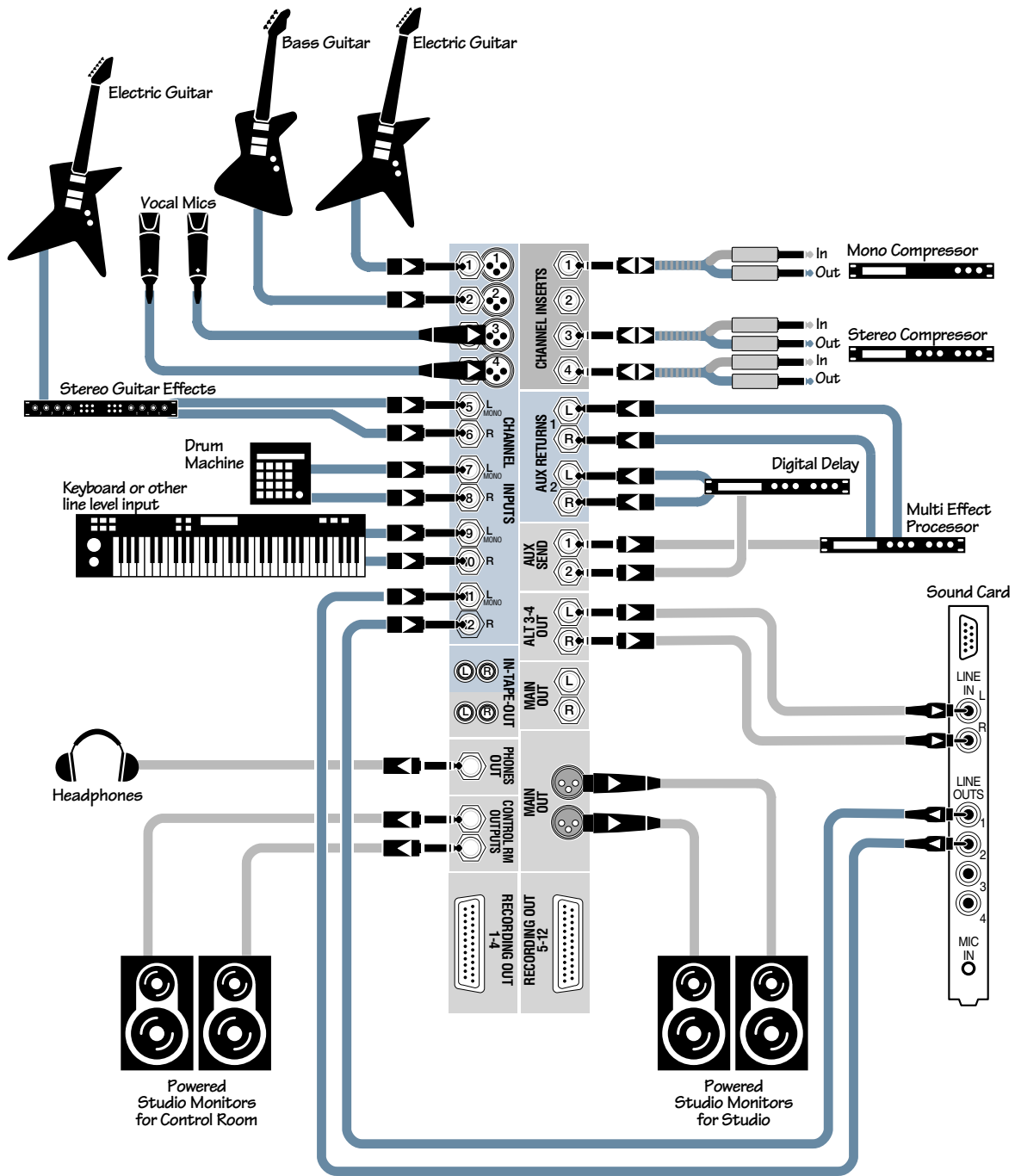

In this hookup diagram, the tracking channels have the MUTE/ALT 3-4 button pushed in. This routes their signals to the ALT 3-4 OUT and on to the Sound Card or other analog audio interface to your DAW.

IMPORTANT: *The playback channels (channels 11-12 in this case) should have their MUTE/ALT 3-4 buttons out or you will get feedback. Ouch!*

Onyx 1220 Computer Recording

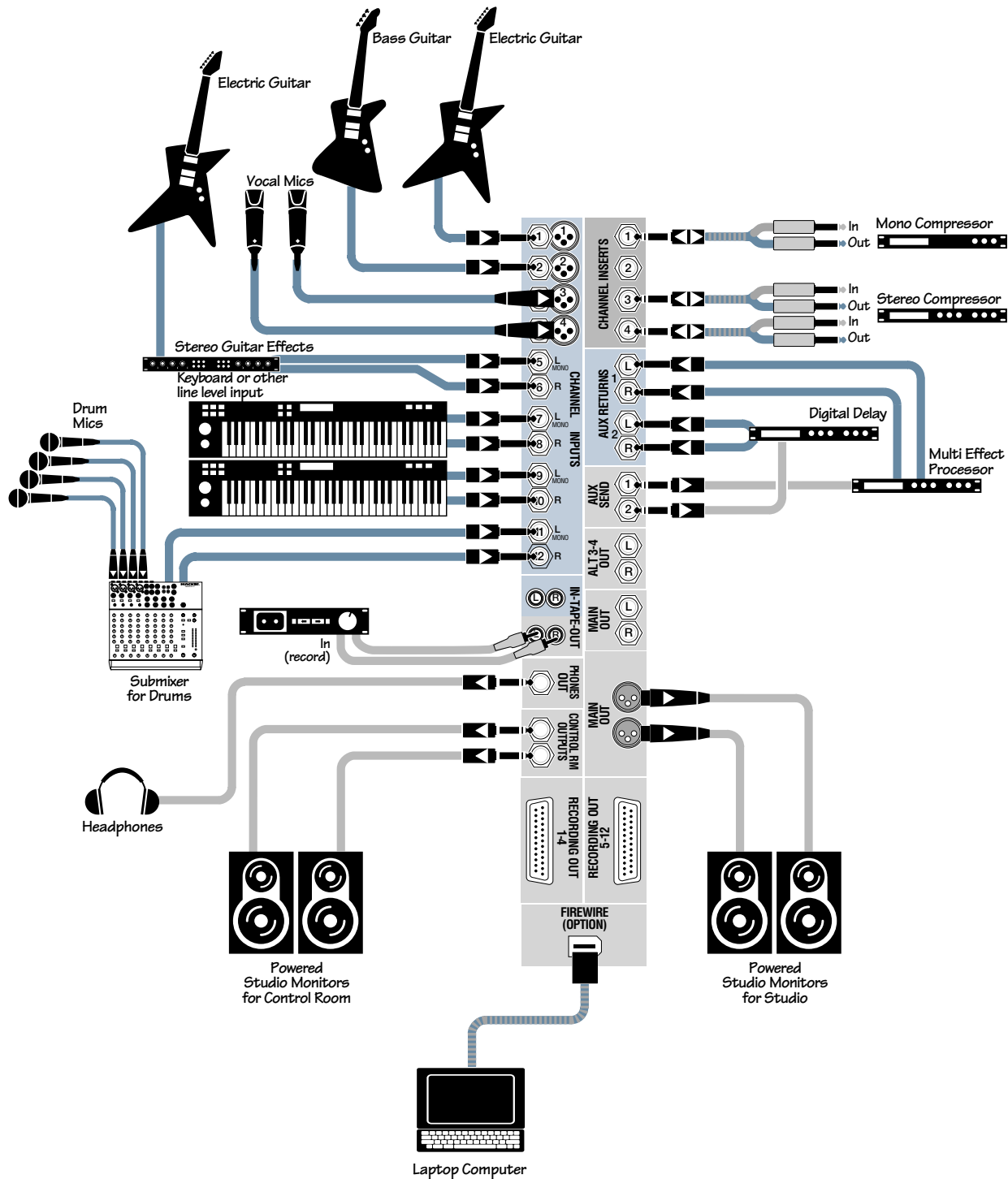

The optional FireWire card provides a digital direct output for each channel, tapped after the GAIN control but before the EQ controls, as well as the L-R Mix. Two tracks can be returned to the Onyx from the computer for playback monitoring in the Control Room Outputs, or mixdown to two tracks at the TAPE OUT.

Onyx 1220 Recording with FireWire to a Laptop

Onyx 1220 Features

Channel Strips

There are two kinds of channel strips on the Onyx 1220: Mono and Stereo. The mono channel strips (channels 1-4) have mic and line input connectors. In addition, channels 1 and 2 have high-impedance instrument inputs so you can connect a guitar directly to the mixer.

The stereo channel strips (channels 5-12), have two line input connectors per channel strip, left and right. The stereo path is maintained throughout the channel strip, sharing the channel's controls (the controls work on both left and right signals at the same time).

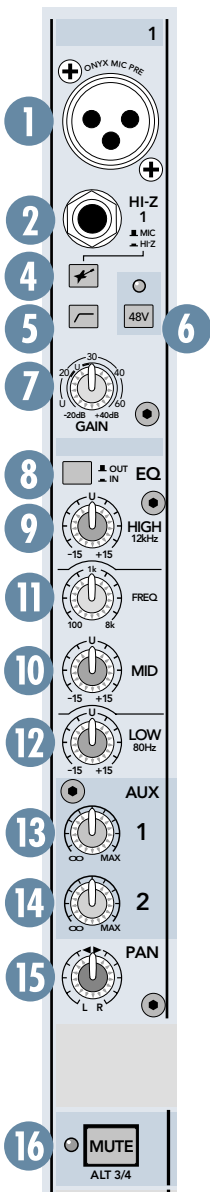

Mono Channel

1. MIC Input (Channels 1-4)

This is a female XLR connector, which accepts a balanced microphone input from almost any type of microphone. The microphone preamps feature our new Onyx design, with higher fidelity and headroom rivaling any standalone mic preamp on the market today.

The XLR inputs are wired as follows:
 Pin 1 = Shield or ground
 Pin 2 = Positive (+ or hot)
 Pin 3 = Negative (- or cold)

2. HI-Z Instrument Input (Channels 1-2)

This is a 1/4" connector, which accepts an unbalanced instrument-level input signal from a high-impedance instrument like a guitar.

3. LINE Input (Channels 3-12)

This is a 1/4" TRS connector, which accepts a balanced or unbalanced line-level input signal from almost any source.

When connecting a balanced signal to the LINE inputs, wire them as follows:

Tip = Positive (+ or hot)
 Ring = Negative (- or cold)
 Sleeve = Shield or ground

When connecting an unbalanced signal, wire them as follows:

Tip = Positive (+ or hot)
 Sleeve = Shield or ground

Note: For the stereo channels 5-12, if a signal is plugged into the LEFT (MONO) side and nothing is plugged into the RIGHT side, the signal is automatically connected to both LEFT and RIGHT sides. This is called jack normalling. As soon as something is plugged into the RIGHT side, the normalled connection is broken and the LEFT and RIGHT inputs become stereo inputs (LEFT goes to the LEFT MAIN OUT and RIGHT goes to the RIGHT MAIN OUT).

4. MIC/HI-Z Switch

Channels 1 and 2 have an extra button for switching between the MIC and HI-Z inputs. When the button is out (MIC), the XLR MIC input is used and the HI-Z input is disconnected. When the button is pushed in (HI-Z), the 1/4" HI-Z input is used and the XLR MIC input is disconnected. The input stage of the HI-Z inputs is specially designed for the high-impedance pickups on guitars.



Plugging a guitar into a lower-impedance line input (like those on channels 3-16) can result in the loss of high frequencies, causing an unnatural and dull sound. Normally, you must use a direct box between a guitar and a mixer's input, which serves to convert the impedance of the guitar from high to low. The HI-Z inputs on channels 1 and 2 make the need for a direct box unnecessary.

HOWEVER: The HI-Z inputs are unbalanced, so if you're doing a live show and running a long cord between the instrument and the mixer (say over 25 or 30 feet), it is best to use a direct box with a balanced output to avoid picking up noise over the length of the cord.

5. Low-Cut Switch (Channels 1-4)

The Low-Cut switch, often referred to as a high-pass filter, cuts bass frequencies below 75 Hz at a rate of 18 dB per octave.

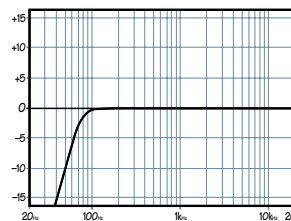

Low Cut

We recommend that you use the Low-Cut filter on every microphone application except kick drum, bass guitar, bassy synth patches, or recordings of earthquakes.

These aside, there isn't much down there that you want to hear, and filtering it out makes the low stuff you do want much more crisp and tasty. Not only that, but the Low-Cut filter can help reduce the possibility of feedback in live situations and it helps to conserve the amplifier power.



Another way to use the Low Cut filter is in combination with the LOW EQ on vocals during live performances. Many times, bass shelving EQ can really benefit voices. Trouble is, adding LOW EQ also boosts stage rumble, mic handling clunks, and breath pops. Low Cut removes all those problems so you can add LOW EQ without losing a woofer.

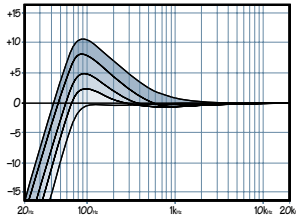

Low Cut with Low EQ Boosted

Here's what the combination of LOW EQ and Low Cut looks like in terms of frequency curves.

6. 48V Phantom Power Switch (Channels 1-4)

Most professional condenser microphones require phantom power, which is a low-current DC voltage delivered to the microphone on pins 2 and 3 of the XLR microphone connector. Push in the 48V button if your microphone needs phantom power. An LED lights just above the button to indicate that phantom power is active on that channel.

Dynamic microphones, like Shure's SM57 and SM58, do not require phantom power. However, phantom power will not harm most dynamic microphones should you accidentally plug one in while the phantom power is turned on. Be careful with older ribbon microphones. Check the manual for your microphone to find out for sure whether or not phantom power can damage it.

Note: Be sure the MAIN MIX fader (36) is turned down when connecting microphones to the MIC Inputs, especially when phantom power is turned on, to prevent pops from getting through to the speakers.

7. GAIN Control

If you haven't already, please read "Set the Levels" on page 5.

The GAIN control adjusts the input sensitivity of the mic and line inputs. This allows the signal from the outside world to be adjusted to optimal internal operating levels.

If the signal is plugged into the XLR jack, there is 0 dB of gain (unity gain) with the knob turned all the way down, ramping up to 60 dB of gain fully up.

When connected to the 1/4" jack, there is 20 dB of attenuation all the way down, and 40 dB of gain fully up, with a "U" (unity gain) mark at about 10:00. (On the stereo channels, the GAIN range is -20 dB to +20 dB with unity in the center.)

8. EQ IN/OUT Switch

This is a true hardware bypass of the Perkins EQ circuitry to insure that there is no coloration of the signal if the EQ is not needed. When this button is out, the EQ controls have no effect on the signal. You can use this switch to make an A/B comparison between the EQ'd signal and the signal without EQ.



We have completely redesigned the EQ circuits in the Onyx Series of mixers, based on the designs of Cal Perkins, an industry-leader in audio engineering for over three decades and long-time Mackie collaborator. This "neo-classic" design provides the sweet musicality of the British EQ sound, while still maintaining 15 dB of boost and cut with optimum Q and minimum phase shift (in other words, it gives you plenty of control and is pleasing to the ear!).

The 3-band equalization has LOW shelving at 80 Hz, MID peaking (sweepable from 100 Hz to 8 kHz on the mono channels, fixed at 2.5 kHz on the stereo channels), and HIGH shelving at 12 kHz. "Shelving" means that the circuitry boosts or cuts all frequencies past the specified frequency. For example, rotating the LOW EQ knob 15 dB to the right boosts bass frequencies starting at 80 Hz and continuing on down to the lowest note you ever heard. "Peaking" means that the frequencies around the center frequency are less affected by the EQ the further away they are.

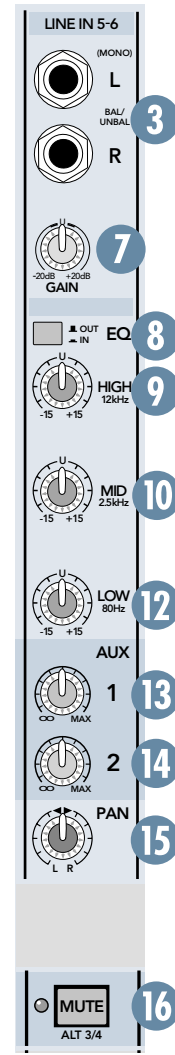

Stereo Channel

9. HIGH EQ

This control gives you up to 15 dB boost or cut at 12 kHz, and it is also flat at the center detent. Use it to add sizzle to cymbals, and an overall sense of transparency or edge to the keyboards, vocals, guitar, and bacon frying. Turn it down a little to reduce sibilance, or to hide tape hiss.

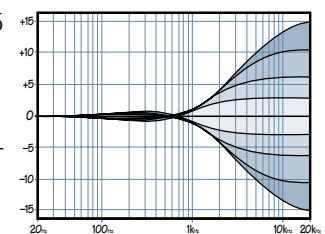

High EQ

10. MID EQ

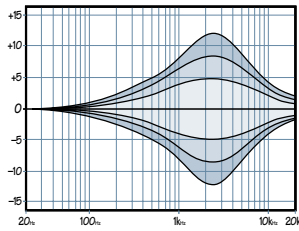

Mid EQ

Short for “midrange,” this knob provides 15 dB of boost or cut centered at the frequency determined by the **FREQ** knob (see **FREQ** next), or at 2.5 kHz for the stereo channels. Midrange EQ is often thought of as the most dynamic because

the frequencies that define any particular sound are almost always found in this range. You can create many interesting and useful EQ changes by turning this knob down as well as up.

11. FREQ

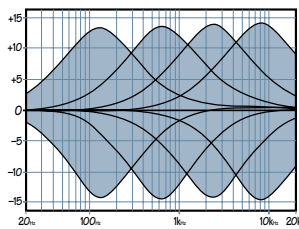

Mid EQ Freq Sweep

This knob ranges from 100 Hz to 8 kHz and determines the center frequency for the MID EQ. This allows you to zero in on the precise narrow band of frequencies you want to have affected by the MID EQ.

12. LOW EQ

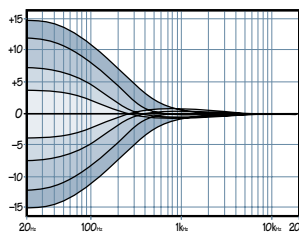

Low EQ

This control gives you up to 15 dB of boost or cut at 80 Hz. The circuit is flat (no boost or cut) at the center detent position. This frequency represents the punch in bass drums, bass guitar, fat synth patches, and some really serious male singers.

Note: Used in conjunction with the Low Cut switch, you can boost the LOW EQ without injecting tons of infrasonic debris into the mix.

13. and 14. AUX 1 and 2 Sends

These tap a portion of each channel’s signal out to either an effects processor or for stage monitoring. The AUX Send levels are controlled by the channel’s AUX 1 and AUX 2 knobs, and by the AUX MASTER 1 and 2 knobs (26).

Since the AUX Sends are mono, the left and right signals in the stereo channels are summed together prior

to the AUX 1 and AUX 2 controls, sending the combined signal to the AUX SEND outputs.

These are more than just effects and monitor sends. They can be used to generate separate mixes for recording, for another zone, or “mix-minuses” for broadcast.

15. PAN

PAN adjusts the amount of channel signal sent to the left versus the right outputs. On the stereo channels (channels 5-12), the PAN knob works like the balance control on your home stereo (panning left turns down the right channel, and panning right turns down the left channel).

With the PAN knob hard left, the signal feeds either the MAIN LEFT (bus 1) or ALT LEFT (bus 3), depending on the setting of the ALT 3/4 switch. With the knob hard right, the signal feeds either the MAIN RIGHT (bus 2) or ALT RIGHT (bus 4).



Constant Loudness: The Onyx 1220’s PAN control employs a design called “Constant Loudness.” If you have a channel panned hard left (or right) and then pan to the center, the signal is attenuated about 3 dB to maintain

the same apparent loudness. Otherwise, it would make the sound appear much louder when panned center.

16. MUTE/ALT 3-4

The dual-purpose MUTE/ALT 3-4 switch is a Mackie signature. When Greg was designing our first product, he had to include a mute switch for each channel. Mute switches do just what they sound like they do. They turn off the signal by “routing” it into oblivion. *“Gee, what a waste,”* Greg reasoned. *“Why not have the mute button route the signal somewhere else useful, like a separate stereo bus?”* So MUTE/ALT 3-4 really serves two functions—muting (often used during mixdown or live shows), and signal routing (for multitrack and live work) where it acts as an extra stereo bus.

To use this as a MUTE switch, all you have to do is **not** use the ALT 3-4 outputs (49). Then, whenever you assign a channel to these unused outputs, you’ll also be disconnecting it from the MAIN MIX, effectively muting the channel. The MUTE switch also disconnects the channel from the POST AUX SEND bus. The channel’s signal is still present on the PRE AUX SEND bus.

To use this as an ALT 3-4 switch, all you have to do is connect the ALT 3-4 outputs (49) to whatever destination you desire. Two popular examples:

When doing multitrack recording, you can use the ALT 3-4 outputs as a stereo or dual-mono feed to your multitrack.

When doing live sound or mixdown, it's often handy to control the level of several channels with one knob. That's called subgrouping. Simply assign these channels to the ALT 3-4 mix, engage ALT 3-4 in the CONTROL ROOM/PHONES SOURCE matrix (20), and the signals will appear at the CONTROL ROOM (48) and PHONES (42) outputs. If you want the ALT 3-4 signals to go back into the MAIN MIX, engage the ASSIGN TO MAIN MIX switch (21) and the CONTROL ROOM knob (22) controls the levels of all the channels assigned to ALT 3-4.

Another way to do the same thing is to assign the channels to the ALT 3-4 mix, then patch out of the ALT 3-4 OUT (LEFT/3 and RIGHT/4) back into an unused stereo channel (5-6, 7-8, 9-10, or 11-12). If that's your choice, don't ever engage the MUTE/ALT 3-4 switch on that stereo channel, or you'll have every dog in the neighborhood howling at your feedback loop.

Another benefit of the ALT 3-4 feature is that it can act as an "AFL" (After Fader Listen). Just engage a channel's MUTE/ALT 3-4 switch and the ALT 3-4 switch in the SOURCE matrix (20) and you'll get that channel, all by itself, in the CONTROL ROOM (48) and PHONES (42).

MUTE/ALT 3-4 is one of those features that can bewilder newcomers, so take your time and play around with it. Once you've got it down, you'll probably think of a hundred uses for it!

17. Channel Fader

The fader controls the channel's level... from off to unity gain at the "U" marking, on up to 10 dB of additional gain.



"U" Like Unity Gain

Mackie mixers have a "U" symbol on almost every level control. This "U" stands for "unity gain," meaning no change in signal level. Once you have adjusted the input signal to line-level, you can set every control at "U" and your signals will travel through the mixer at optimal levels. What's more, all the labels on our level controls are measured in decibels (dB), so you'll know what you're doing level-wise if you choose to change a control's settings.

18. Signal Level LEDs

These LEDs indicate the channel's signal level after the GAIN and EQ controls, but just prior to the channel's fader. So even if the fader is turned down, you can see if a signal is present.

If you've followed the "Set the Levels" procedure, the -20 and 0 LEDs should light frequently, the +10 LED should light occasionally, and the OL (Overload) LED should not light at all. If the OL LED is blinking frequently, the signal is probably distorted from overdriving the input. Either turn down the GAIN control or turn down the signal at its source.

19. SOLO Switch

This handy switch allows you to hear signals through your headphones or control room outputs without having to route them to the MAIN or ALT 3-4 mixes. Folks use solo in live work to preview channels before they are let into the mix, or just to check out what a particular channel is up to anytime during a session. You can solo as many channels at a time as you like.

Soloed channels are sent to the SOURCE mix, which ultimately feeds your CONTROL ROOM, PHONES, and Meters. Whenever SOLO is engaged, all SOURCE (20) selections (MAIN MIX, ALT 3-4, TAPE, and FIREWIRE) are defeated, to allow the soloed signal to do just that—solo!

Note: The solo signal is pre-fader, so you can hear it even when the channel's fader is turned down.

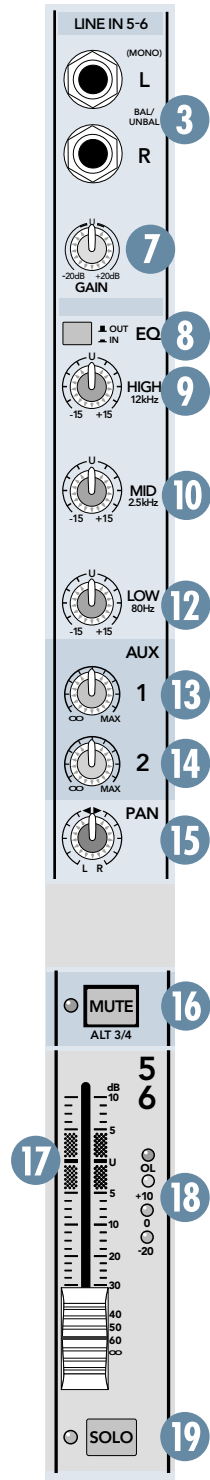

Stereo Channel

Control Room Matrix, Metering, and Phones

Typically, the engineer sends the MAIN MIX to an audience (if live) or to a mixdown deck (if recording). But what if the engineer needs to hear something other than the MAIN MIX in the control room or headphones? With the Onyx 1220, the engineer has several choices of what to listen to. This is one of those tricky parts, so buckle up.

20. CONTROL ROOM/PHONES SOURCE

Using the SOURCE switches, you can choose to listen to any combination of MAIN MIX, ALT 3-4, TAPE, and FIREWIRE (optional). By now, you probably know what the MAIN MIX is. ALT 3-4 is that additional stereo mix bus. TAPE is the stereo signal coming in from the TAPE IN RCA jacks. FIREWIRE is a 2-track feed coming in through the optional FireWire card from your computer.

Selections made in the SOURCE matrix deliver stereo signals to the CONTROL ROOM, PHONES, and Meters. With no switches engaged, there will be no signal at these outputs and no meter indication.

The exception to that is the SOLO function. Regardless of the SOURCE matrix selection, engaging a channel's SOLO switch will replace that selection with the SOLO signal, also sent to the CONTROL ROOM, PHONES, and Meters.

21. ASSIGN TO MAIN MIX

Let's say you're doing a live show. Intermission is nearing and you want to play a soothing CD for the crowd to prevent them from becoming antsy. Then you think, "But I have the CD player plugged into the TAPE inputs, and that never gets to the MAIN OUTPUTS!" Oh, but it does. Simply engage this switch and your SOURCE matrix selection, after going through the CONTROL ROOM level control, will feed into the MAIN MIX, just as if it were another stereo channel.

What if you have a playlist of MP3 files on your laptop you want to play during the break? Get the optional FireWire card and engage the FIREWIRE button to play your MP3s directly from your computer, through the SOURCE matrix, and into the MAIN MIX.

Another handy use for this switch is to enable the ALT 3-4 mix to become a submix of the MAIN MIX, using the CONTROL ROOM level control.

Side effects: 1) Engaging this switch also feeds any soloed channels into the MAIN MIX, which may be the last thing you want. 2) If you have MAIN MIX as your SOURCE matrix selection and then engage ASSIGN TO

MAIN MIX, the MAIN MIX lines to the SOURCE matrix will be disconnected from the CONTROL ROOM and PHONES outputs, to prevent feedback. Then again, why on earth would anyone want to assign the MAIN MIX to the MAIN MIX?



WARNING: Pushing in both the TAPE button (in the SOURCE matrix) and ASSIGN TO MAIN MIX (21) can create a feedback path between TAPE IN and TAPE OUT. Make sure your tape deck is not in record, record-pause, or input monitor mode when you engage these switches, or make sure the CONTROL ROOM knob (22) is turned all the way down (off).

22. CONTROL ROOM Knob

This controls the volume at the CONTROL ROOM outputs, from off (∞) to maximum gain (MAX). It also controls the level of the control room signal going to the MAIN OUTS when ASSIGN TO MAIN MIX is selected in the CONTROL ROOM/PHONES SOURCE matrix.

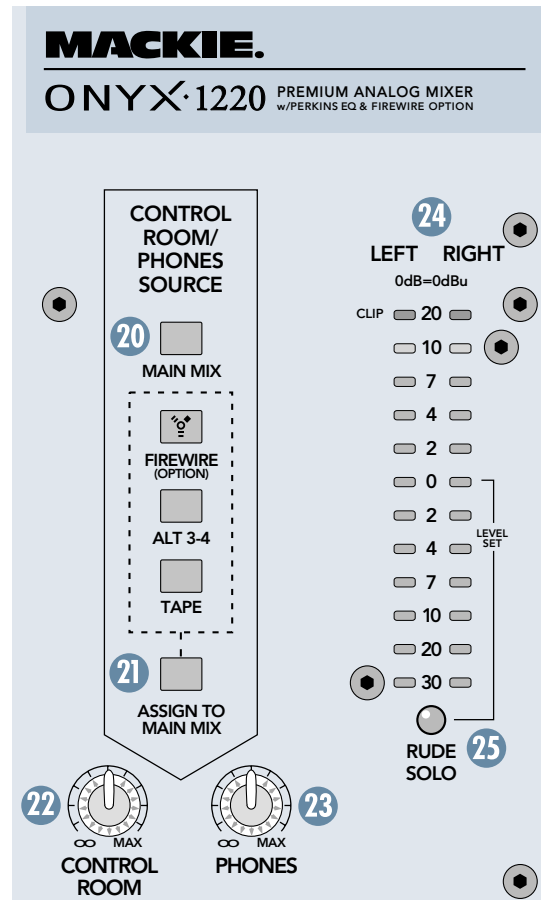

23. PHONES Knob

This controls the volume at the PHONES output, from off (∞) to maximum gain (MAX).

24. LEFT/RIGHT Level Meters

The Onyx 1220's peak meters are made up of two columns of twelve LEDs, with three colors to indicate different ranges of signal level, traffic light style. They range from -30 at the bottom, to 0 in the middle, to $+20$ (CLIP) at the top.

The 0 LED in the middle is labeled LEVEL SET to show where the level should be when adjusting a channel's gain in the solo mode, as described in "Set the Levels" on page 5.

If nothing is selected in the CONTROL ROOM/PHONES SOURCE matrix (20) and no channels are in SOLO, the meters won't do anything. To display a signal level, a source must be selected in the CONTROL ROOM/PHONES SOURCE matrix, which feeds the CONTROL ROOM (48) and PHONES (42) outputs. The meters reflect the program level of the selected source prior to the CONTROL ROOM and PHONES level knobs.

The reason for this is because you want the meters to reflect what the engineer is listening to, and as we've covered, the engineer is listening either to the CONTROL ROOM outputs or the PHONES outputs. The only difference is that while the listening levels are controlled by the CONTROL ROOM and PHONES knobs, the meters indicated the SOURCE mix before those knobs, giving you the real facts at all times, even if you're not listening at all.

When a channel is soloed, the meters change to reflect the level of that channel's signal level, pre-fader.



You may already be an expert at the world of "+4" (+4 dBu=1.23 V) and "-10" (-10 dBV=0.32 V) operating levels. What makes a mixer one or the other is the relative 0 dB VU (or 0 VU) chosen for the meters. A "+4" mixer, with +4 dBu pouring out the back will actually read 0 VU on its meters. A "-10" mixer, with a -10 dBV signal trickling out will read, you guessed it, 0 VU on its meters. So when is 0 VU actually 0 dBu? Right now!

Mackie mixers show things as they really are. When 0 dBu (0.775 V) is at the outputs, it shows as 0 dB VU on the meters. What could be easier? By the way, the most wonderful thing about standards is that there are so many to choose from.

Thanks to the Onyx 1220's wide dynamic range, you can get a good mix with peaks flashing anywhere between -20 and $+10$ dB on the meters. Most amplifiers clip at about $+10$ dBu, and some recorders aren't so forgiving either. For best real-world results, try to keep your peaks between "0" and "+7."

Remember, audio meters are just tools to help assure you that your levels are "in the ballpark." You don't have to stare at them (unless you want to).

25. RUDE SOLO Light

This large green LED flashes on and off when a channel's solo is active, as an additional reminder beyond the indicating LEDs next to each SOLO button. If you work on a mixer that has a solo function with no indicator lights and you happen to forget you're in solo mode, you can easily be tricked into thinking that something is wrong with your mixer. Hence, the RUDE SOLO light. It's especially handy at about 3 am when no sound is coming out of your monitors but your multitrack is playing back like mad.

Auxiliary Section

This section includes the AUX MASTERS (Sends) and the AUX RETURNS. These can be a bit confusing to the uninitiated, so here's the whole idea behind aux sends and returns: sends are outputs and returns are inputs. AUX SENDS tap signals off the channels, via the AUX knobs (13/14), mix these signals together, then send them out the AUX SEND jacks (38).

These outputs are fed to the inputs of an external processor like a reverb or digital delay. From there, the outputs of this external device are fed back to the mixer's AUX RETURN jacks (39). Then these signals are sent through the AUX RETURN level controls (28), and finally delivered to the MAIN MIX (36).

So, the original "dry" signals go from the channels to the MAIN MIX and the affected "wet" signals go from the AUX RETURNS to the MAIN MIX, and once mixed together, the dry and wet signals combine to create a glorious sound!

They can also be used to provide another mix for stage monitors, for example. In this case, the AUX RETURNS aren't used to return the signal. Instead, they can be used as additional stereo inputs.

26. AUX 1 and AUX 2 MASTER

The AUX MASTERS provide overall control over the AUX SEND levels, just before they are delivered to the AUX SEND outputs (38). These knobs go from off (∞) to +15 dB when turned all the way up.

This is usually the knob you turn up when the lead singer glares at you, points at his stage monitor, and sticks his thumb up in the air. (It would follow that if the singer stuck his thumb down, you'd turn the knob down, but that never happens.)

27. AUX 1 and 2 PRE/POST

The PRE/POST switches determine whether the AUX SEND signal is tapped from the channel before the fader (pre-fader) or after the fader and MUTE button (post-fader). Typically, you use a pre-fader send for monitors so you can control the monitor levels independently from the MAIN MIX. Use a post-fader send for effects, so that the "wet" signal level follows the "dry" signal level.

Both pre- and post-fader sends are affected by the EQ controls (unless the EQ is bypassed, of course).

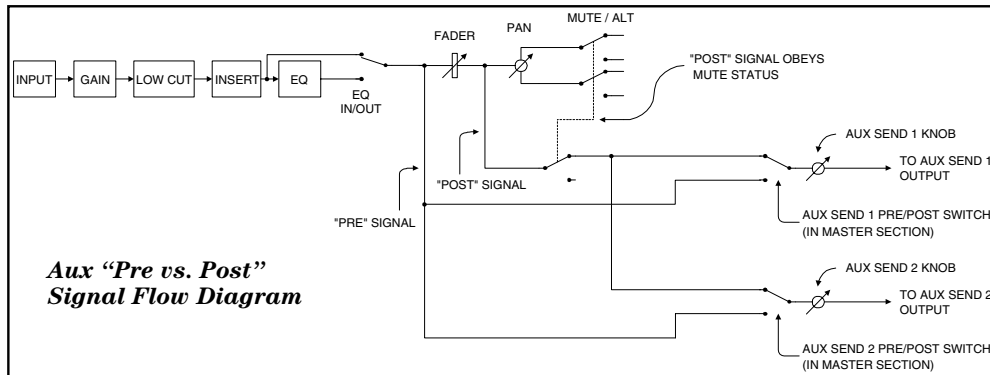

28. AUX 1 and 2 RETURN

These two controls set the overall level of effects received from the stereo AUX RETURN 1 and 2 inputs. These controls range from off (∞) to +10 dB of gain when fully clockwise, to compensate for low-level effects.

Signals passing through the AUX RETURN level controls proceed directly to the MAIN MIX bus where they are combined with the other channels just before the MAIN MIX fader (36).

29. FX TO MON Switch

This switch routes the signal from AUX RETURN 2 to the AUX 1 SEND instead of the MAIN MIX bus. This allows you to use an external effects device, like a reverb or delay, exclusively for the monitors. When this switch is pushed in, the effects signals coming into the AUX RETURN 2 jacks are combined with the signals coming from all of the channel AUX 1 send controls.

TALKBACK Section

The talkback feature allows the engineer to communicate with the talent either through the PHONES outputs (42) or the AUX 1-2 outputs (38). A talkback microphone is built into the Onyx 1220, or you have the option of connecting an external microphone at the TALKBACK MIC XLR connector (45) on the rear panel, which may be preferable in live or noisy situations.

30. Internal TALKBACK MIC

This is where the built-in talkback microphone is located. This is an omni-directional dynamic microphone, so it will pick up your voice from anywhere in front of the mixer.

31. TALKBACK LEVEL

Use this knob to control the level of the talkback signal being routed to the PHONES or AUX 1-2 outputs. This controls the talkback level for either the internal or external TALKBACK MICs.

You should start with the TALKBACK LEVEL control turned down, and then slowly turn it up until you get confirmation from whoever is listening to headphones or monitors that they can hear you. Once you have set the level, you can leave it there for the duration of the session (or the gig).

32. EXTERNAL MIC Switch

If you are in a noisy environment, the built-in talkback mic may not work as well because it picks up the ambient noise as well as your voice. You will probably have better results if you use an external microphone that you can talk directly into.

If you are using an external mic, you must push in the EXTERNAL MIC switch. The indicating LED lets you know when the switch is pushed. When the switch is out, the built-in TALKBACK MIC is used, regardless of whether or not you have an external mic plugged in. When the switch is pushed in, the built-in mic is disconnected and only the external mic is used.

33. TALKBACK to PHONES

Push in the CR/PHONES switch to route the talkback signal to the PHONES (42) output. Use this to communicate with the talent in the studio through the headphones during a recording session. When the talkback circuit is activated (by pushing the TALKBACK (35) switch), the CONTROL ROOM outputs are attenuated by 20 dB to allow the engineer's voice to come through loud and clear.

34. TALKBACK to AUX 1-2

This switch routes the talkback signal to the AUX 1 and 2 outputs (38). Use this to communicate with the musicians on-stage through their monitors during a live performance.

By the way, it is okay to have both destination switches pushed in at the same time. The talkback signal will be routed to both destinations. But if you don't have either of the destination switches pushed in, the talkback signal won't go anywhere. You might as well be talking to a brick wall.

35. TALKBACK Switch

This is a momentary switch, meaning it's only active when you hold the switch down. As long as you hold this switch down, the talkback signal is routed to the outputs determined by the destination switches (33/34). Release the switch, and the talkback circuit is turned off.

MAIN MIX and POWER LED

These are a few more important features that shouldn't be overlooked.

36. MAIN MIX Fader

The MAIN MIX fader controls the output level just before the MAIN OUTPUTS (1/4" and XLR) (40/46) and the TAPE OUTPUTS (41). When MAIN MIX is selected for the CONTROL ROOM/PHONES SOURCE (20), the MAIN MIX fader also controls the main mix level in the CONTROL ROOM and PHONES outputs (48/42).

When the fader is fully down, the MAIN MIX is off. The "U" marking indicates unity gain, and fully up provides 10 dB of additional gain. Typically, this fader is set near the "U" label and left alone, but it can be used for song fade-outs or quick system-wide mutes.

37. POWER LED

This LED performs one function—it lets you know when the Onyx 1220 is turned on and ready to go!

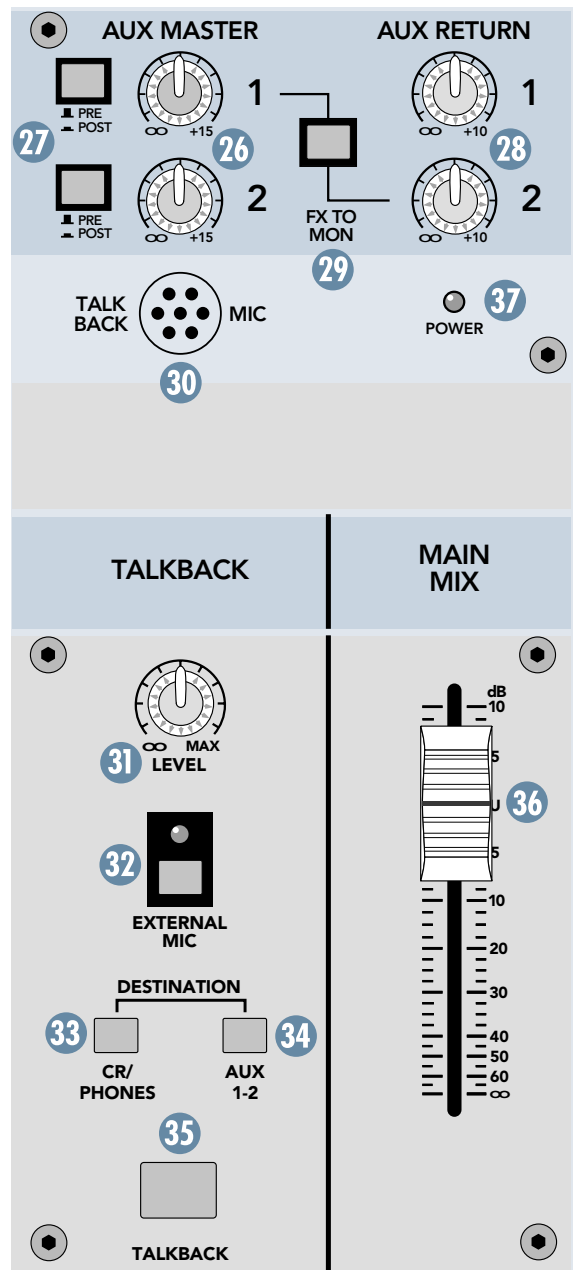

Front Panel Connectors

Besides the channel strip MIC and LINE input connectors, there are some other connectors located on the front panel for easy access.

38. AUX SEND 1 and 2

These 1/4" TRS output connectors provide balanced or unbalanced line-level signals for connecting to the inputs of effects devices or stage monitor amplifiers.

39. AUX RETURN 1 and 2

These 1/4" TRS input connectors accept balanced or unbalanced line-level stereo signals from an external processor or other device. The stereo AUX RETURNS use jack normalizing, like the stereo inputs on channels 5-12. If a signal is plugged into the LEFT (MONO) side and nothing is plugged into the RIGHT side, the signal is automatically connected to both LEFT and RIGHT sides. As soon as something is plugged into the RIGHT side, the normalised connection is broken and the LEFT and RIGHT inputs become stereo inputs (LEFT goes to the LEFT MAIN OUT and RIGHT goes to the RIGHT MAIN OUT).

40. MAIN OUT

These 1/4" TRS output connectors provide balanced or unbalanced line-level signals. This is the same signal that appears at the XLR MAIN OUTPUTS (46) on the rear panel, except 6 dB lower in level. Connect these to the next device in the signal chain like an external processor (graphic equalizer or compressor/limiter), or directly to the inputs of the main amplifier.

41. TAPE IN/OUT

These RCA jacks are used to connect to the inputs and outputs of a tape recorder or other recording device.

The TAPE IN jacks accept an unbalanced signal from a tape recorder or other signal source (could be a CD player, if you want) using standard hi-fi hookup cables. The signal is routed to the CONTROL ROOM/PHONES SOURCE matrix (20). Push in the TAPE button to route the tape input to the CONTROL ROOM and PHONES outputs (48/42). This allows you to playback recordings of your mixes.

Push in the ASSIGN TO MAIN MIX button (21) to route the tape input to the MAIN OUTs (40/46). This allows you to playback music between sets over the main PA speakers.



WARNING! Pushing TAPE in the SOURCE matrix and ASSIGN TO MAIN MIX can create a feedback path between TAPE IN and TAPE OUT. Make sure your tape deck is not in record, record pause, or input monitor mode when you engage these switches, or make sure the CONTROL ROOM level control is turned all the way down.

The TAPE OUT jacks produce an unbalanced signal that is tapped off the MAIN OUTs. Normally, you would connect these to the inputs of a recorder, but you can use them as an extra set of main outputs for feeding another zone, for example.

42. PHONES

This is where you plug in your stereo headphones. It is a 1/4" TRS stereo jack and provides the same signal that is routed to the CONTROL ROOM outputs (48), as determined by the CONTROL ROOM/PHONES SOURCE matrix (20). The volume is controlled with the PHONES knob (23), right next to the CONTROL ROOM knob.



WARNING: The headphone amp is designed to drive any standard headphones to a very loud level. We're not kidding! It can cause permanent hearing damage. Even intermediate levels may be painfully loud with some headphones. BE CAREFUL! Always start with the PHONES level (23) turned all the way down before connecting headphones to the PHONES jack. Keep it down until you've put on the headphones. Then turn it up slowly. Why? Always remember: *"Engineers who fry their ears, find themselves with short careers."*

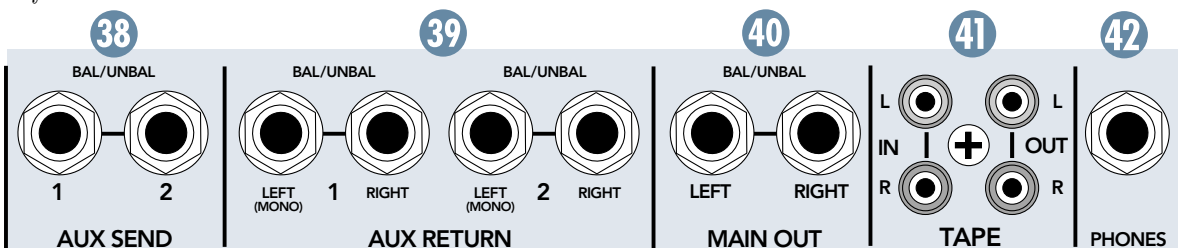

Rear Panel

There are just a few more connectors and switches to talk about and you'll have completed your tour of the Onyx 1220. Hang in there!

43. POWER Switch

This one is self-explanatory. When the POWER switch is turned ON, power is supplied to the Onyx 1220 and the POWER LED on the front panel lights up.

44. Power Receptacle

This is a standard 3-prong IEC power connector. Connect the detachable linecord (included in the box with your Onyx 1220) to the power receptacle, and plug the other end of the linecord into an AC outlet. The Onyx 1220 has a universal power supply that can accept any AC voltage ranging from 100 VAC to 240 VAC. No need for voltage select switches. It will work virtually anywhere in the world. That's why we call it a "Planet-Earth" power supply! This also means that it is less susceptible to voltage sags or spikes, providing greater electromagnetic isolation and better protection against AC line noise.

45. TALKBACK MIC

This is where you plug in your external talkback microphone if you need to have one. This female XLR connector has +48 VDC phantom power always applied, so you can use dynamic or condenser microphones.

Note: Almost all dynamic microphones can be used with phantom power, but you might want to check the documentation that came with your microphone to be sure.

46. RIGHT/LEFT MAIN OUTPUTS

These male XLR connectors provide a balanced line-level signal that represent the end of the mixer chain, where your fully mixed stereo signal enters the real world. Connect these to the inputs of your main power amplifiers, powered speakers, or serial effects processor (like a graphic equalizer or compressor/limiter). It provides a fully balanced signal that is 6 dB higher than the 1/4" TRS MAIN OUT jacks on the front panel.

47. MAIN OUTPUT LEVEL

When this switch is out (+4 dB), the XLR MAIN OUTPUTS provide a +4 dBu line-level signal. When the switch is pushed in (MIC), the signal is attenuated by 40 dB to a microphone level. You can connect the XLR MAIN OUTPUTS to the microphone inputs of another mixer, providing a submix for keyboards or drums, for example, in a live sound application.

Note: You can safely plug this output into a microphone input that provides 48 V phantom power.

48. CONTROL RM Outputs

These 1/4" TRS jacks provide a balanced line-level signal that can be used to provide another main mix output (with MAIN MIX selected in the CONTROL ROOM/PHONES SOURCE) (20), or to monitor the ALT 3-4 outputs, TAPE inputs, or a 2-track feed from your computer (with the optional FireWire card installed).

Connect these outputs to the inputs of an amplifier, powered speaker, or recording device.

49. ALT 3-4 OUT

These 1/4" TRS jacks provide a balanced line-level signal that can provide an alternate stereo mix for recording or subgrouping. Connect these outputs to the inputs of an amplifier, powered speaker, or recording device.

Note: The ALT 3-4 OUT doesn't have a master level control. All the channels assigned to the ALT 3-4 bus are summed together (post-fader and pan) and sent directly to the ALT 3-4 OUT.

50. CHANNEL INSERT

These 1/4" TRS jacks provide a send and return point for channels 1-4. Use the CHANNEL INSERT jacks to connect serial effects devices such as compressors, equalizers, de-essers, or filters to each individual channel.

The INSERT points are after the GAIN and Low Cut controls, but before the EQ and Fader controls. The send (tip) is low-impedance, capable of driving any device. The return (ring) is high-impedance and can be driven by almost any device.

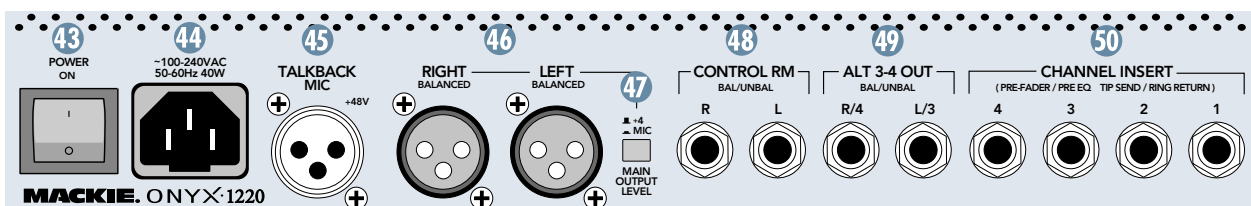

Special insert cables are available, specially designed for this kind of insert jack. They are wired as follows:

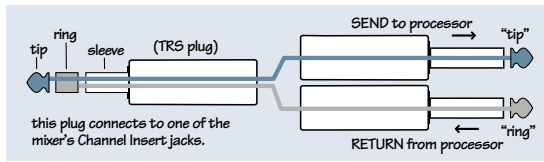

- Tip = Send (output to effects device)
- Ring = Return (input from effects device)
- Sleeve = Common ground (connect shield to all three sleeves)

Besides being used for inserting external devices, these jacks can also be used as channel direct outputs; post-TRIM, post-LOW CUT, and pre-EQ. This is an unbalanced direct out, in contrast to the RECORDING OUTS on the rear panel, which are balanced direct outputs, post-TRIM, pre-LOW CUT.

Here are three ways you use the INSERT jacks:

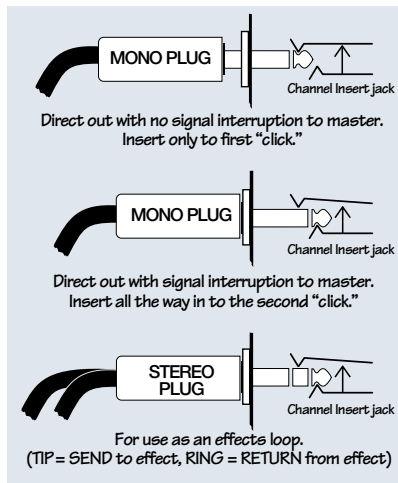

51. RECORDING OUTS

These two DB-25 connectors provide balanced direct outputs for channels 1-4 and 5-12, respectively. They are designed to be connected directly to a recorder's analog inputs, and use the TASCAM standard pinout for analog signal connections (the same standard used on the analog cards for the Mackie D8B and Hard Disk Recorder).

The signal at the RECORDING OUTS comes just after the input GAIN control, and before the Low-Cut switch, INSERT jacks, and EQ. This way you can EQ a channel, connect a compressor or other dynamics processor to the INSERT jack, and adjust the channel fader to suit your live mix, but it has no effect on the signal going to the recorder. This provides maximum flexibility for the mixdown stage.

See Appendix B for a wiring diagram of these connectors.

52. FIREWIRE I/O OPTION

Okay, we saved the best for last. FireWire (a.k.a. IEEE 1394) is a high-speed serial I/O interface for connecting digital devices, with more than 30 times the bandwidth of USB 1.1. You can install the optional Onyx FireWire interface card in this slot, which provides three FireWire connectors for transferring digital audio to and from your laptop computer or digital audio workstation (DAW) with absolute zero latency.

The FireWire interface provides the direct outputs for all twelve channels and the Left/Right Mix. The Left/Right Mix is pre-fader at the FireWire output, so its level is independent of the MAIN MIX fader (important for live gigs). Instead, it has a rotary level control that provides a 10 dB boost or cut for the Left/Right mix, to optimize the level for the recorder or DAW. Use the FireWire interface to record a live performance directly to your laptop, which you can mixdown to a stereo mix later. Or you can use it to turn your Onyx mixer into a high-quality computer audio interface for your DAW.

The card also provides a return for two channels from a DAW or laptop, which can be routed through the CONTROL ROOM/PHONES SOURCE matrix (20) via the FIREWIRE button, to monitor the computer audio through your control room speakers or headphones (or through the main speakers if ASSIGN TO MAIN MIX (21) is selected).

The FireWire interface works with both PC (ASIO for Windows XP) and Mac (Core Audio for Mac OS 10.3 or higher). As an added bonus, we include a free copy of Tracktion, our multitrack recording and sequencing software application for PC or Mac.

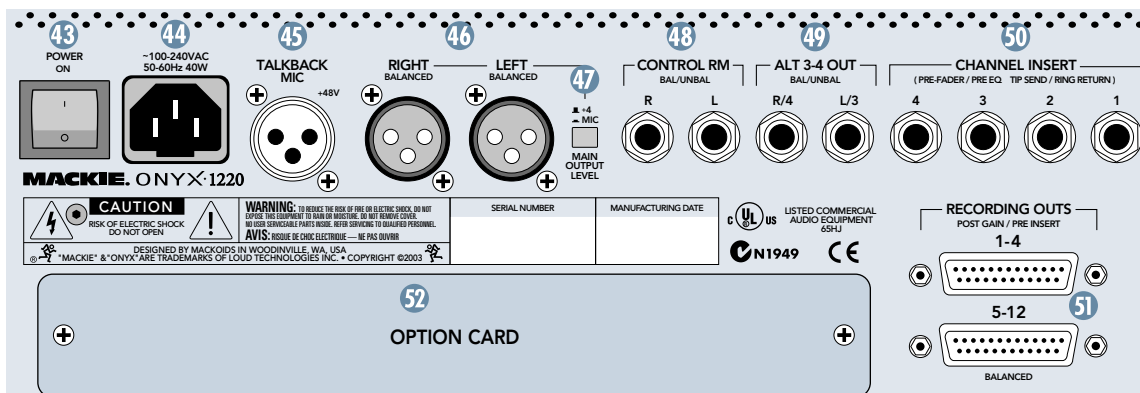

Appendix A: Service Information

Warranty Service

Details concerning Warranty Service are spelled out in the Warranty section on page 31.

If you think your Onyx mixer has a problem, please do everything you can to confirm it before calling for service. Doing so might save you from the deprivation of your Onyx mixer and the associated suffering.

These may sound obvious to you, but here are some things you can check. Read on.

Troubleshooting

No Power

- Our favorite question: Is it plugged in?
- Make sure the power cord is securely seated in the IEC socket (44) and plugged all the way into the AC outlet.
- Make sure the AC outlet is live (check with a tester or lamp).
- Is the POWER (43) switch on? Make sure the POWER switch on the rear panel is in the ON position (up).
- Is the POWER LED (37) on the front panel illuminated? If not, make sure the AC outlet is live. If so, refer to "No Sound" below.
- Are all the lights out in your building? If so, contact your local power company to get power restored.
- If the POWER LED is not illuminated, and you are certain that the AC outlet is live, it will be necessary to have your Onyx 1220 serviced. *There are no user serviceable parts inside.* Refer to "Repair" at the end of this section to find out how to proceed.

Bad Channel

- Is the MUTE/ALT 3-4 switch (16) in the correct position?
- Is the input GAIN control (7) for the channel turned up?
- Is the fader (17) turned up?
- Is the signal source turned up? Make sure the signal level from the selected input source is high enough to light up some of the INPUT meter (18) LEDs next to the channel's fader.
- If it is channel 1 or 2, make sure the MIC/HI-Z switch (4) is in the right position.

- Is there something plugged into the CHANNEL INSERT jack (50)? Try unplugging any INSERT devices (channels 1-4 only).
- Try the same source signal in another channel, set up exactly like the suspect channel.

Bad Output

- Is the associated level control (if any) turned up?
- If it's one of the MAIN OUTPUTS, try unplugging all the others. For example, if it's the 1/4" LEFT MAIN OUT, unplug the RCA LEFT TAPE OUT and XLR LEFT OUTPUT. If the problem goes away, it's not the mixer.
- If it's a stereo pair, try switching them around. For example, if a left output is presumed dead, switch the left and right cords at the mixer end. If the problem stays on the left side, it's not the mixer.

Bad Sound

- Is the input connector plugged completely into the jack?
- Is it loud and distorted? Make sure the input GAIN control for the input is set correctly. Reduce the signal level on the input source if possible.
- If possible, listen to the signal with headphones plugged into the input source device. If it sounds bad there, it's not the Onyx causing the problem.

Noise/Hum

- Turn down the AUX RETURN knobs (28). If the noise disappears, it's coming from whatever is plugged into the AUX RETURNS (39).
- Turn down each channel, one by one. If the noise disappears, it's coming from whatever is plugged into that channel.
- Check the signal cables between the input sources and the Onyx. Disconnect them one by one. When the noise goes away, you'll know which input source is causing the problem.
- Sometimes it helps to plug all the audio equipment into the same AC circuit so they share a common ground.

Repair

Service for Mackie products is available at our galactic headquarters, located in sunny Woodinville, Washington. Service for Mackie products living outside the United States can be obtained through local dealers or distributors.

If your Onyx 1220 needs service, follow these instructions:

1. Review the preceding troubleshooting suggestions. Please.
2. Call Tech Support at 1-800-898-3211, 7 am to 5 pm PST, to explain the problem and request an RA (Return Authorization) number. Have your Onyx 1220's serial number ready. **You must have an RA number before you can obtain service at the factory.**
3. Keep this owner's manual and the detachable line-cord. We don't need them to repair the mixer.
4. Pack the mixer in its original package, including endcaps and box. This is **VERY IMPORTANT**. When you call for the RA number, please let Tech Support know if you need new packaging. *Mackie is not responsible for any damage that occurs due to non-factory packaging.*
5. Include a legible note stating your name, shipping address (no P.O. boxes), daytime phone number, RA number, and a detailed description of the problem, including how we can duplicate it.
6. Write the RA number in **BIG PRINT** on top of the box. Units sent to us without the RA number will be refused.
7. Ship the mixer to us. We suggest insurance for all forms of cartage. Ship to this address:

MACKIE
SERVICE DEPARTMENT
16220 Wood-Red Road NE
Woodinville, WA 98072
8. We'll try to fix the mixer within three to five business days. Ask Tech Support for the latest turn-around times when you call for your RA number. The mixer must be packaged in its original packing box, and must have the RA number on the box. Once it's repaired, we'll ship it back the same way in which it was received. This paragraph does not necessarily apply to non-warranty repair.

Note: You must have a sales receipt from an Authorized Mackie Dealer to qualify for a warranty repair.

Need Help?

**You can reach a technical support representative
Monday through Friday
from 7 AM to 5 PM PST at:**

1-800-898-3211

**After hours, visit www.mackie.com and click Support,
or email us at: techmail@mackie.com**



Appendix B: Connections

XLR Connectors

Channels 1-4 use 3-pin female XLR connectors on the MIC inputs. They are wired as follows, according to standards specified by the AES (Audio Engineering Society).

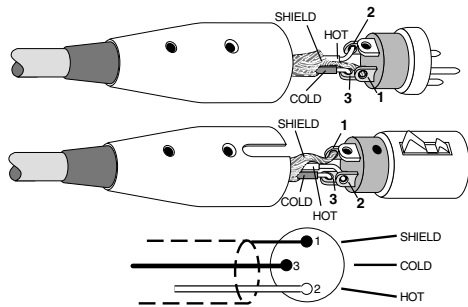

XLR Balanced Wiring:

- Pin 1 = Shield
- Pin 2 = Hot (+)
- Pin 3 = Cold (-)

1/4" TRS Phone Plugs and Jacks

“TRS” stands for Tip-Ring-Sleeve, the three connection points available on a stereo 1/4" or balanced phone jack or plug. TRS jacks and plugs are used for balanced signals and stereo headphones:

Balanced Mono

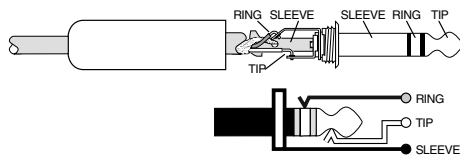

1/4" TRS Balanced Mono Wiring:

- Sleeve = Shield
- Tip = Hot (+)
- Ring = Cold (-)

Stereo Headphones

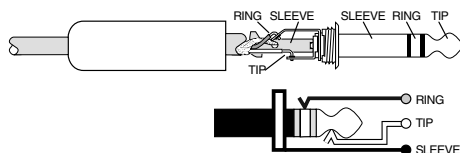

1/4" TRS Stereo Unbalanced Wiring:

- Sleeve = Shield
- Tip = Left
- Ring = Right

1/4" TS Phone Plugs and Jacks

“TS” stands for Tip-Sleeve, the two connection points available on a mono 1/4" phone jack or plug. They are used for unbalanced signals.

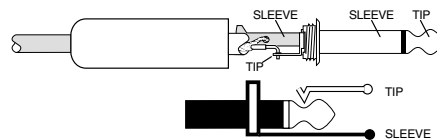

1/4" TS Unbalanced Wiring:

- Sleeve = Shield
- Tip = Hot (+)

RCA Plugs and Jacks

RCA-type plugs (also known as phono plugs) and jacks are often used in home stereo and video equipment and in many other applications. They are unbalanced and electrically equivalent to a 1/4" TS phone plug.

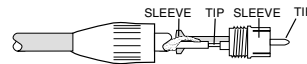

RCA Unbalanced Wiring:

- Sleeve = Shield
- Tip = Hot (+)

Unbalancing a Line

In most studio, stage, and sound reinforcement situations, there is a combination of balanced and unbalanced inputs and outputs on the various pieces of equipment. This usually will not be a problem in making connections.

- When connecting a balanced output to an unbalanced input, be sure the signal high (hot) connections are wired to each other, and that the balanced signal low (cold) goes to the ground (earth) connection at the unbalanced input. In most cases, the balanced ground (earth) will also be connected to the ground (earth) at the unbalanced input. If there are ground-loop problems, this connection may be left disconnected at the balanced end.

- When connecting an unbalanced output to a balanced input, be sure that the signal high (hot) connections are wired to each other. The unbalanced ground (earth) connection should be wired to the low (cold) and the ground (earth) connections of the balanced input. If there are ground-loop problems, try disconnecting the unbalanced ground (earth) connection from the balanced input ground (earth) connection, leaving the unbalanced ground connected to the balanced input low (cold) connection only.

In some cases, you may have to make up special adapters to interconnect your equipment. For example, you may need a balanced XLR female connected to an unbalanced 1/4" TS phone plug. Many common adapters can be found at your local electronics supply store.

The balanced-to-unbalanced connection has been anticipated in the wiring of Mackie jacks. A 1/4" TS plug inserted into a 1/4" TRS balanced input, for example, will automatically unbalance the input and make all the right connections. Conversely, a 1/4" TRS plug inserted into a 1/4" unbalanced input will automatically tie the ring (low or cold) to ground (earth).

TRS Send/Receive Insert Jacks

Mackie's single-jack inserts are three-conductor 1/4" TRS phone jacks. They are unbalanced, but have both the mixer output (send) and mixer input (return) signals in one connector.

The sleeve is the common ground (earth) for both signals. The send from the mixer to the external unit is carried on the tip, and the return from the unit to the mixer is on the ring.

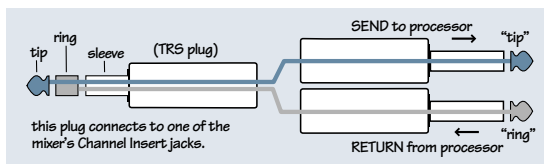

Using the Send Only on an Insert Jack

If you insert a 1/4" TS (mono) plug only partially (to the first click) into a Mackie insert jack, the plug will not activate the jack switch and will not open the insert loop in the circuit (thereby allowing the channel signal to continue on its merry way through the mixer).

This allows you to tap out the channel's signal at that point in the circuit without interrupting normal operation.



Note: Do not overload or short-circuit the signal you are tapping from the mixer. That will affect the internal signal.

If you push the 1/4" TS plug in to the second click, you will open the jack switch and create a direct out, which does interrupt the signal in that channel.

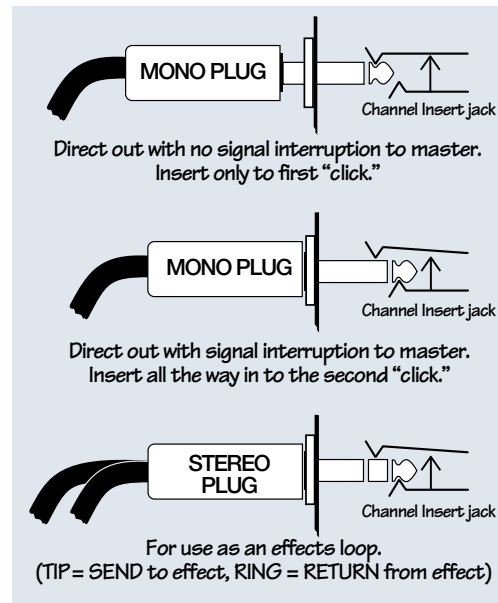

Mults and "Y"s

A mult or "Y" connector allows you to route one output to two or more inputs by simply providing parallel wiring connections. You can make "Y"s and mults for the outputs of both unbalanced and balanced circuits.



Remember: Only mult or "Y" an output into several inputs. If you need to combine several outputs into one input, you must use a mixer, not a mult or a "Y."

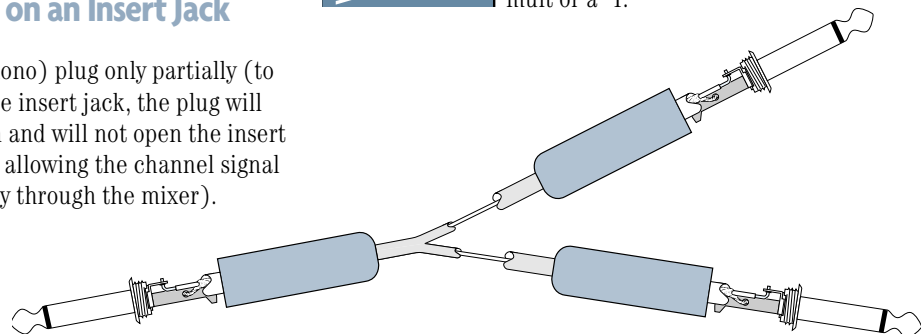

Y-Cord Splitter

DB25 Connectors

The RECORDING OUTS on the back of the Onyx 1220 provide balanced direct outputs for channels 1-12 on two female DB25 connectors. These connectors are pin-for-pin compatible with the analog (not TDIF) DB25 connectors found on TASCAM DTRS recorders, which has become an industry standard for many professional audio manufacturers. They are also the same pinout as the analog cards for the Mackie D8B and hard disk recorders.

Normally, each DB25 connector provides eight balanced line-level inputs or outputs. Since the Onyx 1220 has only 12 channels, the top DB25 connector (labeled 1-4) provides only four balanced direct outputs, while the bottom connector (labeled 5-12) provides eight.

	Signal Description	REC OUTS 1-4	REC OUTS 5-12		Signal Description	REC OUTS 1-4	REC OUTS 5-12
Pin 1	+	N/C	Ch12	Pin 14	-	N/C	Ch12
Pin 2	shield	N/C	Ch12	Pin 15	+	N/C	Ch11
Pin 3	-	N/C	Ch11	Pin 16	shield	N/C	Ch11
Pin 4	+	N/C	Ch10	Pin 17	-	N/C	Ch10
Pin 5	shield	N/C	Ch10	Pin 18	+	N/C	Ch 9
Pin 6	-	N/C	Ch 9	Pin 19	shield	N/C	Ch 9
Pin 7	+	Ch 4	Ch 8	Pin 20	-	Ch 4	Ch 8
Pin 8	shield	Ch 4	Ch 8	Pin 21	+	Ch 3	Ch 7
Pin 9	-	Ch 3	Ch 7	Pin 22	shield	Ch 3	Ch 7
Pin 10	+	Ch 2	Ch 6	Pin 23	-	Ch 2	Ch 6
Pin 11	shield	Ch 2	Ch 6	Pin 24	+	Ch 1	Ch 5
Pin 12	-	Ch 1	Ch 5	Pin 25	shield	Ch 1	Ch 5
Pin 13	N/C	---	---				

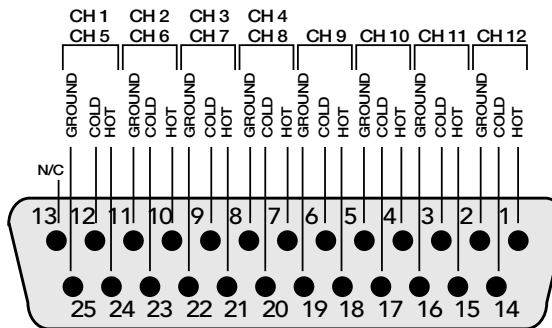

Several companies make DB25-to-DB25 cables specifically for audio, with proper shielding to reduce crosstalk and noise.

DB25 cables that break out to XLR, 1/4" TRS, or TT connectors for connecting to other mixers or audio gear are also readily available. See your Mackie dealer for details.

Appendix C: Technical Info

Onyx 1220 Specifications

Frequency Response

Mic Input to Main Output (Gain @ Unity)
 +0, -1 dB, 10 Hz to 50 kHz
 +0, -3 dB, <10 Hz to >100 kHz

Distortion (THD & IMD)

Mic Input to Main Output (@ +4 dBu output)
 THD: < 0.01%, 20 Hz to 20 kHz
 SMPTE IMD: < 0.005%

Dynamic Range

>113 dB (Mic In to Main Out)

Noise Floor

(20 Hz to 20 kHz Bandwidth, 150Ω source impedance)

Equivalent Input Noise (E.I.N.)
 -129 dBu @ +60 dB gain

Mic Output Noise:
 Recording Output: -100 dBu (minimum gain)

Residual Output Noise:
 Main Out: -97 dBu (Channel and Main Mix levels off)
 Main Out: -87 dBu (Channel and Main Mix levels at unity)

Common Mode Rejection Ratio (CMRR)

Mic In: >60 dB @ 1 kHz, Gain @ maximum

Crosstalk

Adjacent Inputs or Input to Output: < -75 dB @ 1 kHz
 Adjacent Inputs to Recording Outputs: < -90 dB @ 1 kHz

Input Gain Control Range

Mic In: 0 dB to +60 dB
 Line In: -20 dB to +40 dB, mono channels
 Line In: -20 dB to +20 dB, stereo channels

Phantom Power

+48 VDC

Equalization

Mono Channel EQ:
 High: ±15 dB @ 12 kHz
 Mid: ±15 dB, sweepable from 100 Hz to 8 kHz
 Low: ±15 dB @ 80 Hz

Stereo Channel EQ:
 High: ±15 dB @ 12 kHz
 Mid: ±15 dB @ 2.5 kHz
 Low: ±15 dB @ 80 Hz

Mixer Rated Output

Main: +4 dBu
 Aux Send: +4 dBu
 Control Room: +4 dBu
 Alt 3/4: +4 dBu
 Maximum Rated Output:
 +27 dBu @ Main XLR Outputs
 +21 dBu @ TRS Outputs

Maximum Input Levels

Mic Input: +21 dBu, Gain @ Unity
 Inst Input: +21 dBu, Gain @ -20 dB
 Mono Channel Line Input:
 +30 dBu, Gain @ Unity
 Stereo Channel Line Input:
 +21 dBu, Gain @ -20 dB
 Tape Input: +15 dBu
 Aux Return: +21 dBu

Maximum Voltage Gain

Mic Input to:
 Main Output (XLR): 85 dB
 Main Output (TRS): 79 dB
 Tape Output: 79 dB
 Aux Sends: 85 dB
 Control Rm Output: 89 dB
 Alt 3/4 Output: 64 dB
 Phones Output: 87 dB

Inst Input to:
 Main Output (XLR): 66 dB
 Main Output (TRS): 60 dB
 Tape Output: 60 dB
 Aux Sends: 66 dB
 Control Rm Output: 70 dB
 Alt 3/4 Output: 45 dB
 Phones Output: 68 dB

Stereo Line Input to:
 Main Output (XLR): 46 dB
 Main Output (TRS): 40 dB
 Tape Output: 40 dB
 Aux Sends: 45 dB
 Control Rm Output: 49 dB
 Alt 3/4 Output: 24 dB
 Phones Output: 47 dB

Tape Input to:
 Main Output (XLR): 31 dB
 Main Output (TRS): 25 dB
 Tape Output: 25 dB
 Control Rm Output: 16 dB
 Phones Output: 14 dB

Aux Return to:
 Main Output (XLR): 26 dB
 Main Output (TRS): 20 dB
 Tape Output: 20 dB
 Aux Send: 26 dB
 Control Rm Output: 29 dB
 Phones Output: 27 dB

Input Impedance

Mic Input: 2.4 kΩ, balanced
 Inst Input: 1 MΩ
 Mono Channel Line Input: 30 kΩ balanced;
 15 kΩ unbalanced
 Stereo Channel Line Input: 20 kΩ balanced;
 10 kΩ unbalanced
 Stereo Aux Returns: 20 kΩ balanced;
 10 kΩ unbalanced
 Tape In: 20 kΩ unbalanced

Output Impedance

Main: 100 Ω balanced, XLR outputs;
 300 Ω TRS outputs
 Recording Outputs: 300 Ω
 Control Room: 300 Ω
 Alt 3/4: 300 Ω
 Aux Sends: 300 Ω
 Tape Output: 2.0 kΩ
 Phones Output: 25 Ω

Physical Dimensions and Weight

Height: 17.3 in/439 mm
 Width: 13.9 in/353 mm
 Depth: 5.9 in/150 mm
 Weight: 16.0 lb/7.3 kg

Options

Onyx FireWire Interface Card
 Rack Mount Kit

Channel Level Set LED (Sensitivity)

0 dBu (normal operating level)

VU Meters

Main Left and Right, 12 segments:
 Clip (+20), +10, +7, +4, +2, 0, -2, -4, -7, -10, -20, -30
 0 LED = 0 dBu

AC Power Requirements

Power Consumption: 40 watts

Universal AC Power Supply:
 100 VAC – 240 VAC, 50-60 Hz

LOUD Technologies Inc. is always striving to improve our products by incorporating new and improved materials, components, and manufacturing methods. Therefore, we reserve the right to change these specifications at any time without notice.

“Mackie,” “Onyx,” and the “Running Man” are registered trademarks of LOUD Technologies Inc. All other brand names mentioned are trademarks or registered trademarks of their respective holders, and are hereby acknowledged.

©2004 LOUD Technologies Inc. All Rights Reserved.

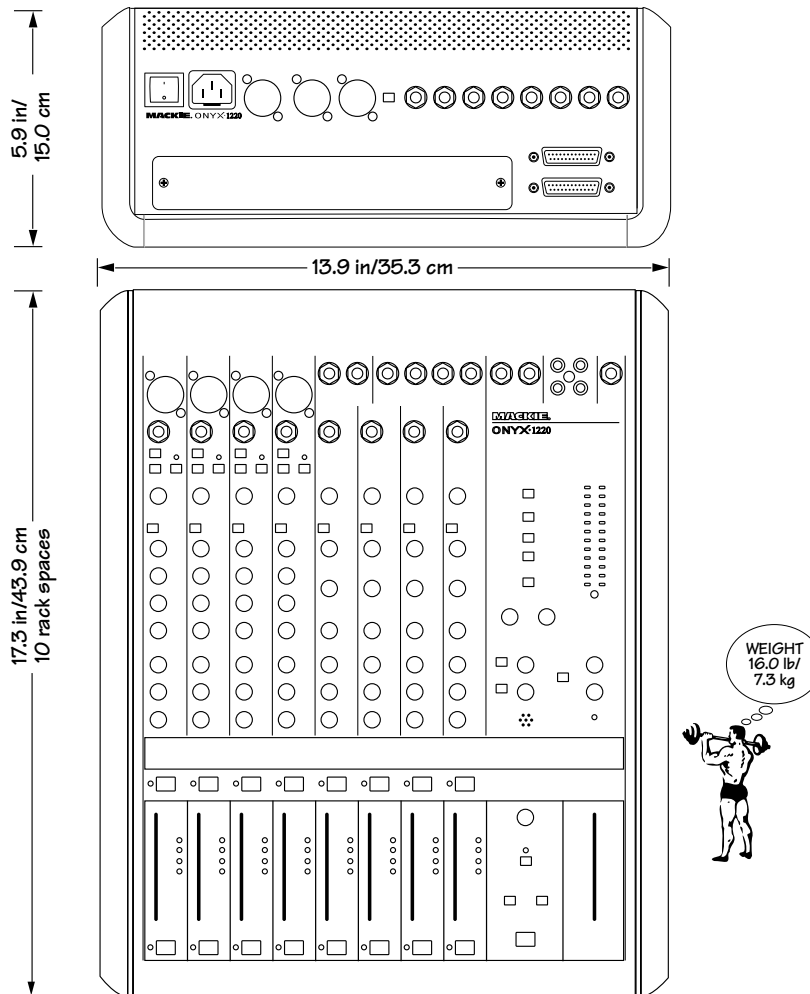

Onyx 1220 Block Diagram

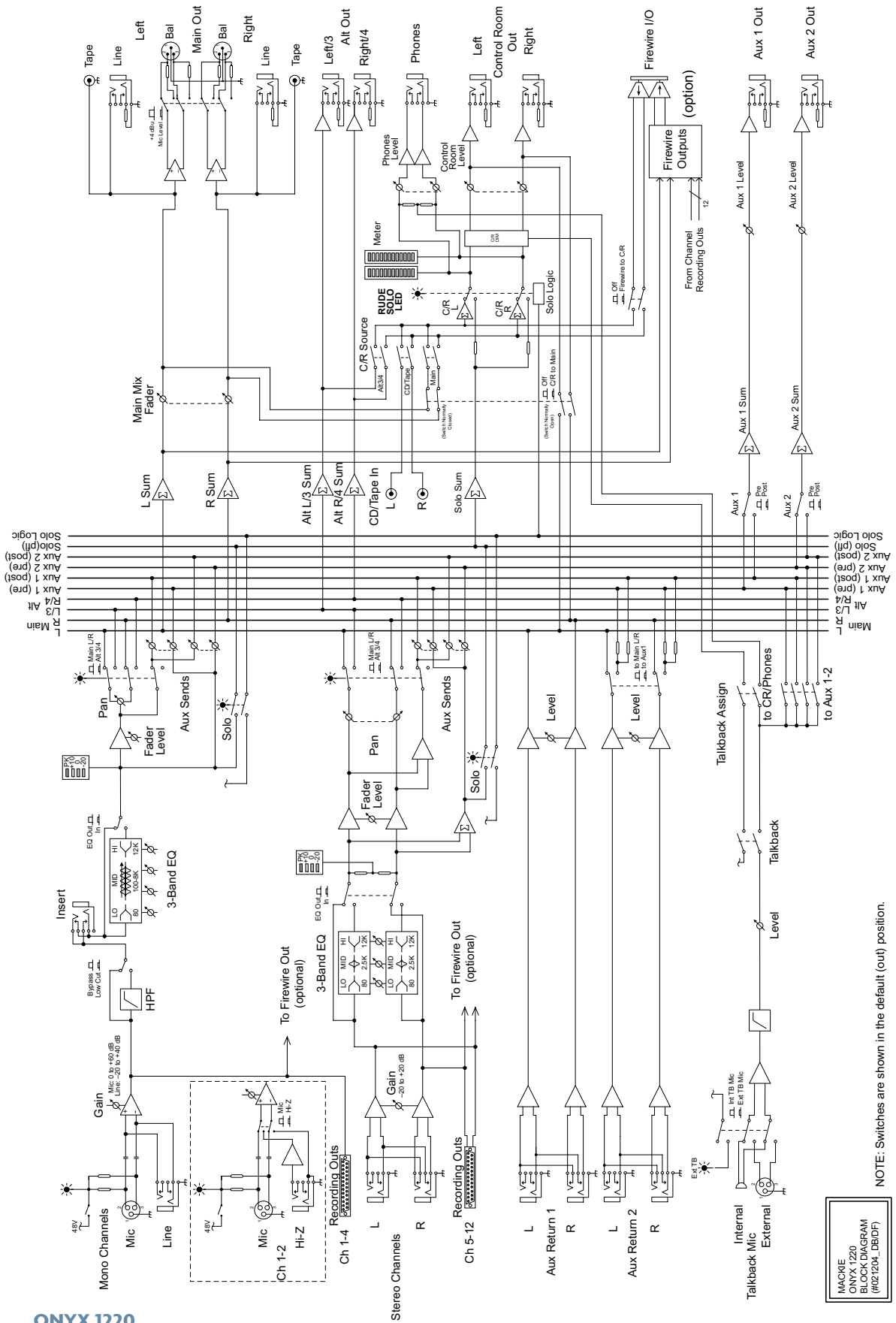

MAChIE
ONYX 1220
BLOCK DIAGRAM
(#021204_DBIDF)

NOTE: Switches are shown in the default (out) position.

Onyx 1220 Track Sheet

MACKIE
ONYX 1220
 PREMIUM ANALOG MIXER
WITH PERKINS EQ & FIREWIRE OPTION

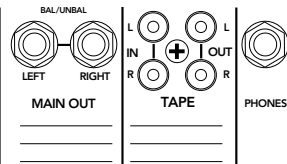
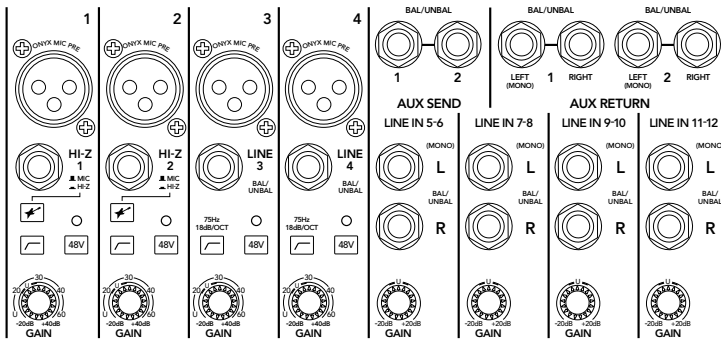

Session: _____
 Date: _____

NOTES:

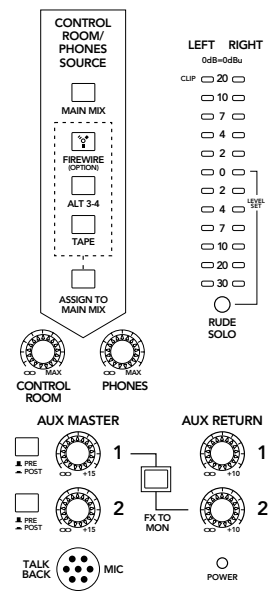
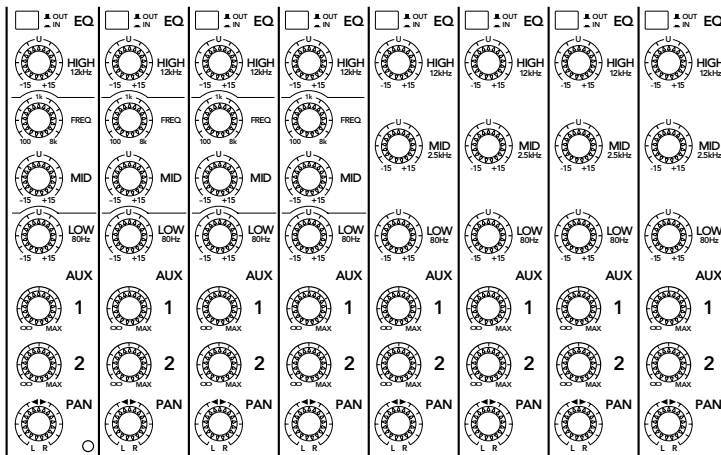

LEFT RIGHT
 0dB=0dBu
 CLIP 20
 10
 7
 4
 0
 2
 4
 7
 10
 20
 30
 RUDE SOLO

NOTES:

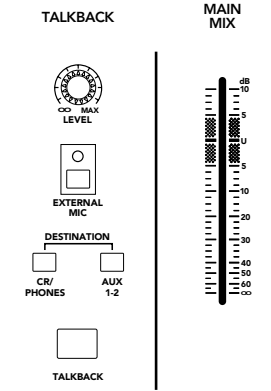
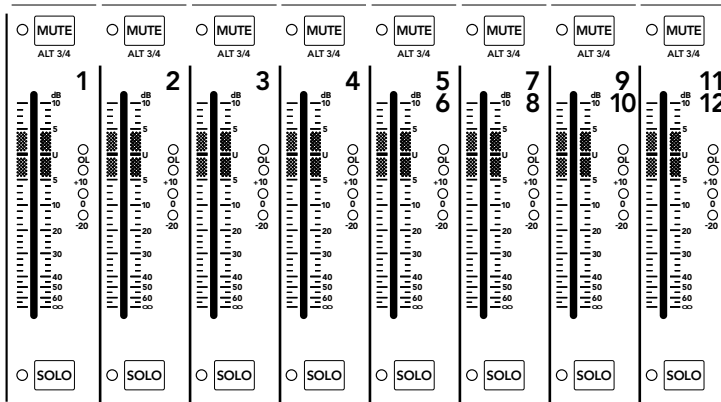

TALKBACK
 LEVEL
 EXTERNAL MIC
 DESTINATION
 CB/ PHONES
 AUX 1-2
 TALKBACK

MAIN MIX
 10
 5
 0
 -5
 -10
 -20
 -30
 -40
 -50
 -60
 -80

Onyx 1220 Track Sheet

The Other Side

MACKIE
ONYX 1220
 PREMIUM ANALOG MIXER
 24 CHANNELS • 24 TRACKS

Session: _____
 Date: _____

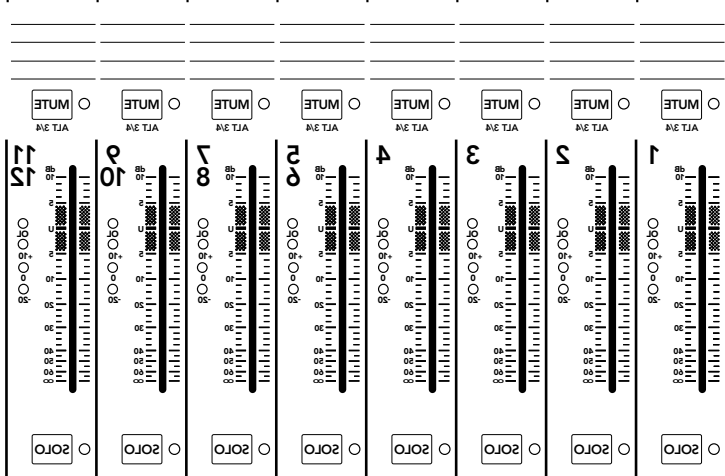
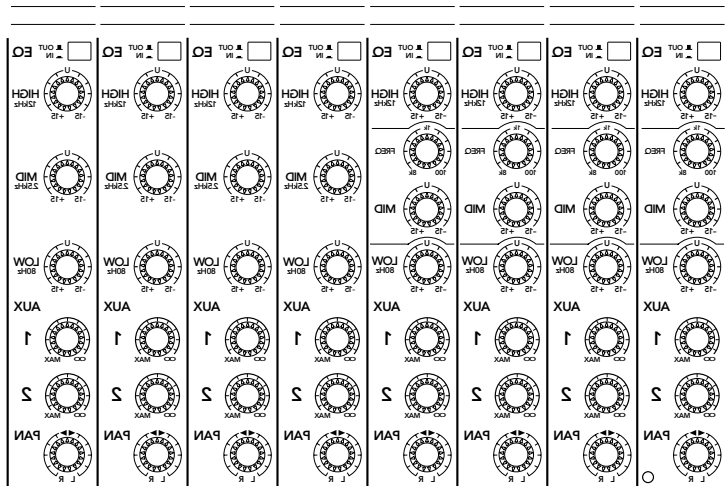
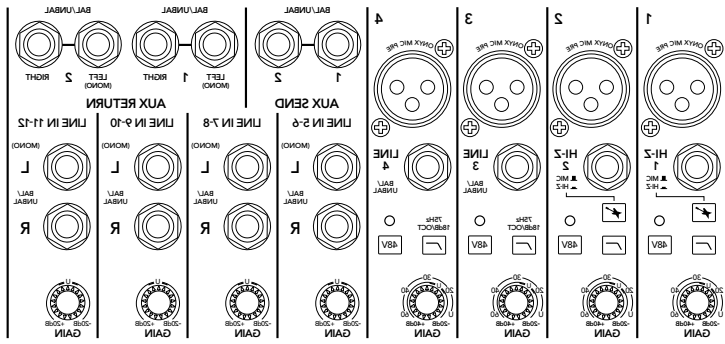
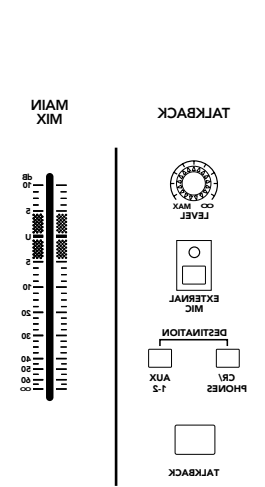
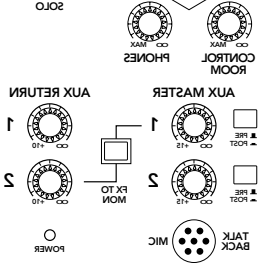
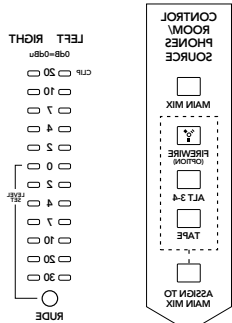
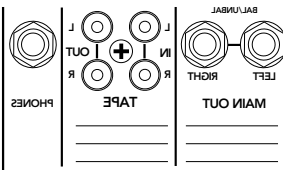

NOTES:

NOTES:

Onyx 1220 Limited Warranty

Please keep your sales receipt in a safe place.

A. LOUD Technologies Inc. warrants all materials, workmanship and proper operation of this product for a period of **three years** from the original date of purchase. If any defects are found in the materials or workmanship or if the product fails to function properly during the applicable warranty period, LOUD Technologies, at its option, will repair or replace the product. **This warranty applies only to equipment sold and delivered within the U.S. by LOUD Technologies Inc. or its authorized dealers.**

B. Failure to register online or return the product registration card will not void the three-year warranty.

C. Service and repairs of Mackie products are to be performed **only** at the factory (see D below) OR at an Authorized Mackie Service Center (see E below). Unauthorized service, repairs, or modification will void this warranty. To obtain repairs under warranty, you must have a copy of your sales receipt from the store where you bought the product. It is necessary to establish purchase date and thus determine whether or not your Mackie product is still under warranty.

D. To obtain factory service:

1. Call Mackie Service at 800/898-3211, 7 AM to 5 PM Monday through Friday (Pacific Time) to get a Return Authorization (RA). Products returned without an RA number will be refused.

2. Pack the product in its original shipping carton. If you do not have the carton, just ask for one when you get your RA number, and we'll send a shipping carton out promptly. More information on packing can be found in the *Service* section of this manual. Please seal the Mackie product in a plastic bag.

3. Also include a note explaining exactly how to duplicate the problem, a copy of the sales receipt with price and date showing, and your return street address (no P.O. boxes or route numbers, please!). If we cannot duplicate the problem or establish the starting date of your Limited Warranty, we may, at our option, charge for service time.

4. Ship the product in its original shipping carton, **freight prepaid** to:

MACKIE SERVICE DEPARTMENT
16220 Wood-Red Road NE
Woodinville, WA, 98072, USA

IMPORTANT: Make sure that the RA number is plainly written on the shipping carton.

E. To obtain service from an Authorized Mackie Service Center:

1. Call Mackie Service at 800/898-3211, 7 AM to 5 PM Monday through Friday (Pacific Time) to get: 1) The name and address of your nearest Authorized Mackie Service Center and 2) A return authorization (RA). You must have an RA number before taking your unit to a service center.

2. Make sure that you have a copy of your sales receipt from the store where you bought the product. If you can't find it, the Authorized Service Center may charge you for repairs even if your Mackie product is still covered by the Three-Year Limited Warranty.

3. Make sure that the problem can be duplicated. If you bring your Mackie product to an Authorized Service Center and they can't find anything wrong with it, you may be charged a service fee.

4. If the Authorized Mackie Service Center is located in another city, pack the mixer in its original shipping carton. More information on packing can be found in the *Service* section of this manual.

5. Contact the Authorized Mackie Service Center to arrange service or bring the Mackie product to them.

F. LOUD Technologies and Authorized Mackie Service Centers reserve the right to inspect any products that may be the subject of any warranty claims before repair or replacement is carried out. LOUD Technologies and Authorized Mackie Service Centers may, at their option, require proof of the original date of purchase in the form of a dated copy of the original dealer's invoice or sales receipt. Final determination of warranty coverage lies solely with LOUD Technologies or its Authorized Service Centers.

G. Mackie products returned to LOUD Technologies and deemed eligible for repair or replacement under the terms of this warranty will be repaired or replaced within thirty days of receipt by LOUD Technologies. LOUD Technologies may use refurbished parts for repair or replacement of any product. Products returned to LOUD Technologies that do not meet the terms of this Warranty will be repaired and returned C.O.D. with billing for labor, materials, return freight, and insurance. Products repaired under warranty at the factory will be returned freight prepaid by LOUD Technologies to any location within the boundaries of the USA.

H. LOUD Technologies warrants all repairs performed for 90 days or for the remainder of the warranty period. This warranty does not extend to damage resulting from improper installation, misuse, neglect or abuse, or to exterior appearance. This warranty is recognized only if the inspection seals and serial number on the unit have not been defaced or removed.

I. LOUD Technologies assumes no responsibility for the quality or timeliness of repairs performed by Authorized Mackie Service Centers.

J. This warranty is extended to the original purchaser and to anyone who may subsequently purchase this product within the applicable warranty period. A copy of the original sales receipt is required to obtain warranty repairs.

K. This is your sole warranty. LOUD Technologies does not authorize any third party, including any dealer or sales representative, to assume any liability on behalf of LOUD Technologies or to make any warranty for LOUD Technologies Inc.

L. THE WARRANTY GIVEN ON THIS PAGE IS THE SOLE WARRANTY GIVEN BY LOUD TECHNOLOGIES INC. AND IS IN LIEU OF ALL OTHER WARRANTIES, EXPRESS AND IMPLIED, INCLUDING THE WARRANTIES OF MERCHANTABILITY AND FITNESS FOR A PARTICULAR PURPOSE. THE WARRANTY GIVEN ON THIS PAGE SHALL BE STRICTLY LIMITED IN DURATION TO THREE YEARS FROM THE DATE OF ORIGINAL PURCHASE FROM AN AUTHORIZED MACKIE DEALER. UPON EXPIRATION OF THE APPLICABLE WARRANTY PERIOD, LOUD TECHNOLOGIES INC. SHALL HAVE NO FURTHER WARRANTY OBLIGATION OF ANY KIND. LOUD TECHNOLOGIES INC. SHALL NOT BE LIABLE FOR ANY INCIDENTAL, SPECIAL, OR CONSEQUENTIAL DAMAGES THAT MAY RESULT FROM ANY DEFECT IN THE MACKIE PRODUCT OR ANY WARRANTY CLAIM. Some states do not allow exclusion or limitation of incidental, special, or consequential damages or a limitation on how long warranties last, so some of the above limitations and exclusions may not apply to you. This warranty provides specific legal rights and you may have other rights which vary from state to state.

MACKIE®

16220 Wood-Red Road NE • Woodinville, WA 98072 • USA
United States and Canada: 800.898.3211
Europe, Asia, Central and South America: 425.487.4333
Middle East and Africa: 31.20.654.4000
Fax: 425.487.4337 • www.mackie.com
E-mail: sales@mackie.com

Free Manuals Download Website

<http://myh66.com>

<http://usermanuals.us>

<http://www.somanuals.com>

<http://www.4manuals.cc>

<http://www.manual-lib.com>

<http://www.404manual.com>

<http://www.luxmanual.com>

<http://aubethermostatmanual.com>

Golf course search by state

<http://golfingnear.com>

Email search by domain

<http://emailbydomain.com>

Auto manuals search

<http://auto.somanuals.com>

TV manuals search

<http://tv.somanuals.com>