

Sound Palette Series

■ Small size and a wealth of mounting options make the Mackie Industrial SP400 compact, medium power loudspeaker ideal for use in business music systems. When used together with the SP800S subwoofer as a three-way system, a unique internal filter circuit allows the SP400 to operate as a band-limited complement to the subwoofer. With the filter bypassed, the SP400 operates as a full bandwidth, stand-alone product. Speaker zones can be intermixed, adding additional low-frequency response wherever needed.

■ The woofer is a high-excursion, carbon fiber design. The high-frequency section is a horn loaded, high-efficiency dome tweeter featuring a Ferrofluid[®] cooled coil. Together they provide natural, smooth sound reproduction and high resistance to weather.

■ Installation of the SP400 is fast and efficient with two M6, two M10 threaded inserts and a wide variety of optional mounting brackets. Electrical connections are made to recessed color-coded, spring-loaded terminals. Wattage taps and voltage adjustments are selectable by means of two detented rotary switches. The enclosure is constructed of high-density, scratch-resistant polystyrene and includes a protective perforated steel grille and connection cover. It is available in black or white (SP400W) and may be painted to match existing environments.

■ The SP400 is a part of Mackie Industrial's Sound Palette series, integrated for business applications. Speakers include full range and a complementary low frequency system, designed for constant voltage parallel connection. Sound Palette controller-amplifiers provide complete, sophisticated control operations, optimized for business music systems.

■ This Mackie Industrial product is covered by an exclusive, one-time, NO FAULT repair policy in addition to a five year limited warranty.

Compact Two-Way Speaker



Features

- 5" carbon fiber, high excursion low-frequency transducer
- 120° x 100° horn loaded dome tweeter
- Exclusive Sound Palette band-limiting filter for sub-woofer integration anywhere on the constant voltage line
- Built-in externally adjustable, multi-tap constant voltage transformer
- Trapezoidal shaped enclosure for multiple applications and minimum visual intrusion
- Lightweight, UV/weather resistant, high density polystyrene
- Built-in threaded inserts for wide array of optional mounting hardware
- Exclusive Mackie Industrial — one time, NO FAULT repair policy
- Five year limited warranty

- Quality Foreground/Background Music
- Speech Reinforcement
- Multi-Zone Music and Paging
- Satellite or Full Range Applications

SP400 Compact Two-Way Speaker

Specifications

System

Freq. Range (-10 dB):	75Hz–21kHz
Freq. Response (-3 dB):	160Hz–18kHz
Horz. Coverage Angle (-6 dB):	120° averaged 800Hz to 16kHz
Vert. Coverage Angle (-6 dB):	100° averaged 800Hz to 16kHz
Directivity Factor; Q(DI):	5.6 (7.5) averaged 800Hz to 16kHz
System Sensitivity ¹ :	88dB, 1W @ 1m
Rated Maximum SPL:	109dB, @ 1m
System Input Power Rating ² :	30W RMS, 120W Peak
Constant Voltage:	70V, 100V
Power Taps:	1, 2, 4, 7.5, 15, 30W
Crossover:	4kHz
High Pass Filter:	150Hz, switchable
Impedance:	4Ω

Transducers

Low-Frequency:	5" (130mm) carbon fiber woofer
High-Frequency:	.5" (13mm) dome tweeter, ferrofluid cooled

Physical

Enclosure:	45° back angles, high density polystyrene
Attachment Inserts:	3 points M6 threaded, 2 points M10 threaded
Color:	Matte black, white (SP400W), scratch resistant paint
Grille:	Matching perforated steel grille
Input Connectors:	Push connector plate
Dimensions (HxWxD):	10.31" x 7.17" x 6.57" (262mm x 182mm x 167mm)
Net Weight:	6.6lb. (3kg)

Options

MA 3-5, MA 3-5W	Articulated surface mount hardware, black (W- white)
MA 5-6	Plate for suspending 4 clustered speakers, black
MA 5-7	Speaker tilt bracket for MA 5-6, black
MA 5-9, MA 5-9W	U-bracket, black (W- white)

¹ Measured on axis in the far field with 1 watt (2.00 V RMS, 4Ω) input and referenced to 1 meter distance using the inverse square law. Listed sound pressure represents an average from 300Hz to 3kHz.

² 20 Hz to 20 kHz continuous pink noise spectrum, Peak for 2 hours with +6 dB crest factor.

SP400 Compact Two-Way Speaker

SP400 Vertical Polars

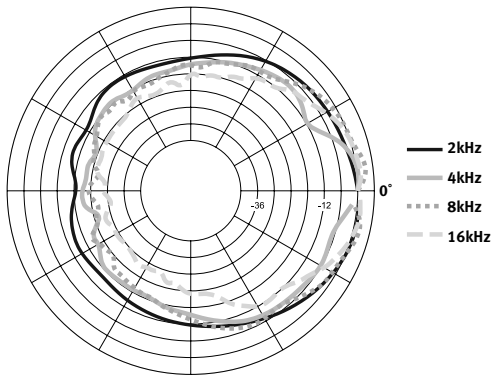
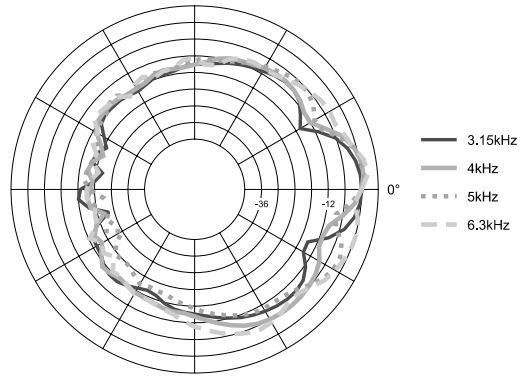
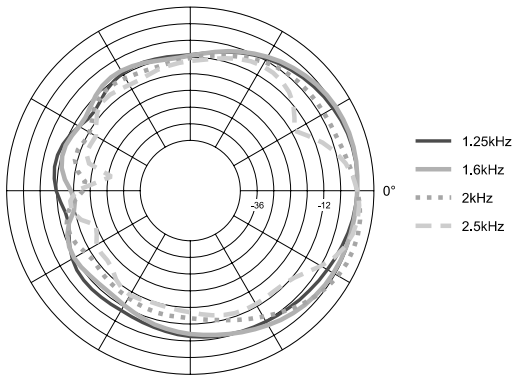
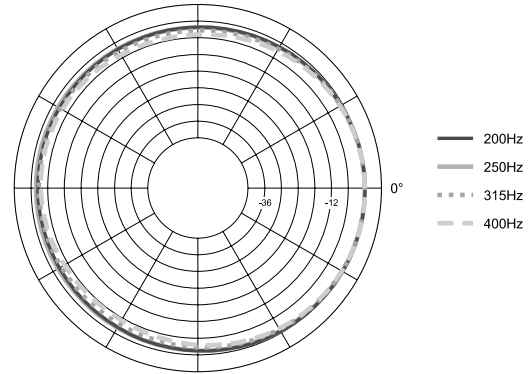
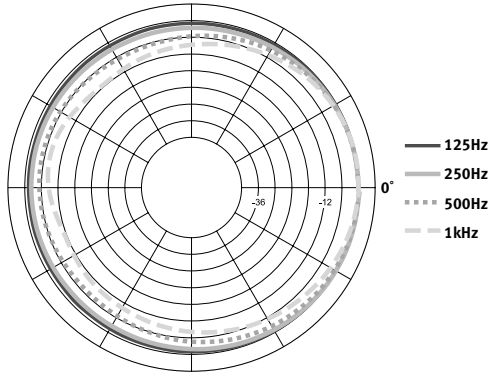

Vertical Off-Axis Frequency Response (up)

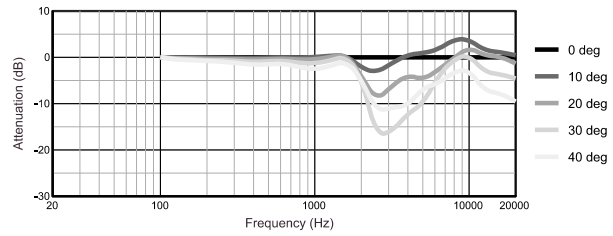

Vertical Off-Axis Frequency Response (down)

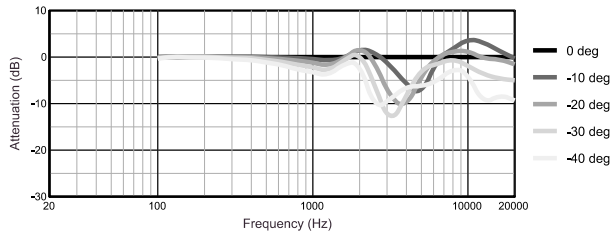

SP400
Horizontal Polars

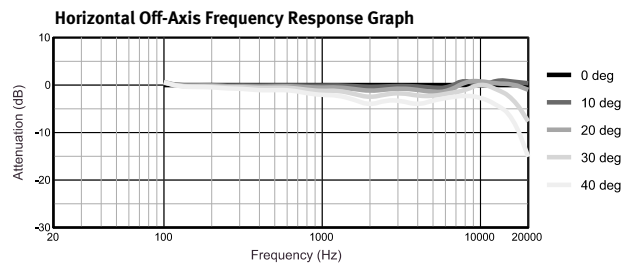
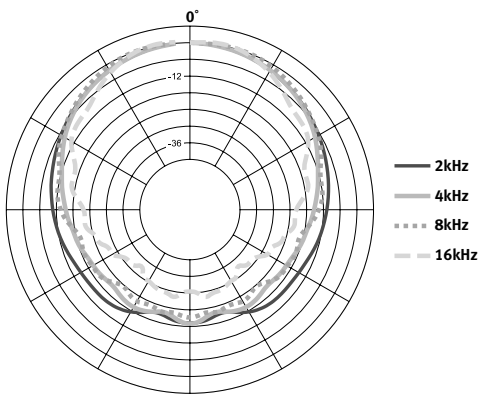
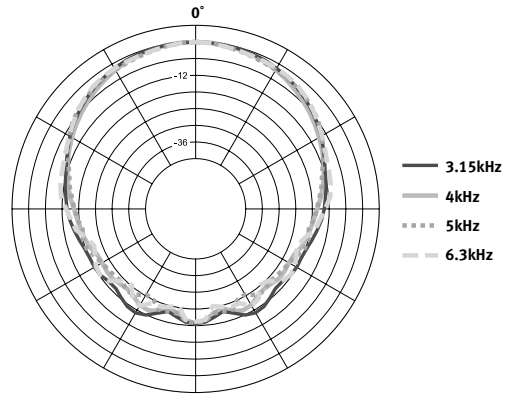
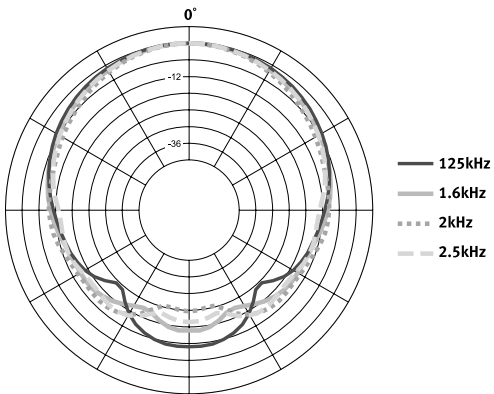
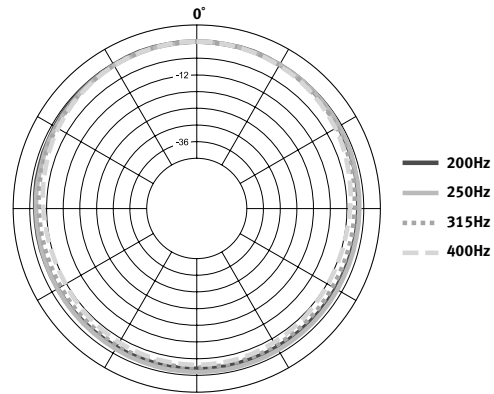
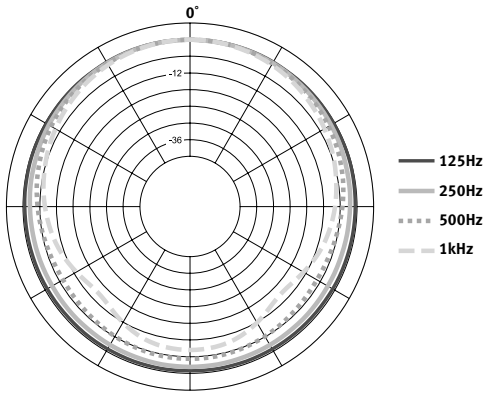

SP400 Compact Two-Way Speaker

Frequency response is measured on-axis at a distance referenced back to 1m at 1-watt drive. Shown as half-space (2π) environment.

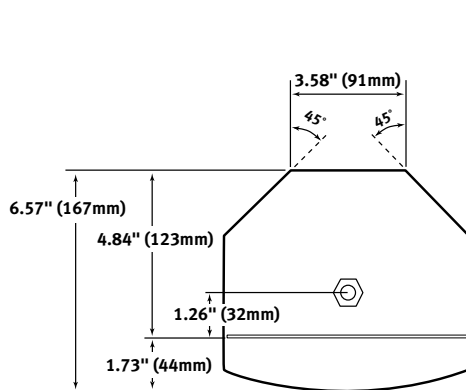
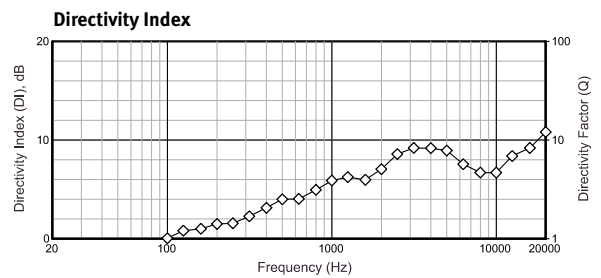
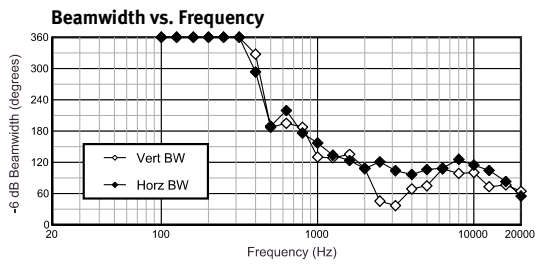
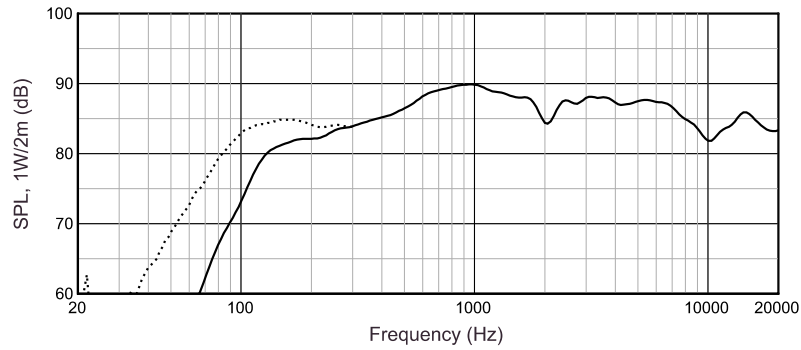

TOP

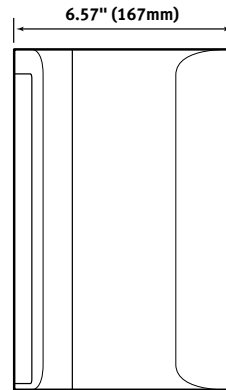

SIDE

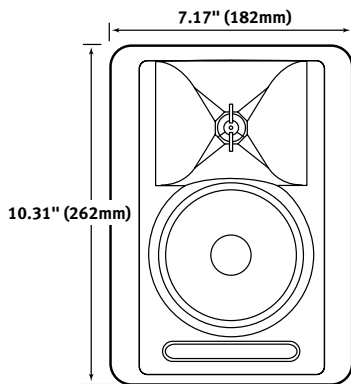

FRONT

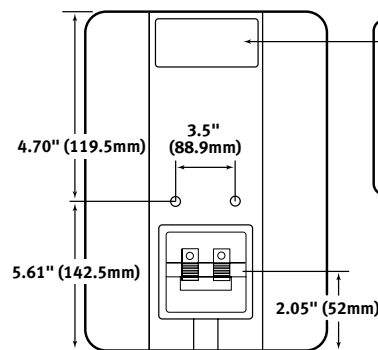

REAR

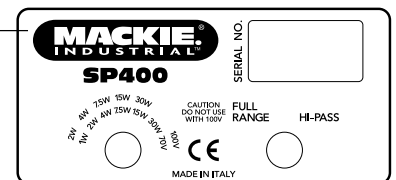

SP400 Compact Two-Way Speaker

Architects' and Engineers' Specifications

The two-way loudspeaker system shall be a self-contained unit, housed in a vented enclosure with protective grille and consisting of the following sub-systems: (1) a 5" (130mm) low-frequency, carbon-fiber cone driver, (2) a high-frequency, 120° x 100° constant directivity polynomial horn and horn-loaded, dome tweeter, (2) passive crossover network, (3) high-pass filter network, (3) integrated constant voltage line transformer.

The drivers shall be crossed over using a 4kHz LICC passive network and shall include a switchable 150Hz high-pass filter. The system shall be capable of producing 88dB SPL (1W @ 1m) sensitivity, 109dB peak (Max @ 1m) and shall handle 30W RMS continuous power over an operating frequency range of 160Hz to 18kHz.

The loudspeaker input shall be a selectable 70, 100V constant voltage or nominal 4Ω and provide a matching transformer with selectable power taps of 1, 2, 4, 7.5, 15, and 30W @ 70V/100V. Selections shall be made using a screwdriver accessible slotted switch. Loudspeaker connections shall be color polarized, binding post terminals.

The reinforced, high-density polypropylene enclosure shall be trapezoidal in shape, equipped with two M6 threaded inserts at the back and with two M10 threaded inserts at the ends for mounting hardware. Mounting hardware, designed as options for the unit, shall be available from the manufacturer. The loudspeaker system shall be model Sound Palette SP400 (black) or Sound Palette SP400W (white) manufactured by Mackie Industrial.



www.mackieindustrial.com

16220 Wood-Red Rd. NE, Woodinville, WA 98072 USA
888.337.7404, fax 425.487.4337, industrial@mackie.com

UK +44.1268.571.212, fax +44.1268.570.809, info@rcf-uk.com
ITALY +39.0522.354.111, fax +39.0522.926.208, industrial@rcf.it
FRANCE +33.3.8546.9160, fax +33.3.8546.9161, rcf.commercial@wanadoo.fr
GERMANY +49.2572.96042.0, fax +49.2572.96042.10, industrial@mackie.de

Electronic files for this product available at:
www.mackieindustrial.com

This Specification Sheet
Quick-Start Manual

SP400.PDF
SP400QS.PDF

Mackie Designs continually engages in research related to product improvement. New material, production methods, and design refinements are introduced into existing products without notice as a routine expression of that philosophy. For this reason, any current Mackie Industrial product may differ in some respect from its published description, but will always equal or exceed the original design specifications unless otherwise stated. ©1999-2001 Mackie Designs Inc. All rights Reserved. **MACKIE** and  are registered trademarks of Mackie Designs Inc. Mackie Industrial is a trademark of Mackie Designs Inc.

part no. 910-184/158-10 Rev.B

Free Manuals Download Website

<http://myh66.com>

<http://usermanuals.us>

<http://www.somanuals.com>

<http://www.4manuals.cc>

<http://www.manual-lib.com>

<http://www.404manual.com>

<http://www.luxmanual.com>

<http://aubethermostatmanual.com>

Golf course search by state

<http://golfingnear.com>

Email search by domain

<http://emailbydomain.com>

Auto manuals search

<http://auto.somanuals.com>

TV manuals search

<http://tv.somanuals.com>