

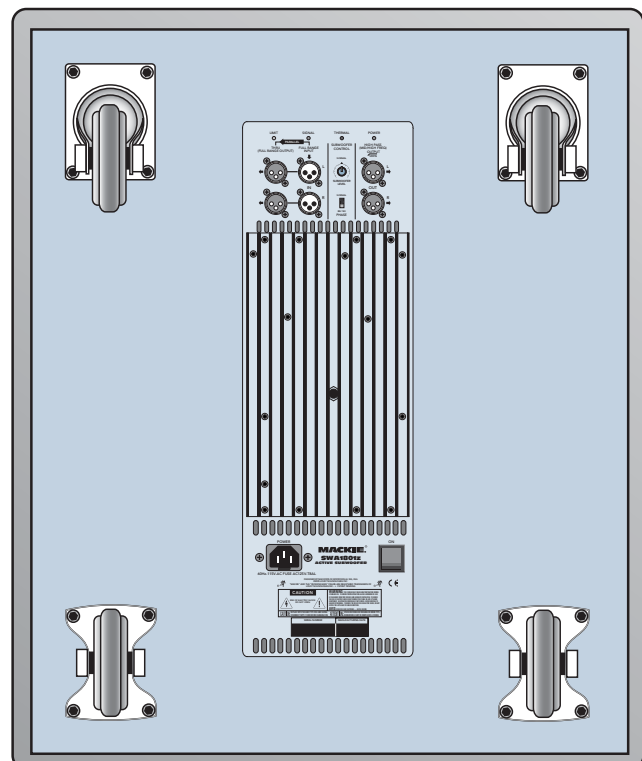

[®]
MACKIE

SWA1801z ACTIVE SUBWOOFER SYSTEM USER'S MANUAL

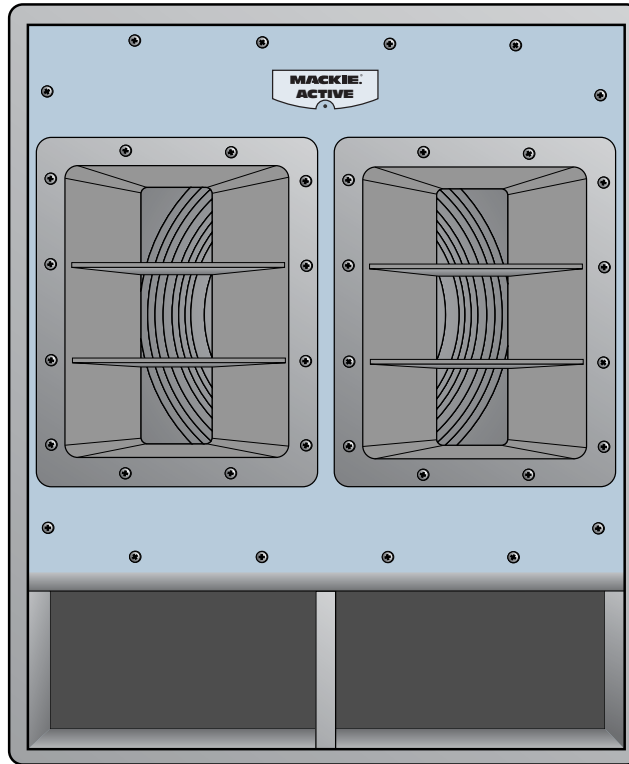

 <div style="background-color: black; color: white; padding: 5px; font-weight: bold; font-size: 1.2em;">CAUTION AVIS</div> <div style="text-align: center;"> <p>RISK OF ELECTRIC SHOCK DO NOT OPEN</p> <p>RISQUE DE CHOC ELECTRIQUE NE PAS OUVRIR</p> </div> 
<p>CAUTION: TO REDUCE THE RISK OF ELECTRIC SHOCK DO NOT REMOVE COVER (OR BACK) NO USER-SERVICEABLE PARTS INSIDE REFER SERVICING TO QUALIFIED PERSONNEL</p> <p>ATTENTION: POUR EVITER LES RISQUES DE CHOC ELECTRIQUE, NE PAS ENLEVER LE COUVERCLE. AUCUN ENTRETIEN DE PIECES INTERIEURES PAR L'USAGER. CONFIER L'ENTRETIEN AU PERSONNEL QUALIFIE.</p> <p>AVIS: POUR EVITER LES RISQUES D'INCENDIE OU D'ELECTROCUTION, N'EXPOSEZ PAS CET ARTICLE A LA PLUIE OU A L'HUMIDITE</p>



The lightning flash with arrowhead symbol within an equilateral triangle is intended to alert the user to the presence of uninsulated "dangerous voltage" within the product's enclosure that may be of sufficient magnitude to constitute a risk of electric shock to persons.

Le symbole éclair avec point de flèche à l'intérieur d'un triangle équilatéral est utilisé pour alerter l'utilisateur de la présence à l'intérieur du coffret de "voltage dangereux" non isolé d'ampleur suffisante pour constituer un risque d'électrocution.



The exclamation point within an equilateral triangle is intended to alert the user of the presence of important operating and maintenance (servicing) instructions in the literature accompanying the appliance.

Le point d'exclamation à l'intérieur d'un triangle équilatéral est employé pour alerter les utilisateurs de la présence d'instructions importantes pour le fonctionnement et l'entretien (service) dans le livret d'instruction accompagnant l'appareil.

SAFETY INSTRUCTIONS

- 1. Read Instructions** — All the safety and operation instructions should be read before this Mackie product is operated.
- 2. Retain Instructions** — The safety and operating instructions should be kept for future reference.
- 3. Heed Warnings** — All warnings on this Mackie product and in these operating instructions should be followed.
- 4. Follow Instructions** — All operating and other instructions should be followed.
- 5. Water and Moisture** — This Mackie product should not be used near water — for example, near a bathtub, washbowl, kitchen sink, laundry tub, in a wet basement, near a swimming pool, swamp or salivating St. Bernard dog, etc.
- 6. Cleaning** — Clean only with a dry cloth.
- 7. Ventilation** — This Mackie product should be situated so that its location or position does not interfere with its proper ventilation. For example, the Component should not be situated on a bed, sofa, rug, or similar surface that may block any ventilation openings, or placed in a built-in installation such as a bookcase or cabinet that may impede the flow of air through ventilation openings.
- 8. Heat** — This Mackie product should be situated away from heat sources such as radiators, or other devices which produce heat.

WARNING: The heat sink may reach high temperatures during standard use. To ensure proper operation, allow a minimum of six inches of clearance from the heat sink surface and adequate ventilation.

9. Power Sources — This Mackie product should be connected to a power supply only of the type described in these operation instructions or as marked on this Mackie product.

10. Power Cord Protection — Power supply cords should be routed so that they are not likely to be walked upon or pinched by items placed upon or against them, paying particular attention to cords at plugs, convenience receptacles, and the point where they exit this Mackie product.

11. Object and Liquid Entry — Care should be taken so that objects do not fall on, and liquids are not spilled into, this Mackie product.

12. Damage Requiring Service — This Mackie product should be serviced only by qualified service personnel when:

- The power-supply cord or the plug has been damaged; or
- Objects have fallen, or liquid has spilled into this Mackie product; or
- This Mackie product has been exposed to rain; or
- This Mackie product does not appear to operate normally or exhibits a marked change in performance; or
- This Mackie product has been dropped, or its chassis damaged.

13. Servicing — The user should not attempt to service this Mackie product beyond those means described in this operating manual. All other servicing should be referred to the Mackie Service Department.

14. To prevent electric shock, do not use this polarized plug with an extension cord, receptacle or other outlet unless the blades can be fully inserted to prevent blade exposure.

Pour prévenir les chocs électriques ne pas utiliser cette fiche polarisée avec un prolongateur, un prise de courant ou une autre sortie de courant, sauf si les lames peuvent être insérées à fond sans laisser aucune partie à découvert.

15. Grounding or Polarization — Precautions should be taken so that the grounding or polarization means of this Mackie product is not defeated.

16. Power Precaution — Unplug this Mackie product during lightning storms or when unused for long periods of time. Note that this Mackie product is not completely disconnected from the AC mains service when the power switch is in the OFF position.

17. This apparatus does not exceed the Class A/Class B (whichever is applicable) limits for radio noise emissions from digital apparatus as set out in the radio interference regulations of the Canadian Department of Communications.

ATTENTION — Le présent appareil numérique n'émet pas de bruits radioélectriques dépassant les limites applicables aux appareils numériques de class A/de class B (selon le cas) prescrites dans le règlement sur le brouillage radioélectrique édicté par les ministere des communications du Canada.

WARNING — To reduce the risk of fire or electric shock, do not expose this appliance to rain or moisture.

WARNING — The cabinet has no rigging points and is not suitable for flying. Never attempt to suspend the cabinet by its handles.



Lend Me Your Ears

Exposure to extremely high noise levels may cause permanent hearing loss. Individuals vary considerably in susceptibility to noise-induced hearing loss, but nearly everyone will lose some hearing if exposed to sufficiently intense noise for a period of time.

The U.S. Government's Occupational Safety and Health Administration (OSHA) has specified the permissible noise level exposures shown in this chart.

According to OSHA, any exposure in excess of these permissible limits could result in some hearing loss. To ensure against potentially dangerous exposure to high sound-pressure levels, it is recommended that all persons exposed to equipment capable of producing these levels use hearing protectors while this unit is in operation. Ear plugs or protectors in the ear canals or over the ears must be worn when operating this amplification system in order to prevent a permanent hearing loss if exposure is in excess of the limits set forth here.

Duration Per Day In Hours	Sound Level dBA, Slow Response	Typical Example
8	90	Duo in small club
6	92	
4	95	Subway Train
3	97	
2	100	Very loud classical music
1.5	102	
1	105	Patrice screaming at Ron about deadlines
0.5	110	
0.25 or less	115	Loudest parts at a rock concert



The SWA1801z can produce a maximum SPL of 135 dB @ 1m

CONTENTS	
Lend Me Your Ears	3
INTRODUCTION.....	3
REAR PANEL DESCRIPTION.....	4
HOOKUP DIAGRAMS.....	5
CONNECTIONS.....	6
PLACEMENT.....	6
AC POWER	7
THERMAL CONSIDERATIONS.....	7
SERVICE INFORMATION.....	7
Warranty Service	7
Troubleshooting	7
Repair	9
SWA1801z SPECIFICATIONS	10
SWA1801z LIMITED WARRANTY	11

INTRODUCTION

Thank you for choosing Mackie's active sound reinforcement speaker systems.

The SWA1801z is a high-output active subwoofer system. It features a high-precision 18" transducer combined with application-specific amplifier technology. The system is composed of a single, compact subwoofer cabinet with built-in control and amplifier electronics.

Connecting and setting up the SWA1801z is a breeze. It accepts a stereo or mono line-level signal via female XLR input jacks. Male XLR Thru jacks are provided for daisy-chaining the signal to additional SWA1801z cabinets. The built-in crossover separates the low frequencies from the high frequencies, and routes the high frequencies to the male XLR high-pass output jacks. Connect these to the inputs of full-range active speakers such as the Mackie SA1521z, or to an amplifier powering a pair of passive speakers such as a combination of the Mackie

M•1400i and C300z. A Phase switch gives you the option of reversing the polarity of the signal to the subwoofer by 180°. A Subwoofer Level control allows you to adjust the balance between the subwoofer and the full-range speakers.

The built-in amplifier produces 800 watts of continuous power. The amplifier module sits on a heatsink that eliminates the need for fans, dramatically extending life expectancy, and eliminating maintenance cycles. A tremendous benefit of having the amplifier located within the subwoofer cabinet is that the SWA1801z functions as a system, optimizing acoustic, electronic, and mechanical designs to achieve the highest level of performance and value.

The cabinet is constructed with 15 mm thick multi-layered birch plywood. Carrying handles are integrated into each side for easy loading, and casters are attached to the rear for easy transport.

Don't forget to visit our website at www.mackie.com for more information about this and other Mackie products.



REAR PANEL DESCRIPTION

1 POWER Switch

Use this switch to turn the SWA1801z on and off. Make sure the signal source's level control is turned down before you turn it on.

2 AC Receptacle

This is where you connect the AC linecord to provide AC power to the SWA1801z's built-in power amplifiers. Plug the linecord into an AC socket properly configured for your particular model.

3 LIMIT Indicator

The SWA1801z has a built-in limiter that prevents the amplifier outputs from overdriving the transducers. The LIMIT indicator lights when the limiter is activated. It's okay for the LIMIT indicator to blink occasionally, but if it blinks frequently or lights continuously, turn down the level control until the LIMIT indicator only blinks occasionally.

4 SIGNAL Present Indicator

This LED illuminates whenever there is a signal present at the FULL RANGE INPUT connector on the rear panel.

5 THERMAL Indicator

The SWA1801z has a thermal protection circuit that monitors the internal temperature of the amplifiers and heatsink. If the internal temperature should exceed a safe operating level, this indicator lights and the signal is muted to allow the amplifier to cool. When the temperature cools to a safe level once again, the thermal protection circuit deactivates and normal operation resumes.

Note: Activation of the thermal protection circuit is an indication that you should take steps to avoid continued thermal problems. See "Thermal Considerations" on page 7.

6 POWER Indicator

When the POWER switch is turned on and the linecord is connected to an active AC power supply, this indicator lights green to let you know that you're ready to rock and roll. The cool blue LED on the front of the cabinet works in the same way.

7 FULL RANGE INPUT

These are female XLR-type connectors that accept a balanced line-level signal from a mixing console or other signal source.

8 THRU (FULL RANGE OUTPUT)

These are male XLR-type connectors that produce exactly the same signal that is connected to the FULL RANGE INPUT jack. Use it to daisy-chain several SWA1801z's together off the same signal source.

9 HIGH PASS (MID/HIGH FREQ) OUTPUT

These are male XLR-type connectors that produce the frequencies above 120Hz. Connect these to a pair of full-range active speakers or to an amplifier/passive speaker combination. The SWA1801z reproduces the frequencies below 120Hz.

10 SUBWOOFER LEVEL Control

This adjusts the subwoofer level. The center detent position provides 15 dB of headroom with a nominal +4 dBu input signal. Use this as a starting point for setting the balance between the subwoofer and the main speakers.

11 PHASE

This switch reverses the polarity of the subwoofer output. Depending on the placement of the SWA1801z subwoofer relative to the full-range speakers, you may get a better low-frequency response in the room if you reverse the polarity of the subwoofer's signal. Experiment with this switch to determine which position sounds best.

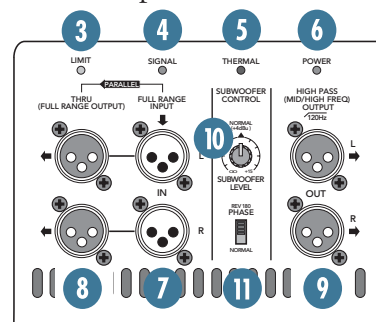
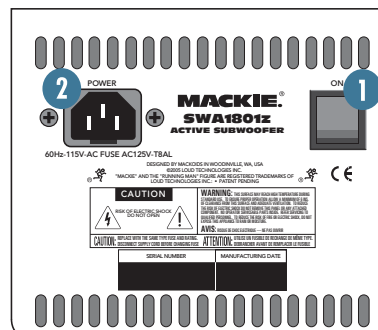

HOOKUP DIAGRAMS

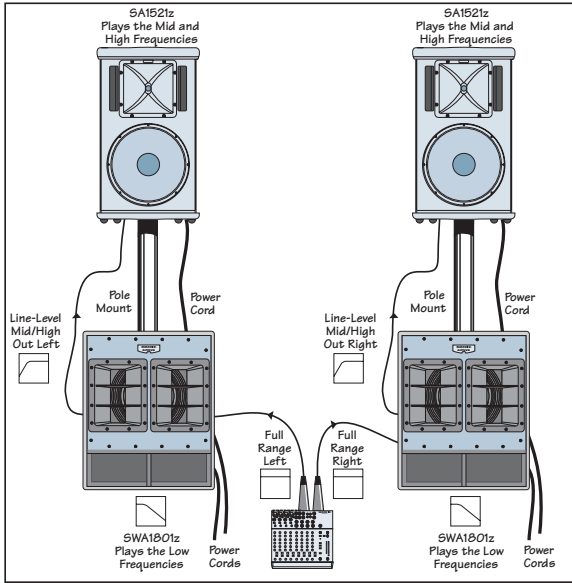

2 SWA1801z WITH 2 SA1521z

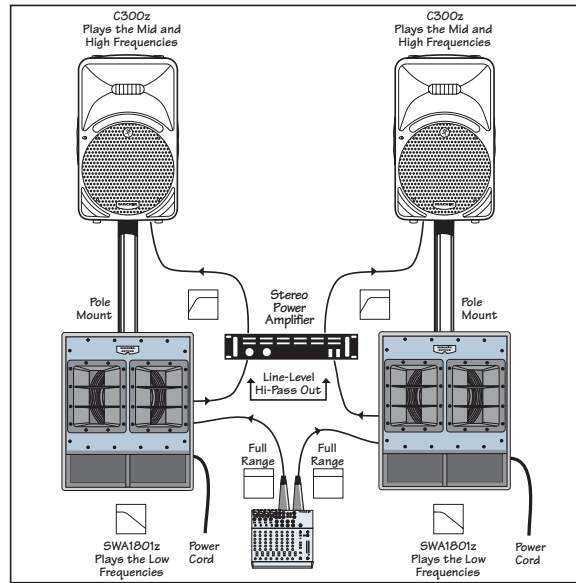

2 SWA1801z WITH STEREO AMPLIFIER AND 2 C300z

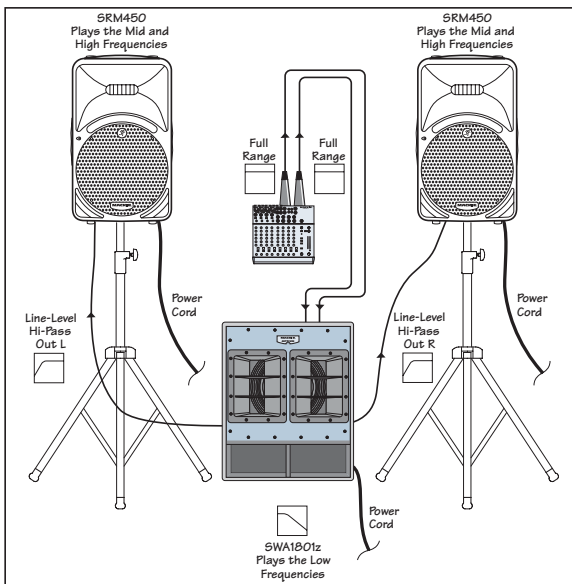

1 SWA1801z WITH 2 SRM450s

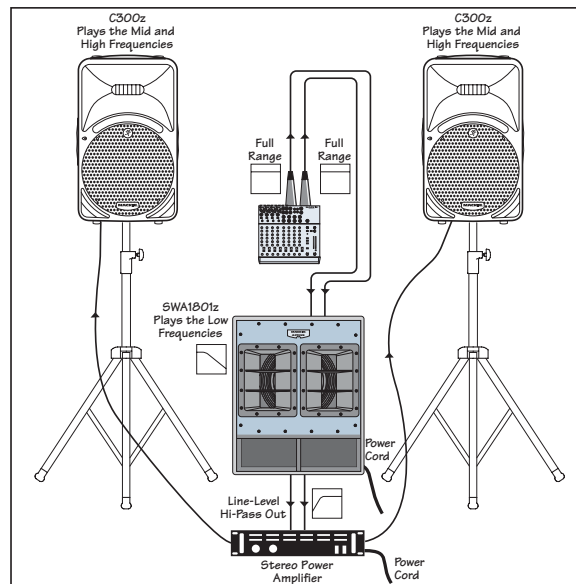

1 SWA1801z WITH STEREO AMPLIFIER AND 2 C300z

CONNECTIONS

The SWA1801z has two female XLR inputs that accept a balanced line-level signal. When connecting a balanced signal, be sure it's wired per AES (Audio Engineering Society) standards:

XLR	
Hot (+)	Pin 2
Cold (-)	Pin 3
Shield (Ground)	Pin 1

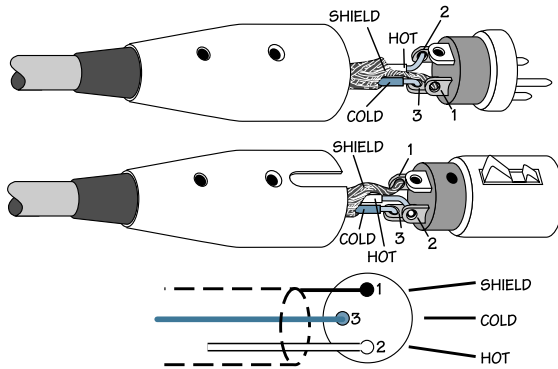

Balanced XLR Connectors

If connecting an unbalanced signal to the SWA1801z balanced input, be sure that the signal high (hot) connection is wired to Pin 2 and the unbalanced ground connection is wired to the low *and* the ground connections of the balanced input (Pins 3 and 1). If there are ground-loop problems, try connecting the unbalanced ground connection only to the input low connection (Pin 3), and leaving the input ground connection disconnected.

There are also four male XLR connectors labeled THRU (FULL RANGE OUTPUT) and HIGH PASS (MID/HIGH FREQ) OUTPUT. These are also wired according to the AES standard.

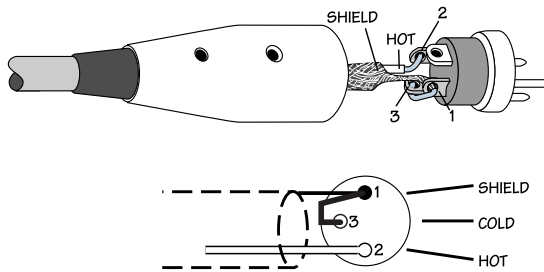

Unbalanced Male XLR Connector

The THRU output connectors allow you to connect more than one SWA1801z to your system. Simply plug the signal source (i.e., mixer output) into the first speaker's FULL RANGE INPUT jacks, and patch that speaker's THRU jacks to the next speaker's INPUT jacks, and so on, daisy-chaining multiple speakers.

The THRU jack is wired straight from the FULL RANGE INPUT connector — there is no electronic circuitry between — so the signal coming out of the THRU jack is exactly the same as the signal going in.

The HIGH PASS OUTPUT jacks provide a line-level signal of the frequencies above 120Hz that you connect to a pair of active speakers (or to a stereo amplifier powering a pair of passive speakers).

PLACEMENT

The SWA1801z subwoofer is designed to sit on the floor. A socket is provided on the top of the SWA1801z for mounting the Mackie SA1521z or SRM450 active speakers. Use the optional Mackie speaker mounting pole (SPM100) to mount them on the SWA1801z (see Hookup Diagram on page 5).



As with any powered components, protect the SWA1801z from exposure to moisture. If you are setting them up outdoors, make sure they are under cover if you expect rain.



WARNING: The cabinet has no rigging points and is not suitable for rigging. **NEVER** attempt to suspend the SWA1801z by its handles.

AC POWER

Be sure the SWA1801z is plugged into an outlet that is able to supply the correct voltage specified for your model. If the voltage should drop below 97% of the specified line voltage, the built-in amplifiers will no longer be able to supply rated power. (They will continue to operate down to 80% of the rated line voltage, but won't reach full power, resulting in lower headroom.)

Be sure the electrical service can supply enough amperage for all the components connected to it.

We recommend that a stiff (robust) supply of AC power be used because the amplifiers place high current demands on the AC line. The more power that is available on the line, the louder the speakers will play and the more peak output power will be available for cleaner, punchier bass. A suspected problem of "poor bass performance" is often caused by a weak AC supply to the amplifiers.



Never remove the ground pin on the power cord of the SWA1801z or any other component. This is very dangerous.

THERMAL CONSIDERATIONS

The SWA1801z has a powerful 800 watt amplifier built-in. As amplifiers produce heat, it is important to dissipate the heat as quickly as possible. This results in increased reliability and longevity for the amplifier.

The amplifier module is mounted on a large heatsink, which is cooled by convection where cool air is drawn through it's fins, carrying the heat away. In order for this convection cooling to work efficiently, it is important to provide adequate airspace behind the loudspeaker. When you position the SWA1801z, we recommend leaving at least six inches of air space behind it.

In the unlikely event of the amplifier overheating, a built-in thermal switch will activate, which mutes the signal. When the amplifier has cooled down to a safe operating temperature, the thermal switch resets itself, and the SWA1801z resumes normal operation.

If the thermal switch activates frequently, try turning down the level control a notch or two on the mixing console (or other signal source) or on the subwoofer itself to avoid overheating the amplifiers.

If the temperature in the room is too high, it could cause the amplifier to overheat. In this case, you should try aiming a fan at the rear panel to move more air across the heatsink panel.

SERVICE INFORMATION

Warranty Service

Details concerning warranty service are spelled out on page 11 of this manual.

If you think your subwoofer has a problem, please do everything you can to confirm it before calling for service, including reading through the following Troubleshooting section. Doing so might save you from being deprived of your Mackie loudspeaker.

Of all Mackie products returned for service (which is hardly any at all), many are coded "CND" — Could Not Duplicate— which usually means the problem lay somewhere else in the system. The following troubleshooting tips may sound obvious, but here are some things you can check:

Troubleshooting

No power

- Our favorite question: Is it plugged in? Make sure the AC outlet is live (check with a tester or lamp).
- Our next favorite question: Is the POWER switch on? If not, try turning it on.
- Is the POWER LED on the rear panel glowing green? If not, make sure the AC outlet is live. If so, refer to "No sound" next.
- The internal AC line fuse may be blown. This is not a user serviceable part. If you suspect the AC line fuse is blown, please see the "Repair" section on page 9.

No sound

- Is the input LEVEL control for the input source or the subwoofer turned all the way down? Verify that all the volume controls in the system are properly adjusted.
- Is the signal source working (and making union scale)? Make sure the connecting cables are in good repair and securely connected at both ends. Make sure the output volume (gain) control on the mixing console is turned up sufficiently to drive the inputs of the speaker.
- Make sure the mixer does not have a Mute on or a Processor loop engaged. If you find something like this, make sure the volume/gain is turned down before disengaging the offending switch.
- Is the thermal protection circuit activated? Make sure there is at least six inches of free space behind the SWA1801z.

Poor bass performance

- Check the polarity of the connections between the mixer and the loudspeakers. You may have your positive and negative connections reversed at one end of one cable, causing one loudspeaker to be out-of-phase.
- Try switching the PHASE switch on the rear panel. This affects the polarity between the full-range speakers and the SWA1801z and may improve the low-frequency response.

Poor sound

- Is it loud and distorted? Make sure that you're not overdriving a stage in the signal chain. Verify that all level controls are set properly.
- Is the input connector plugged completely into the jack? Be sure all connections are secure. It's a good idea to periodically clean all electrical connections with a non-lubricating electrical contact cleaner.

Noise

- Make sure all connections to the active loudspeakers are good and sound.
- Make sure none of the signal cables are routed near AC cables, power transformers, or other EMI-inducing devices.
- Is there a light dimmer or other SCR-based device on the same AC circuit as the SWA1801z? Use an AC line filter or plug the SWA1801z into a different AC circuit.

Hum

- Try disconnecting the cable connected to the INPUT jack. If the noise disappears, it could be a "ground loop," rather than a problem with the SWA1801z. Try some of the following troubleshooting ideas:
 - Use balanced connections throughout your system for the best noise rejection.
 - Whenever possible, plug all the audio equipment's linecords into outlets which share a common ground. The distance between the outlets and the common ground should be as short as possible.

Repair

Service for Mackie products is available at a factory-authorized service center. Service for Mackie products living outside the United States can be obtained through local dealers or distributors.

If your SWA1801z needs service, please follow these instructions:

1. Review the preceding troubleshooting suggestions. Please.
2. Call Tech Support at 1-800-898-3211, 7am to 5pm PST, to explain the problem in detail. They will ask you all sorts of impertinent questions in the hope of sorting out the problem. If it appears that the SWA1801z needs repair, request a Service Request Number. Have your subwoofer's serial number ready. **You must have a Service Request Number before you can obtain factory-authorized service.**
3. Keep this user's manual. We don't need it to repair the subwoofer.
4. Pack the subwoofer in its original packaging, including protective wrap, endcaps, and box. This is **VERY IMPORTANT**. When you call for the Service Request Number, please let Tech Support know if you need new packaging. Mackie is not responsible for any damage that occurs due to non-factory packaging.
5. Include a legible note stating your name, shipping address (no P.O. boxes), daytime phone number, RA number, and a detailed description of the problem, including how we can duplicate it.
6. Write the Service Request Number in **BIG PRINT** on top of the box.
7. Tech Support will tell you where to ship the subwoofer for repair. We suggest insurance for all forms of cartage.
8. You will need to contact the authorized service center for their current turn-around times. The SWA1801z must be packaged in its original packing box, and must have the Service Request Number on the box. Once it is repaired, the authorized service center will ship it back by ground shipping, pre-paid (for warranty repairs).

Note: Under the terms of the warranty, you must ship or drop-off the unit to an authorized service center. The return ground shipment is covered for those deemed by us to be under warranty.

Note: You must have a sales receipt from an Authorized Mackie Dealer to qualify for a warranty repair.

Need Help?

You can reach a technical support representative
Monday through Friday
from 7 AM to 5 PM PST at:
1-800-898-3211

After hours, visit www.mackie.com and click Support,
or email us at: techmail@mackie.com



SWA1801z SPECIFICATIONS

System Specifications

Frequency Range (-10 dB)	35 Hz-120 Hz
Frequency Response (-3 dB)	45 Hz-120 Hz
Maximum SPL @ 1m	129 dB
Peak Output @ 1m	135 dB
Crossover Frequency	120 Hz (12 dB/octave)
Input Type	Balanced differential
Input Impedance	50 kΩ
Input Protection	Level protected
Thermal Protection	Input stage muting, auto-reset

Transducer Specifications

Low-Frequency Transducer

Diameter	18" (457 mm)
Voice Coil Diameter	4.0" (102 mm)

Power Amplifier

Low-Frequency Power Amplifier

Rated Power*	800 Watts continuous 1000 Watts peak
Rated THD	< 0.03 %
Cooling	Passive

Line Input Power

US	120 V, 60 Hz
Europe	230 V, 50 Hz

* Rated power into loudspeaker's rated impedance.

Physical Properties

Height	28.5" (724 mm)
Width	23.5" (597 mm)
Depth	23.5" (597 mm)
Weight	132 lbs. (60 kg)
Enclosure	15 mm thick multi-layered baltic birch wood

Enclosure Geometry

Rectangular

Mounting Methods

Floor mount only

WARNING: The cabinet has no rigging points and is not suitable for rigging. **NEVER** attempt to suspend the SWA1801z by its handles.

Disclaimer

Since we are always striving to make our products better by incorporating new and improved materials, components, and manufacturing methods, we reserve the right to change these specifications at any time without notice.

"Mackie" and the "Running Man" figure are registered trademarks of LOUD Technologies Inc.

All other brand names mentioned are trademarks or registered trademarks of their respective holders, and are hereby acknowledged.

©2005 LOUD Technologies Inc.
All Rights Reserved.

Dimensions

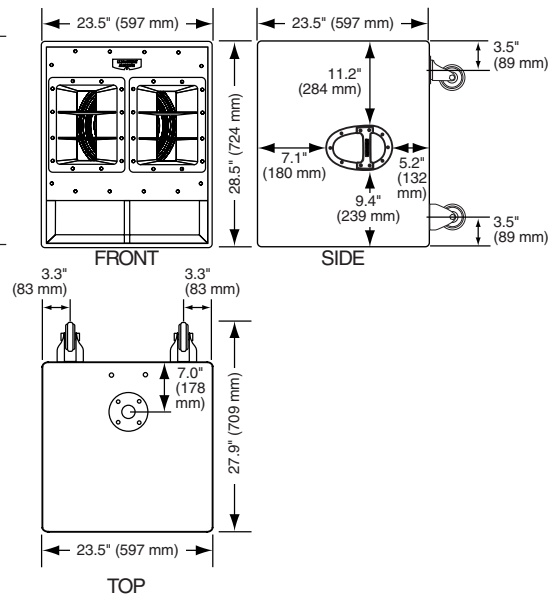

SWA1801z On Axis Frequency Response (with second and third harmonic components)

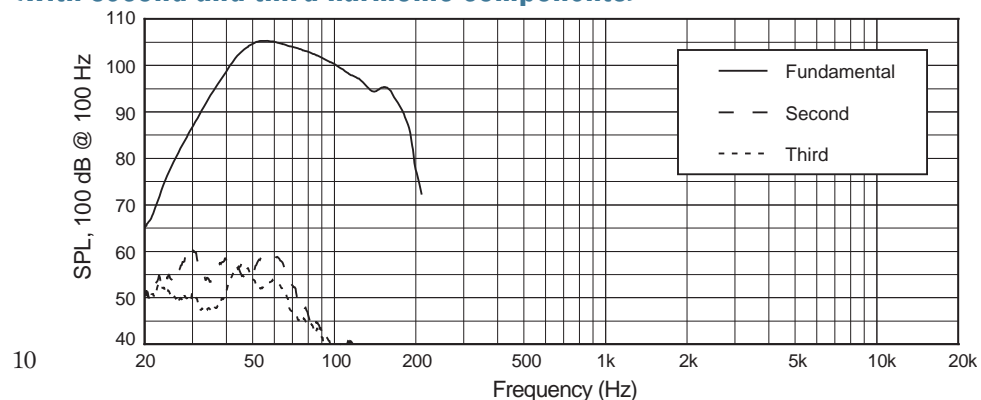

MACKIE®

SWA1801z LIMITED WARRANTY

Please keep your sales receipt in a safe place.

A. LOUD Technologies Inc. warrants all materials, workmanship and proper operation of this Mackie SWA1801z for a period of **five years** from the original date of purchase, with the following exception: warranty on all its loudspeaker components including woofers and compression drivers are only warranted for two years. If any defects are found in the materials or workmanship or if the product fails to function properly during the applicable warranty period, LOUD Technologies, at its option, will repair or replace the product. **This warranty applies only to equipment sold and delivered within the U.S. by LOUD Technologies Inc. or its authorized dealers.**

B. Failure to register online or return the product registration card will not void the five-year warranty.

C. Service and repairs of Mackie products are to be performed **only** at a factory-authorized facility (see D below). Unauthorized service, repairs, or modifications will void this warranty. To obtain repairs under warranty, you must have a copy of your sales receipt from the authorized Mackie dealer where you purchased the product. It is necessary to establish the purchase date and determine whether you Mackie product is within the warranty period.

D. To obtain factory-authorized service:

1. Call Mackie Technical Support at **800/898-3211**, 7 am to 5 pm Monday through Friday (Pacific Time) to get a Service Request Number. Products returned without a Service Request Number will be refused.

2. Pack the product in its original shipping carton. Also include a note explaining exactly how to duplicate the problem, a copy of the sales receipt with price and date showing, and your return street address (no P.O. boxes or route numbers, please!). If we cannot duplicate the problem or establish the starting date of your Limited Warranty, we may, at our option, charge for service time.

3. Ship the product in its original shipping carton, **freight prepaid** to the authorized service center. The address of the closest authorized service center will be given to you by Technical Support.

IMPORTANT: Make sure that the Service Request Number is plainly written on the shipping carton.

E. LOUD Technologies reserves the right to inspect any products that may be the subject of any warranty claims before repair or replacement is carried out. LOUD Technologies may, at our option, require proof of the original date of purchase in the form of a dated copy of the original dealer's invoice or sales receipt. Final determination of warranty coverage lies solely with LOUD Technologies.

F. Any products returned to one of LOUD Technologies factory-authorized service centers, and deemed eligible for repair or replacement under the terms of this warranty, will be repaired or replaced within thirty days of receipt by LOUD Technologies. LOUD Technologies and its authorized service centers may use refurbished parts for repair or replacement of any product. Products returned to LOUD Technologies that do not meet the terms of this Warranty will not be repaired unless payment is received for labor, materials, return freight, and insurance. Products repaired under warranty will be returned freight prepaid by LOUD Technologies to any location within the boundaries of the USA.

G. LOUD Technologies warrants all repairs performed on Mackie products for 90 days or for the remainder of the original warranty period. This warranty does not extend to damage resulting from improper installation, misuse, neglect or abuse, or to exterior appearance. This warranty is recognized only if the inspection seals and serial number on the unit have not been defaced or removed.

H. LOUD Technologies assumes no responsibility for the quality or timeliness of repairs performed by an authorized service center.

I. This warranty is extended to the original purchaser and to anyone who may subsequently purchase this product within the applicable warranty period. A copy of the original sales receipt is required to obtain warranty service.

J. This is your sole warranty. LOUD Technologies does not authorize any third party, including any dealer or sales representative, to assume any liability on behalf of LOUD Technologies or to make any warranty for LOUD Technologies.

K. THE WARRANTY GIVEN ON THIS PAGE IS THE SOLE WARRANTY GIVEN BY LOUD TECHNOLOGIES INC. AND IS IN LIEU OF ALL OTHER WARRANTIES, EXPRESS AND IMPLIED, INCLUDING THE WARRANTIES OF MERCHANTABILITY AND FITNESS FOR A PARTICULAR PURPOSE. THE WARRANTY GIVEN ON THIS PAGE SHALL BE STRICTLY LIMITED IN DURATION TO FIVE YEARS FROM THE DATE OF ORIGINAL PURCHASE FROM AN AUTHORIZED MACKIE DEALER. UPON EXPIRATION OF THE APPLICABLE WARRANTY PERIOD, LOUD TECHNOLOGIES INC. SHALL HAVE NO FURTHER WARRANTY OBLIGATION OF ANY KIND. LOUD TECHNOLOGIES INC. SHALL NOT BE LIABLE FOR ANY INCIDENTAL, SPECIAL, OR CONSEQUENTIAL DAMAGES THAT MAY RESULT FROM ANY DEFECT IN THE MACKIE PRODUCT OR ANY WARRANTY CLAIM. Some states do not allow exclusion or limitation of incidental, special, or consequential damages or a limitation on how long warranties last, so some of the above limitations and exclusions may not apply to you. This warranty provides specific legal rights and you may have other rights which vary from state to state.

MACKIE®

16220 Wood-Red Road NE • Woodinville, WA 98072 • USA

United States and Canada: 800.898.3211

Europe, Asia, Central and South America: 425.487.4333

Middle East and Africa: 31.20.654.4000

Fax: 425.487.4337 • www.mackie.com

E-mail: sales@mackie.com

Free Manuals Download Website

<http://myh66.com>

<http://usermanuals.us>

<http://www.somanuals.com>

<http://www.4manuals.cc>

<http://www.manual-lib.com>

<http://www.404manual.com>

<http://www.luxmanual.com>

<http://aubethermostatmanual.com>

Golf course search by state

<http://golfingnear.com>

Email search by domain

<http://emailbydomain.com>

Auto manuals search

<http://auto.somanuals.com>

TV manuals search

<http://tv.somanuals.com>