

MACROM



M1A.15000

Owner's Manual

Front/Rear view

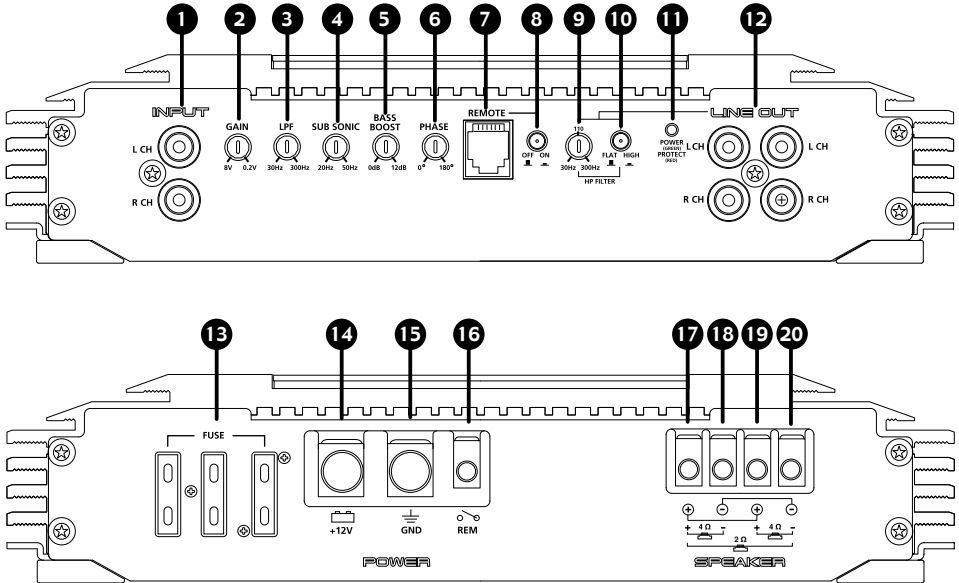

- 1 Low Level Input
- 2 Gain Control
- 3 Low pass cutting adjustment
- 4 Sub Sonic adjustment
- 5 Bass Boost adjustment
- 6 Phase control
- 7 EBC (External Remote control)
- 8 EBC ON/OFF switch
- 9 High pass cutting adjustment
- 10 High pass switch
- 11 Led indicator
- 12 Line Output
- 13 Fuses
- 14 12V (DC) power terminal
- 15 Remote terminal
- 16 GND terminal
- 17 19 + Terminal Speaker
- 18 20 - Terminal Speaker

Input setting

1 Low Level Input

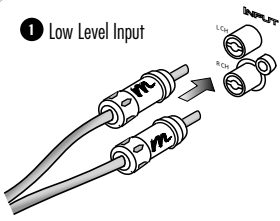

(Eng) Connect the output Audio coming from the car radio, in to the Low level input of the amplifier.

(FR) Relier par un câble RCA de bonne qualité les sorties RCA de l'autoradio aux entrées "Input" RCA de l'amplificateur.

(IT) Collegare l'uscita Audio proveniente dall'autoradio, all'ingresso Low level dell'amplificatore.

(D) Verbinden Sie den Audioausgang (RCA) des Autoradios mit dem RCA Eingang des Verstärkers.

(SP) Para conectar venir audio de la salida de la radio de coche, entrar el nivel bajo del amplificador.

(Eng) Adjust the gain control, according to the Audio level output.

(FR) Ajuster le niveau d'entrée "Gain" de l'amplificateur.

(IT) Regolare il controllo di guadagno, in funzione del segnale Audio in uscita.

(D) Passen Sie mit dem Gainregler die Eing.empfindlichkeit an.

(SP) Ajuste el control del aumento, según la salida llana audio.

2 Gain Control

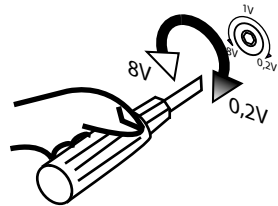

Line Out setting

12 Pre-Output Line out

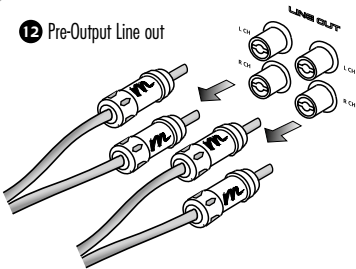

(Eng) The cut frequency is selectable between 30 to 300 Hz.

(FR) La fréquence de coupure est réglable de 30 à 300Hz.

(IT) La frequenza di taglio è selezionabile fra 30 a 300 Hz.

(D) Die Trennfrequenz ist von 30 bis 300 Hz stufenlos einstellbar.

(SP) La frecuencia del corte es seleccionable entre 30 a 300 hertzios.

10

Flat/High switch

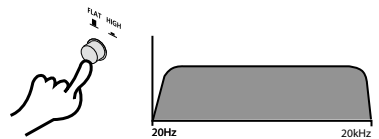

(Eng) Select "FLAT" for a complete frequency range.

(FR) Pour déconnecter le filtre actif, mettre le bouton en position "flat" (Large bande).

(IT) Selezionare "FLAT" per una completa risposta in frequenza.

(D) Wählen Sie "FLAT" für eine Übertr. des ges. Frequenzbereichs.

(SP) Seleccione "FLAT" para una gama de frecuencia del complete.

9

High pass cutting adjustment

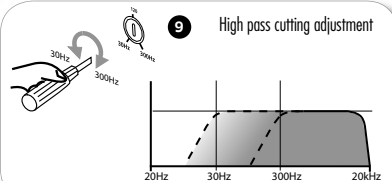

Crossover and Setting

3 Low pass cutting adjustment

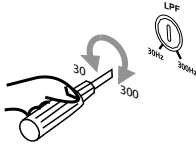

(Eng) The cut frequency is selectable between 30 to 300 Hz.

(FR) La fréquence de coupure est réglable de 30 à 300Hz.

(IT) La frequenza di taglio è selezionabile fra 30 a 300 Hz.

(D) Filterfrequenz einstellbar von 30 bis 300 Hz.

(SP) La frecuencia del corte es seleccionable entre 30 a 300 hertzios.

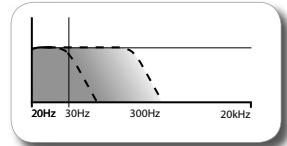

4 Sub Sonic Filter adjustment

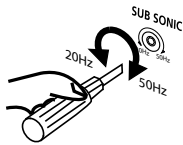

(Eng) Adjust the frequency of departure of the Subsonic filter from 20 to 50Hz in agreement to the connected loudspeaker.

(FR) Ajuster la fréquence de coupure du filtre subsonic de 20 à 50Hz en fonction du subwoofer connecté et de son type de charge.

(IT) Regolare la frequenza di partenza del filtro Subsonic da 20 a 50Hz in accordo all'altoparlante connesso

(D) Stellen Sie die Frequenz des SUB-BASS Filters zwischen 20-50Hz auf einen für die Lautsprecher geeigneten Wert ein..

(SP) Ajuste la frecuencia de la salida del filtro subsónico a partir del 20 a 50Hz en el acuerdo al altavoz conectado.

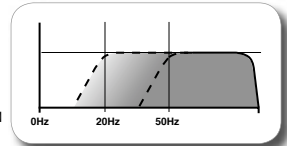

5 Bass Boost adjustment

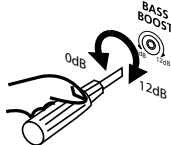

(Eng) It is possible to increase the range of the low frequency being regulated the level of Bass Boost from 0 to +12dB.

(FR) Il est possible d'égaliser le grave de 0 à +12dB à 45Hz.

(IT) E' possibile incrementare la gamma dei bassi regolando il livello di Bass Boost da 0 a +12dB.

(D) Bassanhebung stufenlos von 0 - +12dB regelbar

(SP) Es posible aumentar la gama de la frecuencia baja que es regulada el nivel del alza baja a partir de la 0 a +12dB.

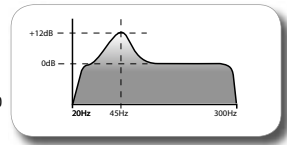

6 Phase adjustment

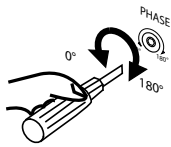

(Eng) With the Phase it is possible to approach or to distance the sound proveniente from the sub in agreement to the point of listen.

(FR) Avec le réglage de phase, il est possible de faire varier virtuellement la position du subwoofer pour qu'il soit en phase avec les hp avant.

(IT) Con la Fase è possibile avvicinare o distanziare il suono proveniente dal sub rispetto al punto di ascolto.

(D) Mit der Phase sich zu nähern ist möglich, oder, das stichhaltige proveniente vom Unterseeboot in der Vereinbarung zum Punkt von höre mir zu überholen.

(SP) Con la fase es posible acercarse o distanciar el proveniente de los sonidos del submarino en el acuerdo al punto del mí escuchó.

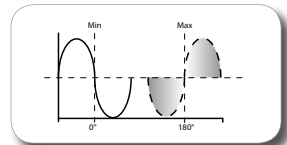

7 EBC (External Bass Control)

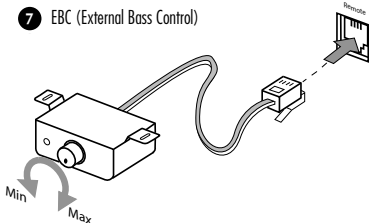

(Eng) Through control Remote EBC, it is possible to control the level of the Volume of the amplifier. Placed control EBC in the front part of the vehicle.

(FR) La commande à distance EBC permet de contrôler le niveau du subwoofer de l'avant du véhicule.

(IT) Tramite il controllo Remote EBC, è possibile controllare il livello del Volume dell'amplificatore. Collocate il controllo EBC nella parte anteriore del veicolo.

(D) Mit der EBC-Fernbedienung ist es möglich die Lautstärke der Basslautsprecher zu regeln. Platzieren Sie die Fernbedienung leicht zugänglich.

(SP) Con el control EBC alejado, es posible controlar el nivel del volumen del amplificador. Control puesto EBC en la parte delantera del vehículo.

Speakers connection

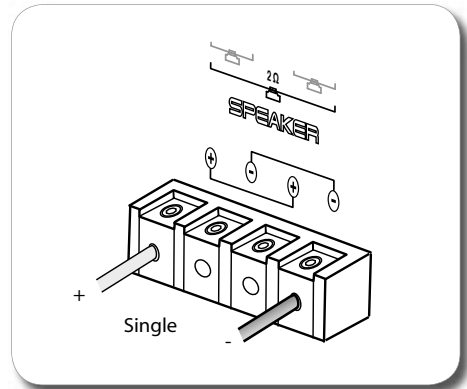
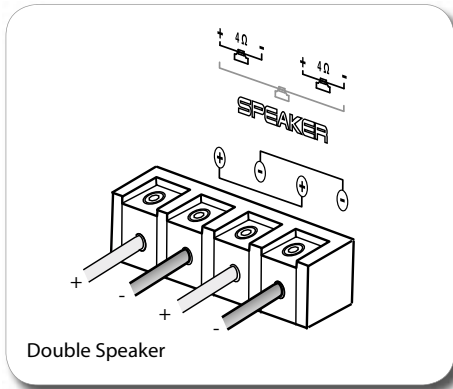

(Eng) Minimal acceptable Impedance 2 ohm. To adhere itself to the illustrations for the connections.

(FR) Impédance minimale 2 ohm en stéréo, 4 ohm ponté. Suivre les illustrations pour les branchements.

(IT) Minima Impedenza accettabile 2 ohm. Attenersi alle illustrazioni per i collegamenti

(D) Minimale Anschlußimpedanz 2 Ohm. Beachten Sie die Abbildungen für die Anschlüsse.

(SP) Impedancia aceptable mínima 2 ohmios. Para adherirse a las ilustraciones para las conexiones.

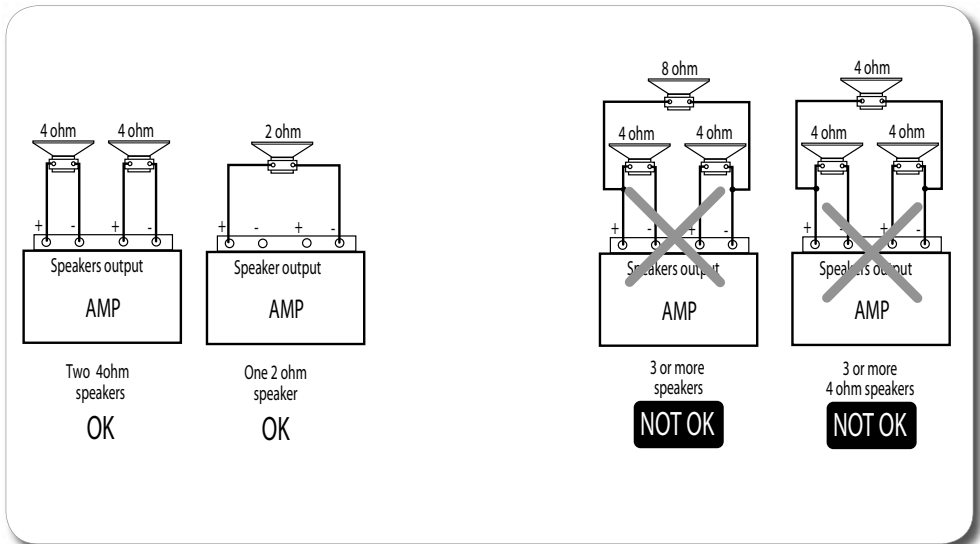

Power connection

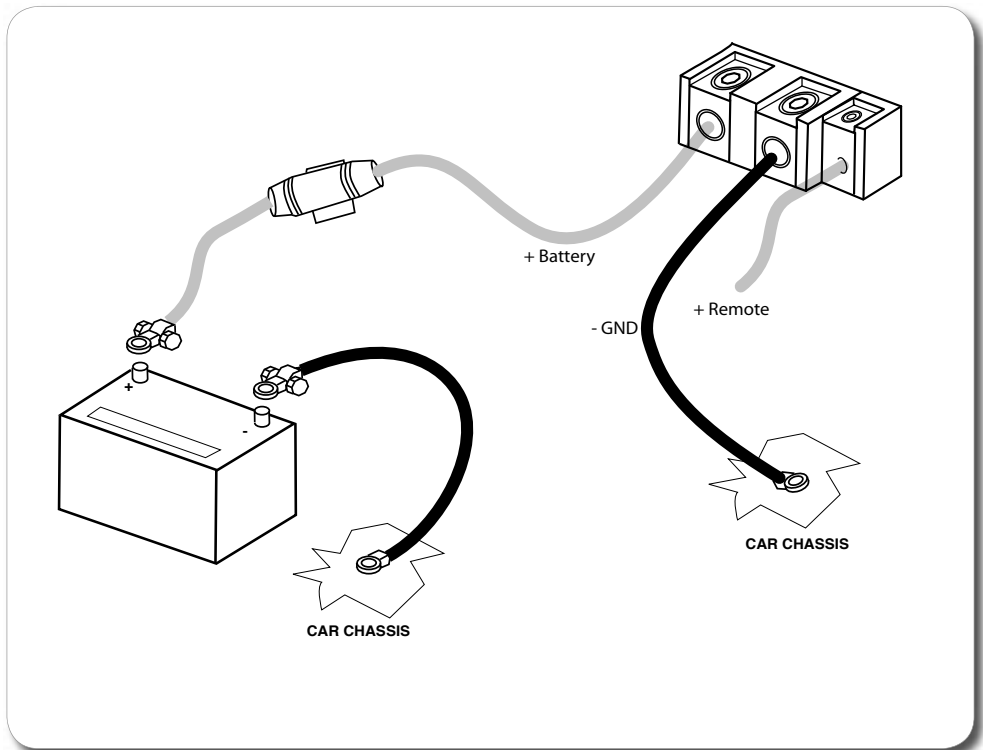

(Eng) Connect the Positive (+12V) directly to the Battery of the car. To make sure itself to insert a fuse of adequate amperage in order protect the system. Connect the Ground in to the car chassis, close as possible to the amplifier.

(FR) Relier la borne +Battery de l'amplificateur directement à la borne +12V de la batterie du véhicule à l'aide d'un câble de section appropriée. Il est indispensable de placer un fusible à moins de 30 cm de la batterie.

Relier la borne -GND de l'amplificateur au châssis du véhicule à l'aide d'un câble de même section que l'alimentation et le plus court possible.

(IT) Collegare il Positivo (+

Collegare il Negativo al telaio dell'automobile, più vicino possibile all'amplificatore.

(D) Schließen Sie das Stromkabel (+12V, Rot) direkt an die Batterie ihres Fahrzeugs an.

Um sich selbst und die Geräte zu schützen verwenden Sie entsprechend dimensionierte Kabel und eine dafür ausgelegte Sicherung. Diese sollte max. 20cm nach der Batterie verbaut werden. Verbinden Sie die Masseleitung (-, Schwarz) mit der Fahrzeugkarosserie. Achten Sie auch hierbei auf eine ausreichende Dimensionierung der Leitungen.

(SP) Conecte el positivo (+12V) directamente con la batería del coche. Para cerciorarse de sí mismo para insertar un fusible del amperaje adecuado en orden proteja el sistema.

Conecte la negativa adentro con el chasis del coche, cierre como sea posible al amplificador.

Features

- **Class D mono channel power amplifier**
- **1500 watts into 2 ohms load**
- **900 watts into 4 ohms load**
- **High efficiency Class D design**
- **Variable Low pass x-over at 24dB/oct**
- **Variable Sub sonic filter from 20 to 55Hz at 24dB/oct**
- **Adjustable from 0 to +12dB at 45Hz Bass Boost**
- **Phase control from 0 to 180°**
- **EBC external bass control**
- **Pre-amplified output with High pass crossover option**
- **PWM Mos-Fet power supply**
- **20sq.mm power terminals**

Technical data

RMS Power at 4 ohm Stereo load at 14,4 volts	900 x 1 watts
RMS Power at 2 ohm Stereo load at 14,4 volts	1500 x 1 watts
THD (total Harmonic Distortion)	< 0,5%
Frequency response (+0/-1 dB)	10 - 300Hz
Signal to noise ratio	> 95dB
Low Input sensitivity	200-8,000mV
Input impedance	22k ohm
Crossover type	Variable 24dB/octave
Crossover frequency (Low-pass)	30 to 300Hz
Sub sonic filter	20 to 50Hz at 24dB/octave
Bass Boost	0 to 12dB @ 40Hz
Phase	0° to 180°
Line Out	1-1 (with High pass)
EBC "External Bass Control"	YES
Dimension (w * h * d) mm	250 x 55 x 430



ALDINET Spa
Viale C. Colombo 8
20090 Trezzano sul Naviglio (MI)
ITALY

Free Manuals Download Website

<http://myh66.com>

<http://usermanuals.us>

<http://www.somanuals.com>

<http://www.4manuals.cc>

<http://www.manual-lib.com>

<http://www.404manual.com>

<http://www.luxmanual.com>

<http://aubethermostatmanual.com>

Golf course search by state

<http://golfingnear.com>

Email search by domain

<http://emailbydomain.com>

Auto manuals search

<http://auto.somanuals.com>

TV manuals search

<http://tv.somanuals.com>