

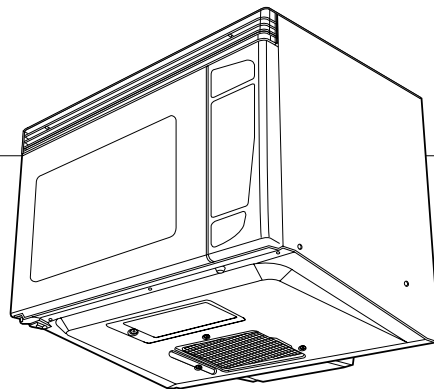

# 22" OVER THE RANGE MICROWAVE OVEN

**MCO2212AR**

OPERATING INSTRUCTIONS &  
COOKING GUIDE



Before operating this oven, please read these instructions completely.

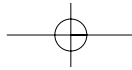

# PRECAUTIONS TO AVOID POSSIBLE EXPOSURE TO EXCESSIVE MICROWAVE ENERGY

- (a) Do not attempt to operate this oven with the door open since open-door operation can result in harmful exposure to microwave energy. It is important not to defeat or tamper with the safety interlocks.
- (b) Do not place any object between the oven front face and the door or allow soil or cleaner residue to accumulate on sealing surfaces.
- (c) Do not operate the oven if it is damaged.  
It is particularly important that the oven door close properly and that there is no damage to the: (1) door (bent), (2) hinges and latches (broken or loosened), (3) door seals and sealing surfaces.
- (d) The oven should not be adjusted or repaired by anyone except properly qualified service personnel.

## TABLE OF CONTENTS

|  |    |
|--|----|
| PRECAUTIONS .....  | 1  |
| IMPORTANT SAFETY INSTRUCTIONS.....   | 2  |
| FEDERAL COMMUNICATIONS COMMISSION RADIO FREQUENCY INTERFERENCE STATEMENT (U.S.A ONLY)..... | 4  |
| GROUNDING INSTRUCTIONS.....  | 4  |
| INSTALLATION .....   | 5  |
| SPECIFICATIONS .....   | 6  |
| FEATURES DIAGRAM .....   | 7  |
| OPERATION PROCEDURE .....  | 9  |
| CONTROLS .....   | 10 |
| CLOCK .....  | 10 |
| AUTO DEFROST .....   | 11 |
| TIME DEFROST .....   | 12 |
| COOKING IN ONE STAGE .....   | 13 |
| COOKING IN TWO STAGES .....  | 13 |
| WEIGHT DEFROST AND COOKING IN TWO STAGES .....   | 14 |
| AUTO START .....   | 15 |
| CHECKING AUTO START TIME .....   | 15 |
| QUICK START .....  | 15 |
| ONE TOUCH COOKING .....  | 16 |
| MORE, LESS .....   | 18 |
| CHILD SAFETY LOCK .....  | 18 |
| USING THE EXHAUST FAN .....  | 18 |
| USING THE COOKTOP LIGHT .....  | 18 |
| SAVING THE ENERGY .....  | 19 |
| TO STOP THE OVEN WHILE THE OVEN IS OPERATION .....   | 19 |
| MICROWAVE UTENSILS .....   | 19 |
| COOKING GUIDE .....  | 21 |
| CARE AND CLEANING .....  | 34 |
| HOW TO CLEAN THE INSIDE .....  | 34 |
| HOW TO CLEAN THE OUTSIDE .....   | 34 |
| THE EXHAUST FEATURE .....  | 35 |
| REUSABLE GREASE FILTER .....   | 35 |
| TO REMOVE GREASE FILTER .....  | 35 |
| LIGHT BULB REPLACEMENT .....   | 36 |
| USE YOUR MICROWAVE OVEN SAFELY .....   | 37 |
| BEFORE YOU CALL FOR SERVICE .....  | 38 |
| QUESTIONS AND ANSWERS .....  | 38 |
| LIMITED 1 YEAR WARRANTY .....  | 39 |

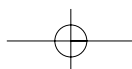

# IMPORTANT SAFETY INSTRUCTIONS.....

When using electrical appliances, basic safety precautions should be followed, including the following:



**WARNING** - To reduce the risk of burns, electric shock, fire, injury to persons or exposure to excessive microwave energy:

1. Read all instructions before using the appliance.
2. Read and follow the specific "PRECAUTIONS TO AVOID POSSIBLE EXPOSURE TO EXCESSIVE MICROWAVE ENERGY" found on page 1.
3. This appliance must be grounded. Connect only to properly grounded outlet. See "GROUNDING INSTRUCTIONS" on page 4.
4. Install or locate this appliance in accordance with the provided installation instructions. Do not mount over a sink.
5. This over-the-range oven was designed for use over ranges no wider than 22 inches. It may be installed over both gas and electric cooking equipment.
6. For best operation, plug this appliance into its own electrical outlet, to prevent flickering of lights, blowing of fuse or tripping of circuit breaker.
7. Some products such as whole eggs and sealed containers-for example, closed glass jars-may explode and should not be heated in this oven. In rare instances, poached eggs have been known to explode. Cover poached eggs and allow a standing time of one minute before cutting into them.
8. Foods with unbroken outer "skin" such as potatoes, sausages, tomatoes, apples, chicken livers and other giblets, and egg yolks (see previous caution) should be pierced to allow steam to escape during cooking. "Boilable" cooking pouches and tightly closed plastic bags should be slit, pierced, or vented.
9. Do not heat, store or use flammable materials in or near the oven. Fumes can create a fire hazard or explosion.
10. Use this appliance only for its intended use as described in this manual. Do not use corrosive chemicals or vapors in this appliance. This type of oven is specifically designed to heat, cook, or defrost food. It is not designed for industrial, laboratory, or commercial use. It is intended for home use only.
11. As with any appliance, close supervision is necessary when used by children.
12. Do not operate this appliance if it has a damaged cord or plug, if it is not working properly, or if it has been damaged or dropped.
13. This appliance should be serviced only by qualified service personnel. Contact nearest authorized service facility for examination, repair or adjustment.
14. Do not cover or block any openings on the appliance.
15. Do not use or store this appliance outdoors. Do not use this product near water - for example, near a kitchen sink, in a wet basement, or near a swimming pool, and the like.
16. Do not immerse cord or plug in water.
17. Keep cord away from heated surfaces.
18. Do not let cord hang over edge of table or counter.
19. When cleaning surfaces of door and oven that come together on closing the door, use only mild, non-abrasive soaps or detergents applied with a sponge or soft cloth.
20. To reduce the risk of fire in the oven cavity:
  - a. Do not overcook food. Carefully attend appliance if paper, plastic, or other combustible materials are placed inside the oven to facilitate cooking. Avoid using recycled paper products. Do not use newspaper or other printed paper in the oven. Such products sometimes contain impurities which could ignite.
  - b. Remove wire twist-ties from paper or plastic bags before placing in oven.
  - c. If materials inside the oven should ignite, keep oven door closed, turn oven off, and disconnect the power cord, or shut off the power at the fuse or circuit breaker panel.
  - d. Do not use the oven for storage. Do not leave paper products, cooking utensils or food in the oven when not in use.
  - e. Do not pop popcorn except in a microwave approved popcorn popper or in a commercial package recommended especially for microwave ovens.
  - f. Do not overcook potatoes. They might dehydrate and catch fire.
  - g. Do not use for drying clothes, lines, newspaper or similar non-food items.
21. Do not operate the oven when empty or with an empty utensil to avoid damage to the oven and danger of fire.

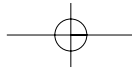

## IMPORTANT SAFETY INSTRUCTIONS.....

22. Do not lean on the oven door. The door is designed to close tightly and seal properly for safe operation. Leaning on the door may warp or break the hinges.
23. To avoid exposure to dangerous high voltage, **DO NOT REMOVE THE SPLATTER SHIELD** inside the oven cavity.
24. Liquids heated in certain shaped containers (especially cylindrical-shaped containers) may become overheated and splash out with a loud noise. For best results, stir the liquid several times before heating. Always stir liquids several times between reheating.
25. **Read and follow specific microwave oven preparation instructions on food packages or containers (especially baby food). Above all, this is a cooking appliance designed to prepare food.**
26. Use only cooking utensils and accessories made for use in the microwave and specifically described in this manual.
27. Microwave oven manufactures do not recommend deep fat frying or frying in a microwave oven. Hot oil can damage oven parts and utensils and even result in skin burns.
28. Plastic wrap: Use only those types designed for microwave oven use and avoid forming and air-tight seal. Fold back a small corner or cut a small slit to allow steam to escape.
29. Stay near the appliance while it is in use and check cooking progress frequently. Leaving the appliance unattended may result in overcooked food and possibly a fire in your oven.
30. Foods cooked in liquids (such as pasta) may tend to boil over more rapidly than foods containing less moisture. Should this occur, refer to the Care and Cleaning section for instructions on how to clean the inside of the oven.
31. Do not use a thermometer in food you are microwaving unless the thermometer is designed or recommended for use in the microwave oven.
32. Plastic cookware designed for microwave cooking is very useful, but should be used carefully. Even microwave-safe plastic may not be as tolerant of overcooking conditions as are glass or ceramic materials and may soften or char if subjected to short periods of overcooking. In longer exposures to overcooking, the food and cookware could ignite. For these reasons: 1) Use microwave-safe plastics only and use them in strict compliance with the cookware manufacturer's recommendations. 2) Do not subject empty cookware to microwaving. 3) Do not permit children to use plastic cookware without complete supervision.
33. **Do not store anything directly on top of the microwave oven surface when the oven is in operation.**
34. TV dinners may be microwaved in foil trays less than 3/4" deep: remove top foil cover and return tray to box. When using metal in microwave oven, keep metal at least 1 inch away from the sides of the oven.
35. Do not defrost frozen beverages in narrow necked bottles.
36. Cookware may become hot because of heat transferred from the heated food. Potholders may be needed to handle the cookware.
37. Do not try to melt paraffin wax in the oven. Paraffin wax will not melt in a microwave oven because it allows microwaves to pass through it.
38. Never use sharp-edged utensils in or near the oven.
39. Hot foods and steam can cause burns. Be careful when opening containers of hot food, including popcorn bags, cooking pouches, and boxes. To prevent possible injury, direct steam away from hands and face.
40. Clean the vent hood often. Do not allow grease to build up on the hood or the filter.
41. Use care when cleaning the vent hood filter. Corrosive cleaning agents, such as lye-based oven cleaners, may damage the filter.
42. When flaming foods are under the hood, turn the fan on.

## SAVE THESE INSTRUCTIONS

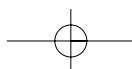

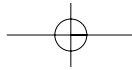

# FEDERAL COMMUNICATIONS COMMISSION RADIO FREQUENCY INTERFERENCE STATEMENT(U.S.A. ONLY)

**WARNING:**

This equipment generates and uses ISM frequency energy and if not installed and used properly, that is in strict accordance with the manufacturer's instructions, may cause interference to radio and television reception.

It has been type-tested and found to comply with limits for an ISM Equipment pursuant to part 18 of FCC Rules, which are designed to provide reasonable protection against such interference in a residential installation.

However, there is no guarantee that interference will not occur in a particular installation.

If this equipment does cause interference to radio or television reception, which can be determined by turning the equipment off and on, the user is encouraged to try to correct the interference by one or more of the followings.

- Reorient the receiving antenna of radio or television.
- Relocate the Microwave oven with respect to the receiver.
- Move the microwave oven away from the receiver.
- Plug the microwave oven into a different outlet so that microwave oven and receiver are on different branch circuits.

THE MANUFACTURER is not responsible for any radio or TV interference caused by UNAUTHORIZED MODIFICATION to this microwave oven. It is the responsibility of the user to correct such interference.

## GROUNDING INSTRUCTIONS

This appliance must be grounded. In the event of an electrical short circuit, the grounding plug reduces the risk of electric shock by providing an escape wire for electric current. This appliance is equipped with a cord having a grounding wire with a grounding plug. The plug must be plugged into an outlet that is properly installed and grounded.

**WARNING:** Improper use of the grounding plug can result in a risk of electric shock.

Consult a qualified electrician or serviceman if the grounding instructions are not completely understood, or if doubt exists as to whether the appliance is properly grounded, and either :

- (1) If it is necessary to use an extension cord, use only a 3-wire extension cord that has a 3-blade grounding plug, and a 3-slot receptacle that will accept the plug on the appliance. The marked rating of the extension cord shall be equal to or greater than the electrical rating of the appliance. or
- (2) Do not use an extension cord, if the power supply cord is too short, have a qualified electrician or serviceman install an outlet near the appliance.

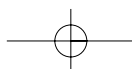

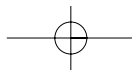

# INSTALLATION

Refer to Installation Manual.

## Power supply

This microwave oven requires a power supply of approximately 15 Amperes, 120 Volts, 60 Hz and a grounded outlet. A short power cord is provided to reduce the risk of the user becoming entangled in or tripping over a longer cord. Longer cord sets or extension cords are available and may be used if care is exercised.

If an extension cord is used, the marked electrical rating of the cord should be at least as great as the electrical rating of the oven.

The extension cord must be a grounding-type 3-wire cord. The longer cord should be arranged so it does not drape over the table top or counter where children can pull on it or trip over it.

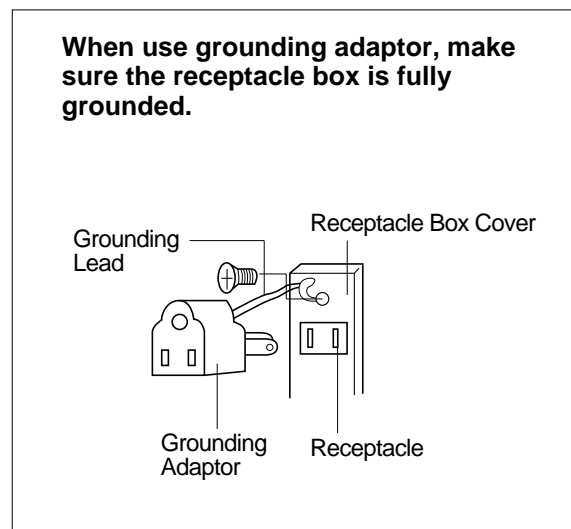
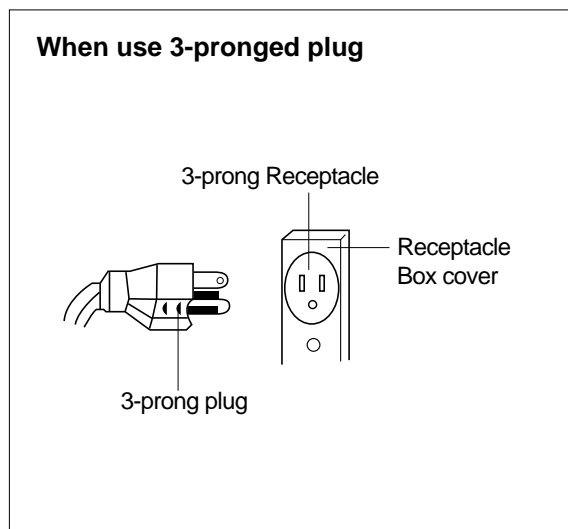

# AUTOMATIC FAN PROTECTION FEATURE

Cooking appliances installed under the oven may, under some heavy usage conditions, cause temperatures high enough to overheat some internal parts of the microwave oven.

To prevent overheating from taking place, the exhaust fan is designed to automatically turn on if excessive temperatures occur. Should this

happen, the fan cannot be manually turned off, but it will automatically turn off when the internal parts have cooled. The fan may stay on up to approximately 30 minutes after the range and microwave oven controls have been turned off.

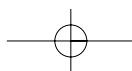

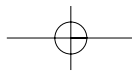

## SPECIFICATIONS

|                                |                   |   |
|--------------------------------|-------------------|---|
| POWER SUPPLY                   |                   | 120V AC 60 Hz SINGLE PHASE WITH GROUNDING   |
| MICROWAVE                      | POWER CONSUMPTION | 1400 W                                      |
|                                | OUTPUT POWER      | 900 W (IEC 705)                             |
|                                | FREQUENCY         | 2450 MHz                                    |
| OUTSIDE DIMENSIONS (W X H X D) |                   | 564 X 407 X 423 mm (22.2 X 16.0 X 16.6 in.) |
| CAVITY DIMENSIONS (W X H X D)  |                   | 374 X 233 X 372 mm (14.7 X 9.2 X 14.6 in.)  |
| NET WEIGHT                     |                   | APPROX. 20 KG (44.1 lbs.)                   |
| TIMER                          |                   | 59 min. 99 sec.                             |
| POWER LEVELS                   |                   | 10 LEVELS                                   |

\* Specifications subject to change without notice.

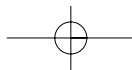
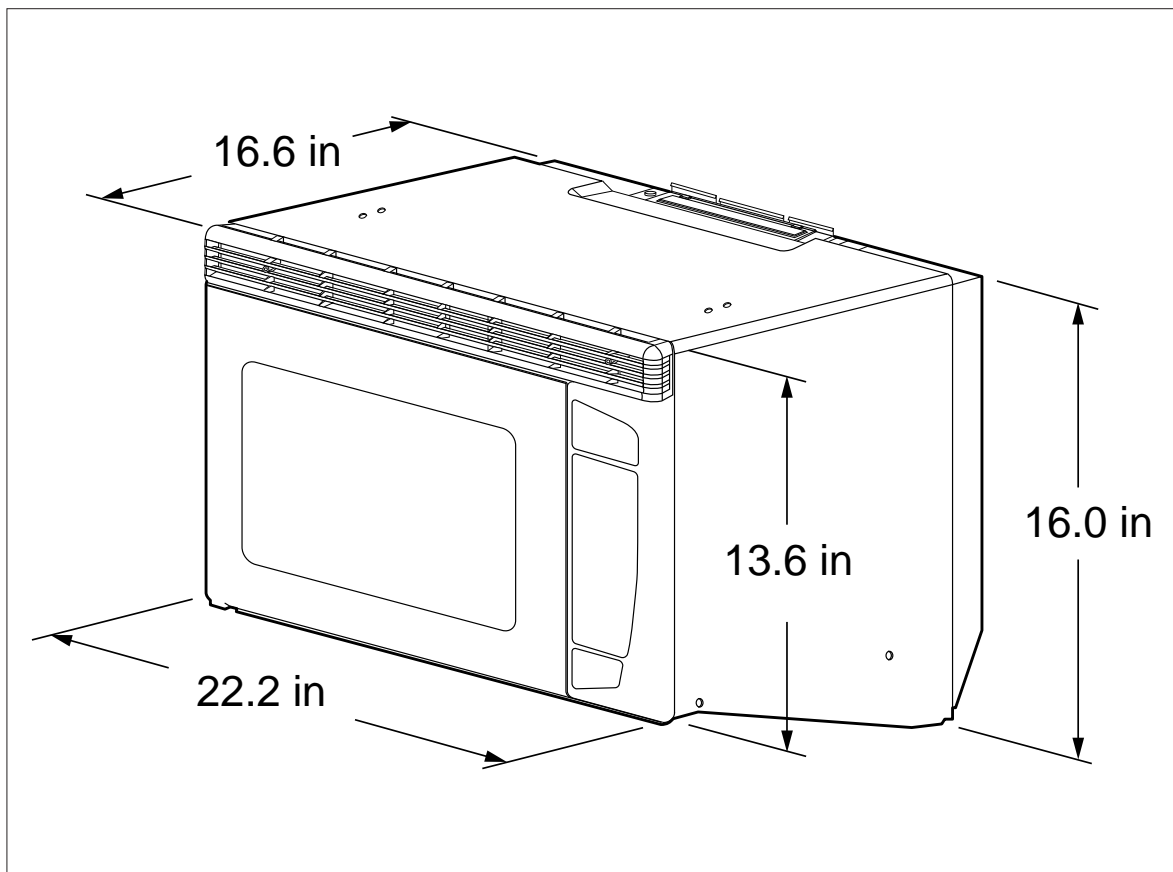

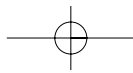

## FEATURES DIAGRAM

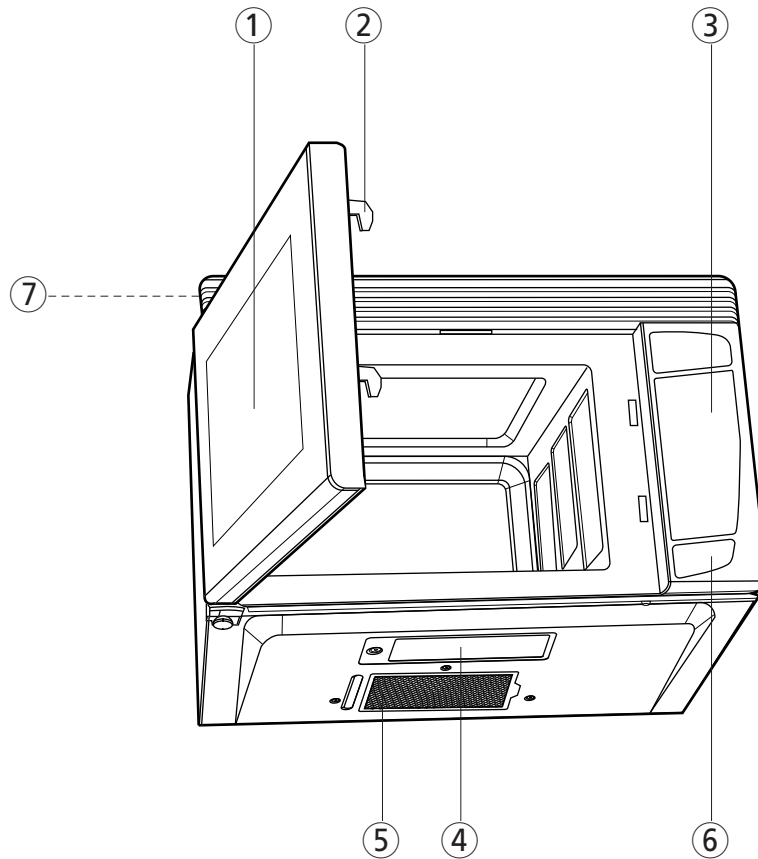

**1. Door screen** - Allows viewing of food.  
The screen is transparent to light, but prevents microwave escaping.

**2. Door latch** - When the door is closed it will automatically shut off. If the door is opened while the oven is operating, magnetron will automatically shut off.

**3. Control panel**

**4. Cooktop light**

**5. Grease filter**

**6. Door release button** - Pushing this button stops oven operation and opens the door.

**7. Charcoal filter (optional, not shown)**

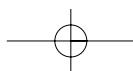



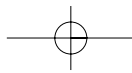

## FEATURES DIAGRAM (continued)

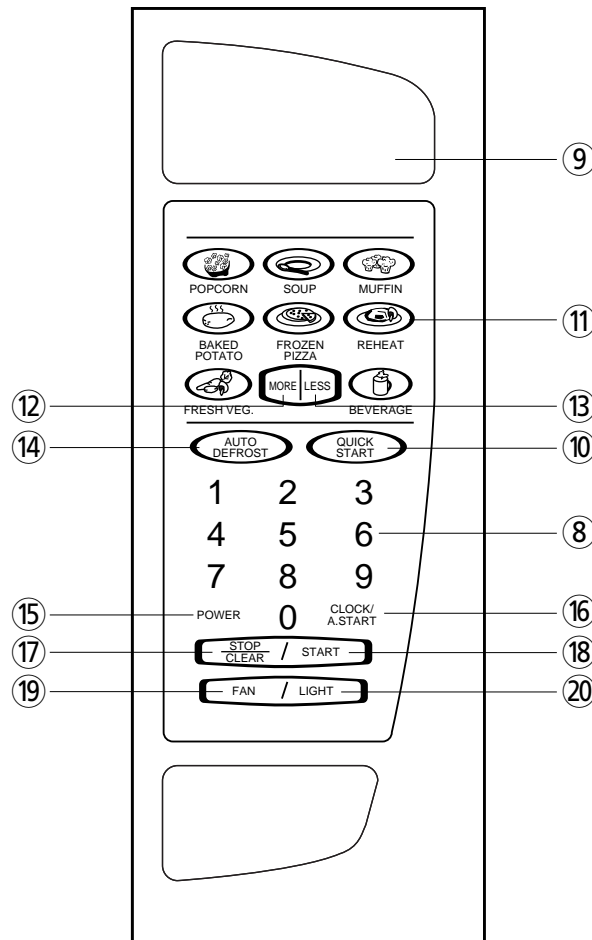

**8. Time set pad** - Used to set the cooking time and the present time.

**9. Display** - Cooking time, power level, indicators and present time are displayed.

**10. Quick start** - Touch to set the desired reheat time by 30 seconds.

**11. One touch** - Used to cook or reheat specific quantities of food. See pages 14-16.

**12. More** - Used to add time to one touch cooking.

**13. Less** - Used to remove time from one touch cooking.

**14. Auto defrost** - Used to defrost foods.

**15. Power** - Used to set power level.

**16. Clock/A.start (Auto Start)** - Used to set clock and also used to set a delayed auto start.

**17. Stop/Clear** - Used to stop the oven operation or to delete the cooking data.

**18. Start** - Used to start the oven.

**19. Fan** - Used to turn on the exhaust fan.

**20. Light** - Used to turn on the cooktop light.

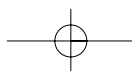

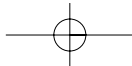

# OPERATION PROCEDURE

This section includes useful information about oven operation.

1. Plug power supply cord into a standard 3- pronged 15 Amp, 120V AC 60Hz power outlet.
  2. After placing the food in a suitable container, open the oven door and put it on the glass tray.  
The glass tray and roller guide must always be in place during cooking.
  3. Shut the door. Make sure that it is firmly closed.
- 1 The oven light is on only when the microwave oven is operating.
  - 2 The oven door can be opened at any time during operation by touching the door release button on the control panel. The oven will automatically shut off. To restart the oven, close the door and then touch START pad.
  - 3 Each time a pad is touched, a BEEP will sound to acknowledge the touch.
  - 4 The oven automatically cooks on full power unless set to a lower power level.
  - 5 The display will show ":0" when the oven is plugged in.
  - 6 Time clock returns to the present time when the cooking time ends.
  - 7 When the STOP/CLEAR pad is touched during the oven operation, the oven stops cooking and all information retained.  
To erase all information (except the present time), touch the STOP/CLEAR pad once more. If the oven door is opened during the oven operation, all information is retained.
  - 8 If the START pad is touched and the oven does not operate, check the area between the door and door seal for obstructions and make sure the door is closed securely.  
The oven will not start cooking until the door is completely closed or the program has been reset.

Make sure the oven is properly installed and plugged into the electrical outlet.

## WATTAGE OUTPUT CHART

• The power-level is set by pressing the POWER pad. The chart shows the display, the power level and the percentage of power.

| Touch POWER pad | Power Level (Display) | Approximate Percentage of Power |
|-----------------|-----------------------|---------------------------------|
| POWER           | P-HI                  | 100%                            |
| 9               | P-90                  | 90%                             |
| 8               | P-80                  | 80%                             |
| 7               | P-70                  | 70%                             |
| 6               | P-60                  | 60%                             |
| 5               | P-50                  | 50%                             |
| 4               | P-40                  | 40%                             |
| 3               | P-30                  | 30%                             |
| 2               | P-20                  | 20%                             |
| 1               | P-10                  | 10%                             |
| 0               | P-0                   | 0%                              |

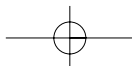

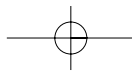

# CONTROLS

## CLOCK

When the oven is first plugged in, the display will flash ":0" and a tone will sound. If the AC power ever turns off, the display shows ":0" when the power comes back on.

CLOCK/  
A.START

1. Touch CLOCK/A.START pad. This is a 12 hour clock system and "12H" is displayed.
2. Touch CLOCK/A.START pad once more. This is a 24 hour clock system and "24H" is displayed.

**NOTE:** This oven has multiple clock system. If you want 24 hour clock system, omit this step (step 2).

3. Enter the correct time of day by touching the time set pads. The selected time blinks.

CLOCK/  
A.START

4. Touch CLOCK/A.START pad. The display stops blinking and the colon starts blinking.

**NOTE:** 1. If you selected 12 hour clock system, this digital clock allows you to set from 1:00 to 12:59.  
If you selected 24 hour clock system, this digital clock allows you to set from 0:00 to 23:59.  
2. If you attempt to enter an incorrect time, the time will not be set and an error signal tone will sound. Touch CLOCK/A.START pad and re-enter the correct time.

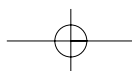

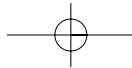

## AUTO DEFROST

AUTO DEFROST lets you easily defrost food by eliminating guesswork in determining defrosting time. The defrosting time is automatically determined by weight entered. Follow the steps below for easy defrosting.



1. Touch AUTO DEFROST pad. "0.0" is displayed and the lb indicator starts blinking.

2. Touch number pads for the desired defrosting weight. The display will show you what you touched.



3. Touch START pad. The display is changed into cooking time and counts down the remaining time. The oven beeps during the defrosting cycle to signal that the food needs to be turned or rearranged. When the defrosting time ends, you will hear 3 beeps.

**NOTE:** The minimum weight for AUTO DEFROST is 0.5lb and the maximum weight is 6.5lb. If you attempt to enter an improper weight, the weight will not be set and an error signal tone will sound. Reset the weight and touch START pad.

## AUTO DEFROST GUIDE

1. Unwrap item being defrosted. rotating the item, separating defrosted pieces or sections or shielding.
2. Put the food on a microwave rack or in a microwave-safe dish. After first or second signal, change the position of the item being defrosted, this includes turning over the item, Shield warm areas with small pieces of foil.
3. Min.-max. Weight:0.5-6.5 lbs.

| Recommended foods.    | Instructions   | Stand time    |
|-----------------------|--|---------------|
| <b>Meat</b>           |  |               |
| Chops                 | Separate, turn over and shielded where necessary                           | 5 minutes     |
| Frankfurters, sausage | Separate and remove defrosted pieces.                                      | 2 minutes     |
| Ground meat           | Turn over, remove defrosted areas and break apart.                         | 5 minutes     |
| Beef patties          | Turn over and separate patties.<br>Remove defrosted pieces.                | 5 minutes     |
| Roast                 | Turn over and shielded.  | 30-90 minutes |
| Ribs                  | Separate. Turn over and remove defrosted pieces.<br>Shielded if necessary. | 5 minutes     |
| Steak                 | Turn over and shielded.  | 5 minutes     |
| Stew                  | Separate and remove defrosted pieces.                                      | 5 minutes     |

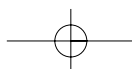

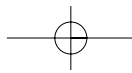

| Recommended foods.             | Instructions                          | Stand time  |
|--------------------------------|---------------------------------------|---|
| <b>Poultry</b>                 |                                       |   |
| Whole chicken                  | Turn over and shiled.                 | 10 minutes, run cold water in cavity.                 |
| Turkey breast (breast side up) | Turn over and shiled.                 | 20 minutes in refrigerator; Run cold water in cavity. |
| Chicken pieces                 | Separate and remove defrosted pieces. | 5 minutes   |
| Cornish hens (whole)           | Turn over and shiled where necessary. | 10 minutes; run cold water in cavity.                 |
| Cornish hens (split)           | Turn over and shiled.                 | 5 minutes   |
| <b>Seafood</b>                 |                                       |   |
| Fish fillets                   | Separate and remove defrosted pieces. | 5 minutes   |
| Shrimps, scallops              | Separate and remove defrosted pieces. | 5 minutes   |
| Whole fish                     | Turn over and shiled tail and head.   | 5 minutes; hold under cold running water.             |

## TIME DEFROST

When TIME DEFROST is selected, the automatic cycle divides the defrosting time into periods of alternating defrost and stand times by cycling on and off.

|   |   |   |
|---|---|---|
| <div style="border: 1px solid black; padding: 5px; text-align: center;"> <b>AUTO DEFROST</b> </div> | 1. Touch AUTO DEFROST pad.                            | The WEIGHT DEFROST indicator light and "0.0" is displayed. And the lb indicator starts blinking.  |
|   | 2. Touch AUTO DEFROST pad once more.                  | The TIME DEFROST indicator lights and ":0" is displayed.  |
|   | 3. Touch number pads for the desired defrosting time. | The display will show you what you touched.   |
| <div style="border: 1px solid black; padding: 5px; text-align: center;"> <b>START</b> </div>        | 4. Touch START pad.                                   | The TIME DEFROST indicator starts blinking to show the oven is in the TIME DEFROST mode. The display counts down the time to show you how much defrosting time is left in the TIME DEFROST mode. The oven beeps during the defrosting cycle to signal that the food needs to be turned or rearranged. When the defrosting time ends, you will hear 3 beeps. |

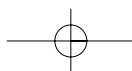

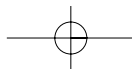

## COOKING IN ONE STAGE

|       |  |  |
|-------|--|--|
| POWER | 1. Touch POWER pad.  | The STAGE1 indicator lights and "P-" is displayed.   |
|       | 2. Touch the number pad for desired power level.                                       | This display will show you what you touched. This example shows power level 3.   |
|       | <div style="border: 1px solid black; display: inline-block; padding: 2px 5px;">3</div> |  |
| START | 3. Touch number pads for the cooking time.   | The display will show you what you touched.  |
|       | 4. Touch START pad.  | The STAGE1 indicator starts blinking to show the oven is in the cooking mode. The display counts down the time to show how much cooking time is left. When the cooking time ends, you will hear 3 beeps. |

**NOTE:** 1. If steps 1 and 2 are omitted, the oven will cook at full power.  
 2. Your oven can be programmed for 59 minutes 99 seconds.(59:99)  
 3. Using lower power level increases the cooking time which is recommended for foods such as cheese, milk and slow cooking of meats.

## COOKING IN TWO STAGES

For best results, some recipes call for one power level for a certain length of time and another power level for a different length of time.

Your microwave oven can be set to change from one to another.

|  |  |  |
|--|--|--|
| <div style="display: inline-block; border: 1px solid black; padding: 2px 5px; margin-right: 5px;">5</div> <div style="display: inline-block; border: 1px solid black; padding: 2px 5px; margin-right: 5px;">3</div> <div style="display: inline-block; border: 1px solid black; padding: 2px 5px;">0</div> | 1. Touch number pads for the desired cooking time in the first stage.      | The STAGE1 indicator lights and the display will show you what you touched. This example shows 5 minutes 30 seconds at full power.   |
| POWER  | 2. Touch POWER pad.  | The STAGE2 indicator lights and "P-" is displayed.   |
|  | 3. Touch the number pad for the power level you want in the second stage.  | The display will show what you touched.  |
|  | 4. Touch the number pads for the desired cooking time in the second stage. | The display will show what you touched.  |
| START  | 5. Touch START pad.  | Both STAGE 1 & 2 indicator lights come on and STAGE 1 indicator light starts blinking to show you that the oven is cooking in the first of two cook stages.<br>The oven will cook at the power you selected for STAGE 1. At the end of STAGE 1, the oven will beep and start STAGE 2, the STAGE 1 indicator disappears and the STAGE 2 indicator starts blinking. The display counts down the time remaining in STAGE 2. When STAGE 2 ends, you will hear 3 beeps. |

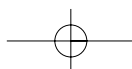

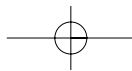

## WEIGHT DEFROST AND COOKING IN TWO STAGES

All recipes require frozen foods to be defrosted fully before cooking.  
 This oven can be programmed to automatically defrost foods before cooking.

|                            |  |   |
|----------------------------|--|---|
| <p><b>AUTO DEFROST</b></p> | <p>1. Touch AUTO DEFROST pad.</p>  | <p>The WEIGHT DEFROST indicator appears and "0.0" is displayed. The lb indicator starts blinking.</p>   |
|                            | <p>2. Touch number pads for the defrosting weight you want.</p>                          | <p>The display will show you what you touched.</p>  |
| <p><b>POWER</b></p>        | <p>3. Touch POWER pad.</p>   | <p>The STAGE1 indicator appears and "P- " is displayed.</p>   |
|                            | <p>4. Touch the number or POWER pad for the power level you want in the first stage.</p> | <p>The selected power level is displayed in the display window.</p>   |
|                            | <p>5. Touch number pads for the desired cooking time in the first stage.</p>             | <p>The display will show you what you touched.</p>  |
| <p><b>POWER</b></p>        | <p>6. Touch POWER pad.</p>   | <p>The STAGE2 indicator appears and "P-" is displayed.</p>  |
|                            | <p>7. Touch the number pad for the power level you want in the second stage.</p>         | <p>The selected power level is displayed.</p>   |
|                            | <p>8. Touch the number pads for the cooking time you want in the second stage.</p>       | <p>The display will show you what you touched.</p>  |
| <p><b>START</b></p>        | <p>9. Touch START pad.</p>   | <p>The WEIGHT DEFROST, STAGE1 and STAGE2 indicators appear simultaneously and the WEIGHT DEFROST indicator starts blinking to show you that the oven is in WEIGHT DEFROST mode. The display counts down the time remaining in WEIGHT DEFROST mode.<br/>                 When the oven beeps, turn over, break a part and redistribute at a beep. At the end of WEIGHT DEFROST mode, the oven will beep and start STAGE 1. The WEIGHT DEFROST indicator disappears and the STAGE 1 indicator starts blinking. The display counts down the time remaining in STAGE 1. At the end of STAGE 1, the oven will beep and start STAGE2.<br/>                 The STAGE1 indicator disappears and the STAGE2 indicator starts blinking. The display counts down the time remaining in STAGE2. When STAGE2 ends, you will hear 3 beeps.</p> |

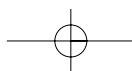

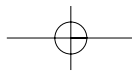

## AUTO START

Auto start can be programmed for up to two cooking stages.  
Auto start can not be programmed for auto defrost.

|                           |   |   |
|---------------------------|---|---|
|                           | 1. Program the desired power level and cooking time for food to be cooked.' |   |
| <b>CLOCK/<br/>A.START</b> | 2. Touch CLOCK/A.START pad.   | The AUTO START indicator appears and ":0" is displayed.   |
|                           | 3. Enter the desired start time by touching number pads.                    | The display will show you what you touched.   |
| <b>START</b>              | 4. Touch START pad.   | The present time & the cooking program indicator appear in the display and the AUTO START indicator & colon start blinking. When the selected start time arrive, the oven light turns on and the oven begins operating. The AUTO START indicator disappears and the next stage indicator begins to blink. When the cooking is completed, you will hear 3 beeps. The oven light turns off and the present time appears in the display. |

**NOTE:** AUTO START can be used for time cooking, if the clock is set. If the oven door is opened after programming AUTO START, it is necessary to touch the START pad for the time of day to appear in the readout so that the oven will automatically begin programmed cooking at the chosen AUTO START time.  
Before setting, check to make sure the clock is showing the correct time of day.

## CHECKING AUTO START TIME

Once AUTO START has correctly been programmed, the present time will appear on the display.

|                           |                             |  |
|---------------------------|-----------------------------|--|
| <b>CLOCK/<br/>A.START</b> | 1. Touch CLOCK/A.START pad. | The programmed AUTO START time will appear on the display for 3 seconds. |
|---------------------------|-----------------------------|--|

## QUICK START

QUICK START allows you to reheat for 30 seconds at 100% (full power) by simply touching the QUICK START pad.  
By repeatedly touching the QUICK START pad, you can also extend reheating time to 5 minutes by 30 seconds.

|                        |                           |  |
|------------------------|---------------------------|--|
| <b>QUICK<br/>START</b> | 1. Touch QUICK START pad. | " :30" is displayed and the oven starts reheating after 1.5 seconds. |
|------------------------|---------------------------|--|

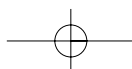



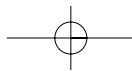

## ONE TOUCH COOKING

One touch cooking allows you to cook or reheat many of your favorite foods by touching just one pad. To increase quantity, touch chosen pad until number in display is the same as the desired quantity to cook. (except for MUFFIN & REHEAT) For best results, consult the cookbook.

### POPCORN

1. Touch POPCORN pad once for a 3.5 oz bag or twice for a 1.75 oz bag.

“3.5” or “1.75” is displayed with oz indicator. After 1.5 seconds, the oven starts cooking and oz indicator disappears. Also the display changes into cooking time and counts down the remaining time. When the cooking time ends, you will hear 3 beeps.

#### \* POPCORN \*

- 3.5 oz : Touch POPCORN pad once.
- 1.75 oz : Touch POPCORN pad twice within 1.5 seconds.

- NOTE:**
1. Use prepackaged room-temperature microwave popcorn.
  2. Place bag in oven according to manufacturer's directions.
  3. Pop only one bag at a time.
  4. After popping, open bag carefully. Popcorn and steam are extremely hot.
  5. Do not reheat unpopped kernels or reuse bag.
  6. Do not leave oven unattended while popping corn.

**CAUTION :** If prepackaged popcorn is of a different weight than the recommended weight, do not use the popcorn pad. Follow the manufacturer instruction.

### SOUP

1. Touch SOUP pad once for 8 oz soup or twice for 12 oz soup.

“8” or “12” is displayed with oz indicator. After 1.5 seconds, the oven starts cooking and oz indicator disappears. Also the display changes into cooking time and counts down the remaining time. When the cooking time ends, you will hear 3 beeps.

#### \* SOUP \*

- 8 oz : Touch SOUP pad once.
- 12 oz : Touch SOUP pad twice within 1.5 seconds.

### MUFFIN

1. Touch MUFFIN pad once to cook 5 muffins.

“5” is displayed with NO indicator. After 1.5 seconds, the oven starts cooking and NO indicator disappears. Also the display changes into cooking time and counts down the remaining time. When the cooking time ends, you will hear 3 beeps.

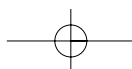

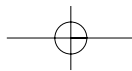

**BAKED POTATO**

1. Touch BAKED POTATO pad once for 1 NO, twice for 2 NO or three times for 3 NO baked potato.

“1”, “2” or “3” is displayed with NO indicator. After 1.5 seconds, the oven starts cooking and NO indicator disappears. Also the display changes into cooking time and counts down the remaining time. When the cooking time ends, you will hear 3 beeps.

**\* BAKED POTATO \* (5.5oz ~ 6.5oz / EA.)**

- 1 NO (EA.) : Touch BAKED POTATO pad once.
- 2 NO (EA.) : Touch BAKED POTATO pad twice within 1.5 seconds.
- 3 NO (EA.) : Touch BAKED POTATO pad three times within 1.5 seconds.

**FROZEN PIZZA**

1. Touch FROZEN PIZZA pad once for 7 oz pizza or twice for 10 oz pizza.

“7” or “10” is displayed with oz indicator. After 1.5 seconds, the oven starts cooking and oz indicator disappears. Also the display changes into cooking time and counts down the remaining time. When the cooking time ends, you will hear 3 beeps.

**\* FROZEN PIZZA\***

- 7 oz : Touch FROZEN PIZZA pad once.
- 10 oz : Touch FROZEN PIZZA pad twice within 1.5 seconds.

**NOTE:** 1. Use only one frozen pizza at a time.  
 2. Use only frozen pizza for microwave oven.  
 3. If the cheese of frozen pizza does not melt sufficiently, cook a few seconds longer.  
 4. Some brands of frozen pizza may require more or less cooking time.

**REHEAT**

1. Touch REHEAT pad once.

“11” is displayed with oz indicator. After 1.5 seconds, the oven starts cooking and oz indicator disappears. Also the display changes into cooking time and counts down the remaining time. When the cooking time ends, you will hear 3 beeps.

**FRESH VEG**

1. Touch FRESH VEG pad once for 8 oz fresh vegetable or twice for 12 oz fresh vegetable.

“8” or “12” is displayed with oz indicator. After 1.5 seconds, the oven starts cooking and oz indicator disappears. Also the display changes into cooking time and counts down the remaining time. When the cooking time ends, you will hear 3 beeps.

**\* FRESH VEGETABLE \***

- 8 oz : Touch FRESH VEG pad once.
- 12 oz : Touch FRESH VEG pad twice within 1.5 seconds.

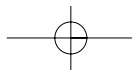

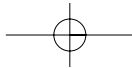

## BEVERAGE

1. Touch BEVERAGE pad once for 1 cup, twice for 2 cups or three times for 3 cups.

“1”, “2” or “3” is displayed with CUPS indicator. After 1.5 seconds, the oven starts cooking and CUPS indicator disappears. Also the display changes into cooking time and counts down the remaining time. When the cooking time ends, you will hear 3 beeps.

### \* BEVERAGE \*

- 1 cup (mug) : Touch BEVERAGE pad once.
- 2 cups (mugs) : Touch BEVERAGE pad twice within 1.5 seconds.
- 3 cups (mugs) : Touch BEVERAGE pad three times within 1.5 seconds.

**NOTE:** 1. This setting is good for restoring cooled beverage to a better drinking temperature.  
2. Stir after cooking.

## MORE, LESS

To increase/decrease one touch cooking time, use MORE/LESS pad before pressing one touch cooking pad. The overall one touch cooking time can be increased/decreased to 20 seconds by 10 seconds.

## CHILD SAFETY LOCK

The safety lock prevents unwanted oven operation such as by small children. To set, press STOP/CLEAR pad for 3 seconds and LOCK indicator appears with a beep sound. To cancel, press STOP/CLEAR pad for 3 seconds and LOCK indicator disappears with a beep sound.

## USING THE EXHAUST FAN

To turn on the exhaust fan, touch FAN pad once,  
To turn off the exhaust fan, touch FAN pad once more.

**NOTE:** If the temperature gets too hot around the microwave oven, the exhaust fan in the vent hood will automatically turn on for cooling. It may stay on up to an hour to cool the microwave oven. When this occurs, the FAN OFF pad will not turn the fan off.

## USING THE COOKTOP LIGHT

To turn on the cooktop light, touch LIGHT pad once,  
To turn off the cooktop light, touch LIGHT pad once more.

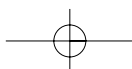

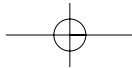

## SAVING THE ENERGY

To set, press number pad "0" for 3 seconds and the display turns off with a beep sound.

To cancel, press number pad "0" for 3 seconds and the display returns to present time with a beep sound.

**NOTE:** 1. If you touch any pad once while this function is set, the display will show the present time. If you touch the desired function pad in sequence within 10 seconds, the oven starts operating. When the cooking is completed, you will hear 3 beeps and the display will show you the present time. After 10 seconds, the display turns off again with a beep sound.

## TO STOP THE OVEN WHILE THE OVEN IS OPERATION

1. Press STOP/CLEAR pad.

- You can restart the oven by touching START pad.
- Touch STOP/CLEAR pad once more to erase all instructions.
- You must enter in new instructions.

2. Open the door.

- You can restart the oven by closing the door and touching START pad.

**NOTE:** Oven stops operating when door is opened.

## MICROWAVE UTENSILS

| UTENSIL TEST | <p>Dishes that do not absorb microwave energy are best for microwave cooking. Look on the label to verify that particular cups, glasses, plates are indeed suitable, especially paper goods. If you are not sure, try this utensil test to check.</p> <ul style="list-style-type: none"> <li>• Put the empty utensil in the microwave oven.</li> <li>• Put one cup of water in a glass measure next to the empty utensil.</li> <li>• Heat on HI for 1 minute.</li> <li>• After 1 minute the water should be warm but the utensil should not. If the utensil is warm, it is not suitable for microwave cooking.</li> </ul> |
|--------------|---|
|--------------|---|

### *Glass, Ceramic and China*

Ovenproof glass or ceramic baking dishes are the most used microwave utensils.

Many of these items are readily available in most homes : glass measure, custard cups, mixing bowls, covered casseroles, pie plates and round or square cake dishes. Ovenproof dinner ware is usually safe to use in the microwave.

Do not heat or cook in glass jars or bottles.

Do not use dishes with silver, gold, platinum or other metal trim. Arcing may occur and /or the dish may break.

Do not use delicate or stemmed glassware. Although the glass may be transparent to microwave energy, heat from the food may cause the glassware to crack.

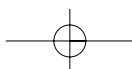

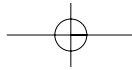

## ***Plastics***

Plastic dishes, cups, mugs and bowls may be used in the oven for short periods of time. None of these should be used in the oven for prolonged periods because distortion and melting may occur. Check manufacturer's recommendations concerning microwave safety.

Plastic wrap can be used to cover dishes in most recipes if the dish is deep enough to avoid plastic wrap touching the food. Always vent the wrap by folding back one corner to allow excess steam to escape.

Plastic cooking bags should be slit before cooking so excess steam can escape. Do not use wire twist ties to close the bag. Wire twist ties can cause arcing which can damage the oven.

## ***Paper***

Paper cups, wax paper, napkins, paper towels, and plates may be used for short cooking. Prolonged time in the oven can cause paper to burn. Do not use recycled paper products, such as brown paper bags. They contain impurities which may cause arcing and damage the oven.

## ***Metal***

Metal utensils should not be used in the oven. Metal reflects microwave energy so foods will not cook so foods will not cook evenly. Metal can cause arcing and damage the oven.

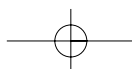

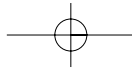

# COOKING GUIDE

## VEGETABLES

Vegetables are favorite foods when cooked in the microwave. Because they cook for a shorter time and require less water than conventional cooking, vegetables cooked by microwave energy retain more vitamins than when cooked by other methods.

To cook better in the microwave, vegetables should be cut into evenly sized pieces. Baked potatoes, squash, or vegetables with skins can be pierced with a fork and arranged in a circle for the best cooking results. Uneven vegetables such as asparagus or broccoli, can be

arranged in the dish alternating thick and thin ends. Stirring, rearranging, turning over and rotating are effective techniques to maximize the way microwave energy cooks vegetables.

Use care in removing lid to prevent steam burn. Standing time is an important element in successful cooking because additional cooking will take place then. Make a decision about desired doneness after the standing time then add more time, if needed.

### LIGHT BAKED POTATOES

- 4 baking potatoes, about 8 oz. each salt and pepper
- 2 cups low fat cottage cheese
- 1/2 cup sliced green onions
- 2 tablespoons chopped fresh parsley
- Paprika

1. Scrub potatoes and pierce several times with a fork. Arrange in a circle on a microwave rack.
2. Cook, uncovered, on P-HI for 8 minutes. Turn each potato over. Continue cooking on P-HI for 6 to 8 minutes, or until potatoes are soft if squeezed lightly. Let stand for 5 minutes. Cut slit on top of potato and press ends to make opening for stuffing. Salt and pepper to taste.
3. Meanwhile in a small bowl, combine cottage cheese, green onions and parsley. Divide mixture evenly among potatoes. Arrange stuffed potatoes in a circle on a serving platter. Sprinkle with paprika

**4 servings**

### SPINACH AND ARTICHOKE DIP

- 2 tablespoons chopped onion
- 1 medium red bell pepper, chopped (about 1 cup)
- 1 clove garlic, minced
- 1 package (10 oz.) frozen chopped spinach, defrosted
- 1 can (14 oz.) artichoke hearts, drained and chopped
- 1 package (8 oz.) cream cheese, softened
- 1 tablespoon lemon juice
- 1 teaspoon seasoned salt
- 1/4 teaspoon hot pepper sauce

1. In a 2-quart casserole, combine onion, bell pepper, and garlic.
2. Cook, uncovered, on P-HI for 3 minutes or until red pepper is crisp-tender; drain spinach and squeeze dry. Add spinach, artichokes hearts, cream cheese, lemon juice, salt and hot pepper sauce to red pepper mixture; stir to mix well. Serve warm.

**3 cups**

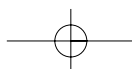

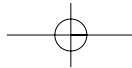

# EGGS AND CHEESE

Eggs and cheese are delicate foods requiring care in microwave cooking. Piercing the yolks of eggs helps to release steam during cooking. Stirring egg mixtures frequently helps distribute the heat evenly. Because the microwave energy cooks so quickly, always check to see if the eggs are done to your satisfaction after the standing time. At this time, stir, rearrange or turn over. If needed, add additional time gradually. To cook only one egg, try a lower Power setting until you get satisfactory results.

well if stirred into a hot mixture. Cheese may not look melted so always stir before determining if cheese is melted enough. Sprinkle cheese over a hot casserole in a thicker layer at the edges. Microwave energy cooks from the outside in, so the outer edges will melt faster than the center.

For cheese melt sandwiches, heat filling where possible before adding it to the bread. Top each sandwich with a slice of cheese and cook on P-HI for about 15 to 20 seconds for one sandwich, about 30 seconds for two sandwiches and about 1 minute for four sandwiches or until cheese is melted.

Shredded soft cheeses and grated hard cheeses melt

## HARD-COOKED EGGS

4 eggs

1. In a 4-cup glass measure, break eggs. Pierce each yolk twice with a fork.
2. Cover with wax paper. Press P-50. Cook for 2 minutes; stir to move cooked eggs from outer edges to the center - do not mix whites and yolks. Press P-50. Continue cooking for 2 to 3 minutes or until yolks are set; stir once during cooking. Let stand 3 minutes.

**4 servings**

## CREAMY MACARONI AND CHEESE

- 1 cup (4 oz.) uncooked macaroni
- 1 quart hot water
- 1/2 teaspoon salt
- 2 tablespoons margarine or butter
- 1/4 cup chopped onion
- 2 tablespoons flour
- 1/2 teaspoon dry mustard
- 1/4 teaspoon salt
- 1/8 teaspoon pepper
- 1 1/4 cups milk
- 1 1/2 cups (6 oz.) shredded cheddar cheese

1. In a 2-quart glass casserole, combine macaroni, water and salt. Cook, uncovered, on P-HI for 7 minutes; stir once during cooking. Continue cooking on P-HI for 8 to 10 minutes or until macaroni is tender. Drain; rinse macaroni in a colander with hot water.
2. Heat margarine in same casserole for 30 to 40 seconds or until melted. Add onion. Cook, uncovered, on P-HI for 1 minute or until onion is tender.
3. Add flour, mustard, salt and pepper. Gradually stir in milk. Cook, uncovered, on P-HI for 7 to 8 minutes or until sauce boils and thickens; stir after each minute. Stir in cheese. Continue cooking on P-HI for 1 minute.
4. Add macaroni to cheese sauce; mix well. Cook, uncovered, on P-HI for 4 minutes or until heated thoroughly; stir once during cooking. Let stand 1 minute.

**4 servings**

## CHEESE SPREAD

- 1 package (8 oz.) cream cheese
- 1/2 cup green onions
- 1 cup shredded carrots
- 2 teaspoons lime juice
- 1 cup (4 oz.) shredded Monterey Jack cheese
- 4 tablespoons toasted sliced almonds

1. In a 2-quart glass casserole put cream cheese, onions, carrots and lime juice.
2. Cook, uncovered, on P-HI for 3 to 4 minutes or until cream cheese is softened. Add Monterey Jack cheese; stir until well blended.
3. Spread on bread or crackers and top with almonds.

**4 servings**

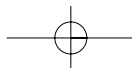

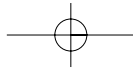

### BROCCOLI AND CAULIFLOWER SALAD

- 1 cup broccoli florets
- 1 cup cauliflower florets
- 1/2 cup mayonnaise
- 1 to 2 teaspoons prepared mustard
- 1/2 teaspoon dried basil, crushed
- 1/4 teaspoon salt

1. In a 2-quart glass casserole, combine broccoli and cauliflower
2. Cover with lid or vented plastic wrap. Cook on P-HI for 3 to 4 minutes or until vegetables are tender-crisp; cool.
3. In a small bowl, combine mayonnaise, mustard, basil and salt. Pour over vegetables; toss gently to mix.

**4 servings**

### HOT JALAPENO SALAD

- 1 1/2 cups shredded cabbage
- 1/2 cup shredded carrots
- 1/4 cup medium green bell pepper, cut into 1-inch long thin strips
- 1/2 cup sliced cherry tomatoes
- 1/4 cup sliced green onion
- 2 tablespoons fresh, chopped cilantro
- 1/4 cup Monterey Jack jalapeno cheese, cut into 1 inch cubes
- 3 oz. cream cheese, softened
- 1 tablespoon white wine vinegar

1. In a 1/2-quart glass casserole, combine cabbage, carrots, bell pepper, tomatoes, green onion and cilantro. Set aside.
2. In a 4-cup glass measure, combine cheese cubes, creamed cheese and vinegar; blend well.
3. Press P-3. Cook, uncovered, for 4 minutes; stir twice during cooking. Continue cooking on P-HI for 1 minute; stir. Let stand for 2 minutes; stir until smooth. Pour cheese over vegetable mixture; toss gently to mix.
4. Cover with vented plastic wrap. Cook on P-HI for about 3 minutes or until mixture is heated thoroughly; stir once during cooking. Let stand for 2 minutes.

**4 servings**

### CHINESE STIR-FRY

- 2 tablespoons vegetable oil
- 1 clove garlic, minced
- 1 teaspoon fresh ginger
- 1/4 cup sliced green onion
- 4 medium (or 12 small) carrots, peeled and sliced
- 1/2 cup green bell pepper, cut into strips
- 1 package (6 oz.) frozen pea pods
- 1 cup fresh bean sprouts
- 2 tablespoons soy sauce
- 1 cup sliced mushrooms

1. In a 2-quart glass casserole, combine oil, garlic, ginger and onion. Cook, uncovered, on P-HI for 1 minute. Add carrots and green pepper.
2. Cover with lid or vented plastic wrap. Continue cooking on P-HI for 3 minutes.
3. Add pea pods, bean sprouts and soy sauce, stirring to mix; cover. Continue cooking on P-HI for 2 minutes. Stir in mushrooms. Continue cooking on P-HI for 3 minutes; stir once. Let stand, covered, for 3 minutes.

**4 servings**

### WILTED SPINACH SALAD

- 6 slices bacon
- 1/4 cup bacon drippings or oil
- 1/2 pound fresh spinach leaves
- 2 tablespoons sugar
- 2 tablespoons vinegar

1. Arrange bacon on microwave rack. Cover with microwave paper towel. Cook on P-HI for 4 to 5 minutes or until bacon is crisp, rearrange once during cooking. Pour 1/4 cup bacon drippings into a 2-cup glass measure; discard any remaining drippings. Drain and crumble bacon.
2. Wash spinach leaves, pat dry and put in a serving bowl. Add sugar and vinegar to reserved drippings; stir to mix well.
3. Cook, uncovered, on P-HI for 1 minute or until boiling. Carefully stir, then pour over fresh spinach. Serve immediately.

**4 servings**

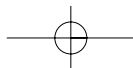



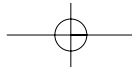

## VEGETARIAN CHILI

- 1/2 cup celery, chopped
- 1 small onion, chopped (about 1/2 cup)
- 1/2 medium green bell pepper, chopped (1/4 cup)
- 1 tablespoon chili powder
- 1 teaspoon salt
- 1/4 teaspoon crushed red pepper flakes
- 1/8 teaspoon freshly ground black pepper
- 1 can (15 1/2 oz.) mild chili beans in sauce, undrained
- 1 can (15 oz.) Great Northern beans, drained
- 1 can (15 oz.) chick peas (garbanzo beans), drained
- 2 cans (about 15 oz. each) diced tomatoes, undrained

1. In a 2-quart glass casserole, combine celery, onion and green pepper.
2. Cover with lid or vented plastic wrap. Cook on P-HI for 3 to 4 minutes or until vegetables are tender. Add chili powder, salt, red pepper and black pepper to vegetables; mix well. Stir in chili beans with sauce, Great Northern beans, chick peas and tomatoes.
3. Continue cooking on P-HI for 18 to 20 minutes or until heated thoroughly; stir once during cooking. Stir before serving.

**4 servings**

## GLAZED BABY CARROTS

- 1 pound peeled baby carrots
- 2 tablespoons butter
- 1 tablespoon brown sugar
- 1/2 teaspoon cinnamon
- Dash ground cloves

1. In a 1 1/2-quart glass casserole, combine carrots, butter, brown sugar, cinnamon and cloves.
2. Cover with lid or vented plastic wrap. Cook on P-HI for 9 to 10 minutes or until carrots are tender; stir every 2 minutes during cooking. Let stand for 3 minutes.

**4 servings**

## CANDIED SWEET POTATOES

- 2 medium sweet potatoes (about 1 1/4 lbs.)
- 2 medium tart baking apples
- 1/4 cup apple cider or juice
- 1/4 cup firmly packed brown sugar
- 1 teaspoon cinnamon
- 2 tablespoons margarine or butter
- 1/4 cup coarsely chopped pecans or walnuts

1. Wash and peel sweet potatoes and apples; slice in 1/4-inch slices. Layer slices in a 1 1/2-quart glass casserole. Pour juice over the top. In a small bowl, combine brown sugar and cinnamon; sprinkle on top; cut margarine into small pieces; place evenly on top. Sprinkle with nuts.
2. Cover with lid or vented plastic wrap. Cook on P-HI for 12 to 15 minutes or until potatoes are tender.
3. Let stand for 3 minutes.

**4 servings**

## GREEN BEANS IN CREAM SAUCE

- 1 package (10 oz.) frozen French-style green beans
- 1 can (10 3/4 oz.) condensed cream of celery soup, undiluted
- 1/2 cup sliced fresh mushrooms
- 1/4 cup milk
- 1/2 teaspoon soy sauce
- 1 can (2.8 oz.) French fried onions

1. In a 2-quart glass casserole, place green beans. Cover with lid or vented plastic wrap. Cook on P-HI for 4 to 5 minutes or until heated. Let stand, covered, for 5 minutes; drain. Stir in mushrooms, soup, milk and soy sauce.
2. Continue cooking on P-HI for 5 minutes or until heated thoroughly. Add half onions; stir. Continue cooking on P-HI for 5 minutes. Sprinkle with remaining onions. Cook, uncovered, for 1 minute. Let stand, uncovered, for 2 minutes before serving.

**4 servings**

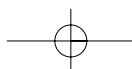

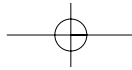

# FISH AND SEAFOOD

Delicate, tender fish is the result when cooked in the microwave. Because it is moist cooking, the finished fish and seafood, if cooked for the appropriate time, will be opaque and flake with a fork with no signs of dryness.

Because fish is unevenly shaped, the arrangement is critical to success. To arrange several fillets in a deep glass pie plate, put thicker edges to the outside and thinner edges to the inside. Try to create a circle for best results, even overlap thin ends where necessary to achieve overall even thickness.

Single items may do better if the thin ends are shielded with a foil. Some rules apply to the use of foil—Never

cover more than one-third of any item; do not let the foil pieces touch each other or the sides of the microwave oven, and be sure that all ends are tucked under and lie flat to the food. Cover with wax paper to prevent spattering.

Seafood cooks very quickly in the microwave—about 3 to 4 minutes per pound. Wait for stand time, then proceed carefully with extra time, to finish cooking without overcooking. Cooked seafood will be opaque and firm, but not tough.

## CRUMB-COATED BAKED FISH

- 1 cup seasoned bread crumbs
- 1 teaspoon dried parsley
- 1 teaspoon lemon pepper
- 1/2 cup plain yogurt
- 1 pound fresh or thawed frozen fish fillets

1. In a deep glass pie plate, combine bread crumbs, parsley and lemon pepper. Coat fish with yogurt; then coat with crumb mixture.
2. Arrange fish in an 8-inch square glass baking dish with thick edges to the outside. Cover with a wax paper with the vented corner. Cook on P-HI for 7 to 9 minutes or until fish flakes easily when tested with a fork.

**4 servings**

## FISH ROLL-UPS

- 1 package (10 oz.) frozen chopped spinach
- 1 teaspoon instant minced onion
- 2 teaspoons lemon juice
- 1/4 cup soft cream cheese
- 4 fresh fish fillets, 1/2-inch thick (about 3/4 lb.)
- 1/2 teaspoon paprika

1. Open spinach package. Place package on a paper towel. Cook on P-HI for 7 minutes. Drain spinach and place in a mixing bowl. Stir in onion and lemon juice.
2. Spread cream cheese evenly on fish fillets. Divide spinach evenly; spread over cream cheese. Roll up fish; secure with wooden picks. Place fish in a deep glass pie plate; sprinkle with paprika.
3. Cover with vented plastic wrap. Cook on P-HI for 5 to 7 minutes or until fish flakes easily when tested with a fork. Remove wooden picks.

**4 servings**

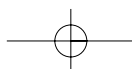

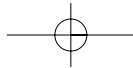

## FISH FILLET AMANDINE

- 1/4 cup margarine or butter, divided
- 1/2 cup slivered almonds
  - 1 teaspoon almond liqueur, optional
  - 1 pound fresh or thawed frozen fish fillets
  - 1 tablespoon lemon juice

1. In a 2-cup glass measure, heat 2 tablespoons margarine on P-HI for 1 minute or until melted. Add almonds. Cook, uncovered, on P-HI for 2 minutes or until almonds are lightly toasted; stir twice during cooking. Stir in liqueur if desired.
2. In an 8-inch square glass baking dish, heat 2 tablespoons margarine on P-HI for 1 minute. Place fish in baking dish, turning to toast both sides in margarine. Sprinkle with lemon juice. Cover with vented plastic wrap. Cook on P-HI for 5 to 6 minutes or until fish flakes easily when tested with a fork.
3. Top with toasted almonds.

**4 servings**

## WINE-POACHED FISH

- 1 cup dry white wine
- 1/4 teaspoon rosemary leaves, crushed
- 1/4 teaspoon salt
- 1/8 teaspoon white pepper
  - 1 pound fresh or defrosted fish fillets
  - 1/2 lemon, thinly sliced

1. In an 8-inch square glass baking dish, combine wine, rosemary, salt and pepper. Add fish, thick edges to the outside. Top with lemon slices.
2. Cover with vented plastic wrap. Cook on P-HI for 5 to 7 minutes or until fish flakes easily when tested with a fork.

**4 servings**

# COOKING FISH AND SEAFOOD

1. Arrange fish and seafood on a microwave rack (fillets, steaks, lobster) or in an appropriate glass casserole (scallops).
2. Cover with wax paper and set on glass turntable in a microwave.
3. Calculate cooking time by multiplying weight of the fish or seafood by the time recommended per pound.
4. The microwave will cook on P-HI unless another power level is entered at the time of cooking. To choose another power level, and begin cooking, press Power continuously to program the recommended power level. Press the number pad to program the calculated time. Press START.
5. Check progress about halfway through the cooking time; turn over, rearrange or shield, as needed.
6. Within several minutes before the end of cooking check fish or seafood to determine if time needs adjusting. Wait until the stand time before making the final decision.

| ITEM                              | POWER | COOK                  | STAND TIME |
|-----------------------------------|-------|-----------------------|------------|
| Fish Fillets--or--<br>Fish Steaks | P-HI  | 5-7 minutes per pound | 2 minutes  |
| Shrimp--or--<br>Scallops          | P-HI  | 3-4 minutes per pound | 2 minutes  |
| Lobster Tail                      | P-HI  | 6-8 minutes per pound | 2 minutes  |

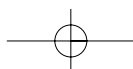

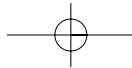

# POULTRY

Juicy and moist describes poultry cooked by microwave energy. It is a superior method for cooking chicken to be used in casseroles, salads, or to have for sandwiches. See Poached Chicken recipe.

Arrangement is very important with poultry and its uneven shapes. Try to arrange pieces in a circular pattern wherever possible for the most even defrosting or cooking. The rounded part of the drumstick should go at the outer edge, for example, while the thinner end goes to the middle of the dish. Continue with other pieces until the overall layer is fairly even. Cover with wax paper to prevent spattering.

Poultry defrosts well with our AUTO DEFROST feature. Be

sure that all poultry is completely defrosted before cooking. Check for doneness after stand time is over.

Remember that more cooking will take place during standing time. Poultry must be cooked to an internal temperature of 160°F for boneless pieces, to 170°F for bone-in pieces and to 185°F for whole birds.

Poultry is done when the meat is no longer pink and the juices are the colour of chicken broth with no traces of pink. Be sure to check for these signs by cutting into the inner thigh. You may also check for the internal temperature with an instant-read thermometer. Occasionally the bones will show red spots, but this does not affect the doneness.

## POACHED CHICKEN

- 2 bone-in chicken breast halves (about 1 lb.)
- 1 celery stalk, cut up
- 1 medium carrot, cut up
- 1 small onion, chopped (about 1/2 cup)
- 1 cup chicken broth

1. In a 2-quart casserole, place chicken breast halves. Add celery, carrot, onion and chicken broth.
2. Cover with lid or vented plastic wrap. Cook on P-HI for 12 to 15 minutes or until chicken is no longer pink and juices run clear; turn chicken over halfway through cooking. Let stand 5 minutes.

**4 servings**

## BBQ CHICKEN

- 1 broiler-fryer chicken, cut in serving pieces (2 1/2 to 3 lbs.)
- 1/2 cup catsup
- 2 tablespoons brown sugar
- 2 tablespoons vinegar
- 1 teaspoon Worcestershire sauce
- 1 teaspoon prepared mustard
- 1/2 teaspoon salt
- 1/4 teaspoon pepper

1. Rinse chicken and pat dry with paper towels. On a microwave rack, arrange chicken pieces skin side down in a single layer with thickest parts to outside.
2. In a 2-cup glass measure, combine catsup, brown sugar, vinegar, Worcestershire, mustard, salt and pepper. Reserve 1/2 cup of sauce.
3. Brush half of remaining barbecue sauce over chicken. Cover with wax paper. Cook on P-HI for 10 minutes. Rearrange and turn over chicken; brush with remaining sauce. Continue cooking on P-HI for 8 to 10 minutes or until chicken is no longer pink and juices run clear. Let stand 3 minutes. Serve with reserved sauce.

**4 servings**

## MEXICAN CHICKEN RICE CASSEROLE

- 1 pound boneless, skinless chicken breasts, cut into strips
- 1/2 teaspoon cumin
- 1/4 teaspoon salt
- 1 tablespoon margarine or butter
- 1 clove garlic, minced
- 1 cup mild or medium salsa
- 1 cup chicken broth
- 3/4 cup quick cooking rice
- 1 cup corn chips, crushed to 1/2 cup
- 1/2 cup (2 oz.) shredded Monterey Jack or cheddar cheese

1. Season chicken with cumin and salt. In a 1 1/2-quart casserole, heat margarine on P-HI for 50 to 60 seconds or until melted; stir in chicken and garlic.
2. Cook, uncovered, on P-HI for 6 to 8 minutes or until chicken is no longer pink; stir three times during cooking. Stir in salsa, chicken broth and rice.
3. Cover with lid or vented plastic wrap. Cook on P-HI for 4 to 5 minutes or until boiling. Let stand, covered, until liquid is absorbed, about 4 minutes. Stir; sprinkle with crushed corn chips and cheese.
4. Cook, uncovered, on P-HI for 1 to 1 1/2 minutes or until cheese is melted.

**4 servings**

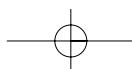

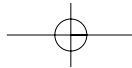

## MEATS

Tender cuts of meat do well in the microwave, especially when cooked at lower power levels. Be sure meat is fully defrosted before cooking. Consult the meat cooking charts for details.

The exact time to cook each piece of meat will depend on the shape of the meat, the weight, the starting temperature of the meat and the desired doneness. Our timings assume the meat is taken from the proper storage (refrigerated). The lower number in the time

range reflects time suggested for medium meat; the higher number for well done. It is always possible to add time if needed, so it is best to start with the lower number for calculating the time.

Stand time after cooking is an important aspect of microwave cooking since more cooking will take place then. The residual heat in the food will equalize and finish the cooking process. Always check for doneness after the stand time.

### MEATBALLS

- 1 egg, beaten
- 1/3 cup milk
- 1/4 cup quick cooking oats, uncooked
- 1/4 cup dry bread crumbs
- 1 pound lean ground meat (combination of beef and pork or turkey)
- 1 medium onion, chopped
- 1 tablespoon dried parsley flakes
- 1 teaspoon salt
- 1/4 teaspoon freshly ground black pepper

1. In a small bowl, combine egg, milk, oats and bread crumbs; let stand 2 minutes. In mixing bowl, combine ground meat, onion, parsley, salt and pepper. Add egg mixture; mix well. Form meat mixture into 24 meatballs.
2. In a 2-quart casserole, place meatballs in a single layer. Cover with wax paper. Cook on P-HI for 10 to 12 minutes or until meat is no longer pink; turn meatballs twice during cooking. Drain meatballs; let stand for 3 minutes before serving.

**4 servings**

### PEPPER STEAK

- 1 pound beef steak (flank, round or sirloin)
- 2 tablespoons white wine vinegar
- 1 tablespoon water
- 1/4 cup soy sauce
- 1 teaspoon garlic/salt
- 1/2 teaspoon sugar
- 1/4 teaspoon ground ginger
- 1 large green bell pepper, cut into strips
- 1 medium onion, sliced
- 2 medium tomatoes, peeled and quartered
- 1 cup fresh mushrooms, sliced
- 1 cup brown gravy
- Hot cooked rice

1. Slice beef across the grain into strips. In a 2-quart glass casserole, combine vinegar, water, soy sauce, garlic, salt, sugar and ground ginger. Add meat to mixture; coat each piece. Cover with lid or plastic wrap and marinate in refrigerator for 30 minutes.
2. Remove bowl from refrigerator. Stir in green bell pepper and onion; cover. Press Power pad continuously by P-80. Cook, uncovered, for 5 minutes. Stir in tomatoes and mushrooms.
3. Cover with lid or vented plastic wrap. Press Power pad by P-90. Continue cooking for 10 minutes or until meat is tender; stir once during cooking. Add brown gravy to meat mixture; stir.
4. Continue cooking on P-HI for 4 to 5 minutes or until meat mixture is thoroughly heated. Let stand for 3 minutes.

**4 servings**

#### TIP

Thin pieces of meat are no longer pink when fully cooked. Take meat from the microwave while slightly pink to prevent overcooking during standing time.

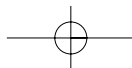

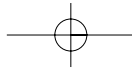

## PORK SAUSAGE CASSEROLE

- 1 medium red onion
- 3 green apples, seeded and cubed
- 2 tablespoons margarine or butter
- 1 package (12 oz.) bulk pork sausage, cooked, drained and crumbled
- 1 sweet potato (about 8 oz.) cooked, peeled and cubed
- 1 jar (12 oz.) pork gravy

1. Peel onion and cut in half. Slice it thinly. In a 2-quart glass casserole, combine onion, apples and margarine.
2. Cover with lid or vented plastic wrap. Cook on P-HI for 5 minutes, or until onions and apples are tender. Stir in sausage, sweet potato and gravy.
3. Continue cooking on P-HI for 7 to 9 minutes or until heated thoroughly.

**4 servings**

## SWEET 'N' SOUR PORK

- 1 pound boneless pork cubes
- 3/4 cup apricot preserves
- 2 tablespoons mustard
- 2 tablespoons apple cider vinegar
- 2 tablespoons light soy sauce
- 1 can (8 oz.) sliced water chestnuts, drained
- 1 can (8 oz.) pineapple chunks, drained
- 1 can (11 oz.) mandarin orange segments, drained
- 2 pounds frozen pea pods, cooked and drained
- 2 cups cooked rice
- 1/4 cup sliced almonds

1. In a 2-quart glass casserole, place pork cubes. Cover with wax paper. Cook on P-HI for 7 minutes; stir once during cooking to rearrange cooked cubes. Drain pork.
2. Stir in apricot preserves, mustard, vinegar, soy sauce, water chestnuts, pineapple, oranges and pea pods. Cook, uncovered, on P-HI for 3 minutes or until heated thoroughly. Serve over cooked rice and top with sliced almonds.

**4 servings**

## BEEF, PEPPERS AND PASTA

- 3 cups bell pepper chunks (red, yellow and green)
- 1 cup onion, sliced
- 2 tablespoons margarine or butter
- 1 1/2 cups chopped cooked beef
- 2 cups cooked elbow macaroni, drained
- 1 can (14.5 oz.) seasoned diced tomatoes, undrained
- 1 jar (14 oz.) traditional-style pasta sauce

1. In a 2-quart glass casserole, combine bell peppers, onions and margarine. Cover with lid or vented plastic wrap. Cook on P-HI for 6 to 7 minutes or until vegetables are tender.
2. Stir in beef, macaroni, tomatoes and pasta sauce. Continue cooking on P-HI for 6 to 7 minutes or until heated thoroughly.

**4 servings**

## LAMB SHEPHERD CASSEROLE

- 2 cups sliced celery
- 1 cup sliced carrots
- 2 tablespoons margarine or butter
- 2 cups cubed cooked potatoes
- 2 cups cubed cooked lamb
- 1 can (15 1/4 oz.) whole kernel corn, drained
- 1 can (10 3/4 oz.) cream of celery soup, undiluted
- 1 jar (12 oz.) onion gravy

1. In a 2-quart glass casserole, combine celery, carrots and margarine. Cover with lid or vented plastic wrap. Cook on P-HI for 6 minutes or until vegetables are tender.
2. Stir in potatoes, lamb, corn, soup and gravy. Continue cooking on P-HI for 8 to 10 minutes or until heated thoroughly.

**4 servings**

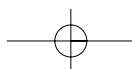

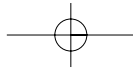

## CHICKEN RICE SOUP

Poached Chicken  
(see recipe on Page 27)  
3 cups chicken broth  
1 cup instant rice, uncooked  
2 tablespoons chopped parsley

1. Prepare Poached Chicken according to recipe. Remove chicken, cool about 10 to 15 minutes. Remove bones and cut chicken into bite-size pieces.
2. Meanwhile, add 2 cups chicken broth to poaching liquid in the medium glass casserole.
3. Cover with lid or vented plastic wrap. Cook on P-HI for 8 minutes. Stir in chicken, rice and parsley. Continue cooking, on P-HI for 5 to 6 minutes or until heated thoroughly. Let stand for 5 minutes or until rice has softened. Stir before serving.

**4 servings**

## POTATO SOUP

3 cups peeled, diced potatoes  
1/2 cup chopped onion  
1/2 cup chopped celery  
1 can (13 3/4 oz.) chicken broth  
1 can (5 oz.) evaporated skim milk  
2 teaspoons dried parsley  
1/2 teaspoon salt  
1/2 teaspoon dried thyme  
1/4 teaspoon pepper

1. In a 2-quart glass casserole, combine potatoes, onion, celery and broth.
2. Cover with lid or vented plastic wrap. Cook on P-HI for 13 to 15 minutes or until potatoes are tender.
3. Stir in evaporated milk, parsley, salt, thyme and pepper. Continue cooking on P-HI for 5 minutes or until heated thoroughly.

**4 servings**

## SAUCES AND GRAVIES

Sauces and gravies are foolproof when made in the microwave oven. Scorching, sticking, overcooking are no longer problems when the sauces are cooked in a glass measure with a handle. The sauce cooks more evenly, but it is pourable. Select a sizable utensil that is double the size of the recipe to allow for bubbling up and prevent spilling over.

It is important to stir frequently to prevent lumps, especially after mixture has boiled. A whisk is helpful to stir cooked areas into those that are not yet thickened.

Stir before serving as well.

Sauces add a nice touch of variety to menus. They can be made ahead and stored covered in the refrigerator until ready to reheat and serve. If you wish to add a sauce or gravy to cooked meats, it is best to heat the sauce fully first, then add the meat and cook for 1 to 2 minutes to heat thoroughly. This method prevents overcooking the meat.

Our versatile collection of sauces will enhance your main dishes and even desserts for creative menu planning.

## BELL PEPPER SAUCE

1 1/2 cups chopped green bell pepper  
1 1/2 cups chopped red bell pepper  
1/2 cup chopped onion  
1 teaspoon parsley flakes  
1/2 teaspoon salt  
1/2 teaspoon dried basil leaves  
1/4 teaspoon pepper

1. In a 2-quart glass measure, combine chopped bell peppers, onion, parsley, salt, basil and pepper.
2. Cook, uncovered, on P-HI for 8 to 10 minutes or until vegetables are tender; stir three times during cooking.
3. Puree vegetable mixture in blender.

**1 1/2 cups**

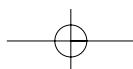

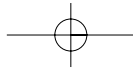

## TOMATO SAUCE

- 1 can (29 oz.) tomato sauce
- 1 teaspoon Italian seasoning
- 1 teaspoon sugar
- 1/4 teaspoon garlic powder
- 1/4 teaspoon black pepper

1. In a 2-quart glass measure, combine tomato sauce, seasoning, sugar, garlic powder and pepper.
2. Cook, uncovered, on P-HI for 8 to 10 minutes or until mixture just begins to boil; stir frequently during cooking.
3. Let stand for 2 minutes. Stir before serving.

**4 cups**

### TIP

Combine sauces with cooked meat or sausage for creative pasta toppings.

## SWEET 'N' SOUR SAUCE

- 3/4 cup apricot preserves
- 1 can (6 oz.) pineapple juice
- 2 tablespoons apple cider vinegar
- 1 tablespoon Dijon mustard
- 1 tablespoon soy sauce
- 2 tablespoons cornstarch

1. In a 4-cup glass measure, combine preserves, pineapple juice, vinegar, mustard, soy sauce and cornstarch; mix well.
2. Cook, uncovered, on P-HI for 8 to 10 minutes or until thickened; stir twice during cooking.

**1 1/2 cups**

## WHITE SAUCE

- 2 tablespoons margarine or butter
- 2 tablespoons flour
- 1/2 teaspoon salt
- 1 1/4 cups milk

1. In a 2-cup glass measure, heat margarine on P-HI for 50 to 60 seconds or until melted. Add flour and salt; stir to blend well.
2. Add milk gradually, stirring constantly. Cook, uncovered, on P-HI for 4 to 4 1/2 minutes or until mixture boils; stir every minute during cooking. Stir before serving

**1 1/4 cups**

## HERB WHITE SAUCE

- 2 tablespoons margarine or butter
- 2 tablespoons flour
- 1/2 teaspoon salt
- 1 1/4 cups milk
- 2 teaspoons each chopped fresh basil, oregano and parsley

1. In a 2-cup glass measure, heat margarine on P-HI for 50 to 60 seconds or until melted. Add flour and salt; stir to blend well.
2. Add milk gradually, stirring constantly. Cook, uncovered on P-HI for 4 to 4 1/2 minutes or until mixture boils; stir every minute during cooking.
3. Stir in herbs before serving.

**1 1/2 cups**

## CHEESE SAUCE

- 2 tablespoons margarine or butter
- 2 tablespoons flour
- 1/2 teaspoon salt
- 1/2 teaspoon dry mustard
- 1/8 teaspoon white pepper
- 1 1/4 cups milk
- 1 1/2 cups (6 oz.) shredded cheddar cheese

1. In a 2-cup glass measure, heat margarine on P-HI for 50 to 60 seconds or until melted. Add flour and salt; stir to blend well.
2. Add milk gradually, stirring constantly. Cook, uncovered, on P-HI for 4 to 4 1/2 minutes or until mixture boils; stir every minute during cooking.
3. Add cheese; stir well. Cook on P-HI for 30 seconds or until cheese is melted. Stir before serving.

**2 3/4 cups**

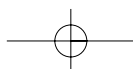



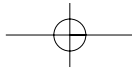

## DESSERTS

A sweet ending to a meal is a lot easier in the microwave oven. Quick to make, delicious to eat, these desserts offer something for everyone. We have selected those that do well in the microwave oven. Candies, for example, are excellent when prepared the microwave way.

To get the most even cooking, plan to make desserts in a deep glass pie plate where possible. Use a paper towel as a cover for bar cookies to equalize the cooking process. It peels off easily when done. Appearances are not what we are accustomed to seeing, but frosting or a dusting of confectioner's sugar helps create eye appeal.

Crumb pie shells do quite well in the microwave, as do most fruit desserts. To get a head start on pie fillings, simply heat in a large glass measure; stir well to distribute the heat, then pour into the prepared pie shell.

High sugar mixtures get very hot in the microwave so use great care (and hot pads) when handling.

### BROWNIES

- 2 squares unsweetened chocolate, 1oz. each
- 6 tablespoons margarine or butter
- 1 cup sugar
- 2 eggs
- 1 teaspoon vanilla
- 1 cup flour
- 1/4 teaspoon salt
- 2 tablespoons confectioner's sugar

1. In a 1 1/2-quart glass measure, put chocolate squares and margarine.
2. Cook, uncovered, on P-HI for 1 1/2 minutes; stir to finish melting chocolate.
3. Pour it in sugar, eggs and vanilla; mix well. Stir in flour and salt; mix well. Spread evenly into a deep glass pie plate. Cook, uncovered, on P-HI for 5 minutes or until no longer doughy on the bottom.
4. Let brownies stand for 15 minutes. Sift confectioner's sugar over brownies and cut into serving pieces.

**18 pieces**

### CHEESECAKE

- 1/4 cup margarine or butter
- 1 cup gingersnap crumbs
- 2 package (8 oz. each) cream cheese, softened
- 1/2 cup sugar
- 1 tablespoon fresh lemon juice
- 1/2 teaspoon vanilla extract
- 2 eggs, beaten
- Fresh fruit or canned fruit pie filling

1. In a deep glass pie plate, heat margarine on P-HI for 1 minute or until melted. Add crumbs and stir into margarine with a fork to combine. Press evenly into bottom and sides of pie plate. Cook, uncovered, on P-HI for 2 minutes. Let stand.
2. In a 2-quart glass measure, place cream cheese, sugar, lemon juice and vanilla. Add eggs; mix until well blended. Pour mixture into crust. Cook, uncovered, on P-HI for 5 minutes.
3. Shield edges with strips of foil, be certain to tuck all foil edges under. Continue cooking, uncovered, on P-HI for 2 to 3 minutes or until center is almost set. Remove foil; cool and chill thoroughly before serving.
4. Top cheesecake with fruit.

**6 servings**

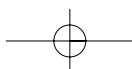

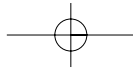

## RICE PUDDING

- 1 package (3 oz.) regular vanilla pudding and pie filling (not instant)
- 2 cups milk
- 1/2 cup instant rice, uncooked
- 1/3 cup raisins
- 1/2 teaspoon cinnamon Dash of nutmeg

1. In a 2-quart glass casserole, combine all ingredients. Cook, uncovered, on P-HI for 6 minutes or until thickened; stir three times during cooking.
2. Cover and let stand 5 minutes. Serve warm or chilled.

### **4 servings**

For a variation, substitute regular banana or coconut cream pudding and pie filling for vanilla.

## TOFFEE FUDGE

- 4 cups confectioner's sugar, sifted
- 2/3 cup unsweetened cocoa powder
- 1/4 cup milk
- 1/2 cup margarine or butter
- 1 teaspoon vanilla
- 1 cup English toffee bits or broken toffee candy

1. In a 1 1/2-quart glass casserole, blend confectioner's sugar and cocoa. Pour in milk and place margarine on top. Cook, uncovered, on P-HI for 3 minutes or until butter is melted.
2. Stir in vanilla; beat with a wooden spoon until smooth. Stir in toffee bits.
3. Pour mixture into buttered 8-inch square pan. Refrigerate at least 1 hour. Cut into squares.

### **16 squares**

## CHOCOLATE CLUSTERS

- 2 cups broken pretzels
- 1 cup miniature marshmallows
- 1 cup salted peanuts
- 1/2 cup raisins
- 3/4 cup sugar
- 1/3 cup milk
- 2 tablespoons margarine or butter
- 1 package (12 oz.) milk chocolate chips (about 2 cups)
- 1/2 teaspoon vanilla extract

1. In a large bowl, combine pretzels, marshmallows; peanuts and raisins.
2. In a 4-cup glass measure, combine sugar, milk, and margarine. Cook, uncovered, on P-HI for 3 to 4 minutes or until mixture boils; stir once during heating. Stir in chocolate chips and vanilla until chips are melted and mixture is smooth, about 2 minutes.
3. Pour chocolate mixture over pretzel mixture. Stir until well coated. Drop by tablespoonful onto wax paper-lined cookie sheet. Chill until firm.

### **3 dozen clusters**

For a variation, add other types of fruits, nuts or chocolate chips.

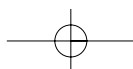

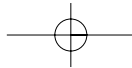

## CARE AND CLEANING

**Keep your oven clean and sweet smelling.** Opening the door a few minutes after cooking helps air out the inside. An occasional through wiping a solution of baking soda and water keeps the inside fresh.

**Don't use sharp-edged utensils on your oven.** The inside and outside oven walls can be scratched. The control panel can be damaged.

**BE CERTAIN POWER IS OFF BEFORE CLEANING ANY PART OF THIS OVEN.**

### How to Clean the Inside

**Walls and floor.** some spatters can be removed with a paper towel, others may require a damp cloth. Remove greasy spatters with a sudsy cloth, then rinse with a damp cloth. Do not use abrasive cleaners on oven walls. **NEVER USE A COMMERCIAL OVEN CLEANER ON ANY PART OF YOUR MICROWAVE OVEN.**

Door(inside). windos : Wipe up spatters daily and wash when soiled with a damp cloth. Rinse thoroughly and dry.

Metal and plastic parts on door : Wipe frequently

with a damp cloth to remove all soil. **DO NOT USE ABRASIVES, SUCH AS CLEANING POSDERS OR STEEL AND PLASTIC PADS. THEY WILL DAMAGE THE SURFACE.**

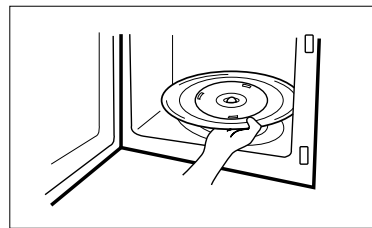

### How to Clean the Outside

**Case.** Clean the outside of your oven with soap and damp cloth, rinse with a damp cloth and then dry. Wipe the window clean with a damp cloth. Chrome trim is best wiped with a damp cloth and then with a dry towel.

**Control Panel.** Wipe with a damp cloth. Dry thoroughly. Do not use cleaning sprays, large amounts of soap and water, a brasive or sharp objects on the panel - they can damage it.

**Door Surface.** When cleaning surfaces of the door and oven that come together on closing door, use only mild, non-abrasive soaps or detergents applied with a sponge or soft cloth.'

**Power Cord.** If the cord becomes soiled, unplug and wash with a damp cloth. For stubborn spots, sudsy water may used, but be certain to rinse with a damp cloth and dry thoroughly before plugging cord into outlet.

#### ROLLER GUIDE

1. The ROLLER GUIDE and oven floor should be cleaned frequently to prevent excessive noise.
2. The ROLLER GUIDE MUST ALWAYS be used for cooking together with the Glass Tray.

#### GLASS TRAY

1. DO NOT operate the oven without the Glass Tray in place.
2. DO NOT use any other Glass Tray with this oven.
3. If Glass Tray is hot, ALLOW TO COOL before cleaning or placing it in water.
4. DO NOT cook directly on the Glass Tray.

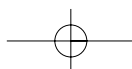
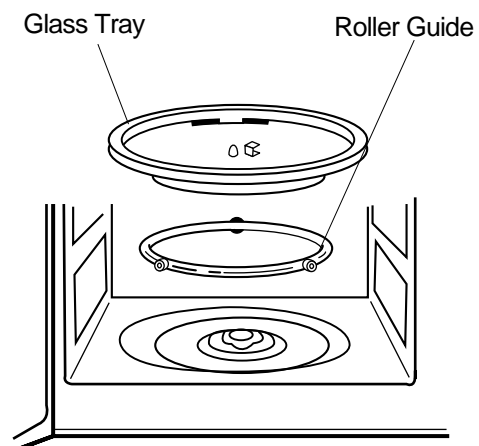

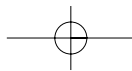

## THE EXHAUST FEATURE

The exhaust hood feature on your microwave oven is equipped with two metal filters which collect grease. When the fan is operated, air is drawn up through the filters and is then discharged through the provide venting to the outside.

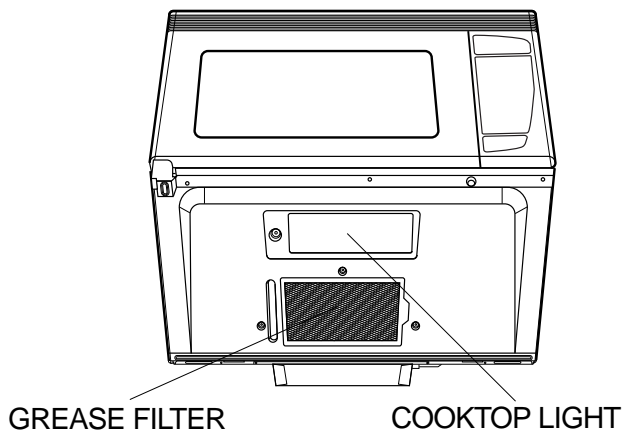

### Reusable grease filter

the grease filters should be cleaned at least once a month. Never operate the microwave without the filters in place. In situations where flaming might occur on surfaces below hood, filters will stop the entry of flames into the unit.

#### To Remove Grease Filter

To remove grease filter, grasp the "finger hold" on the filter and slide to the rear. Then pull filter downward and to the front. The filter will drop out.

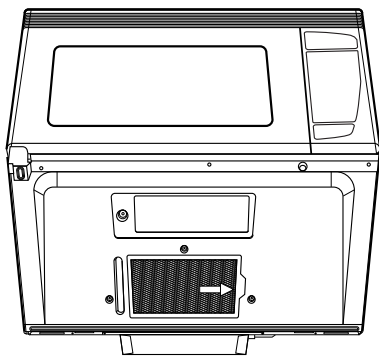

#### To Clean Grease Filter

To clean grease filter, soak it and then agitate filter in solution of hot water and detergent. Don't use ammonia or ammonia products because they will darken the metal. Light brushing can be used to remove embedded dirt. Rinse, shake and remove moisture before replacing.

To replace grease Filter, slide the filter in the frame slot on the back of the opening. Pull filter upward and to the front to lock into place.

#### To Replace Charcoal Filter

- Remove the screws on the front of the grille and remove the grille.
- Change the charcoal Filter.
- Replace the grille and screws.

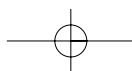
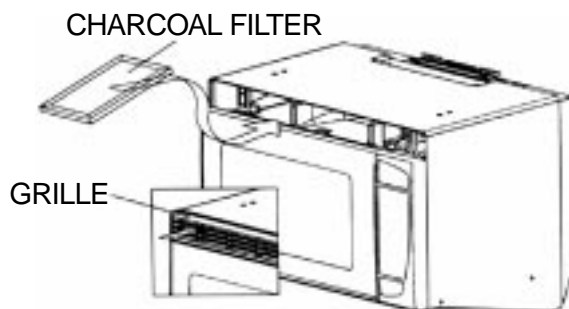

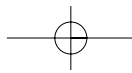

## LIGHT BULB REPLACEMENT

### Cooktop Light

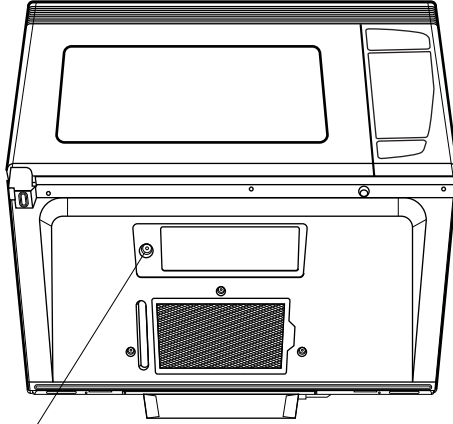

REMOVE THE SCREW

To replace the cooktop light, first **disconnect power at main fuse or circuit breaker panel or pull plug**. Remove screw on left side of light compartment cover and lower cover until it stops.

Be sure bulbs to be replaced are cool before removing. Break-the adhesive seat by gently

unscrewing the bulbs. Replace with 30-watt incandescent bulbs available from your supplier. High intensity 30-watt bulbs, which are available in supermarkets and hardware stores, may also be use for replacements. Raise light compartment cover and replace screw.

Connenct electrical power to microwave oven.

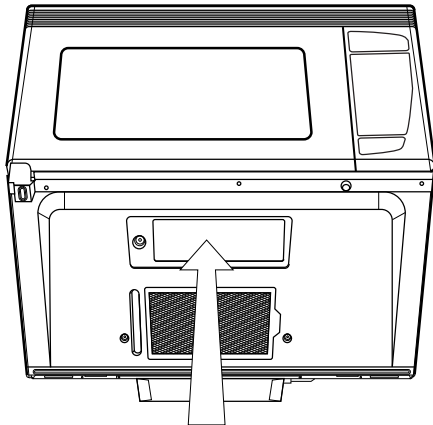

**Clean** off the grease and dust on hood surfaces often. Use a solution of warm water and detergent. About 1 tablespoon of ammonia may be added to the water. Take care not to touch the filters and enamel surfaces with this solution; ammonia will darken metal.

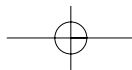

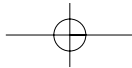

# USE YOUR MICROWAVE OVEN SAFELY

## GENERAL USE

Do not attempt to defeat or tamper with safety interlocks.

Do not place any object between the oven front frame and the door or allow residue to build up on sealing surfaces. Wipe with a mild detergent, rinse and dry. Never use abrasive powders or pads.

Do not subject the oven door to strain or weight such as a child hanging on an open door. This could cause the oven to fall forward resulting in injury to you and damage to the oven.

Do not operate the oven if door seals or sealing surfaces are damaged; or if door is bent; or if hinges are loose or broken.

Do not operate the oven empty. This will damage the oven.

Do not attempt to dry clothes, newspapers or other materials in the oven. They may catch on fire.

Do not use recycled paper products as they may contain impurities which may cause sparks or fires.

Do not hit or strike the control panel with hard objects. This can damage the oven.

## FOOD

Never use your microwave oven for HOME CANNING. The oven is not designed for proper home canning.

Improperly canned food may spoil and be dangerous to consume.

Always use the minimum recipe cooking time. It is better to undercook rather than over cook foods. Undercooked foods can be returned to the oven for more cooking. If food is overcooked, nothing can be done.

Heat small quantities of food or foods with low moisture carefully. These can quickly dry out, burn or catch on fire.

Do not heat eggs in the shell. Pressure may build up and eggs can explode.

Potatoes, apples, egg yolks and sausages are examples of food with non-porous skins. These must be pierced before cooking to prevent bursting.

Do not attempt to deep fat fry in your microwave oven.

Always stir liquids before heating. Heated liquids can erupt, if not mixed with air.

Do not pop popcorn in a paper bag unless it is the commercially prepared Microwave Popcorn product. The kernels can overheat and ignite a brown paper bag.

Do not exceed the Microwave Popcorn manufacturers' suggested popping time. Longer popping does not yield more popcorn but it can result in scorch burn or fire. Remember, the popcorn bag and tray can be too hot to handle. Remove with caution and use pot holders.

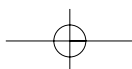

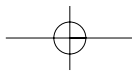

## BEFORE YOU CALL FOR SERVICE

Refer to following checklist, you may prevent an unnecessary service call.

- \* The oven doesn't work;
  1. Check that the power cord is securely plugged in.
  2. Check that the door is firmly closed.
  3. Check that the cooking time is set.
  4. Check for a blown circuit fuse or tripped main circuit breaker in your house.
- \* Sparking in the cavity;
  1. Check utensils. Metal containers or dishes with metal trim should not be used.
  2. Check that metal skewers or foil does not touch the interior walls.

If there is still a problem, contact the service station.

A list of these stations is included in the oven.

DO NOT ATTEMPT TO SERVICE THE OVEN YOURSELF!

## QUESTIONS AND ANSWERS

- \* **Q** : I accidentally ran my microwave oven without any food in it. Is it damaged?  
**A** : Running the oven empty for a short time will not damage the oven.  
However, it is not recommended.
- \* **Q** : Can the oven be used with the glass tray or roller guide removed?  
**A** : No. Both the glass tray and roller guide must always be used in the oven before cooking.
- \* **Q** : Can I open the door when the oven is operating?  
**A** : The door can be opened anytime during the cooking operation. Then microwave energy will be instantly switched off and the time setting will maintain until the door is closed and START is touched.
- \* **Q** : Why do I have moisture in my microwave oven after cooking?  
**A** : The moisture on the side of your microwave oven is normal. It is caused by steam from cooking food hitting the cool oven surface.
- \* **Q** : Does microwave energy pass through the viewing screen in the door?  
**A** : No. The metal screen bounces back the energy to the oven cavity. The holes are made to allow light to pass through. They do not let microwave energy pass through.

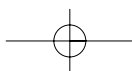

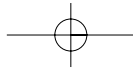

# LIMITED 1 YEAR WARRANTY

## MICROWAVE OVEN

Magic Chef warrants this microwave oven against defect in material or workmanship for a period of one year from the date of its original purchase by a consumer for home use.

## LIMITED 5 YEAR WARRANTY

For an additional four-year period beyond the first year of the general coverage of this warranty, Magic Chef will repair or replace, at its option, any magnetron tube which has failed as a result of defective material or workmanship. Labor required for such repair or replacement is not covered in this warranty.

### HOW TO OBTAIN SERVICE

In order to obtain the repair or replacement of a defective part under these warranties you must take the microwave oven to a designated service agency. You can get the name and phone number of your nearest service agent by Calling 1-800-553-4355.

### EXCLUSIONS

Magic Chef OBLIGATIONS UNDER THESE WARRANTIES SHALL NOT EXTEND TO ANY MALFUNCTION OR OTHER PROBLEM CAUSED BY:

|   |   |
|---|---|
| <ol style="list-style-type: none"> <li>1. Damage unless attributable to a defect in material or workmanship.</li> <li>2. Unreasonable use or misuse, such as, but not limited to, improper setting of controls, improper electrical supply and improper installation.</li> <li>3. Damages resulting from or problems caused by any installation, repair, alteration, modification, or adjustment of the appliance not performed by Magic Chef or by an Magic Chef authorized servicer.</li> </ol> | <p style="text-align: center;"><b>THESE WARRANTIES DO NOT COVER:</b></p> <ol style="list-style-type: none"> <li>1. The replacement of light bulbs.</li> <li>2. Microwave ovens purchased or used for commercial purposes.</li> <li>3. Cost of transporting microwave oven to the service agency.</li> </ol> |
|---|---|

### LIMITATION OF LIABILITY

In no event shall Magic Chef be liable for any incidental or consequential damages (including, but not limited to, food loss) or for any special damages or any further loss as a result of any breach of these warranties. Some states do not allow the exclusion or limitations of consequential damages; so the above limitation or exclusion may not apply to you.

### TO SECURE WARRANTY SERVICE

Before requesting service, be sure that you have read and followed all procedures in the Use and Care Book. Should service be required call 1-800-553-4355 for the name and number of your nearest service agent. Evidence of purchase date must be provided to obtain warranty service.

If you are not satisfied with the local response to you service requirements, call or write Magic Chef. The letter should include the name and address of the dealer from whom you purchased the appliance, the date of the purchase and details concerning your problem.

### ADDITIONAL RIGHTS

These warranties are the only written or expressed warranties given by Magic Chef. No one is authorized to increase, alter, or enlarge Magic Chef's responsibilities or obligations under these warranties. These warranties give you specific legal rights which may vary from state to state.

**THIS WARRANTY COVERS PRODUCTS IN THE UNITED STATES AND CANADA ONLY.**

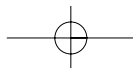



## Free Manuals Download Website

<http://myh66.com>

<http://usermanuals.us>

<http://www.somanuals.com>

<http://www.4manuals.cc>

<http://www.manual-lib.com>

<http://www.404manual.com>

<http://www.luxmanual.com>

<http://aubethermostatmanual.com>

Golf course search by state

<http://golfingnear.com>

Email search by domain

<http://emailbydomain.com>

Auto manuals search

<http://auto.somanuals.com>

TV manuals search

<http://tv.somanuals.com>