

A10-007/A10-017 A10-008/A10-018 A10-027/A10-027NZ A10-037/A10-037NZ



Stainless Steel Combination Stove & Gas Barbeque

- F** **MANUEL D'UTILISATION**
Barbecue à gaz et Réchaud en acier inoxydable
- D** **BENUTZERHANDBUCH**
Gas-Barbeque und Herd aus rostfreiem Stahl
- I** **MANUALE DEL PROPRIETARIO**
Barbecue e Forno a gas in acciaio inossidabile
- E** **MANUAL DEL COMPRADOR**
Asador y Horno de gas de acero inoxidable



IMPORTANT

Read instructions before operating. Save manual for future reference.

- F** **IMPORTANT**
Lire toutes les instructions avant utilisation.
Conserver ce manuel pour toutes consultations ultérieures.
- D** **WICHTIG**
Vor Gebrauch bitte Anleitung lesen.
Handbuch für zukünftige Hinweise aufbewahren.
- I** **IMPORTANTE**
Leggere le istruzioni prima dell'uso.
Tenere il manuale per referenza futura.
- E** **IMPORTANTE**
Leer las instrucciones antes de usar.
Guarde el manual para futuras consultas.



For questions regarding performance, assembly, operation, parts, or returns, contact the experts at MAGMA by calling TOLL FREE IN U.S.A. AND CANADA 1-800-86-MAGMA - 7:00 a.m. - 5:00 p.m. Pacific Time Monday thru Friday or e-mail us at mail@MagmaProducts.com

CE European Approval
AFNOR NO.
049 49AP198



U.S. PATENTS
4,788,962
5,330,154
5,413,090
DES. 292,163

PATENTS PENDING
AUSTRALIAN PATENT NO.
671726

Assembly Instructions

Note: Read complete instructions before operating.

F Instructions De Montage

Note: Lire complètement les instructions avant le montage.

D Anleitung Für Den Zusammenbau

Wichtig: Vor Gebrauch bitte vollständige Anleitung durchlesen.

I Istruzioni Per Il Montaggio

Nota: Leggere interamente le istruzioni prima dell'uso.

E Instrucciones De Montaje

Nota: Leer todas las instrucciones antes de usar.

Tools required

Outils nécessaires

Notwendige Werkzeuge

Strumenti necessari

Herramientas requeridas

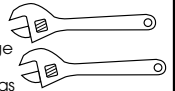

Contents

Contenu

Inhalt

Indice

Contenidos

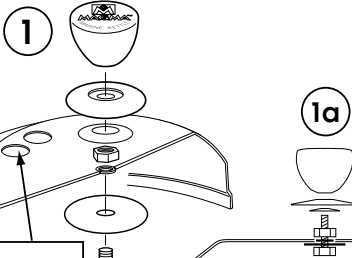
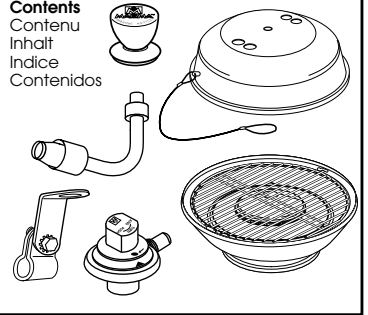

DANGER:
Never Cover Ventilation holes.

DANGER:
Ne jamais couvrir les trous de ventilation.

VORSICHT:
Zugluftöffnungen nie abdecken.

PERICOLO:
Non coprire mai i fori.

PELIGRO:
Nunca cubra los agujeros de ventilación.

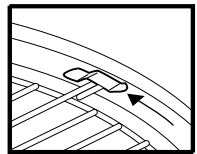
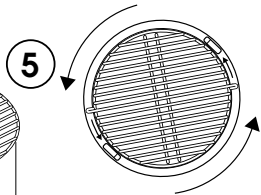
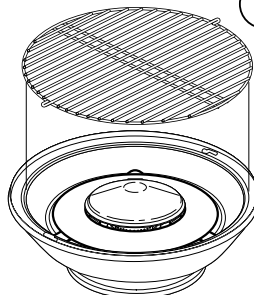
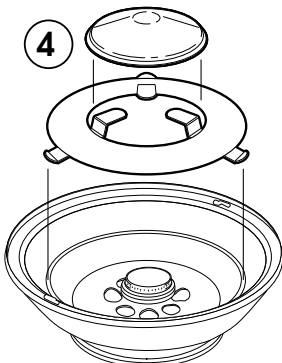
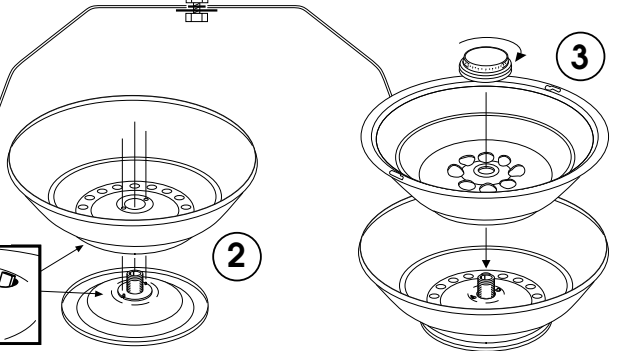
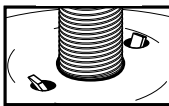

6
 ■ Adjust and tighten  with wrenches horizontally for permanent attachment.
 ➔ **CAUTION:** Do not disassemble here when stowing. (See STOWING)

■ Ajuster et serrer  horizontalement pour une fixation permanente.
 ➔ **ATTENTION:** Ne jamais le détacher à ce niveau, même lors du rangement. (Voir RANGEMENT)

■ Einstellen und für feste Installation  horizontal festziehen.
 ➔ **VORSICHT:** Zum Verstauen nicht hier auseinanderbauen. (Siehe AUFBEWAHRUNG/VERSTAUEN)

■ Aggiustare e stringere  orizzontalmente per un assemblaggio permanente.
 ➔ **ATTENZIONE:** Non smontare questo congegno quando non in uso. (Vedere CONSERVAZIONE DEL BARBECUE)

■ Ajuste y apriete  horizontalmente para una unión permanente.
 ➔ **PRECAUCIÓN:** No desarme aquí cuando lo guarde. (Ver ALMACENAMIENTO)

7

8

9

10

OFF / LOCK
 OFF / VERROUILLAGE
 AUS / GESPERRT
 SPENTO / BLOCCATO
 APAGADO / CERRADO

A10-007/A10-017

11

CAUTION: Connect in OFF position.

A10-008/A10-018

11

CAUTION: Connect in OFF position.
ATTENTION: Brancher en position OFF.
VORSICHT: Anschluß nur in AUS Position.
ATTENZIONE: Collegare in posizione SPENTO.
PRECAUCIÓN: Conecte en posición de APAGADO.

3

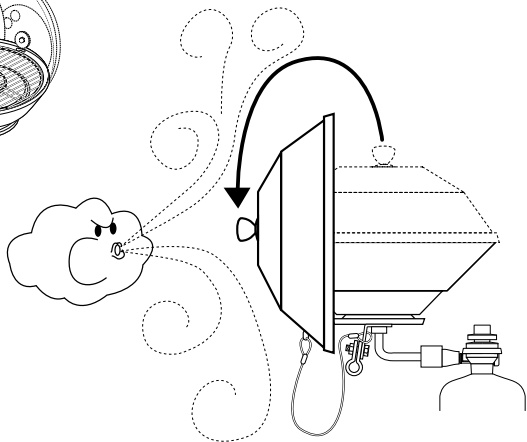
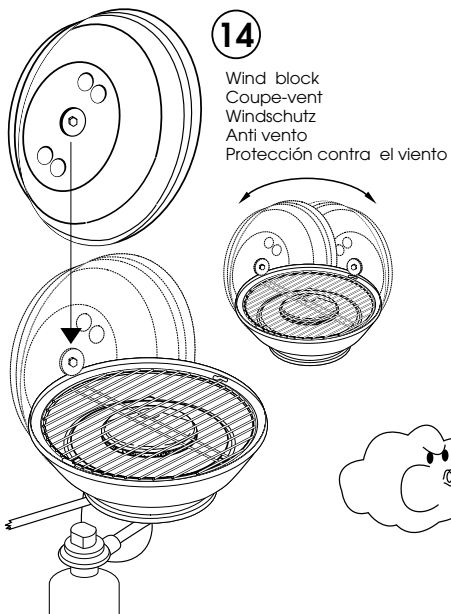
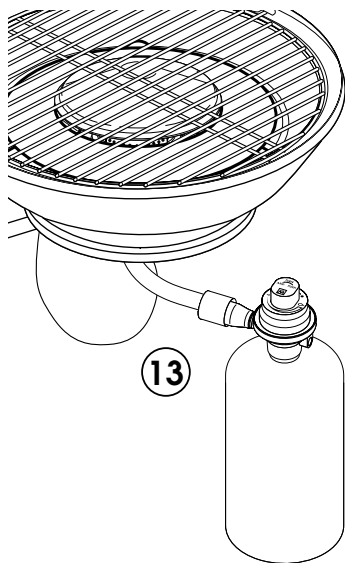
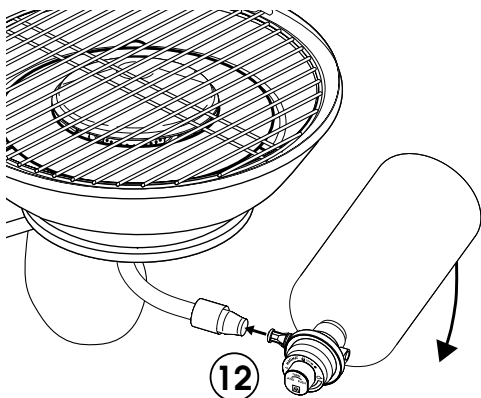

WARNING: Install cartridges in well ventilated area and away from open flame, heat source or sparks. Keep away from other people or flammable materials. See that valve sealing washer is in place and in good condition. Do not use in closed areas. Ignite only with lid off. Never store gas cartridges indoors or below decks on boats. Use CAMPING GAZ® CV-470 butane gas cartridges with model A10-008/A10-018 Gas BBQ's. Gas output 10,720 BTU (3160 W).

SAFETY

- Use outdoors in ventilated area, clearance from combustibles 24 inches (61 cm).
 - Never ignite barbeque with lid on.
 - When operating barbeque, never leave unattended.
 - Use glove or hot pad when handling hot barbeque.
 - Always keep a fresh water spray bottle handy to reduce heat & flare-ups.
 - **CAUTION: Excessive flare-ups will continue if the barbeque is too hot. To cool barbeque, spray fresh water on flare-ups until cool.**
 - Never leave gas cylinder and regulator connected when stowed.
 - Store gas cylinders in well ventilated area.
 - Use Magma #A10-210 gas cylinder storage locker.
- Do not store gas cylinders indoors, in direct sunlight, below decks on boats, or in lockers not approved for butane or propane storage.
- Do not store gas cylinders in temperatures over 120° Fahrenheit (49°Celsius).
 - **CAUTION: Check for gas leaks each time cylinder is changed by applying a soap solution to connections. If bubbles appear, repair leaks as necessary. NEVER CHECK FOR GAS LEAKS WITH A FLAME!**



Barbeque

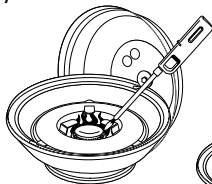
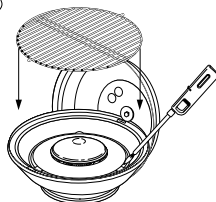

Stove



OPERATING

- **WARNING: DO NOT OVERHEAT BARBEQUE.** Stainless steel loses anti-corrosive characteristics when subjected to extreme heat causing damage and discoloration.
- Hang lid on side of barbeque to block wind. See (16)
- When igniting barbeque, use a long nozzle butane lighter.
- To ignite, turn control valve to high "large Δ " and at the same time puff flame to outer edge of radiant burner plate.
- To barbeque, cook with lid on.
- **CAUTION: A common mistake is to use too high of a heat setting.** Barbeque will continue to become hotter as you cook. Use moderate heat and be patient. To cool, spray fresh water through cooking grill and reduce flame.
- To use as a stove, remove cooking grill and radiant burner dome.

STOWING

- After barbeque is cool, follow steps (7) through (16) in reverse order and stow.
- **CAUTION: Remove barbeque from mount when stowing. Do not loosen or detach "A" to stow. See (6).**
- Stow control valve in dry atmosphere.
- **Stow cylinders as per SAFETY instructions above.**



MAINTENANCE

- Clean barbeque regularly for best performance.
- Clean all metal parts with oven cleaner per oven cleaner instructions.
- Clean all other parts with mild detergent and water.
- Lubricate all threaded areas with petroleum jelly prior to reassembly.

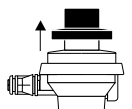

OFF / LOCK

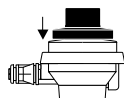

ON

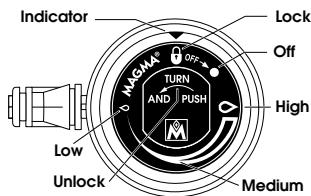

COOKING TIPS

- A common mistake is to hurry cooking times with too high of a heat setting. **The barbeque becomes hotter while cooking, so start with a low or medium heat setting until familiar with barbeque. When barbecuing, cook with lid on.**
- To reduce flare-ups, use lean cuts of meat, trim excessive fat, and avoid oil base marinades.
- If flare-ups occur, lower temperature setting, reduce heat with fresh water spray bottle, and move food away from flare-up.
- For larger cuts of meat or delicate items, use aluminum foil between food and grill to deflect direct heat.
- Lubricate cooking grill with olive oil to keep food from sticking.

Replacement parts

F Pièces de rechange
D Ersatzteile

I Pezzi di ricambio
E Piezas de repuesto

A10-080 / A10-085

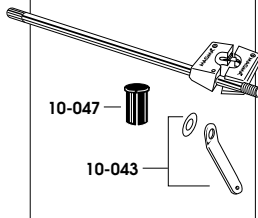

A10-240

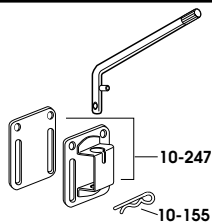

A10-120

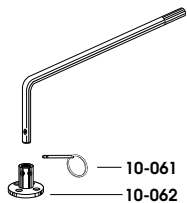

A10-650

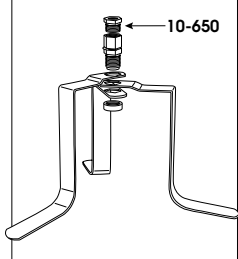

A10-007/A10-008

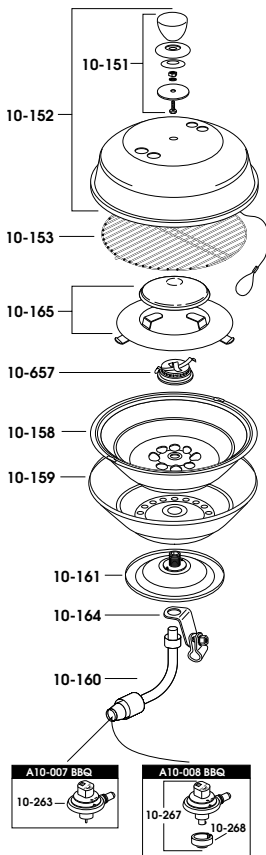

A10-017/A10-018

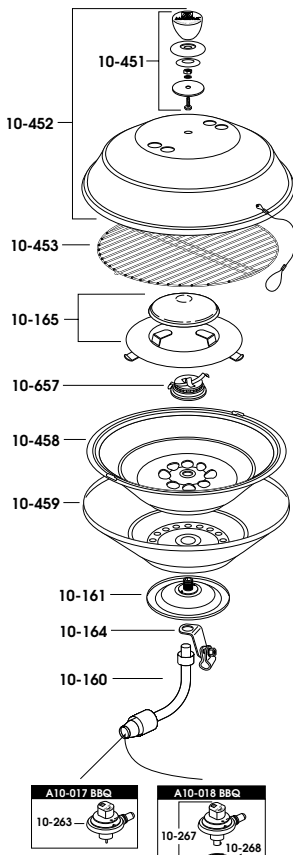

Barbeque Mounts

Round Rail Mount

A10-080 Fits Standard Size Round Rail
7/8" or 1" rails (22 mm or 25.5 mm)

A10-085 Fits Oversize Round Rail
1-1/8" or 1-1/4" rails (28.5 mm or 32 mm)

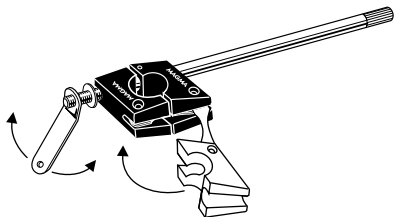

Side (Bulkhead) Mount or Square/Flat Rail Mount

A10-240

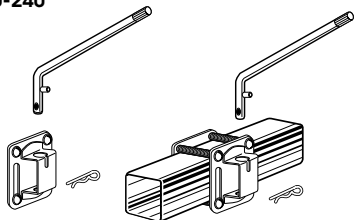

Deck Socket Mount

A10-120

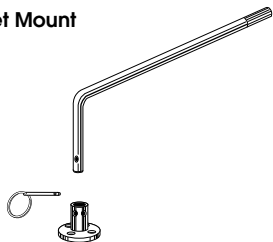

Mounting Extension

A10-140

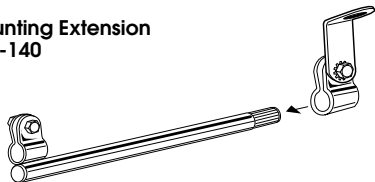

POW'R GRIP™ Fish Rod Holder Mount

A10-175

Fits 1-1/2" to 1-7/8"
inside dia. rod holders
(38 mm to 47.5 mm)

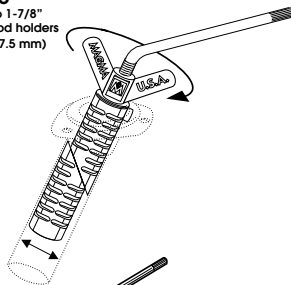

A10-160

Fits Tempress Fish-On®
Rod Holder Sockets

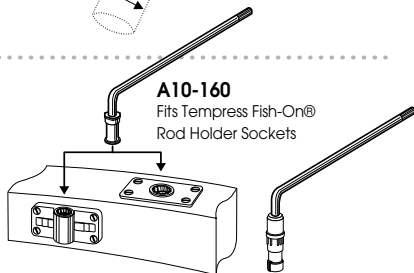

Socket Type Rod Holder Mount

A10-165

Fits Scotty®
Rod Holder Sockets

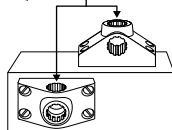

On Shore Stand

A10-650

(for all gas or charcoal
"Marine Kettle"™
barbeques)

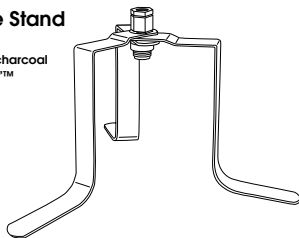

Barbeque Mount Kit for

"Dual-Mount" Tables

T10-515

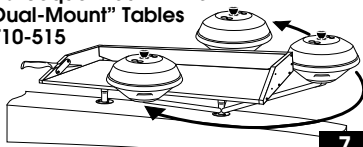

WARRANTY

All products manufactured by Magma are warranted against failures due to materials or workmanship for a period of one year from the original date of purchase (receipt required). Magma must inspect all products claimed to be defective. Magma will not be liable for products damaged due to overheating resulting from neglect or misuse by the user. Magma reserves the right to repair or replace any product. Shipping charges are users responsibility. Contact Magma first before returning any product.

CALIFORNIA PROPOSITION 65 – WARNING – The burning of gas cooking fuel generates some by-products, which are on the list of substances, which are known by the State of California to cause cancer or reproductive harm. California law requires businesses to warn customers of potential exposure to such substances. To minimize exposure to these substances, always operate this unit according to the use and care manual, ensuring you provide good ventilation when cooking with gas.



MAGMA PRODUCTS, INC.

3940 PIXIE AVENUE • LAKEWOOD, CA 90712 • USA • TEL. (562) 627-0500
e-mail: mail@MagmaProducts.com • www.MagmaProducts.com
Download from Www.Somanuals.com. All Manuals Search And Download.

Free Manuals Download Website

<http://myh66.com>

<http://usermanuals.us>

<http://www.somanuals.com>

<http://www.4manuals.cc>

<http://www.manual-lib.com>

<http://www.404manual.com>

<http://www.luxmanual.com>

<http://aubethermostatmanual.com>

Golf course search by state

<http://golfingnear.com>

Email search by domain

<http://emailbydomain.com>

Auto manuals search

<http://auto.somanuals.com>

TV manuals search

<http://tv.somanuals.com>