

MobileVision™

Owner's/Installation Manual

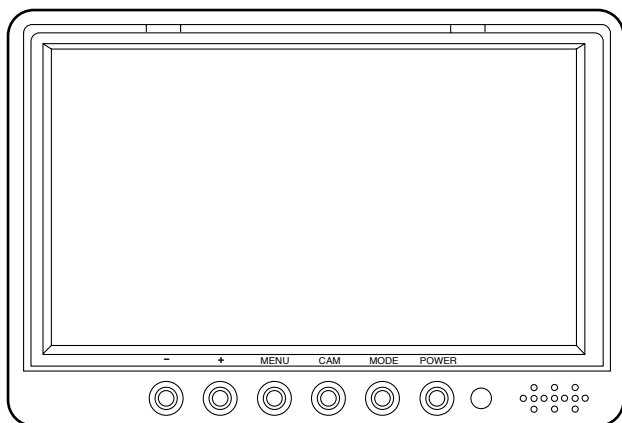

7" Color LCD Monitor

Model: M135C-4

For Technical Assistance, please call (800) 638-3600,
or visit www.magnadyne.com

Table of Contents

Introduction	2
Warning / Caution	2
Monitor Features and Controls	3
Remote Control Functions	3
General Operation	4-5
Wiring Diagram	5
Installation Instructions	6
Technical Specifications	7
Warranty	8

Introduction

Congratulations on the purchase of a quality MobileVision 7" LCD Monitor. This system has been designed to provide years of trouble free operation.

The information enclosed provides a quick reference of the operations and maintenance of the new monitor.

This product must be installed and used in accordance with this manual. Any alterations to this product that enables it to be used in any way other than intended or designed could distract the driver and result in an accident causing injury or death. Magnadyne Corporation disclaims any and all liability that may result from failure to install and operate in any other manner in which this was intended.

Warning

Backing Up Your Vehicle

Do not backup your vehicle while looking at the monitor. Always look in the direction of your vehicle's motion. Use the monitor only as an aid in safety confirmation. The actual distance may be different than it appears in the monitor. The range of the image in the monitor is limited. Always be aware that blind spots may exist and not appear at all times on your monitor.

The product is intended to assist in safe driving and allows the driver to have a broader field of vision during backup. You, as the driver, are solely responsible for the safe operation of your vehicle and the safety of your passengers and pedestrians, and for abiding of all state and local traffic regulations. Do not use any features of this system to the extent it distracts you from safe driving. Your first priority while driving should always be the safe operation of your vehicle. MobileVision will not accept any responsibility whatsoever for accidents and/or injuries resulting from failure to observe these precautions or safety instructions.

Caution

- FCC REGULATIONS STATE THAT ANY UNAUTHORIZED CHANGES OR MODIFICATIONS TO THIS EQUIPMENT MAY VOID THE USER'S AUTHORITY TO OPERATE IT.
- TO REDUCE THE RISK OF FIRE OR ELECTRIC SHOCK, DO NOT EXPOSE THIS EQUIPMENT TO RAIN OR MOISTURE.
- THIS DEVICE IS INTENDED FOR CONTINUOUS OPERATION.
- TO REDUCE THE RISK OF FIRE OR ELECTRIC SHOCK AND ANNOYING INTERFERENCE, USE ONLY THE RECOMMENDED ACCESSORIES.

Monitor Features and Controls

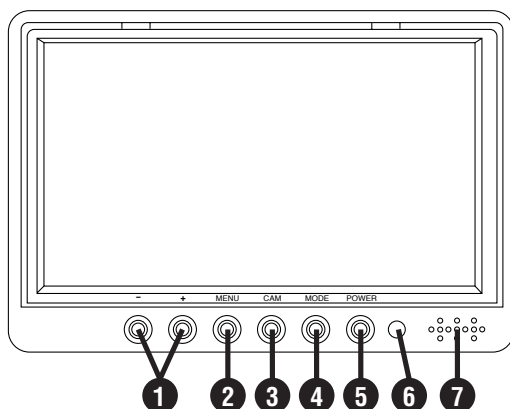

- 1. Volume Buttons (- and +):** Press to adjust the speaker's volume.
- 2. Menu Button:** Press to access the monitor's adjustment features.
- 3. Camera Selection Button (CAM):** Press to select the desired camera view: Left, Right, Front or Rear.
- 4. Camera Display Configuration Button (MODE):** Press to select different camera display configurations.
- 5. Power Button:** Press to turn the monitor on or off.
- 6. IR Sensor:** Receives signal from the remote control.
- 7. Speaker**

Remote Control Functions

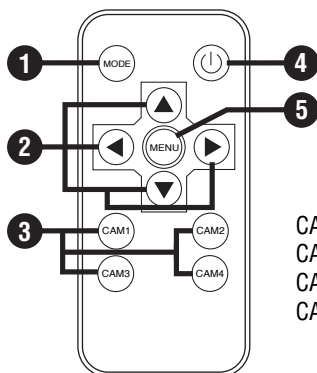

CAM 1 = Left Side Camera
CAM 2 = Right Side Camera
CAM 3 = Front Camera
CAM 4 = Rear Camera

- 1. Screen Display Selection Button (MODE):** Press to adjust the screen's camera views.
- 2. ◀, ▲, ▶ or ▼ Navigation Buttons:** Press these buttons to adjust the speaker's volume or adjust the selected menu function.
- 3. Camera(s) Display Configuration Button (MODE):** Press to select different camera display configurations.
- 4. Power Button:** Press to turn the screen on or off.
- 5. Menu Button:** Press to access the monitor's adjustment features.

General Operation

Turning the Monitor On:

The monitor is operational by activating the ignition key then manually pressing the power switch on the unit.

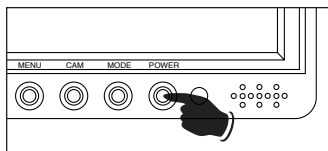

Selecting the Camera View

Press to select the desired camera view.

Note: When the camera is automatically selected (Example: the vehicle is put into reverse) the camera image will automatically override the selected camera image.

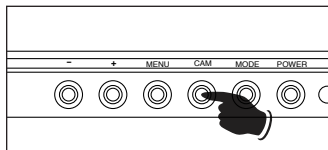

Adjusting the Speaker's Volume

Press these buttons (- or +) to adjust the speaker's volume.

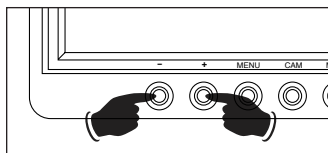

Configuring Monitor's Camera Display

Press the **MODE** to select the desired camera display configuration.

Note: When the camera is automatically selected (Example: the vehicle is put into reverse) the camera image will automatically override the selected camera display.

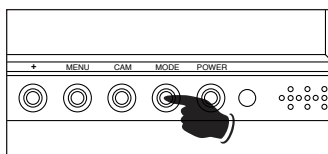

Camera Display Configurations

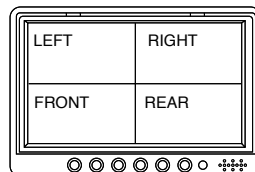
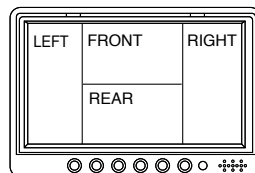
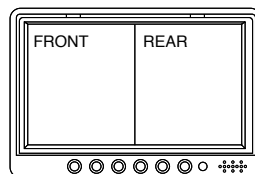
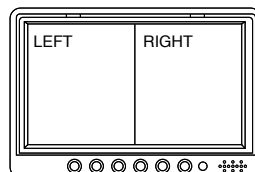

General Operation

Monitor Adjustment

To access the monitor adjustment features, press the **MENU** button. Use the - or + buttons to make adjustments to the selected function.

Menu Functions:

- Brightness
- Contrast
- Saturation
- Hue
- Volume
- Language
- Rotating ↓↑
- Rotating ⇌
- Mirror 1
- Mirror 2
- Mirror 3
- Mirror 4
- Reset

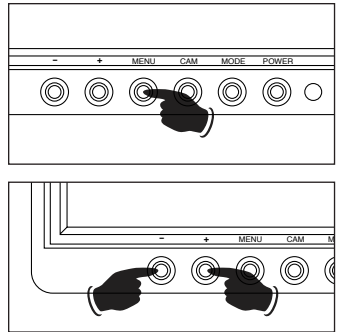

Wiring Diagram

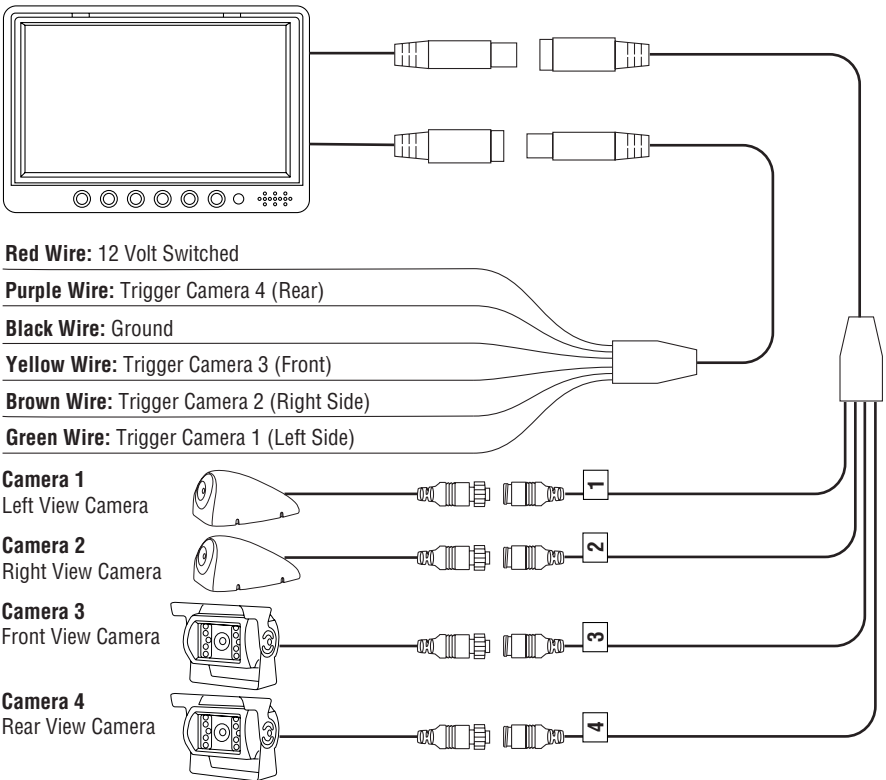

Installation Instructions

Pedestal Mounting the Monitor

1. Loosen the thumb wheel on the base support so the nut attached to the thumb wheel can slide into the monitor's mounting channel.
2. Slide the thumb wheel nut into the channel on the back of the monitor.
3. Position the monitor to the desired height and tighten the base support thumb wheel.
4. Adjust the tilt knob.
5. Use the double-sided foam (supplied) or mounting screws (not supplied) to secure the base support to the desired location.

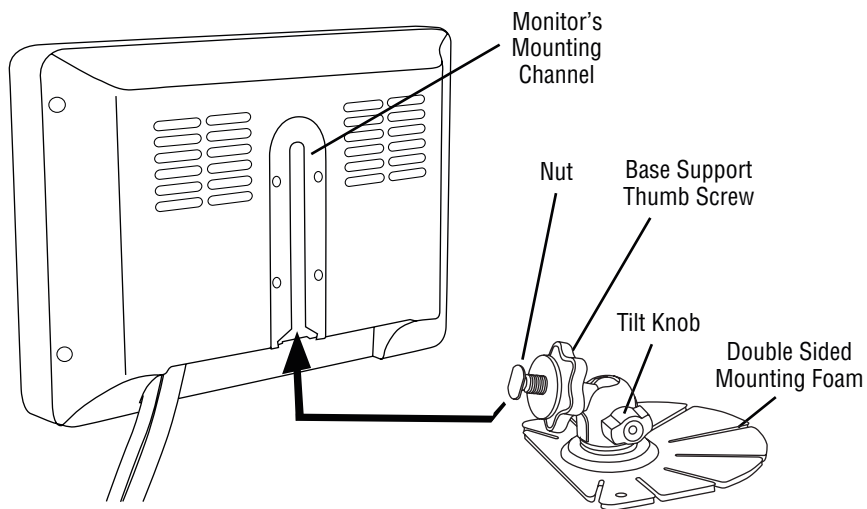

Technical Specifications

Display Size: 7-inch

Display Format: 16:9

System: PAL/NTSC

Power Supply: 12-32V

Power: 12W

Picture Resolution: 800x480

ONE (1) YEAR LIMITED WARRANTY

Magnadyne Corporation or its authorized agents will within one year from the date of sale to you, repair, replace or refund the retail sales price of said product or any part thereof, at the option of the Magnadyne Corporation or its authorized agents, if said product or part is found defective in materials or workmanship, when properly connected and operating on the correct power requirements designated for the specific product. This warranty and Magnadyne Corporation or its authorized agent's obligations hereunder do not apply where the product was; damaged while in the possession of the consumer, subjected to unreasonable or unintended use, not reasonably maintained, utilized in commercial or industrial operations, or serviced by anyone other than Magnadyne Corporation or its authorized agents, or where the warning seal on the product is broken or the power and/or plugs are detached from the unit. Magnadyne Corporation or any of its authorized agents will not assume any labor costs for the removal and reinstallation of any product found to be defective, or the cost of transportation to Magnadyne Corporation or its authorized agents. Such cost are the sole responsibility of the purchaser.

This warranty does not cover the cabinet appearance items or accessories used in connection with this product, or any damage to recording or recording tape, or any damage to the products resulting from improper installation, alteration, accident, misuse, abuse or acts of nature.

MAGNADYNE CORPORATION OR ITS AUTHORIZED AGENTS SHALL NOT BE LIABLE TO ANYONE FOR CONSEQUENTIAL OR INCIDENTAL DAMAGES OR CLAIMS EXCEPT THOSE ACCORDED BY LAW. NO EXPRESSED WARRANTY OR IMPLIED WARRANTY IS GIVEN EXCEPT THOSE SET FORTH HEREIN. NO IMPLIED WARRANTY SHALL EXTEND BEYOND ONE YEAR FROM THE DATE OF SALE.

This warranty extends only to the original purchaser of the product and is not transferable. Some states do not allow limitations on how long an implied warranty lasts, and some states do not allow the exclusion or limitation of incidental or consequential damages, so the above limitations or exclusion may not apply to you. This warranty gives you specific legal rights, and you may have other rights that vary from state to state.

“NOTE: The manufacturer is not responsible for any radio or TV interference caused by unauthorized modifications to this equipment. Such modifications could void the User's authority to operate the equipment.”

Defective merchandise should be returned to the original point of purchase or secondly, to Magnadyne Corporation, 1111 W. Victoria Street, Compton CA 90220. Return Authorization must be obtained before sending, or merchandise may be refused.

Free Manuals Download Website

<http://myh66.com>

<http://usermanuals.us>

<http://www.somanuals.com>

<http://www.4manuals.cc>

<http://www.manual-lib.com>

<http://www.404manual.com>

<http://www.luxmanual.com>

<http://aubethermostatmanual.com>

Golf course search by state

<http://golfingnear.com>

Email search by domain

<http://emailbydomain.com>

Auto manuals search

<http://auto.somanuals.com>

TV manuals search

<http://tv.somanuals.com>