

Installation and Operations Manual

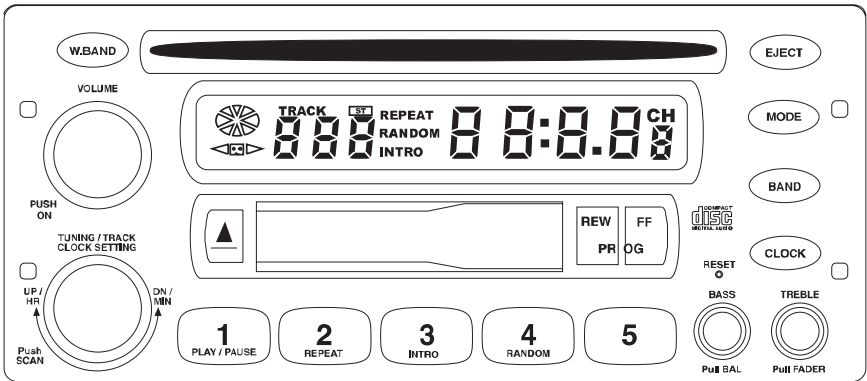

M9900 AM / FM / WB / CD and Cassette Stereo Receiver

Introduction

Your new in-dash entertainment system has been designed for many years of listening pleasure. Take a moment to read through this manual and become familiar with the operations and features of this outstanding product. This manual is broken into 4 parts. "Location and Function of the Controls at a Glance", "Operation and Programming", "Maintenance" and "Installation".

It is advisable to keep this manual in your vehicle for ready reference. We hope the experience with your new mobile entertainment system is a pleasurable one. Be sure and send in your warranty card. In the unlikely event that your system will need service during the warranty period, you will need to be registered to receive the full benefits of warranty repair.

Location and Function of Controls at a Glance

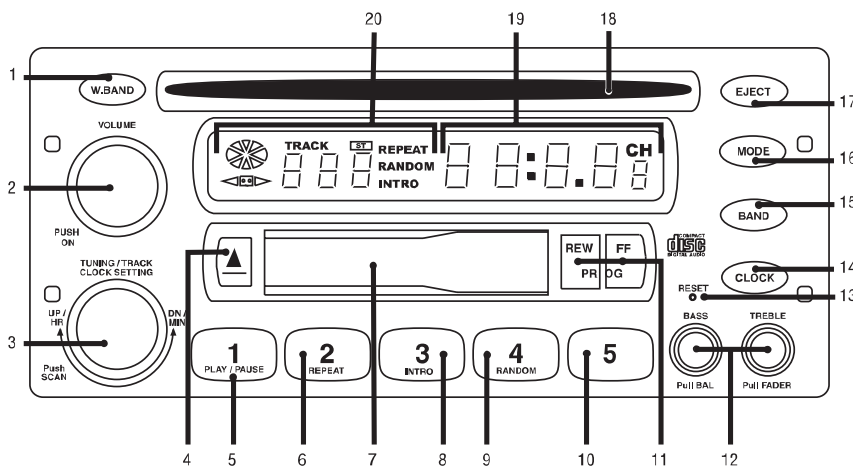

- 1. Weather Band Radio Button:** At any time when the unit is on, press this button to access the weather band radio.
- 2. On/Off/Volume Control:** Press this button to turn the unit on. Rotate the button to increase or decrease the volume level.
- 3. Multi-Function Knob:** Rotate to change radio stations. Press to scan radio stations. Rotate to adjust hours and minutes for clock setting. Rotate to change tracks when a CD is playing.
- 4. Cassette Eject Button:** When a tape is playing, press this button to eject the tape.
- 5. Multi-Function Button #1:** Press when programming a radio station into memory #1 (CH1). Press when recalling memorized radio station #1. Press to play or pause when a CD is inserted.
- 6. Multi-Function Button #2:** Press when programming a radio station into memory #2 (CH2). Press when recalling memorized radio station #2. Press to repeat a single track from the CD.
- 7. Cassette Tape Door:** Insert the cassette through this door to play the tape.
- 8. Multi-Function Button #3:** Press when programming a radio station into memory #3 (CH3). Press when recalling memorized radio station #3. Press to intro each song on the CD for 10 seconds.

Location and Function of Controls at a Glance (Continued)

- 9. Multi-Function Button #4:** Press when programming a radio station into memory #4 (CH4). Press when recalling memorized radio station #4. Press to play the songs on the CD in a different order than originally programmed.
- 10. Recall Button #5:** Press when programming a radio station into memory #5 (CH5). Press when recalling memorized radio station #5.
- 11. Tape Direction and Fast Advance Controls:** Press “REW” to fast rewind the cassette tape. Press “FF” to fast forward the cassette tape. Press both controls (REW and FF) to change the play direction of the tape.
- 12. Sound Controls:** Rotate the controls to change the BASS tone and TREBLE tone (As indicated on the panel). Pull on the controls and then rotate to adjust the “Left-to-Right” speaker balance and the “Front-to-Rear” speaker balance (As indicated on the panel).
- 13. Logic Reset Button:** If the display or front panel functions become locked and inoperative, press this button to return all logic back to “Default Mode”. Note: All clock and station recall memory will be lost.
- 14. Clock Button:** Press this button at any time, when the unit is on, will display the clock. The clock will be displayed indefinitely. If you tune to another radio station the radio frequency will be displayed for 5 seconds then will switch back to the clock. Pressing the “Clock” button a second time will display the radio frequency indefinitely. This procedure operates the same for CD and cassette modes.
- 15. Radio Band Select Button:** Press this button to select FM1, FM2, FM3, AM1, or AM2 radio bands.
- 16. Source Mode Button:** Press this button to change the play source. If a tape is loaded and a CD is loaded, and the radio is playing, you can press the “MODE” button to switch between each source.
- 17. CD Eject Button:** Press this button to eject a CD.
- 18. CD** To play a CD, insert CD into slot with label facing up.
- 19. Radio Station/ Clock Display Area:** This area will display the radio station, last pushed station recall button and the clock.
- 20. CD / Tape Function Display Area:** This area of the display shows all CD and Tape function indicators.

Listening to the Radio

1. Push the volume knob (2) once to turn the unit on.
2. Press the “BAND” button (15) to select the radio band. FM1, FM2, FM3, AM1, AM2.
3. To manually tune in a radio station, momentarily rotate the “Tuning” knob (3) right or left to advance the tuning digit by digit until the desired station is located.
4. To “Automatic Scan” to the next strong station. Press and release the “Tuning” knob (3). The tuner will scan up and wait for 5 seconds then scan up again. Once the desired station is found, press the scan button to stop the scan function.
5. To “Seek” up or down to the next station, momentarily rotate the “Tuning” knob (3) right or left and hold it for more than .5 sec then release it.

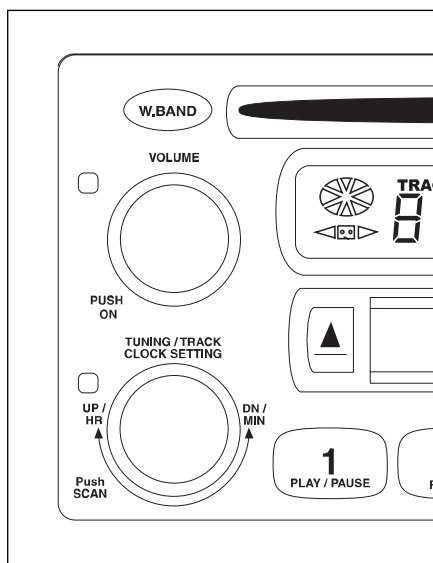

Programming the Unit

You can program up to 15 FM radio stations and 10 AM radio stations.

1. Select FM1, FM2, FM3, AM1 or AM2 by pressing the “BAND” button (15) repeatedly while watching the indication on the display (19).
2. Use the “Tuning” or “Scan” (3) button to select the desired station.
3. Press and hold one of the five station recall buttons (5-10). The button number and “CH” appears in the display area (19). Release the button.
4. Repeat the procedure to memorize more stations as desired.

Weather Band Radio Operation

1. Press the “W.BAND” button (1) to activate the weather band radio. (The weather band radio will take priority over the AM/FM Radio, CD or Tape when the “W.BAND” button is pressed). The weather band radio will search for the strongest radio signal in your area.
2. To scan all 7 weather band stations, press the “Scan” button (3)
3. Press the “W.BAND” button once again to turn off the weather band radio.

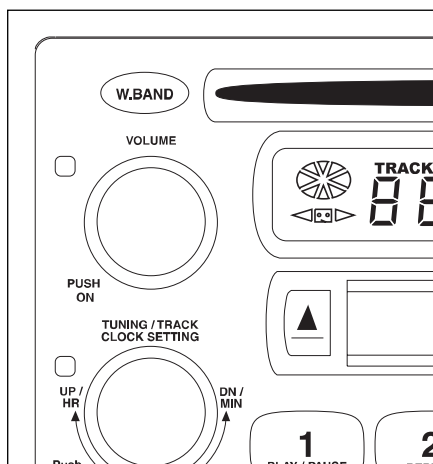

CD Operation

1. Insert a “Compact Disc” (Music) into the CD disc slot (18). The disc will auto load and auto play (The disc icon in the display (20) will begin to rotate) . If the disc does not auto load, do not force it. Press the “Eject” button (17) as you may already have a disc inserted.
2. To change the music track, rotate the “Track knob” (3) to the right or left. (See figure A) Track change indication will appear in the display area (20).
3. To “Intro” each song on the disc for 10 seconds, press the “INTRO” button (8). “Intro” will appear in the display area (20). To turn off this feature, press the “Intro” button again. The indicator in the display (20) will be off. (See Figure B)

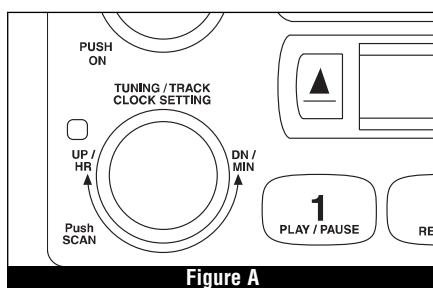

Figure A

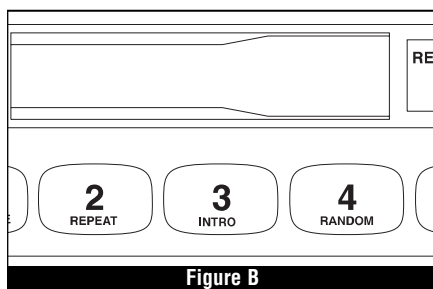

Figure B

CD Operation (Continued)

4. To play the songs on the disc in a random order (other than the original recorded order), press the "RANDOM" button (Figure C). To turn off this feature, press the "RANDOM" button again. The indicator in the display (20) will be off.
- 5A. To repeat play a single song on the CD, press the "REPEAT" button (6) one time. The "REPEAT" indicator will show in the display area (20).
- 5B. Press the "REPEAT" button (6) again to stop the repeat function. The indicator in the display (20) will be off
6. To "Pause" the playing of the disc, press the "PLAY/PAUSE" button (5) once. To resume play, press the "PLAY/PAUSE" button again (Figure D).
7. To eject the disc, press the "Eject" button (17).

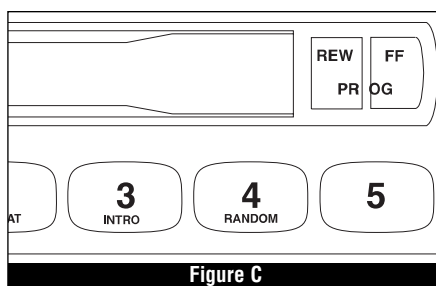

Figure C

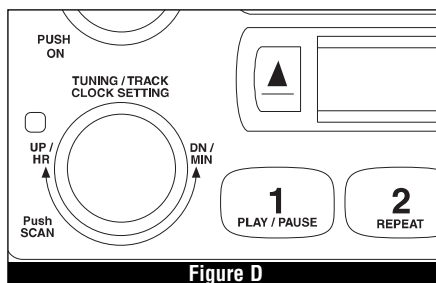
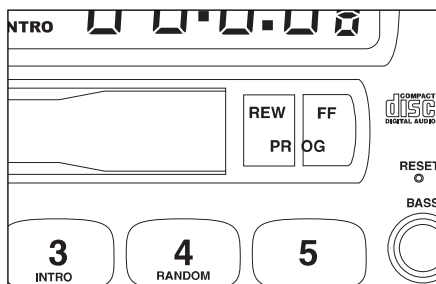

Figure D

Cassette Tape Operation

1. Insert a cassette tape into the tape slot (7). The tape can only be inserted in one direction (thick end to the right side) Do not force the tape into the slot.
2. The cassette tape indicator (20) will show the side of the tape that is playing. > indicates "Side A" and < indicates "Side B".
3. Allowing the tape to play until it's end will activate the "Auto Reverse" function. The tape will automatically change directions and the remaining side of the tape will play. To perform this function manually, press the "REW and FF" button at the same time. The < and > indicators (20) will change position.
4. To "Advance Forward" or "Rewind" the tape, press-in the "REW" button or the "FF" button (11) until it locks. To release the button, lightly press on the opposite button.
5. To eject the tape, press the "Eject" button (4) all the way in until the tape pops out.



Cassette Player Maintenance

Periodic cleaning of the tape head and drive mechanism is required to maintain reliable performance. A quality head and mechanism cleaning system can be purchased at any music store or electronics store and should be used regularly to maintain the performance and life of the tape mechanism and heads. (Follow manufactures recommendations for use and frequency of use)

Cassette Player Precautions

1. Avoid using C-120 length tape in this mechanism.
2. All time lengths up to C-90 are acceptable.
3. Check tape case before inserting the tape into the cassette slot (7).
4. Take up any slack on the tape by using a pencil in the hub to tighten the tape.

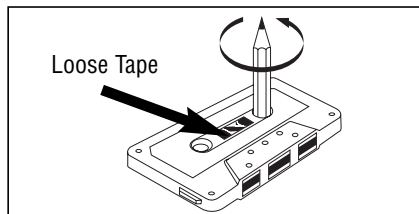

Tone and Speaker Controls

The tone and speaker controls are retractable. Pressing in on the control will lock it into a recessed position. Pressing the controls when they are in the recessed position will release them to be used to make adjustments.

Bass Control (12):

The bass control adjusts the amount of low frequency you hear in the music. Rotate the control to achieve the desired tone quality.

Balance Control (12):

Pull on the control knob (12) to activate the balance feature of the control. The balance control adjusts the sound output to the left and right speakers. Rotate the control to achieve the desired output balance between the left and right speakers.

Treble Control (12):

The treble control adjusts the amount of high frequency you hear in the music. Rotate the control to achieve the desired tone quality.

Fader Control (12):

Pull on the control knob to activate the fader feature of the control. The fader control adjusts the sound output level between the front and rear speakers. Rotate the control to achieve the desired output balance between the front and rear speakers.

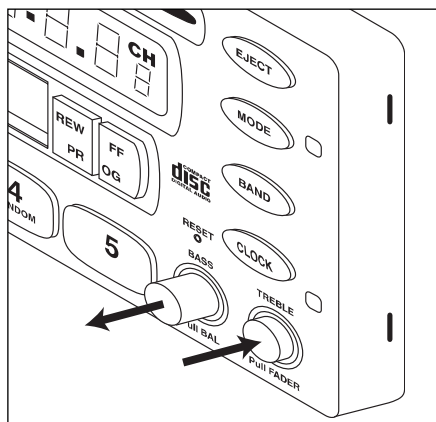
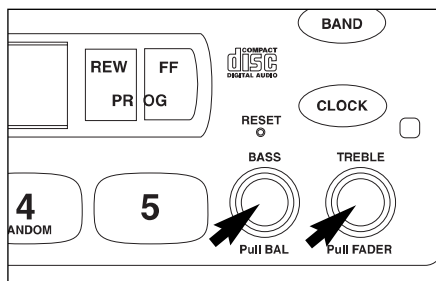

Specialty Features

Reset Button:

If by chance the function of the front panel becomes "Locked Up" (Front panel buttons don't function at all) or the display area (19) become un-readable (Broken digit segments, broken wordings etc) you can use a pencil or pen to press the "Reset" button.

Pressing the reset button clears all memory and resets the display to it's DEFAULT settings. After pressing the "Reset button" (13) all station recall buttons will lose their programming and the clock will lose the correct time. All these functions will have to be re-programmed.

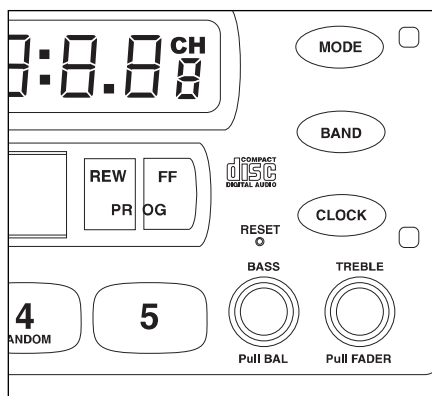

Mode Button:

The "MODE" button (16) is used to select between the sound sources (Radio, Tape or CD) when more than one source is active at one time.

Example:

If a CD has been inserted and a tape has been inserted, repeated pressing of the "Mode" button (16) will change the sound output from one source to another (Radio, Tape or CD). The source that is playing will be indicated in the display area (20).

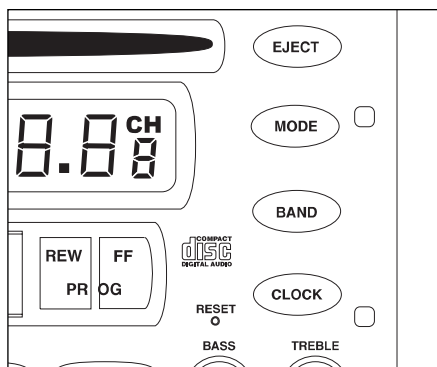

Specialty Features (Continued)

Clock Button:

Press this button at any time, when the unit is on, will display the clock. The clock will be displayed indefinitely. If you tune to another radio station the radio frequency will be displayed for 5 seconds then will switch back to the clock. Pressing the "Clock" button a second time will display the radio frequency indefinitely. This procedure operates the same for CD and cassette modes.

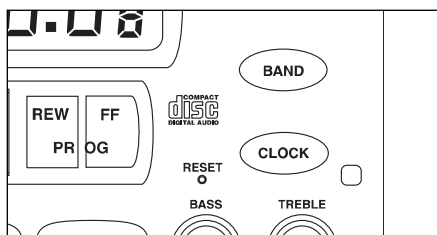

Setting the Clock:

To set the clock, press the "Volume" button (2) to turn the unit on and repeat the following procedure.

1. Press and hold the "CLOCK" button (14) until the display begins to flash.
2. Use the "Tuning/Track" button to adjust the hours (When selecting hours note the AM or PM indicator) and minutes as indicated on the control (rotate left to adjust minutes and rotate right to adjust hours).

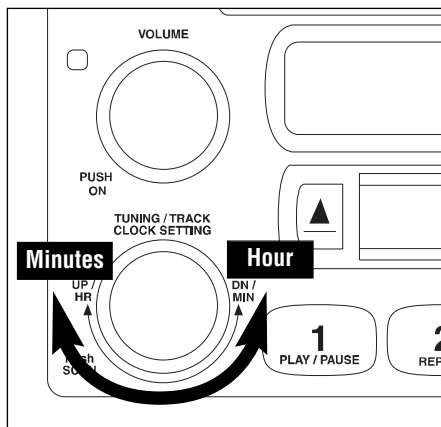
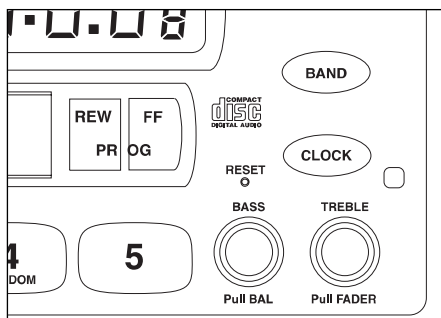

Installation Procedure

Step 1: The radio chassis is designed to be “Sleeve Mounted” through a opening in the dashboard panel. The required opening size is 182mm (7 3/16”) x 84mm (3 5/16”). Cut or engage an opening in the dashboard to accommodate the mounting sleeve.

Step 2: If you are replacing an existing factory installed radio, adapter harnesses might be available for your vehicle to eliminate the need for cutting your factory wiring. Contact Radio Shack or other car stereo installation centers for the availability of these harnesses for your vehicle.

Step 3: Insert the mounting sleeve into the hole in the dashboard. Bend the metal tabs on the sleeve to secure the mounting sleeve to the dashboard.

Step 4: Bring all wiring for the connection of the unit (including the antenna) through the center of the mounting sleeve. Connect the wiring as follows:

Yellow Wire (W/ Fuse): Connect this wire to a constant +12 volt power source (A power source that is not controlled by the ignition key).

Orange Wire: Connect this wire to the factory (+) dashboard lighting circuit that is controlled by the the headlight switch or dashboard light illumination control switch (Dimmer control). If no dashboard lighting circuit is available, connect this wire to the BLUE wire provided on this harness. Note: if this wire is not connected , the panel lighting on this unit will not light.

Red Wire: Connect this wire to a switched +12 volt power source (A power source turned on and off by the ignition key).

Blue Wire: Connect this wire to the (+) power antenna activation circuit. If no power antenna exists, tape off the end of this wire. This connection to prevent shorting out of the unit.

Note: this wire can also be used to activate the panel lighting on this unit if no dashboard lighting circuit is available. (See information for orange wire connection).

Black Wire: Connect this wire to the frame of the vehicle (Ground). This wire is the chassis grounding wire for the unit.

White wire: Connect this wire to the Left Front Speaker (+) positive terminal or wire.

White Wire with Black Stripe: Connect this wire to the Left Front Speaker (-) negative terminal or wire.

Green Wire with Black Stripe: Connect this wire to the Left Rear Speaker (-) negative terminal or wire.

Green Wire: Connect this wire to the Left Rear Speaker (+) positive terminal or wire.

Gray wire: Connect this wire to the Right Front Speaker (+) positive terminal or wire.

Gray Wire with Black Stripe: Connect this wire to the Right Front Speaker (-) negative terminal or wire.

Violet Wire with Black Stripe: Connect this wire to the Right Rear Speaker (-) negative terminal or wire.

Violet Wire: Connect this wire to the Right Rear Speaker (+) positive terminal or wire.

Note: This unit is designed to connect to (4) four speakers. If the installation only requires (2) two speakers , use the White and Gray wire sets to connect the speakers.

WARNING !

Any wires left un-connected must be taped off or capped off to prevent shorting.

DO NOT! connect speaker ground wires together.

DO NOT! connect speaker ground wires to the chassis of the vehicle.

DO NOT! connect front and rear speaker wires together.

FAILURE TO FOLLOW ANY OF THESE WARNINGS WILL RESULT IN DAMAGE TO THIS UNIT AND IS NOT COVERED BY ANY WARRANTY.

Installation

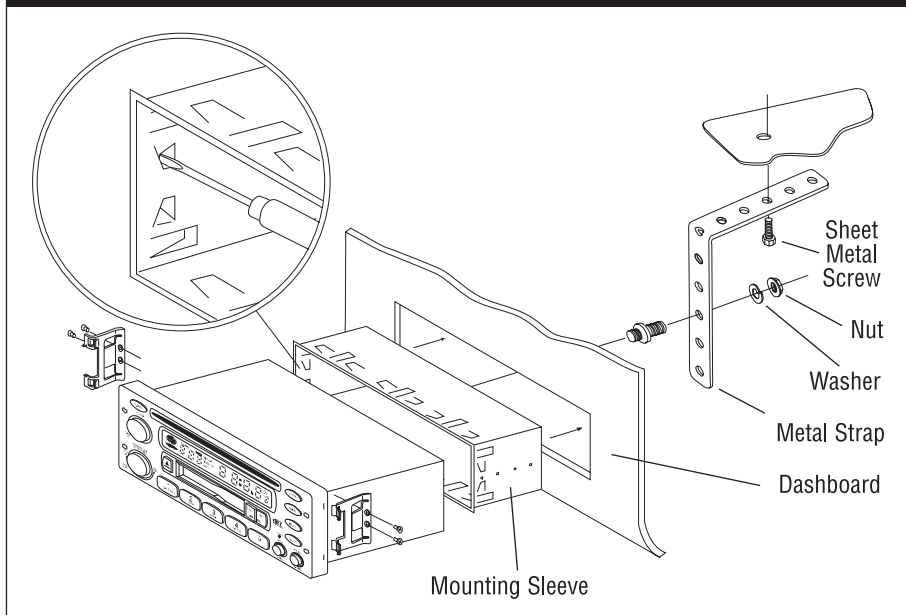

Speaker Connection

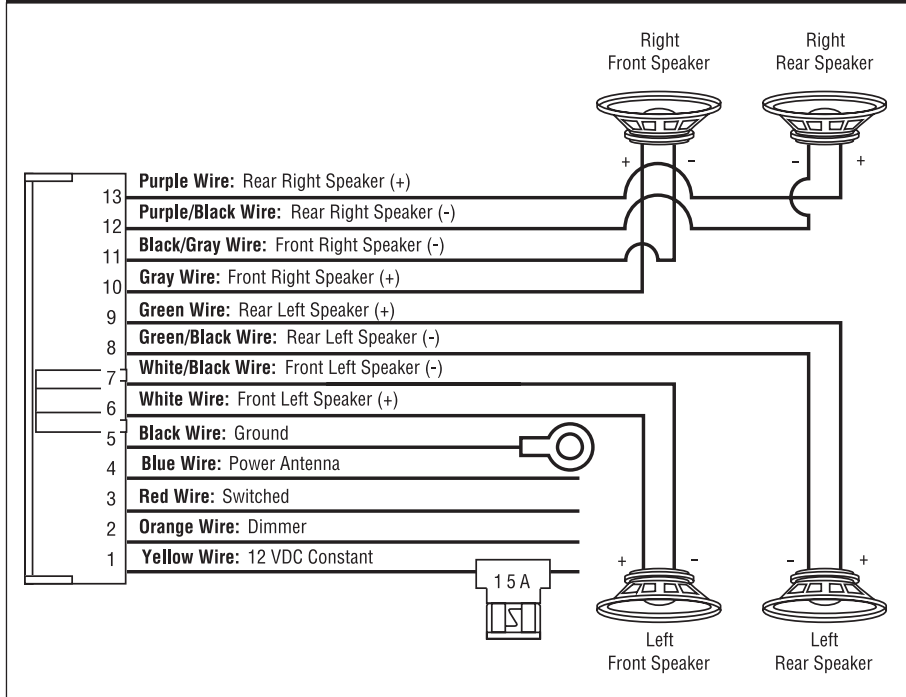

Warranty

ONE (1) YEAR LIMITED WARRANTY

Magnadyne Corporation or its authorized agents will within 1 year from the date of sale to you, repair, replace or refund the retail sales price of said product or any part thereof, at the option of the Magnadyne Corporation or its authorized agents, if said product or part is found defective in materials or workmanship, when properly connected and operating on the correct power requirements designated for the specific product. This warranty and Magnadyne Corporation or its authorized agents obligations hereunder do not apply where the product was; damaged while in the possession of the consumer, subjected to unreasonable or unintended use, not reasonably maintained, utilized in commercial or industrial operations, or serviced by anyone other than Magnadyne Corporation or its authorized agents, or where the warning seal on the product is broken or the power and/or plugs are detached from the unit. Magnadyne Corporation or any of its authorized agents will not assume any labor costs for the removal and re-installation of any product found to be defective, or the cost of transportation to Magnadyne Corporation or its authorized agents. Such cost are the sole responsibility of the purchaser.

This warranty does not cover the cabinet appearance items or accessories used in connection with this product, or any damage to recording or recording tape, or any damage to the products resulting from improper installation, alteration, accident, misuse, abuse or acts of nature.

MAGNADYNE CORPORATION OR ITS AUTHORIZED AGENTS SHALL NOT BE LIABLE TO ANYONE FOR CONSEQUENTIAL OR INCIDENTAL DAMAGES OR CLAIMS EXCEPT THOSE ACCORDED BY LAW. NO EXPRESSED WARRANTY OR IMPLIED WARRANTY IS GIVEN EXCEPT THOSE SET FORTH HEREIN. NO IMPLIED WARRANTY SHALL EXTEND BEYOND 1 YEAR FROM THE DATE OF SALE.

This warranty extends only to the original purchaser of the product and is not transferable. Some states do not allow limitations on how long an implied warranty lasts, and some states do not allow the exclusion or limitation of incidental or consequential damages, so the above limitations or exclusion may not apply to you. This warranty gives you specific legal rights, and you may have other rights that vary from state to state.

Defective merchandise should be returned to the original point of purchase or secondly, to Magnadyne Corporation, 1111 W. Victoria Street, Compton CA 90220.

Return Authorization must be obtained before sending, or merchandise may be refused.

Free Manuals Download Website

<http://myh66.com>

<http://usermanuals.us>

<http://www.somanuals.com>

<http://www.4manuals.cc>

<http://www.manual-lib.com>

<http://www.404manual.com>

<http://www.luxmanual.com>

<http://aubethermostatmanual.com>

Golf course search by state

<http://golfingnear.com>

Email search by domain

<http://emailbydomain.com>

Auto manuals search

<http://auto.somanuals.com>

TV manuals search

<http://tv.somanuals.com>