

Operation and Installation Manual

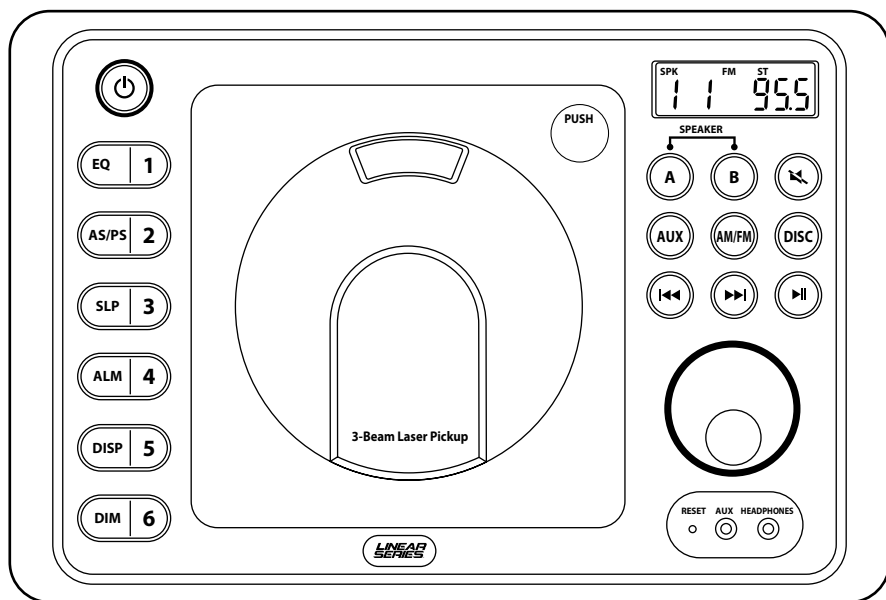

RV4000 AM/FM Stereo Multi-Media Receiver

Introduction

Please take the time to read all of the information in this manual. Familiarity with operation and installation procedures will help you obtain the best possible performance from your new AM/FM Stereo Multi-Media Receiver.

WARNING! To prevent fire or electrical shock hazard, do not expose this product to moisture, or remove cover or bottom screws. No user-serviceable parts inside. Refer servicing to qualified personnel.

Index

Button Locations and Functions	3-4
General Operation	5
Sound Controls	5-7
Speaker Selection	7
Setting the Clock	7-8
Sleep Timer Operation	8
Alarm Operation	9
Radio Operations	10-11
Disc Warnings	11
Music Disc Operation	12-13
MP3 Disc Operation	14-15
Audio Input	16
Headphone Output	16
Reset Button	17
Additional Feature	17
Installation	18
Speaker Connections	19
Wiring and Auxiliary Connections	20
Safety Instructions	21
Warranty	22

Button Locations and Functions

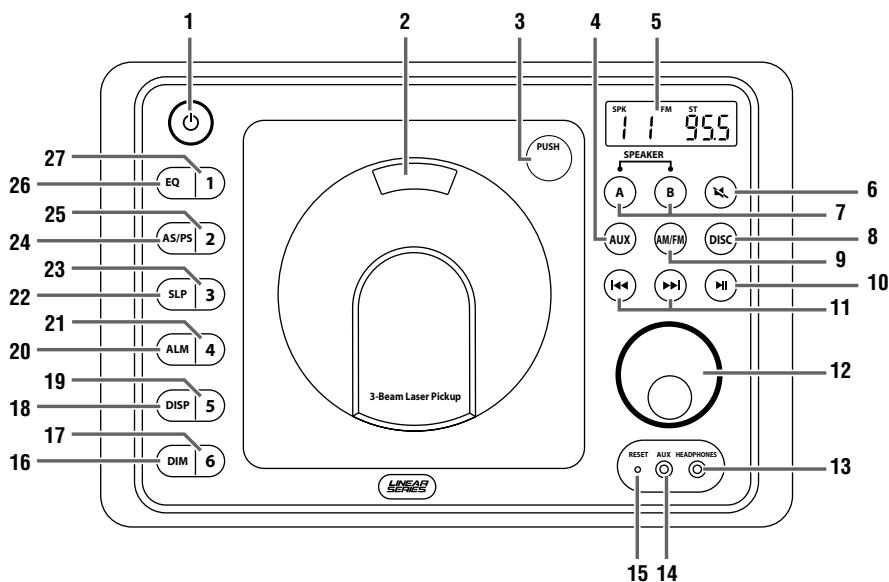

1. **Power On/Off:** Press to turn the unit on or off.
2. **Disc Door:** To play a disc, insert the disc with label facing forward.
3. **Disc Door Release:** Press to open the door so the disc can be inserted.
4. **Auxiliary Button (AUX):** Press to choose auxiliary audio in mode.
5. **Display Area:** This area displays all function information for the radio, clock, disc player and auxiliary input device.
6. **Mute Button:** Press to mute the audio, press again to restore the audio.
7. **Speaker Selection Buttons:** Press to switch the speakers sets A and B on and off.
8. **Disc Button:** Press to select the music player mode.
9. **Radio Button (AM/FM):** Press to select the radio mode. Sequential presses will select radio band: FM 1, FM 2, FM 3, AM 1 and AM 2.
10. **Play/Pause Button (▶||):** Press to pause disc play, press again to resume play.
11. **Seek Down (◀◀), Seek Up (▶▶) Buttons:**
 - Radio Mode:** Press to tune the radio to a lower or higher radio station.
 - Disc Mode:** Press to search for the beginning or next track.
12. **Volume and Select Button:** Rotate to increase or decrease the volume level. Press to select the sound controls: Bass, Treble and Balance.
13. **Headphone Socket:** Accepts 3.5mm stereo headphone jacks.
14. **Audio Input Jack:** Press the **AUX** button until "Audio" appears in the display then plug in a device via the 3.5mm audio input socket.
 - Note:** The RV4000 does not control the device, it just allows the audio to be played through the system.
15. **Reset Button:** Press to reset the unit to it's default settings.

Button Locations and Functions (Continued)

16. **Dimmer Button (DIM):** Press to dim the lighting in the display area. Sequential presses will select different levels of display area lighting.
17. **Radio Preset Button (6):** Recalls a memorized radio station, and programs a radio station into memory.
18. **Display Button (DISP):** Press to toggle through the available display information.
19. **Radio Preset Button (5):** Recalls a memorized radio station, and programs a radio station into memory.
20. **Alarm Button:** Sets the alarm. (See “Alarm Operation” for more details).
21. **Radio Preset Button (4):** Recalls a memorized radio station, and programs a radio station into memory.
22. **Sleep Button:** Sets the sleep timer. (See “Sleep Timer Operation” for more details).
23. **Radio Preset Button (3):** Recalls a memorized radio station, and programs a radio station into memory.
24. **Radio AS/PS Button:** Automatic radio station memory storing (AS) and Preset radio station scanning (PS). (See “AM/FM Operation” for more details).
25. **Radio Preset Button (2):** Recalls a memorized radio station, and programs a radio station into memory.
26. **EQ/LOUD Button (Equalizer and Loudness):** Press to select between the preset sound equalization settings. Press and hold the button to boost high and low tones at low volume levels (loudness).
27. **Radio Preset Button (1):** Recalls a memorized radio station, and programs a radio station into memory.

General Operations

Power On/Off:

Press the **POWER** button to turn the unit On/Off.

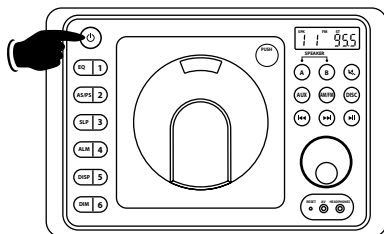

Selecting a Play Source:

To select a play source, press one of the following mode buttons:

AUX (Auxiliary Audio Input),

AM/FM (AM or FM Radio Band) or

DISC (Music)

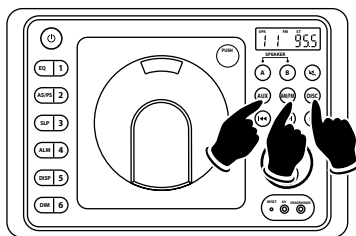

Dimming the Display:

Press the **DIM** button to select the desired level of brightness for the display area.

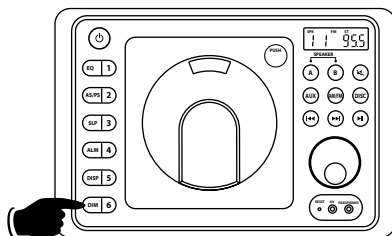

Display Selection:

Press the **DISP** button to display the clock.

Press again to return to previous display.

Press and hold to perform clock setting functions (See "Setting the Clock" for more details).

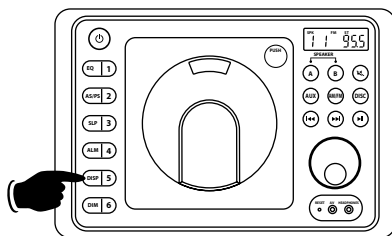

Sound Controls

Volume:

Increase the volume by rotating the **VOLUME** knob clockwise. Decrease the volume by rotating the **VOLUME** knob counterclockwise.

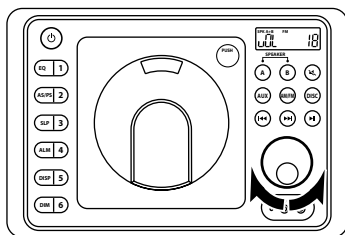

Sound Controls

Bass, Treble and Balance Control

Select the desired sound mode by pressing the **VOLUME** knob. The modes will be displayed in the following order: Bass, Treble, Balance and Volume.

Bass:

Select the Bass mode by pressing the **VOLUME** knob. Increase the Bass by rotating the **VOLUME** knob clockwise. Decrease the Bass by rotating the knob counterclockwise. After 6 seconds control reverts back to volume control.

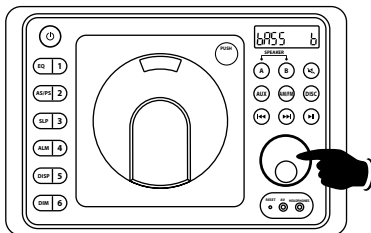

Treble:

Select the Treble mode by pressing the **VOLUME** knob. Increase the Treble by rotating the **VOLUME** knob clockwise. Decrease the Treble by rotating the knob counterclockwise. After 6 seconds control reverts back to volume control.

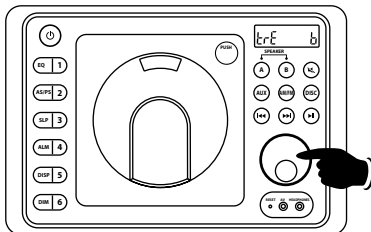

Balance:

Select the Balance mode by pressing the **VOLUME** knob. Adjust the Balance by rotating the knob.

- r - L = Equal sound right and left
- r 7 = Right speaker only
- L 7 = Left speaker only

After 6 seconds control reverts back to volume control.

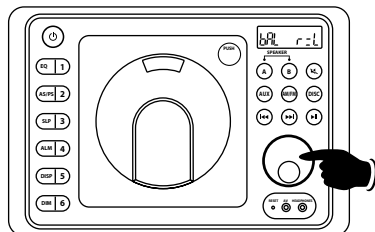

Equalizer (EQ):

Press the **EQ** button to choose between the preset equalizer settings: Flat, Classic, Rock, Pop and Jazz as indicated in the display area.

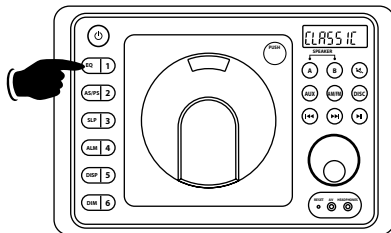

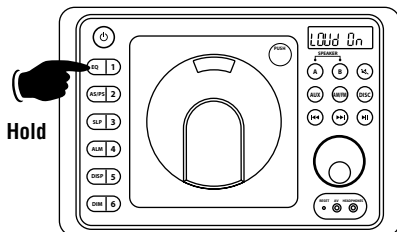

Loud:

To boost high and low tones at low volume levels, press and hold the **EQ** button until "LOUD On" appears in the display. To deselect, press and hold the **EQ** button again until "LOUD OFF" appears in the display.



Sound Controls (Continued)

Mute:

- Press the  button to mute the volume level.
- Press the  button again to restore the volume.

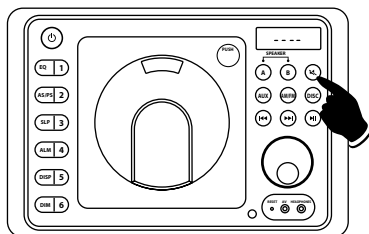

Speaker Selection

Selecting Speaker Sets:

- Press the **A** button to toggle speaker set A on and off. "SPK A" appears in the display when speaker set A is on.
- Press the **B** button to toggle speaker set B on and off. "SPK B" appears in the display when speaker set B is on.

Note: When "SPK A+B" appears in the display both speaker sets A and B are on. When nothing appears in the displaying both speaker sets are off.

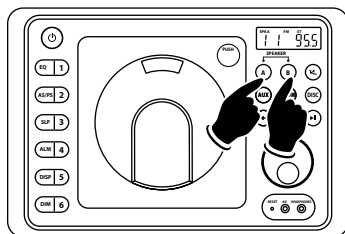

Setting the Clock

1. Press the **DISP** button until the clock appears in the display.

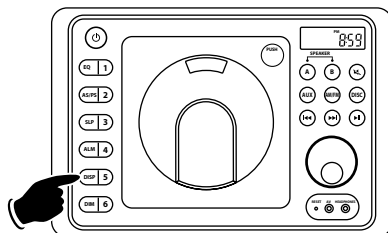

2. Press and hold the **DISP** button until the hours number starts flashing.

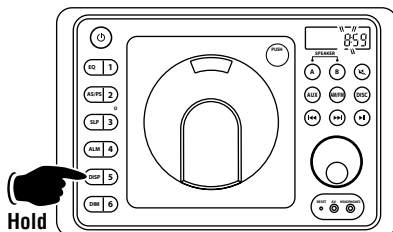

3. Rotate the **VOLUME** knob until the correct Hour appears in the display.

Note: When setting the clock make sure to select the correct AM or PM indicator.

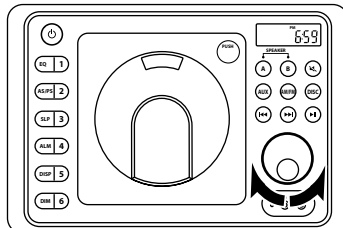

Setting the Clock (Continued)

4. Press the **VOLUME** knob and the Minute indicators will start flashing.

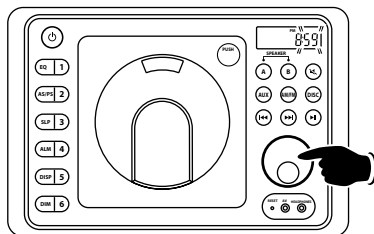

5. Rotate the **VOLUME** knob until the correct Minutes appears in the display. Wait 5 seconds and the colon between the hours and the minutes will start flashing indicating the clock is set.

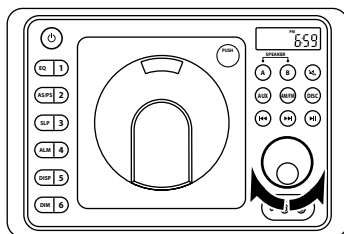

Sleep Timer Operation

Setting the Sleep Timer:

1. Press the **SLP** button until the "SLP 10" appears in the display.
2. Keep pressing the **SLP** button again until the desired sleep time appears in the display (00, 10, 20, 30, 40, 50, 60, 70, 80 minutes).
3. Wait 5 seconds and the display will return to normal operation and "SLP" will appear in the display.
4. After the designated sleep timer has expired the unit will turn off automatically.

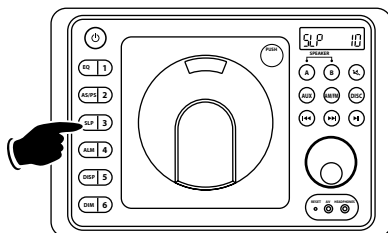

Cancelling the Sleep Timer:

1. Press the **SLP** button until "00" is displayed.
2. Wait 5 seconds and the display will return to normal operation.

Alarm Operation

Setting the Alarm Timer:

1. Press the **ALM** button and the clock will appear in the display with the hour number flashing.

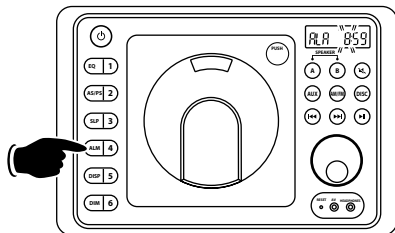

2. Rotate the **VOLUME** knob until the correct Hour appears in the display. "ALM" will appear in the display indicating the alarm is activated.

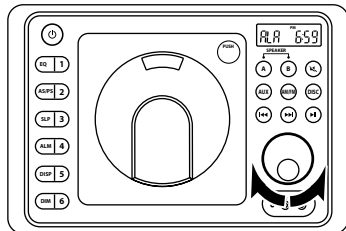

Note 1: When setting the alarm clock make sure to select the correct AM or PM indicator.

Note 2: When setting the alarm DO NOT use 12:00 AM, because that time is used to cancel the alarm.

3. Press the **VOLUME** knob and the minute indicators will start flashing.

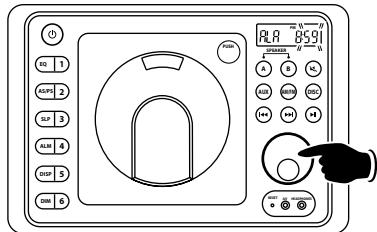

4. Rotate the **VOLUME** knob until the correct minutes appears in the display. Wait 5 seconds and the colon between the hours and the minutes will start flashing. The letter "ALM" will appear in the display indicating the alarm is set.

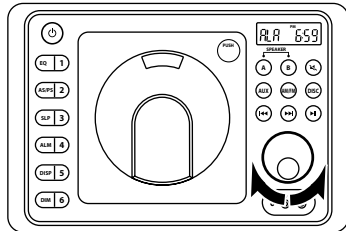

5. Press the **POWER** button to turn the unit off. The unit will automatically turn on when the set alarm time is reached.

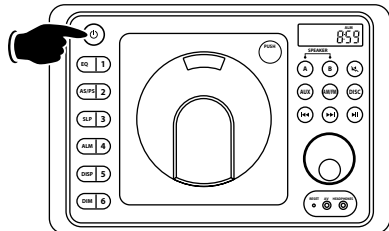

Cancelling the Alarm Timer:

Follow the procedures above except set the alarm time to 12:00 AM. When the display exits alarm timer programming the "ALM" will disappear from the display indicating the alarm has been cancelled.

Radio Operations

Selecting the Play Source:

Press the **AM/FM** button and “rAdiO” appears in the display. After a brief moment either AM or FM will appear in the display.

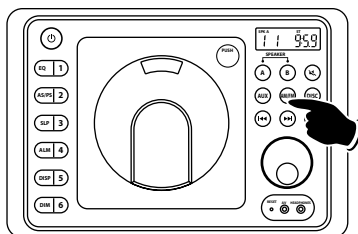

Selecting the AM or FM:

Press the **AM/FM** button repeatedly and select from FM 1, FM 2, FM 3, AM 1 or AM 2.

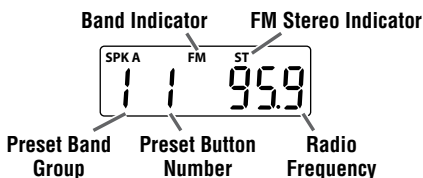

Seek Tuning in a Radio Station:

Press and release the **I◀◀** button to tune in a lower radio station. Press and release the **▶▶I** button to tune in a higher radio station.

Note: The unit will automatically switch from FM Mono to FM Stereo when the signal strength increases to a stereo level. If the stereo signal should become weak, the unit will switch back to Mono. FM stereo reception is indicated when “ST” appears in the display.

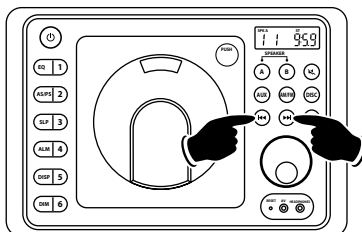

Manual Tuning in a Radio Station:

Press and hold the **I◀◀** button to manually tune in a lower radio frequency. Press and hold the **▶▶I** button to manually tune in a higher radio frequency.

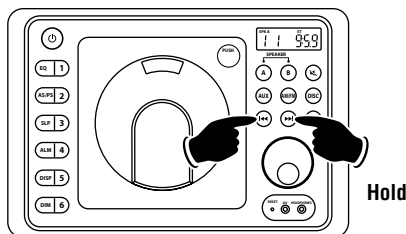

Memorizing Radio Stations:

1. Press the **AM/FM** button to select either the FM 1, FM 2, FM 3, AM 1 or AM 2 radio band.
2. Tune-in the desired radio station.
3. To memorize the station press and hold any one of the six radio station recall buttons until the preset number appears.

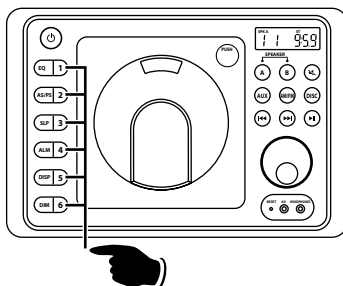

Radio Operation (Continued)

Automatically Store Radio Stations:

1. Press the **AM/FM** button to select either the FM or AM radio band.
2. Press and hold the **AS/PS** button then release. The tuner will search for the strongest stations and store them into memory. The new stations will replace stations that were previously stored in the current band.

Note: When the FM band is selected the 18 strongest stations will be stored. When AM band is selected the 12 strongest stations will be stored.

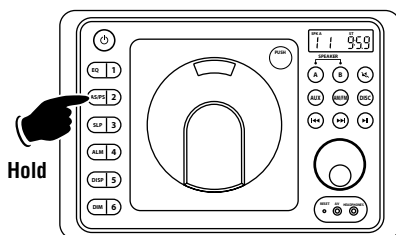

Scanning Stored Radio Stations:

1. Press the **AM/FM** button to select either the FM or AM radio band.
2. Press the **AS/PS** button then release. The tuner scans for preset stations stored in the current band and pauses for 6 seconds at each station. When a desired station is reached, press the **AS/PS** button again to stop scanning.

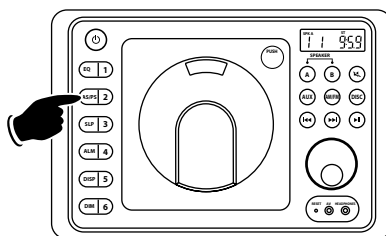

Disc Warnings

Handling and Cleaning:

- Dirt, dust, scratches and warping disc will cause non operation.
- Do not place stickers on disc or scratch disc.
- Do not warp discs.
- A disc should always be kept in its case when not in use to prevent damage.
- Do not place discs in the following places:
 1. Direct sunlight.
 2. Dirty, dusty and damp areas.
 3. Near car heaters.
 4. Car seats or dashboard.

Disc Cleaning:

Use a dry soft cloth to wipe disc the surface. If the disc is quite dirty, use a soft cloth slightly moist with isopropyl (rubbing) alcohol. Never use solvents such as benzene, thinner or conventional record cleaners as they may mar the surface of the disc.

Note: A disc may become somewhat scratched (although not enough to make it unusable) depending on handling and conditions in the usage environment.

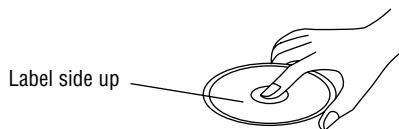

Do not touch the underside of the disc



Do not bend



Wipe the disc from the center toward the outside edge



Music Disc Operation

General Operations:

1. Push the door access the disc player.

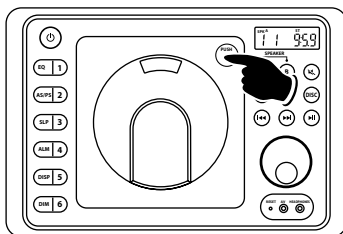

2. Insert the disc onto the hub with the label facing forward. Use your thumb to make sure the disc snaps onto the hub.



3. Press the **DISC** button and "LOAD" will appear in the display. The disc will automatically start playing.

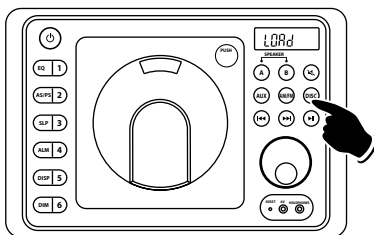

Music Track Selection:

Press the **◀◀** button to select a lower track.
Press the **▶▶** button to select a higher track.
The track number will appear in the display.

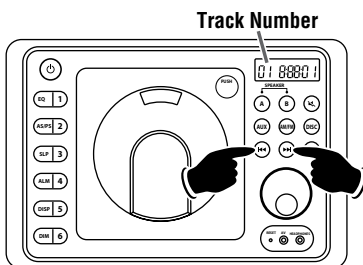

Music Disc Operation (Continued)

Pausing the Disc:

Press the ►|| button to pause the disc, press it again to resume play.

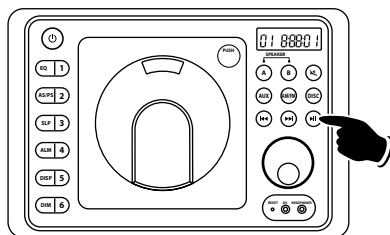

Removing the Disc:

1. Push the door to access the disc player. Wait until the disc stops spinning before opening up the door.
2. Use your finger to remove the disc from the hub.
3. Close the door.

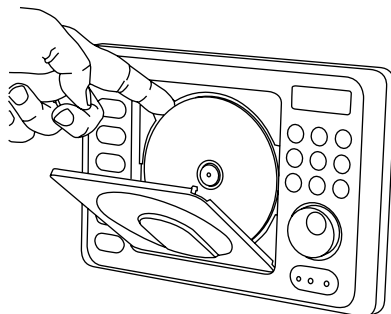

MP3 Disc Operation

General Operations:

1. Push the door access the disc player.

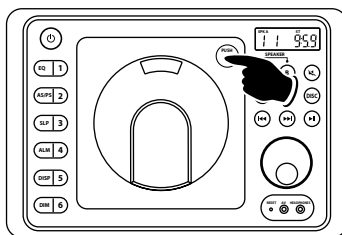

2. Insert the disc onto the hub with the label facing forward. Use your thumb to make sure the disc snaps onto the hub.



3. Press the **DISC** button and "LOAD" will appear in the display. The disc will automatically start playing.

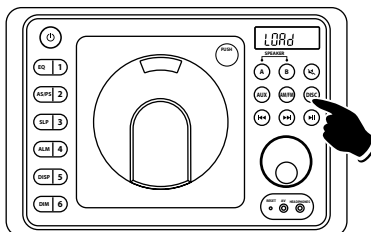

Disc File Selection:

Press the **I◀◀** button to select a lower file.

Press the **▶▶I** button to select a higher file.

The file number will appear in the display.

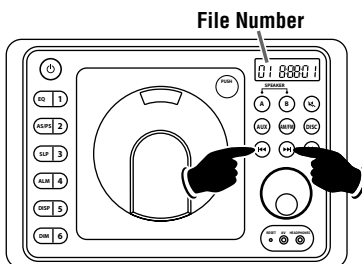

MP3 Disc Operation (Continued)

Pausing the Disc:

Press the ►|| button to pause the disc, press it again to resume play.

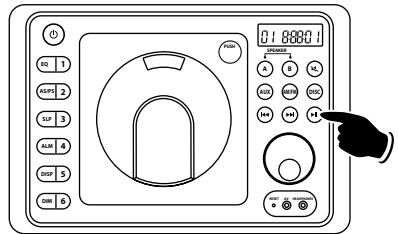

Removing the Disc:

1. Push the door to access the disc player. Wait until the disc stops spinning before opening up the door.
2. Use your finger to remove the disc from the hub.
3. Close the door.

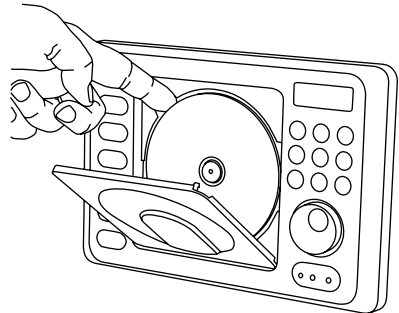

Reset Button

The LCD display may fail to function normally due to the vehicle's battery condition, and could require resetting the radio microprocessor if:

- The vehicle has been "jump started" from a dead battery condition.
- The vehicle battery becomes very low and is quick-charged.
- The vehicle battery is removed and replaced.

Should any of these conditions occur, simply press and release the **RESET** button on the radio front panel using the tip of a ball point pen. This will reset the radio microprocessor to the original factory settings. After pressing the **RESET** button you should recheck to see if the radio functions normally.

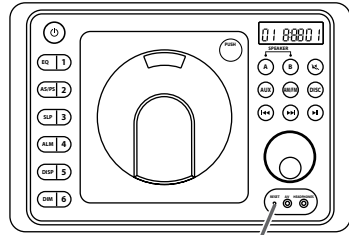

Reset Button

Additional Feature

Area Radio Frequency Adjustment:

Note: If operating the unit in the USA do not change the area.

To Change the Area:

1. Press the **AM/FM** button and "rAdIO" appears in the display.
2. Press and hold the **VOL/TONE** knob until "SEtUP" appears in the display.
3. Press the **▶||** button and "US" or "OCEAn" will be displayed.
4. Press the **◀◀** or **▶▶** button to change the setting to "US" or "OCEAn".
5. Press the **▶||** button to save the setting. The unit will clear all the station settings. After waiting a few seconds the unit exit programming.

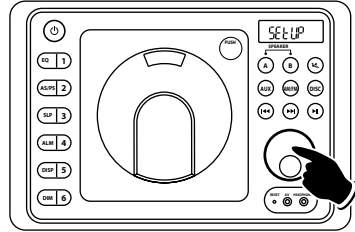

Installation

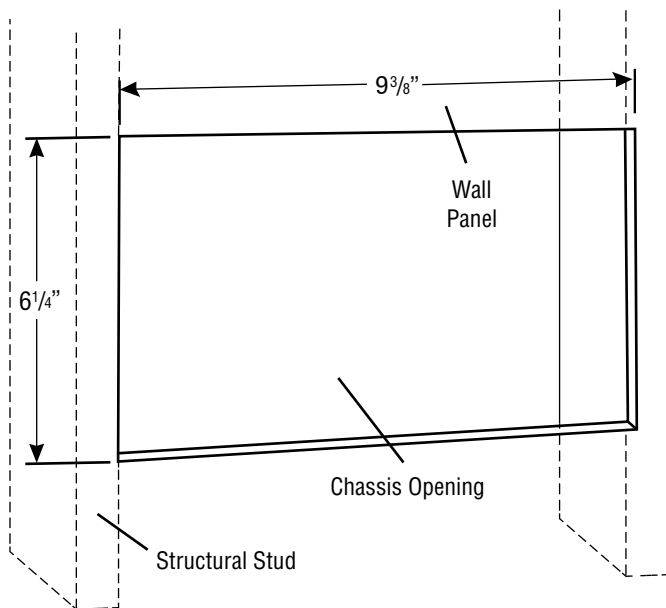

 Caution: Do not install radio without rear cover installed: No user-serviceable parts inside. Rear cover provides protection against potential fire hazard.

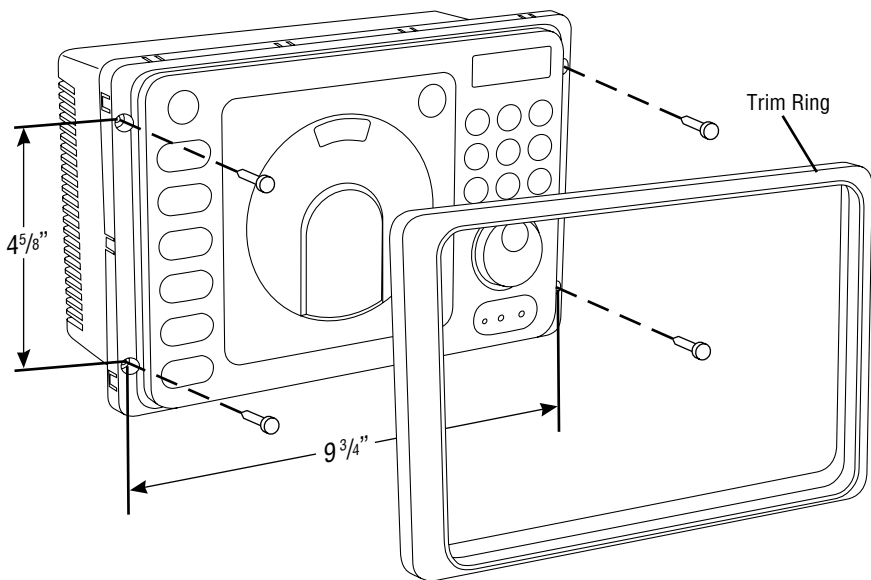

Speaker Connections

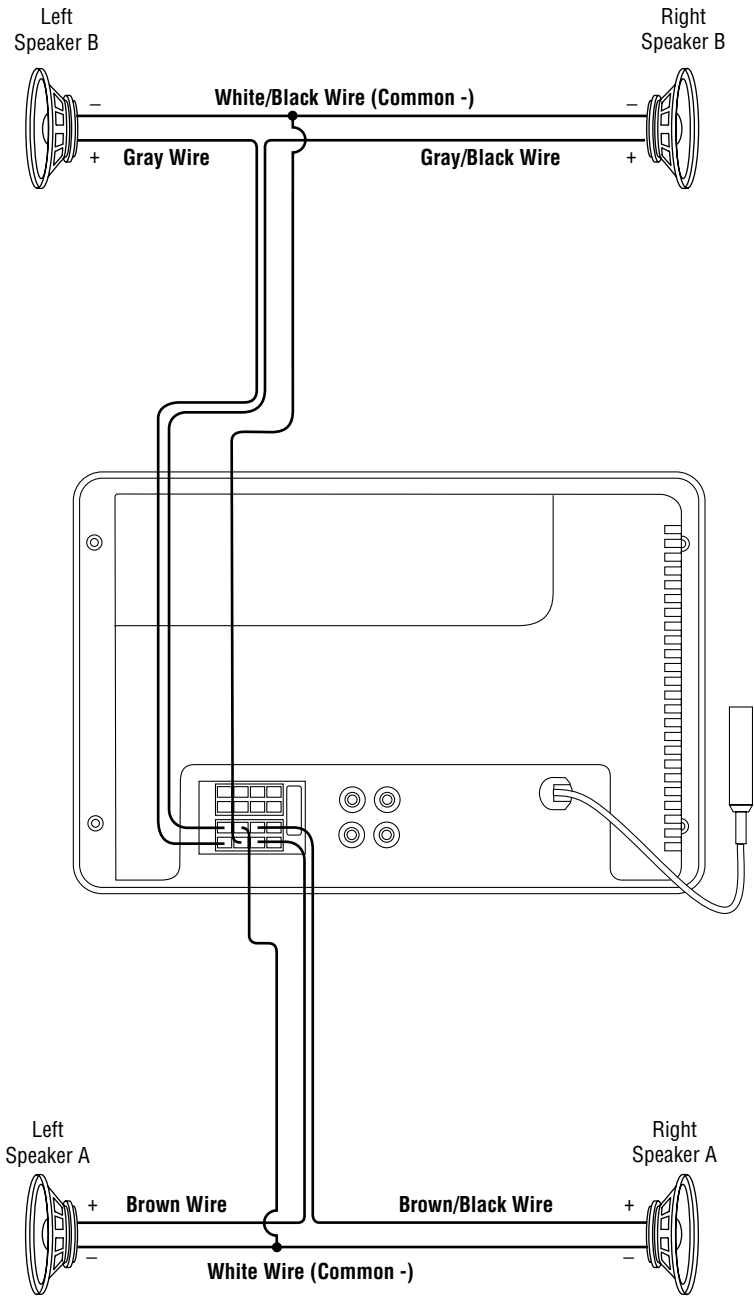

Wiring and Auxiliary Connections

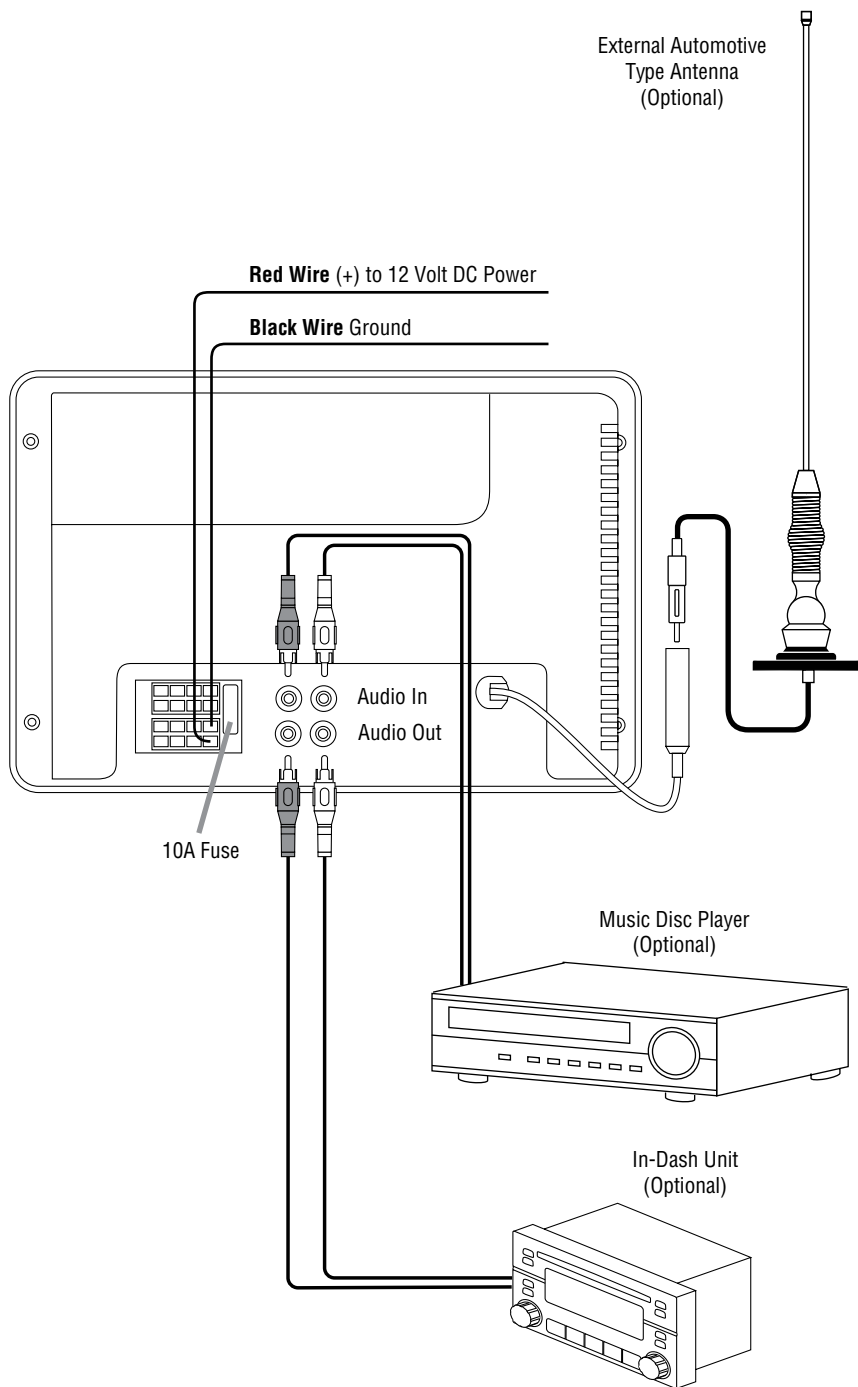

Safety Instructions

- **Read Instructions:** All the safety and operating instructions should be read before the appliance is operated.
- **Retain Instructions:** The safety and operating instructions should be retained for future reference.
- **Heed Warnings:** All warnings on the appliance and in the operating instructions should be adhered to.
- **Follow Instructions:** All operating and use instructions should be followed.
- **Water and Moisture:** The appliance should not be used near water. For example, near a bathtub, wash-bowl, kitchen sink, laundry tub, in a wet basement, or near a swimming pool, etc.
- **Wall or Cabinet Mounting:** The appliance should be mounted to a wall or cabinet only recommended by the manufacturer.
- **Heat:** The appliance should be situated away from heat sources such as radiators, heat registers, stoves, or other appliances (including amplifiers) that produce heat.
- **Power Supply:** The appliance should be connected to a power supply only of the type described in the operating instructions or as marked on the appliance.
- **Power Lines:** An outdoor antenna should be located away from power lines.
- **Object and Liquid Entry:** Care should be taken so that objects do not fall, and liquids are not spilled into the enclosure through openings.

Outdoor Antenna Grounding:

If an outside antenna is connected to the receiver, be sure the antenna system is grounded, so as to provide some protection against voltage surges and built up static charges. Section 810 of the National Electrical Code, ANSI/NFPA No. 70-1983, provides information with respect to proper grounding of the mast and supporting structure, grounding of the lead-in wire to an antenna discharge unit, size of grounding conductors, location of antenna-discharge unit, connection to grounding electrodes, and requirements for the grounding electrode. See illustration below.

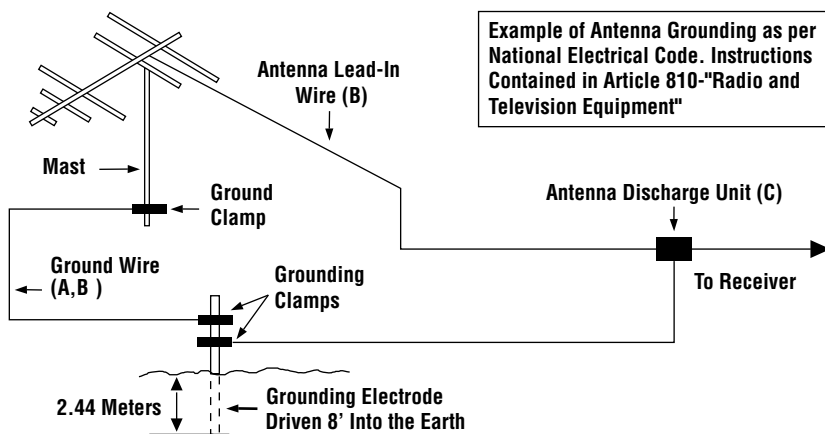

- A. Use No. 10 AWG (5.3mm²) copper, No. 8 AWG (8.4mm²) aluminum, No. 17 AWG (1.0mm²) copper clad steel or bronze wire, or larger as ground wire.
- B. Secure antenna lead-in and ground wires to house with stand-off insulators spaced from 4 feet (1.22m) to 6 feet (1.83m) apart.
- C. Mount antenna discharge unit as close as possible to where lead-in enters house.

ONE (1) YEAR LIMITED WARRANTY

Magnadyne Corporation or its authorized agents will within one year from the date of sale to you, repair, replace or refund the retail sales price of said product or any part thereof, at the option of the Magnadyne Corporation or its authorized agents, if said product or part is found defective in materials or workmanship, when properly connected and operating on the correct power requirements designated for the specific product. This warranty and Magnadyne Corporation or its authorized agent's obligations hereunder do not apply where the product was; damaged while in the possession of the consumer, subjected to unreasonable or unintended use, not reasonably maintained, utilized in commercial or industrial operations, or serviced by anyone other than Magnadyne Corporation or its authorized agents, or where the warning seal on the product is broken or the power and/or plugs are detached from the unit. Magnadyne Corporation or any of its authorized agents will not assume any labor costs for the removal and reinstallation of any product found to be defective, or the cost of transportation to Magnadyne Corporation or its authorized agents. Such cost are the sole responsibility of the purchaser.

This warranty does not cover the cabinet appearance items or accessories used in connection with this product, or any damage to recording or recording tape, or any damage to the products resulting from improper installation, alteration, accident, misuse, abuse or acts of nature.

MAGNADYNE CORPORATION OR ITS AUTHORIZED AGENTS SHALL NOT BE LIABLE TO ANYONE FOR CONSEQUENTIAL OR INCIDENTAL DAMAGES OR CLAIMS EXCEPT THOSE ACCORDED BY LAW. NO EXPRESSED WARRANTY OR IMPLIED WARRANTY IS GIVEN EXCEPT THOSE SET FORTH HEREIN. NO IMPLIED WARRANTY SHALL EXTEND BEYOND ONE YEAR FROM THE DATE OF SALE.

This warranty extends only to the original purchaser of the product and is not transferable. Some states do not allow limitations on how long an implied warranty lasts, and some states do not allow the exclusion or limitation of incidental or consequential damages, so the above limitations or exclusion may not apply to you. This warranty gives you specific legal rights, and you may have other rights that vary from state to state.

“NOTE: The manufacturer is not responsible for any radio or TV interference caused by unauthorized modifications to this equipment. Such modifications could void the User's authority to operate the equipment.”

Defective merchandise should be returned to the original point of purchase or secondly, to Magnadyne Corporation, 1111 W. Victoria Street, Compton CA 90220.

Return Authorization must be obtained before sending, or merchandise may be refused.

Free Manuals Download Website

<http://myh66.com>

<http://usermanuals.us>

<http://www.somanuals.com>

<http://www.4manuals.cc>

<http://www.manual-lib.com>

<http://www.404manual.com>

<http://www.luxmanual.com>

<http://aubethermostatmanual.com>

Golf course search by state

<http://golfingnear.com>

Email search by domain

<http://emailbydomain.com>

Auto manuals search

<http://auto.somanuals.com>

TV manuals search

<http://tv.somanuals.com>