

MAGNASONIC

Dual Deck DVD & 4 Head Hi-Fi VCR



Instruction Manual
Model: DVD833-2

Thank you for your purchase of this Magnasonic product. Please read this Instruction Manual carefully before using this Magnasonic product to ensure proper use. After reading this manual, please keep it in a safe place and refer to it when necessary.

**For additional information on this product or for help with set-up
please call the Customer Help Line at 1-800-287-4871**

Visit www.magnasonic.ca for more information about our great products

Safety Precautions



The lightning flash with an arrowhead symbol within an equilateral triangle is intended to alert the user to the presence of uninsulated "dangerous voltage" within the product's enclosure that may be of sufficient magnitude to constitute a risk of electric shock to persons.



The exclamation point within an equilateral triangle is intended to alert the user to the presence of important operating and maintenance (servicing) instructions in the literature accompanying the appliance.

	CAUTION RISK OF ELECTRIC SHOCK DO NOT OPEN	
AVIS		RISQUE DE CHOC ELECTRIQUE NE PAS OUVRIR
CAUTION: TO REDUCE THE RISK OF ELECTRIC SHOCK, DO NOT REMOVE COVER (OR BACK). NO USER-SERVICEABLE PARTS INSIDE. REFER SERVICING TO QUALIFIED SERVICE PERSONNEL. CAUTION: (VISIBLE) LASER RADIATION WHEN OPEN. DO NOT STARE INTO BEAM.		

WARNING: TO REDUCE THE RISK OF FIRE OR ELECTRIC, DO NOT EXPOSE THIS APPARATUS TO RAIN OR MOISTURE.

THE APPARATUS SHALL NOT BE EXPOSED TO DRIPPING OR SPLASHING AND THAT NO OBJECTS FILLED WITH LIQUIDS, SUCH AS VASES, SHALL BE PLACED ON THE APPARATUS. DO NOT OPEN THE CABINET, DANGEROUS HIGH VOLTAGES ARE PRESENT INSIDE THE ENCLOSURE. ONLY QUALIFIED SERVICE PERSONNEL SHOULD ATTEMPT THIS.

CAUTION: TO PREVENT ELECTRIC SHOCK, MATCH WIDE BLADE OF PLUG TO WIDE SLOT, AND FULLY INSERT.

CAUTION: This player employs a Laser System. To prevent direct exposure to the laser beam, do not try to open the enclosure. Visible laser radiation when open and interlocks defeated. Use of controls or adjustments or performance of procedures other than those specified herein may result in hazardous radiation exposure. DO NOT STARE INTO BEAM.

To ensure proper use of this product, please read this operating instructions carefully and retain for future reference. Should the unit require maintenance, contact an authorized service location, or contact local dealer. Only qualified service personnel should remove the cover.

IC NOTICE: Since DVD circuitry may cause interference to other radio or television tuners nearby, switch this unit off when not in use or move it away from the affected tuner.

NOTE: This digital apparatus does not exceed the Class B limits for radio noise emissions from digital apparatus as set out in the Radio Interference Regulations of Industry Canada. These limits are designed to provide reasonable protection against harmful interference in a residential installation. This equipment generates, uses and can radiate radio frequency energy and, if not installed and used in accordance with the instruction, may cause harmful interference to radio communications. However, there is no guarantee that interference will not occur in a particular installation. If this equipment does cause harmful interference to radio or television operation (which can be determined by turning the equipment off), the user is encouraged to try to correct the interference by one or more of the following measures:

- Reorient or relocate the receiving antenna.
- Increase the separation between the equipment and receiver.
- Connect the equipment into an outlet on a circuit different from that to which the receiver is connected.

Consult the dealer or an experienced radio / TV technician for help.

This Class B digital apparatus complies with Canadian ICES-003.

WARNING: Changes or modifications made to this equipment, not expressly approved by manufacturer or parties authorized by manufacturer will void all the manufacture warranties.

THE REGION CODE FOR THE UNIT IS 1.



Since it is very usual for DVD movies to be released at different times in different regions of the world, all players have region codes and discs can have an optional region code. If you load a disc of a different region code to your player, you will see the region code notice on the screen. The disc will not play, and should be unloaded.

For Customer Use:

In spaces provided below, record the Model and Serial No. located on the rear panel of your player.

Model No. _____ Serial No. _____

Retain this information for future reference.

Important Safety Instructions

CAUTION: Use of controls or adjustments or performance of procedures other than those specified herein may result in hazardous radiation exposure.

CAUTION: PLEASE READ AND OBSERVE ALL WARNINGS AND INSTRUCTIONS GIVEN IN THIS OPERATING INSTRUCTION AND THOSE MARKED ON THE UNIT. RETAIN THIS BOOKLET FOR FUTURE REFERENCE.

This set has been designed and manufactured to assure personal safety. Improper use can result in electric shock or fire hazard. The safeguards incorporated in this unit will protect you if you observe the following procedures for installation, use and servicing. This unit fully transistorized and does not contain any parts that can be repaired by the user.

DO NOT REMOVE THE CABINET COVER, OR YOU MAY BE EXPOSED TO DANGEROUS VOLTAGE. REFER SERVICING TO QUALIFIED SERVICE PERSONNEL ONLY.

1. Read these instructions.
2. Keep these instructions.
3. Heed all warnings
4. Follow all instructions.
5. Do not use this apparatus near water.
6. Clean only with dry cloth
7. Do not block any ventilation openings. Install in accordance with the manufacturer's instructions.
8. Do not install near any heat sources such as radiators, heat registers, stoves, or other apparatus (including amplifiers) that produce heat.
9. Do not defeat the safety purpose of the polarized or grounding-type plug. A polarized plug has two blades with one wider than the other. A grounding type plug has two blades and a third grounding prong. The wide blade or the third prong is provided for your safety. If the provided plug does not fit into your outlet, consult an electrician for replacement of the obsolete outlet.
10. Protect the power cord from being walked on or pinched particularly at plugs, convenience receptacles, and the point where they exit from the apparatus.
11. Only use attachments/accessories specified by the manufacturer.



12. Use only with the cart, stand, tripod, bracket, or table specified by the manufacturer, or sold with the apparatus. When a cart is used, use caution when moving the cart/apparatus combination to avoid injury from tip-over.

13. Unplug this apparatus during lightning storms or when unused for long periods of time.

14. Refer all servicing to qualified service personnel. Servicing is required when the apparatus has been damaged in any way, such as power-supply cord or plug is damaged, liquid has been spilled or objects have fallen into the apparatus, the apparatus has been exposed to rain or moisture, does not operate normally, or has been dropped.

ADDITIONAL SAFETY INSTRUCTIONS

15. When you use headphones, keep the volume at a moderate level. If you use the headphones continuously with high volume sound, it may cause tearing damage.

16. Do not overload wall outlets; extension cords, or integral convenience receptacles as this can result in a risk of fire or electric shock.

17. Keep your fingers well clear of the disc tray as it is closing. Neglecting to do so may cause serious personal injury.

18. Do not place a heavy object on or step on the apparatus. The object may fall, causing serious personal injury and serious damage to the apparatus.

19. Do not use a cracked, deformed, or repaired disc. These discs are easily broken and may cause serious personal injury and apparatus malfunction.

20. Caution - Do not attempt to service this product yourself as opening or removing covers may expose you to dangerous voltage or other hazards. Refer all servicing to qualified service personnel.

Caution: This unit should only be serviced by an authorized and properly trained technician. Opening the cover or other attempts by the user to service this unit may result in serious injury or death from electrical shock, and may increase the risk of fire.

Precautions

Notes on handling

- When shipping the Player, the original shipping carton and packing materials come in handy. For maximum protection, repack the unit as it was originally packed at the factory.
- Do not use volatile liquids, such as insect spray, near the player. Do not leave rubber or plastic products in contact with the Player for a long time. They will leave marks on the finish.
- The top and rear panels of the Player may become warm after a long period of use. This is not a malfunction.
- When the Player is not in use, be sure to remove the disc and turn off the power.
- If you do not use the Player for a long period, the unit may not function properly in the future. Turn on and use the player occasionally.

Notes on locating

- Place the player on a level surface. Do not use is on a shaky or unstable surface such as a wobbling table or inclined stand. The loaded disc may come off the proper position and cause damage to the player.
- When you place this player near a TV or radio, the playback picture may become poor and the sound may be distorted. In this case, place the player away from the TV or radio.

Notes on cleaning

Use a soft, dry cloth for cleaning.

- For stubborn dirt, soak the cloth in a weak detergent solution, wring well and wipe. Use a dry cloth to wipe it dry. Do not use any type of solvent, such as thinner and gasoline, as they may damage the surface of the player.
- If you use a chemical saturated cloth to clean the unit, follow that product's instructions.

To obtain a clear picture

The player is a high tech, precision device. If the optical pick-up lens and disc drive parts are dirty or worn down, the picture quality becomes poor. To obtain a clear picture, we recommend regular inspection and maintenance (cleaning or parts replacement) every 1,000 hours of use depending on the operating environment. For details, contact your nearest dealer.

Notes on moisture condensation

Moisture condensation damages the player. Please read the following carefully.

Moisture condensation occurs, for example, when you pour a cold drink into a glass on a warm day. Drops of water form on the outside of the glass. In the same way, moisture may condense on the optical pick-up lens inside this unit, one of the most crucial internal parts of the player.

Moisture condensation occurs during the following cases.

- When you bring the player directly from a cold place to a warm place.
- When you use the player in a room where you just turned on the heater, or a place where the cold wind from the air conditioner directly hits the unit.
- In summer, when you use the player in a hot and humid place just after you move the unit from an air-conditioned room.
- When you use the player in a humid place.

Do not use the player when moisture condensation may occur.

If you use the player in such a situation, it may damage discs and internal parts. Remove the disc, connect the power cord of the player to the wall outlet, turn on the player, and leave it for two or three hours, the player will have warmed up and evaporated any moisture. Keep the player connected to the wall outlet and moisture condensation will seldom occur.

UNPACKING

First check and identify the contents of your Combo Player package, as listed below:

VCR&DVD Player	1
AUDIO cable(red and white)	1
Video cable(yellow)	1
Batteries(AAA)	2
Remote control	1
RF(Radio Frenquency)Antenna Cable	1
User's manual	1

If any item should be damaged or missing, please inform your dealer without delay.

Keep the packaging materials, you may need them to transport your player in the future.

WHERE TO PLACE YOUR COMBO PLAYER

A. Place the unit on a firm, flat surface.

B. When you place this combo player near a radio, or VCR, the playback picture may become poor and/or distorted. In this situation, move the Combo player away from the other units.

C. If placed in a cabinet, please allow at least 2.5 cm (1 inch) of free space all around the player for proper ventilation.

TO OBTAIN A CLEAR PICTURE

The Combo Player is a precision device. If the optical pick-up lens, disc drive parts and head are dirty or worn down, picture quality can become poor. We recommend regular inspection and maintenance every 1,000 hours of use depending on the operating environment..

Note:

The OSD and illustration in this manual may be somewhat different from the actual situation. Please take the unit as the standard.

Introduction

Your new VCR&DVD PLAYER is designed for you to enjoy all forms of disc media and VHS Tape. Your player will allow you to enjoy full-length motion pictures with "at-the-movies" picture and cinema quality sound.

Your new player also supports CD, MP3, and WMA. Your player also has several unique features, including AFF (Active Full Screen Function that allows you to view wide screen movie presentations in full screen mode), S-Video and component video output (for greater picture clarity), Parental Control (to prevent children from viewing inappropriate content) and **JPEG** CD compatibility (so you can view photos on your TV).

Notes on Discs

HOW TO HANDLE, CLEAN, AND STORE DISCS.

HANDLING DISCS

- Do not touch the playback side of the disc.
- Do not attach paper or tape to discs.

NOTE: The manufacturer shall not be responsible for damage that may occur to a disc from being operated in the player.





CLEANING DISCS

- Fingerprints and dirt on the disc cause picture and sound deterioration. Wipe the disc from the center outward with a soft cloth. Always keep the disc clean.
- If you cannot wipe off the dirt off, wipe the disc lightly with a slightly moistened soft cloth and finish with a dry cloth.
- Do not use any type of solvent such as a thinner, benzene, commercially available cleaners or anti-static spray for vinyl LP's.



PLAYABLE DISCS

This Combo Player can playback the following discs.

	Disc Mark	Contains	Disc Size	Maximum playback time
DVD video disc		Audio + Video (moving pictures)	12 cm	Approx. 4 hours (single sided disc)
				Approx. 8 hours (double sided disc)
Audio CD		Audio	12 cm	Approx. 74 minutes
			8 cm (CD single)	Approx. 20 minutes

STORING DISCS

- Do not store discs in places subject to direct sunlight or near heat sources.
- Do not store discs in places subject to moisture and dust.
- Store discs vertically in a case. Stacking or placing objects on discs outside of their case may cause warping.

TYPE OF TV SYSTEM

Connect this Combo Player to a TV with the NTSC system.

Table of Contents

Safety Precautions.....	1	Locating a Specific Title, Chapter or Track.....	16
Important Safety Instructions.....	2	Using the On-screen Display.....	17
Introduction.....	4	Playing Repeatedly.....	18
Notes On Discs.....	4	Playing in Random Order.....	18
Identification of Controls.....	5	Zooming a Picture On DVD.....	18
Remote Control.....	6	Selecting The Camera Angle/ Language/Audio Settings.....	19
Connecting with TV.....	8	Selecting Subtitles	19
Connecting Optional Equipment.....	8	Playing in a Favorite order.....	20
Connecting TV With S-VIDEO /Component Jack, AMP With Digital Audio Out Jack.....	9	MP3 Operation.....	20
Progressive Scan.....	9	WMA Operation.....	21
VCR Playback.....	10	Playing Your JPEG Files.....	22
Recording.....	10	Memo On Output Sounds.....	22
Search Function.....	11	Setting the Parental Lock.....	23
VCR Setting.....	12	Customizing the Function Settings.....	24
AFF Function.....	14	Troubleshooting Guide.....	25
Playing Back a Disc.....	14	Specifications.....	26

Identification of Controls

FRONT PANEL

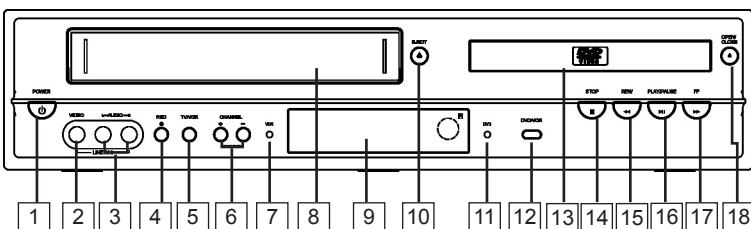

- 1 POWER
- 2 VIDEO INPUT JACK
- 3 AUDIO INPUT JACK
- 4 RECORD
- 5 TV/VCR
- 6 CHANNEL UP/DOWN BUTTON
- 7 VCR INDICATOR
- 8 VCR DECK
- 9 LED DISPLAY
- 10 EJECT
- 11 DVD INDICATOR
- 12 DVD/VCR
- 13 DISC TRAY
- 14 STOP
- 15 FAST REVERSE
- 16 PLAY/PAUSE
- 17 FAST FORWARD
- 18 OPEN/CLOSE

REAR PANEL

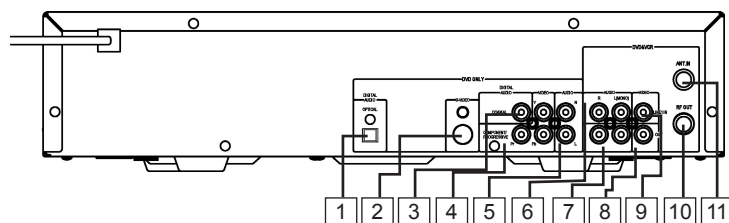

- 1 DIGITAL AUDIO-OPTICAL OUTPUT
- 2 S-VIDEO OUTPUT
- 3 DIGITAL AUDIO-COAXIAL OUTPUT
- 4 COMPONENT/PROGRESSIVE VIDEO
OUTPUT Y Pb Pr
- 5 ANALOG AUDIO OUTPUT L R
- 6 ANALOG AUDIO INPUT L R
- 7 ANALOG AUDIO OUTPUT L R
- 8 COMPOSITE VIDEO OUTPUT
- 9 COMPOSITE VIDEO INPUT
- 10 RF OUTPUT
- 11 ANTENNA INPUT

Remote Control

THE INSTRUCTIONS BELOW DESCRIBE THE FUNCTIONS ON THE REMOTE CONTROL.

- | | |
|-----------------------|--------------------------------------|
| 1. POWER | 18. NUMBER BUTTONS |
| 2. STEP | 19. OPEN/CLOSE |
| 3. SUBTITLE | 20. ANGLE |
| 4. SHUFFLE | 21. I/P (INTERLACE/PROGRESSIVE SCAN) |
| 5. REPEAT | 22. ZOOM |
| 6. AUDIO | 23. AFF |
| 7. A-B REPEAT | 24. DISPLAY |
| 8. DVD | 25. REC |
| 9. VCR | 26. TITLE |
| 10. SETUP | 27. ENTER |
| 11. MENU | 28. STOP |
| 12. DIRECTION BUTTONS | 29. SKIP REVERSE |
| 13. PLAY/PAUSE | 30. SKIP FORWARD |
| 14. FAST FORWARD | 31. SPEED |
| 15. FAST REVERSE | 32. TV/VCR |
| 16. PROGRAM | 33. COUNTER/CLOCK |
| 17. SEARCH | 34. INPUT SEL. |
| | 35. CLEAR/RESET |

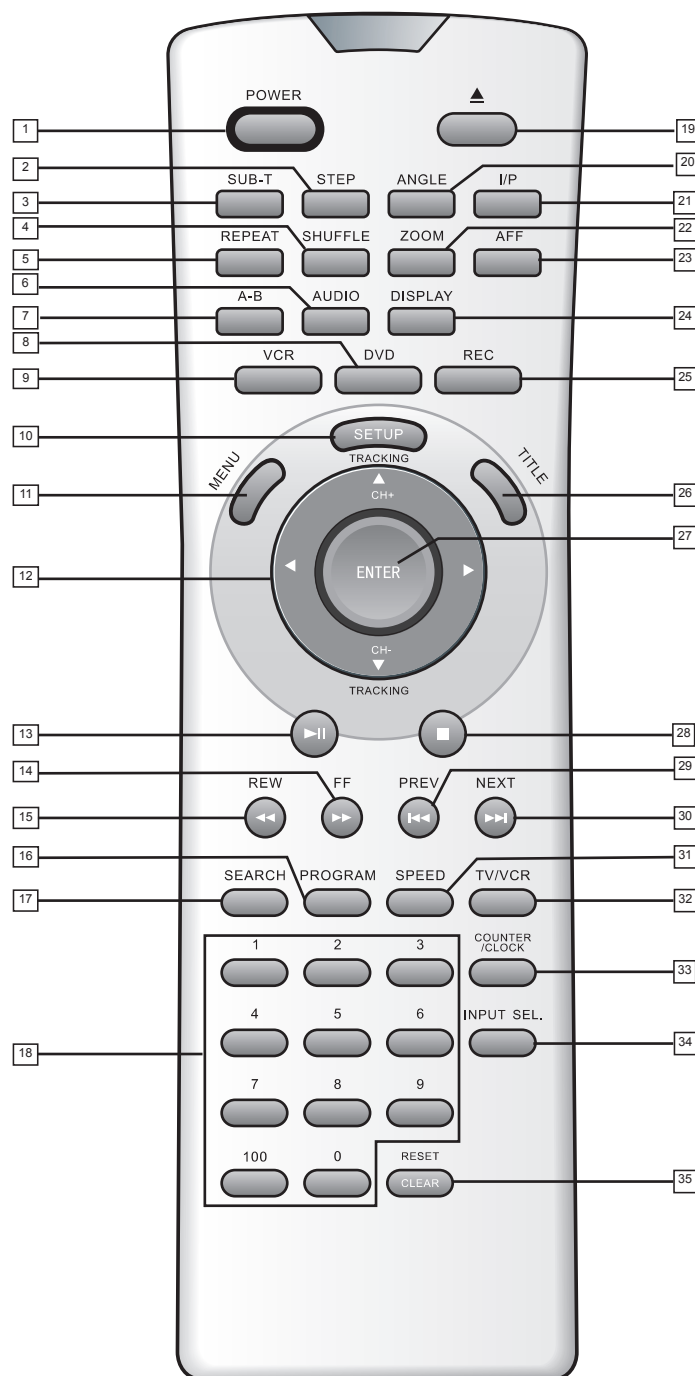

- POWER button on the remote control is for standby power.
- When "⊘" displayed on TV, function is not operational on the disc.
- Child Lock!!!

Press the POWER button of the remote control for about 8 seconds. No buttons of front panel and remote control can be operated now and Lock indicator "⊘" will be displayed on window display. To release child lock, press the POWER button of the remote control for about 8 seconds.

Remote Control

PREPARING THE REMOTE CONTROL

To operate the Combo Player, you must first place the batteries in the remote control.

1



Open the cover.

2

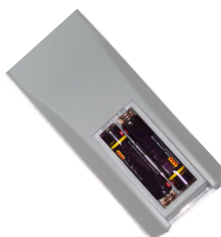

Insert batteries ('2 x AAA size, included).

Make sure to match the + and - on the batteries to the marks inside the battery compartment.

3

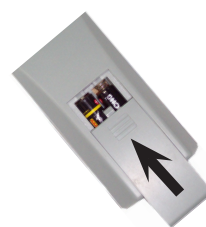

Close the cover.

OPERATING WITH THE REMOTE CONTROL

Operating player with the remote control.

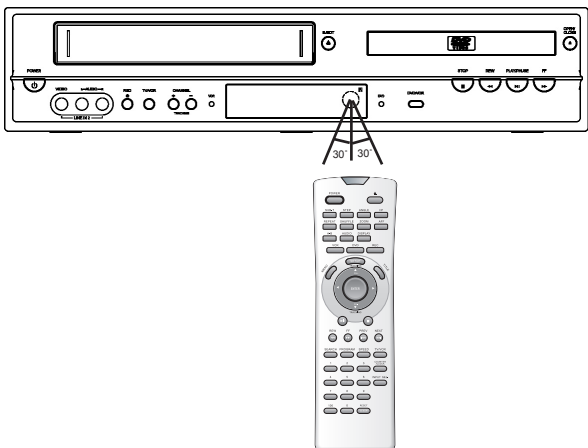

The remote control must point at the remote sensor in order for the remote to function correctly.

Distance: Maximum of 7 m from the front of the remote sensor.

Angle: Approximately 30° from each direction.

*Do not place the remote control under intense light source such as direct sunlight.

! BATTERIES

INCORRECT USE OF BATTERIES MIGHT CAUSE THEM TO LEAK, CORRODE OR EXPLODE.

- Do not place the batteries in the wrong direction.
- It is dangerous to charge, heat, open, or short-circuit the batteries.
- Do not leave dead batteries or mix new with old batteries in the remote control.
- When not using the remote control for a long duration of time, remove the batteries. When operating range becomes reduced, replace batteries.
- If battery leakage occurs, wipe the battery liquid from the battery compartment, then replace batteries.

! REMOTE CONTROL

- The remote control should be aimed directly towards the remote sensor of the Combo Player.

Connecting With TV

- In connecting RF cable to TV, set TV channel to CH3.

How to Connect with RF cable or AV cable

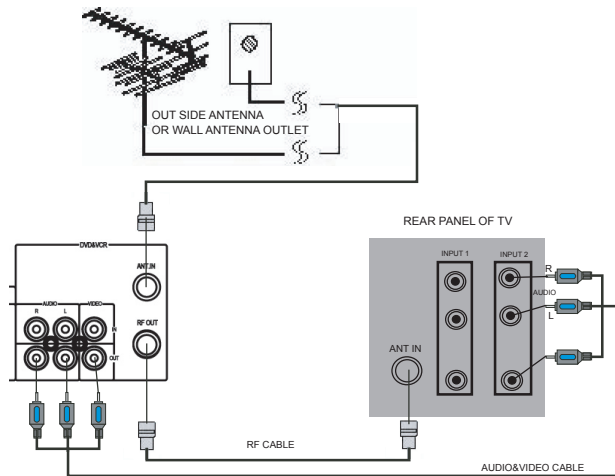

- 1 Connect antenna cable to the "ANT.IN" jack on rear panel of player.
- 2 Connect TV to the Combo Player by connecting the "RF OUT" jack with "ANT.IN" jack of the TV with RF cable(included).
- 3 Connect AV OUT jack on VCR&DVD PLAYER to AV IN jack of the TV with RCA(composite) cables(included).

- Connect with Audio/Video terminal, you can enjoy more clear video and audio.

Connecting With Optional Equipment

How to Connect

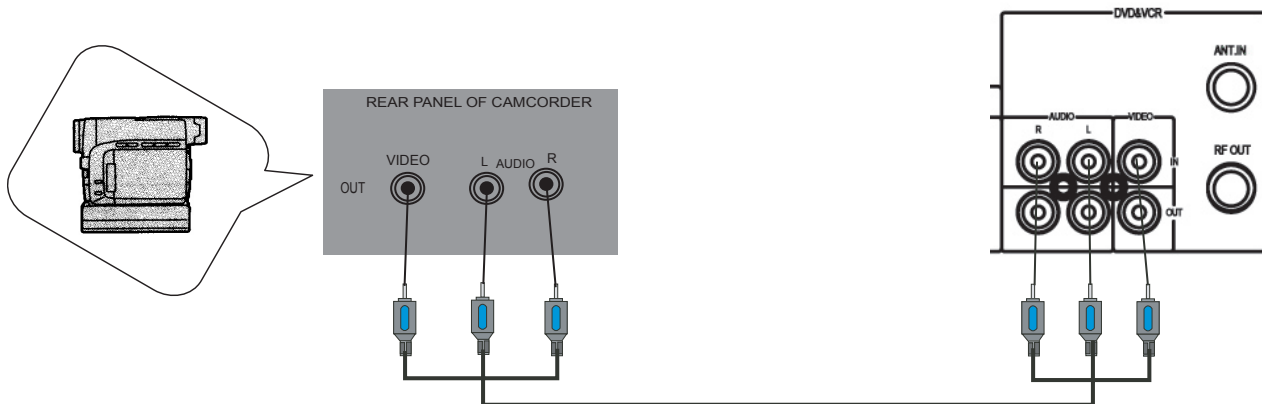

- Connect AV OUT jack on camcorder (or playback video) to AV IN jack on rear panel (or front panel) of VCR&DVD PLAYER with RCA(composite) cables.

Connecting TV With S-VIDEO/Component Jack, AMP With Digital Audio Out jack

How to Connect(DVD only)

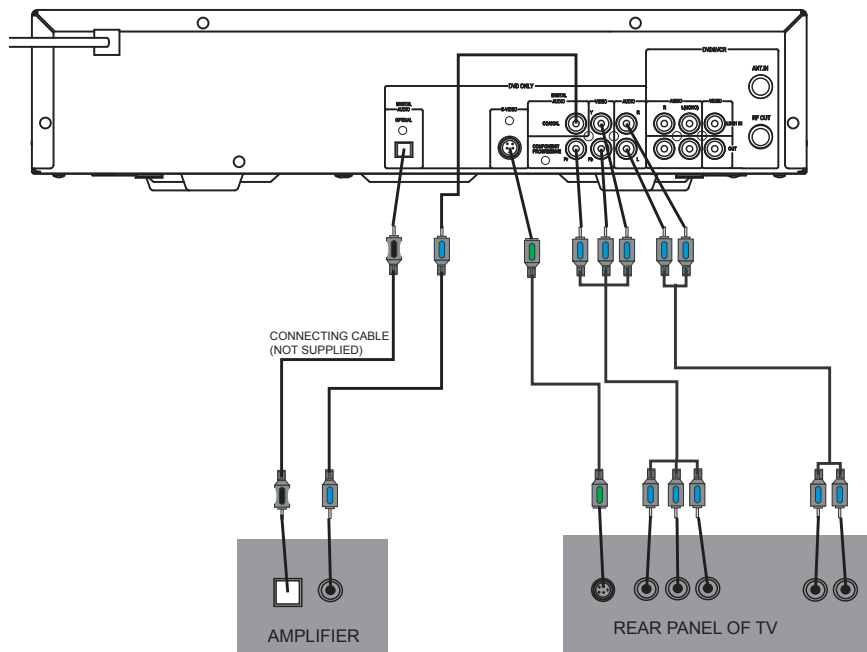

- 1 Connect S-VIDEO OUT or COMPONENT OUT to TV.
- 2 Connect analog AUDIO OUTPUT(L/R) jack to TV.
- 3 Connect COAXIAL or OPTICAL to AMP of Dolby Digital.

Progressive Scan

WHAT IS PROGRESSIVE SCAN?

With the introduction of Digital/High-Definition TV, televisions can scan viewable information at double the frequency of standard NTSC televisions. This provides for greater picture clarity and detail. This player provides the delivery of images to these newer televisions with greater detail and film like quality. Connect the player to your HDTV ready television using the component video inputs/outputs (component video cables not supplied, available at your local electronics store). Do not substitute RCA cables for component cables, eventough they look alike, as this might damage the player.

HOW TO SETUP THE VIDEO SCAN MODE?

Connect this Player with Y, Pr and Pb, if your TV has Progressive Scan and Component Video input. Press I/P button on remote control unit to switch between Interlace & Progressive Scan mode.

It is forbidden by law to copy, broadcast, show, play in public, and rent copyrighted material without permission.

DVD video discs are copy protected, and any recordings made from these discs will be distorted.

Manufactured under license from Dolby Labs.

"Dolby" and the double-D symbol are trademarks of Dolby Laboratories. Confidential unpublished works.

© 1992-1997 Dolby Laboratories, Inc. All rights reserved.

VCR Playback

- 1 Press POWER button to power on.
Press VCR button to change into VCR mode.
- 2 Insert the desired tape.

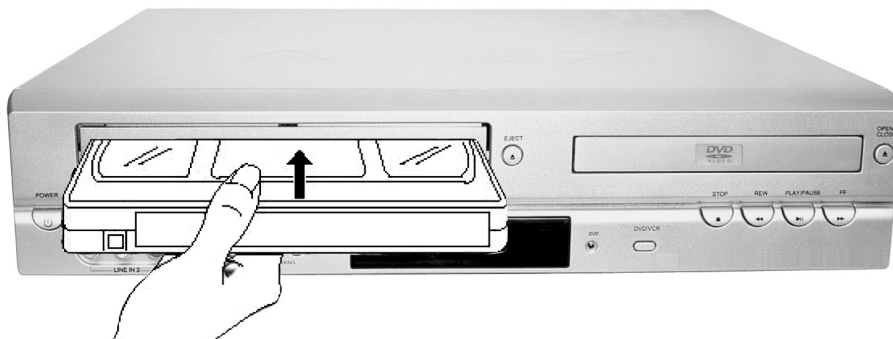

- 3 If you want to start playback, press ►|| button. When the playback picture is partially noisy, adjust with TRACKING +/- button.
- 4 To stop it, press ■ button.
 - For pause, press ►|| button in playback mode.

- 5 To playback forward fast or to reverse it, press ►► or ◀◀ button, respectively.
 - Press EJECT button on the front panel or ▲ button on remote control to remove the tape.

Recording

To Record With VCR

- 1 Press POWER button to power on.
 - Press VCR button to change into VCR mode.
 - Power on TV and select Ch3, or select AV input.
- 2 Insert a tape for recording.
 - Insert a tape with recording tab.
- 3 With CH+/- and NUMBER button, select the desired broadcasting channel or external input unit to record.

- 4 Select the desired speed (SP or SLP) with SPEED button.
- 5 Press REC button.
- 6 press ►|| button to pause recording, press again to resume.
 - If the pause status continues for five minutes, the recording will be cancelled automatically.
- 7 To stop recording, press ■ button.

To Enjoy DVD during recording

- If you want to playback DVD during recording with video, insert a DVD disc.
- Place the desired DVD disc on DVD tray, press DVD button

to switch into DVD mode and press ►|| button. Then, you can watch DVD.

To Copy From DVD To Videotape

- Press DVD button to convert output into DVD mode.
- 1 Insert the desired DVD disc.
 - you can't copy a DVD disc with copy protect function.
 - 2 Insert a tape for recording.

- 3 Press REC button.
- 4 To stop copy, press VCR button and then press ■ button.
 - If not, DVD plays again and video continues to copy.

This product incorporates copyright protection technology that is protected by method claims of certain U.S patents and other intellectual property rights owned by Macrovision Corporation and other right owners Use of this copyright protection technology must be authorized by Macrovision Corporation, and is intended for home and other limited viewing uses only unless otherwise authorized by Macrovision Corporation. Reverse engineering or disassembly is prohibited.

Recording

One Touch timer Recording(OTR)

One-Touch Recording(OTR) allows you to record in 30-minute increments up to 4 hours at the touch of a button.

1 Start Recording

Follow the instructions on "Recording".

2 Activate OTR

While in Record mode, press the REC button again to activate One-Touch Recording(OTR).

3 Add Recording Time

Continue pressing REC to add recording time in 30 minute increments up to 4 hours.

- The VCR&DVD PLAYER stops recording automatically when the time has elapsed.

4 Press ■ button to stop recording mode.

Search Function

Search Counter Zero

- Press VCR button to change into VCR mode.

1 Press the SETUP button on the remote control.

2 Press the ▼ button to select the "Search", and press ENTER button.

3 Press ENTER button at "Go To Zero Search" to start.

- AS soon as the counter searches 0:00:00 , the tape will play automatically.

Search Counter

- Press VCR button to change into VCR mode.

1 Press the SETUP button on the remote control.

2 Press the ▼ button to select the "Search", and press ENTER button.

3 Press the ▼ button to select the "Counter Search", and press ENTER button.

4 Enter the desired time by pressing the numerical keys and

press ENTER button when you are finished entering the correct time.

- The counter appears on screen and the LED display.

- To make changes to the time you have entered previously, press the ◀ / ▶ buttons to go to the input field (hours, minutes etc.) you want to change and use numerical buttons to update the input fields.

Search Index Forward/backward

- The index signal is recorded on the tape automatically when the recording is started. You can view a recording at a specific start point by using this search feature.

- Press VCR button to change into VCR mode.

1 Press the SETUP button on the remote control.

2 Press the ▼ button to select the "Search", and press

ENTER button.

3 If your search is forward direction, highlight "Index Search(+)" Index searching motion, then press ENTER button.

4 If your search is backward direction, highlight "Index Search(-)" Index searching motion, then press ENTER button.

Search Index Number

- Use this feature to search for a specific index number.

- Press VCR button to change into VCR mode

1 Press the SETUP button on the remote control.

2 Press the ▼ button to select the "Search", and press ENTER button.

3 Press the ▼ button to select the "Index Number Search", and press ENTER button.

- If your search is forward direction, press up ▲ button to select desired Index Number.

- If your search is reverse direction, press down ▼ button to select desired Index Number.

4 After the correct index number is highlighted on the screen, press the ENTER button to move to the specific index number you have requested.

Clock

• Press VCR button to change into VCR Mode and follow the procedures below.

- 1 Press the SETUP button on the remote control.
- 2 Press the ENTER button, while highlighting CLOCK SET.
- 3 Set the current date and time with ▲▼◀▶ button and

NUMBER buttons.

For DATE SET, follow the order of Month/Day/ Year ; for TIME SET, follow the order of Hour/Minute in CLOCK SET screen.

- 4 Press SETUP button to confirm your selection.
5. Press SETUP button again to get out of the menu system.

Programming a Recording

- 1 In VCR mode press the SETUP button on the remote control.
- 2 Press the ▼ button to select the "Program Set" and press ENTER button.

3 Select "Channel"

cable → video 1 → video 2 → Antenna



• If you choose Cable or Antenna as the input signal, press the ► button once to be able to set the channel number using the numerical buttons.

4 Select "Start Date"

• Move into "Start Date" with ► button and then, select the desired number to record with up/down button or number button

5 Select "REC cycle".

• Move into "REC Cycle" with ► button and then, select the desired one with up/down button

• REC cycle changes in the following order:

One Time → weekly → weekdays → Daily



6 Select Start Time

• Move into "Start Time" with ► button and then, select the desired number to record with up/down button or number

button.

7 Select End time

• Move into "End Time" with ► button and then, select the desired number to record with Up/down button or number button.

8 Select Tape Speed

• Move into "Tape Speed" with ► button and then, select the desired one with up/down button

• Recording speed changes in the following order:

SP → SLP



• Press SETUP button to confirm the program. Note that the player offers you the ability to set-up a maximum of 8 programs in total. Once you have confirmed the program. The screen will move to the next program entry form as the title at the top of the screen has changed to show " PROGRAM 2 " or higher. If you want to exit the programming screen, simply press the SETUP button.

• Press NEXT and PREV button to scroll through the 8 event-programming screens.

• Press the POWER button to activate timer recording.

Channel Set-up

• This function can only be accessed in STOP mode (when there is no tape playing).

• Press VCR button to change into VCR mode and follow the procedure below.

1 Press the SETUP button on the remote control.

2 Press the ▼ button to highlight and select (Enter) the " Channel Set".

3 Selecting cable or antenna viewing

• You must set the viewing mode for your VCR, choosing either CABLE (cable system connection) or ANTENNA(antenna connection). To set the viewing mode:

• Press ENTER to toggle between CABLE and ANTENNA.

4. SELECT "Manual Set"

This function allows you to manually add / delete channels from the TV's memory (in case you don't like a certain channel

or if you are missing a certain channel).

Press the ▼ button until "Manual Set" is highlighted. Use the ◀ / ▶ or numerical buttons to select the channel you want to add / erase. Now press the ENTER button to toggle between "Add" and "Erase". If you select "Add". the channel will be memorized. If you select "Erase", the channel will be removed from memory. Press the ◀ / ▶ buttons now to select another channel you want to modify. Once you are done making channel modifications, either press ▼ / ▲ buttons to move to another setting, or press SETUP button to return to previous menu.

5 SELECT "Auto Preset"

• Press ▼ button in Channel Set to highlight "Auto Preset"

• Press ENTER button to detect all the available channels automatically and memorize them.

On-Screen Menu Language

1 Press the SETUP button on the remote control. The initial MENU is displayed.

2 Press the ▼ button to select the "Language Select" and

press ENTER button

3 Select the language among English, Spanish and French.

VCR Setting

Setting The OSD Display

- This function allows you to view tape information on the TV screen when you start or stop tape playback.
 - Press VCR button to change into VCR mode
- 1 Press the SETUP button on the remote control.
 - 2 Press the ▼ button to highlight and select the "Option", and

press ENTER button.

- 3 Press ENTER button until the appropriate system is selected. ("On" or "Off")
- 4 Press SETUP button to quit.

Auto Power Off

- Once a tape has been played until the end, the tape will be rewound completely and the player will go into standby mode.
 - Press VCR button to change into VCR mode
- 1 Press the SETUP button on the remote control.
 - 2 Press the ▼ button to select the "Option", and press ENTER

button.

- 3 Press the ▼ button to select the "Auto Power Off".
- 4 Press ENTER button, until the appropriate system is selected. ("Yes" or "No")
- 5 Press SETUP button to quit.

RF Out

- This function allows you to change the output channel to channel 3 or 4.
 - Press VCR button to change into VCR mode
- 1 Press the SETUP button on the remote control.
 - 2 Press the ▼ button to select the "Option", and press

ENTER button.

- 3 Press the ▼ button to select the "Output Channel".
- 4 Press ENTER button, until the appropriate system is selected. ("CH3" or "CH4")
- 5 Press SETUP button to quit.

Tape Handling

- 1 Do not use any tapes with the following characteristics. Damage of video head or cut/coiling of tape may cause failure.

- Tape with mold
- Tape stained with juice or attachments
- Tape having lose film inside
- Disassembled tape

- 2 Moisture condensation may occur in tape. Moisture condensation can cause damage to the tape and the player. Therefore, if this occurs, wait for the moisture to disappear before using it in the player.

- 3 After use, store tape vertically in a case to prevent loose.

- 4 Do not store in the following places.

- High temperature and humidity
- Subject to mold formation
- Subject to direct sunlight
- Subject to dirt or dust
- Near strong magnetic materials such as speaker

AFF Function

WHAT IS AFF?

AFF stands for Active Full-screen Function. It allows you to fill the television screen viewing area when using a wide screen formatted DVD. Press the AFF button on your remote control, this will eliminate black bars on the top & bottom of the TV screen when viewing movies with an aspect ratio of 1.85:1 and minimize (but not eliminate) black bars on movies with a wider aspect ratio (2.35:1).

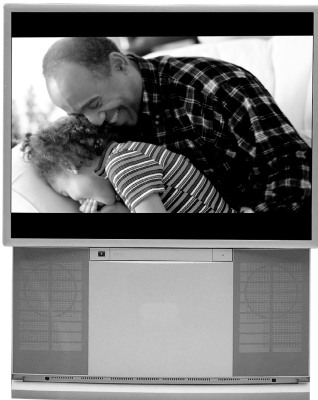

Before AFF

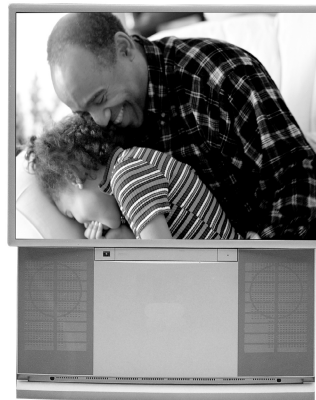

After AFF

Playing Back a Disc

HOW TO PLAYBACK A DISC.

Basic Playback

How to playback DVD video discs.

- Turn on the TV and select the video input source which is connected to the Combo Player.

1. Press the POWER button on the front panel. Press DVD button of remote control to change into DVD mode.
2. Press the OPEN/CLOSE button.

This will open the disc tray.

3. Place the disc on the disc tray.

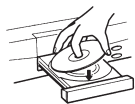

Be sure the playback side is faced down.

4. Press the ►|| button.

After closing the disc tray, playback will start.



- A disc may be damaged if not correctly placed on the guides in the disc tray. This may also cause the Combo Player to malfunction.



- The menu screen will appear automatically or you may access the menu screen by pressing the TITLE button.



- Moving the Combo Player during playback may cause damage to the disc as well as the player.
- To open and close the disc tray, you should only use the OPEN/CLOSE button on the remote control or Combo Player.

Playing Back a Disc

ABOUT DVD, CD

DVD, CD icons will appear depending on the disc being played back.

DVD: DVD video discs

CD: Audio CDs

HOW TO START PLAYBACK FROM THE MENU SCREEN

1. Press ▲/▼/◀/▶ or the number buttons to select the title.

2. Press the ENTER button.

The Combo Player will start playback from the title selected.

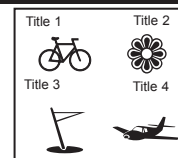

HOW TO PAUSE PLAYBACK (STILL PLAYBACK)

Press the ►|| during playback.

Press the ►|| button to resume normal playback.

HOW TO REMOVE THE DISC

Press the OPEN/CLOSE button.

Wait until the disc tray is completely open before removing any discs.

After removing the discs, press the OPEN/CLOSE button to close the disc tray.

HOW TO STOP PLAYBACK

Press the STOP button once.

The Combo Player is stopped.

Press the ►|| button to replay.

Press the STOP button twice.

The Combo Player is stopped completely.



At the completion of each movie a menu screen will appear. Be aware that the on-screen setup menu may damage your TV by permanently burning that image onto the screen if it is left on the screen for too long. To avoid this, press the STOP button at the completion of each movie. You may also decide to setup the SCREEN SAVER function.

ADVANCED PLAYBACK

The Combo Player allows you to playback discs at various speeds.

TV SCREEN

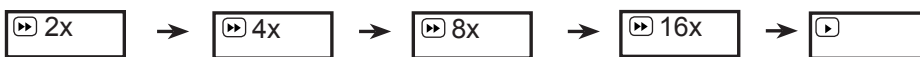
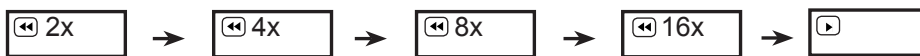

PLAYING AT 2X, 4X, 8X, OR 16X THE NORMAL SPEED

You can play back a disc at 2x, 4x, 8x, or 16x the normal speed.

Press the REW or FF button during playback.

The playback speed becomes 2x the normal speed.

The playback speed changes each time you press the REW or FF button.

REW: Fast reverse ◀◀

FF: Fast forward ▶▶

Press ►|| to resume normal playback.



- The Combo Player may not playback sound during scan reverse or forward playback of DVD video discs. The Combo Player will play sound during fast forward or fast reverse playback of audio CDs.
- The speeds may vary slightly from disc to disc and the 2x, 4x, 8x, and 16x speeds are only approximate speeds.

PLAYING IN SLOW-MOTION

A disc can be played back in slow-motion.

Press the ►► or ◀◀ button while playback is paused.

Press ►|| button to resume normal playback.

NOTICE

- During the slow-motion playback, the sound may not be heard.
- Some discs do not utilize this feature.

RESUMING PLAYBACK FROM THE SAME LOCATION

This Combo Player allows you to stop playback and continue playback later from the same location on the disc.

1. Press the STOP button

This will interrupt the playback and the Combo Player will memorizes the location where you stopped playback.

2. Press the ►|| button

The Combo Player will resume the playback from the location where you stopped playback.

NOTICE

- The following action will cancel the RESUME function:
 - Powering off the Combo Player after you stop playback.
 - Ejecting the disc.
- Depending on the disc, you may experience a difference of location where playback resumes.
- Some discs do not utilize this feature.

Locating a Specific Title, Chapter or Track

THE DVD VIDEO DISCS ARE NORMALLY DIVIDED INTO TITLES. THE TITLES ARE SUB-DIVIDED INTO CHAPTERS. MOREOVER, AUDIO CD AND MP3 CD ARE DIVIDED INTO TRACKS. YOU CAN CONVENIENTLY LOCATE ANY SPECIFIC TITLE, CHAPTER, OR TRACK WITH THIS COMBO PLAYER.

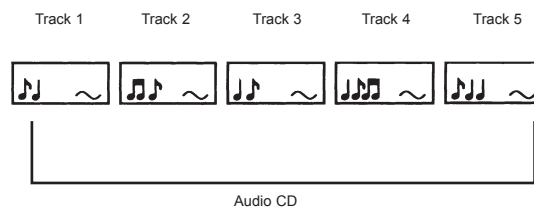
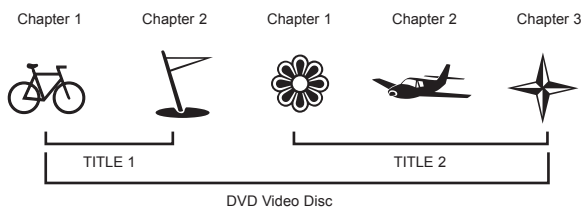

LOCATING A TITLE USING THE TITLE MENU

You can locate a specific title using the title menu function, if a DVD video disc contains a title menu.

1. Press the TITLE button

On the TV screen, the title menu will appear.

2. Press the ▲/▼/◀/▶ button to select the title you want

You can also directly locate a specific title by pressing its assigned number with the number buttons.

3. Press the ENTER button

This will cause the Combo Player to start playback from chapter 1 of the title selected.

NOTICE

- You may find that some discs will not respond to this function.
- If different instructions appear on the TV screen, follow those instructions. The instructions above are describing the basic procedure. Procedures may vary depending on the contents of the DVD video disc.

LOCATING A SPECIFIC CHAPTER OR TRACK

This Combo Player allows you to locate consecutive chapters or tracks.

Press the **◀◀** or **▶▶** button repeatedly to display the requested chapter or track.

The Combo Player starts playback from the selected chapter or track.

How to locate preceding chapters or tracks

- When you press the PREV **◀◀** button, the Combo Player starts playback from the beginning of the preceding chapter or track.

How to locate succeeding chapters or tracks

- When you press the NEXT **▶▶** button, the Combo Player starts playback from the beginning of the succeeding chapter or track.

On some discs the titles may not display the sub-divided chapters.

LOCATING A TITLE

You also can locate a specific title by directly selecting a title number.

1. Press SEARCH button during playback.

A menu will appear.

2. Press direction buttons and numbers to select the title and chapter you want to proceed to.

3. Move the cursor to select Audio, Subtitle, Angle, TT Time, CH Time, Repeat, Time Disp..



NOTICE

- The displays may vary depending on the discs.
- You may experience a difference in TITLE or MENU display.

Using the On-Screen Display

THE COMBO PLAYER ALLOWS YOU TO VIEW THE OPERATIONAL STATUS AND DISC INFORMATION ON YOUR TV SCREEN.

CHECKING THE OPERATIONAL STATUS

With this function you can view on your TV the following:

- Current title
- Track number
- Total playing time

Press DISPLAY during playback

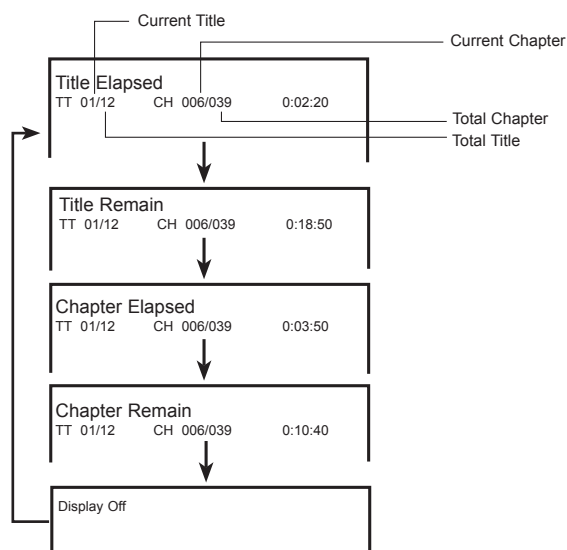

TO TURN OFF THE ON-SCREEN DISPLAY
Press DISPLAY repeatedly until
DISPLAY OFF appears on TV screen.

Playing Repeatedly

THIS Combo Player ALLOWS YOU TO PLAYBACK A SPECIFIC TITLE, CHAPTER, TRACK, OR SEGMENT REPEATEDLY. (TITLE REPEAT, CHAPTER/TRACK REPEAT, A-B REPEAT).

HOW TO REPEAT A TITLE, CHAPTER, OR TRACK

1. PLAY the title, chapter, or track you want to repeat.
2. Press the REPEAT button.

The repeat mode changes each time you press the REPEAT button.

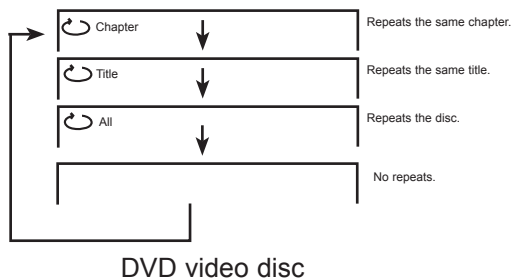

HOW TO REPEAT A SPECIFIC SEGMENT

1. Press the A-B RPT button at the beginning of the segment in which you want to repeat playback. (point A)
2. Press the A-B RPT button again at the end of the segment (point B).

The Combo Player will automatically return to point A and start to repeat playback of the selected segment (A-B).

3. Press the A-B RPT button to cancel the A-B repeat function.

The Combo Player will resume to normal playback.

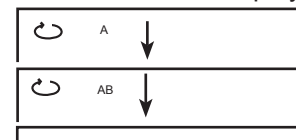

- Depending on the disc, you may experience a difference between point A and the location where playback actually resumes.
- Be aware that some discs will not respond to the A-B repeat function.

Playing in Random Order

THIS COMBO PLAYER ALLOWS YOU TO PLAYBACK TITLES, CHAPTERS WITHIN A TITLE, OR TRACKS IN RANDOM ORDER. (RANDOM PLAYBACK)

PLAYING TITLES IN RANDOM ORDER

This Combo Player will automatically choose the titles in a DVD video disc and play them back in random order.

1. Press the SHUFFLE button .

The Combo Player will now start random playback.

2. TO RESUME NORMAL PLAYBACK.

Press the SHUFFLE button again during random playback.

- The Combo Player will go to another chapter or track and start playback if you press the SKIP ►► button during random playback.

Zooming a Picture On DVD

ZOOMING A PICTURE

This Combo Player allows you to zoom into a picture as well as shift the zoom point.

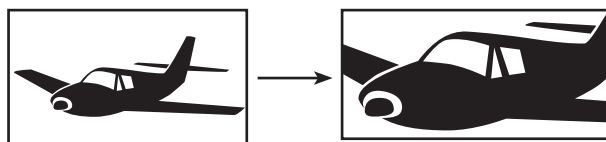

Press ZOOM during playback.

The Combo Player magnifies in the center of the picture.

Press the ZOOM button repeatedly to change the magnification factor.

If you press ▲/▼/◀/▶ during zoom playback, the zoom point shift.

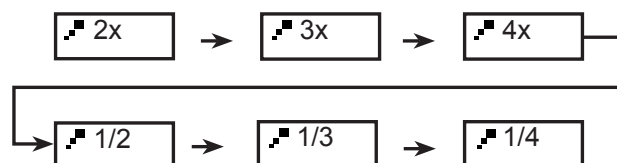

TO RESUME NORMAL PLAYBACK.

Press ZOOM repeatedly during zoom playback until the player resumes normal playback.

Selecting The Camera Angles/ Language / Audio Settings

THIS COMBO PLAYER ALLOWS YOU TO SELECT FROM SEVERAL DIFFERENT ANGLES AND LANGUAGES.

HOW TO CHANGE THE CAMERA ANGLE

Press the ANGLE button while playing back a scene recorded with multiple angles.

Each time you press the ANGLE button, the angle will change.

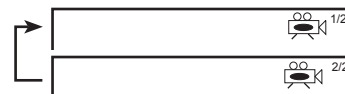
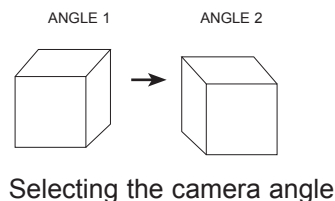

NOTICE

- The angle function will not work on DVD video discs that do not contain recorded multiple angles.
- The angle icon indicator will illuminate while playing back a title that contains at least one scene recorded with multiple angles.

HOW TO SELECT A PLAYBACK AUDIO SETTING

This Combo Player allows you to select a preferred language and sound recording system from those included on the DVD video disc.

1. Press the AUDIO button during playback.

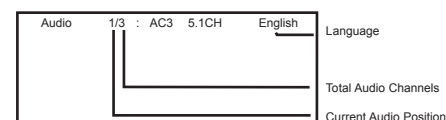

2. Press the AUDIO button again to cycle backwards.

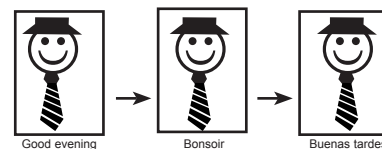
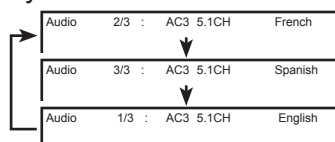

Selecting a language

NOTICE

- The player returns to the initial default settings, when you turn on the Combo Player or replace a disc.

Selecting Subtitles

THIS COMBO PLAYER ALLOWS YOU TO DISPLAY THE SUBTITLES FROM THOSE INCLUDED ON THE DISC, ON TO YOUR TV SCREEN.

HOW TO DISPLAY SUBTITLES

You have the option to select a preferred subtitle from those included on the DVD video disc.

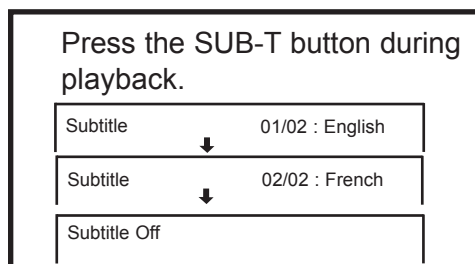

To TURN OFF the subtitles.

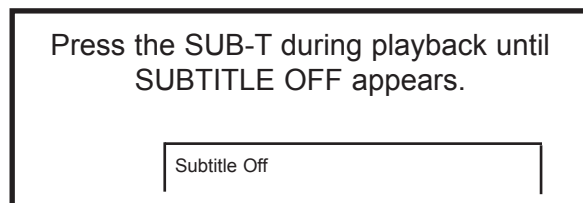

NOTICE

- With some DVDs, you may not be able to turn off the subtitles and they will appear on screen automatically.
- As you press the SUB-T button, the subtitles may not appear immediately during some scenes.
- If the subtitles continue to show on your TV even after the DVD has been turned off, please refer to the TV's close caption settings.

Playing in a Favorite Order





COMBINE YOUR FAVORITE TITLES, CHAPTERS, OR TRACKS AND PLAY THEM BACK IN ANY ORDER.(PROGRAMMED PLAYBACK)

HOW TO SET TITLES, CHAPTERS, OR TRACKS IN A FAVORITE ORDER

The program playback function will automatically playback titles, chapters or tracks in the order preprogrammed.

1. Insert a disc, then press the PROGRAM button.
At this time, the menu will appear.

Program: TT(XX) CH(XX)	
01 TT: CH:	06 TT: CH:
02 TT: CH:	07 TT: CH:
03 TT: CH:	08 TT: CH:
04 TT: CH:	09 TT: CH:
05 TT: CH:	10 TT: CH:
Exit	NEXT 

2. Using the the numerical buttons to enter numbers and the /// buttons to navigate the screen and to make changes, select the items in the order you want them programmed in.

Program: TT(XX) CH(XX)	
01 TT:05 CH:12	06 TT: CH:
02 TT:02 CH:07	07 TT: CH:
03 TT:04 CH:07	08 TT: CH:
04 TT: CH:	09 TT: CH:
05 TT: CH:	10 TT: CH:
Exit	Start NEXT 

To clear the numbers that you have programmed in just now, press CLEAR button.

3. Highlight START at the bottom of the screen and press ENTER button to confirm that programmed playback will commence.
The Combo Player starts memory playback.





To CHANGE the programmed item:
Press the STOP button, then follow step 1.

To CANCEL the programmed item:
Press the STOP button, then press the  button.

- When the Combo Player is turned off, or if the disc is removed, the program item will be removed.
- Depending on the disc, the programmed playback may not function.
- The program function supports to play normal CD's, it is not available while playing MP3 CD's and WMA.

MP3 Operation

PLAYING AN MP3 FORMAT

1. To play MP3 files, you must use the TV in order to be able to navigate the MP3 folders (group of MP3 songs) and files (songs) to select which ones you want to play. Insert an MP3 CD, the Combo Player will initialize the disc when the tray is closed and the directory (folder) will be shown in an MP3 MENU on screen.
2. Press / then the / key to select and highlight an MP3 file (song). Press ENTER to commence playback of a MP3 file (song) you have selected.

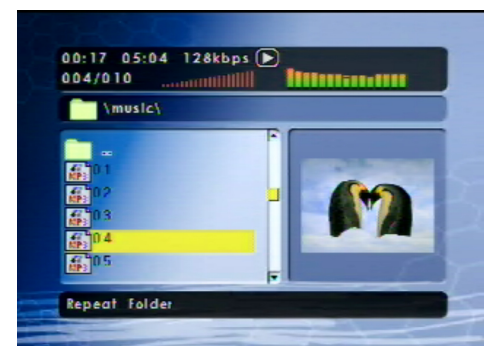

PLAYING A WMA FORMAT

1.To play WMA files, you must use the TV in order to be able to navigate the WMA folders (group of WMA files) and files to select which ones you want to play. Insert a WMA CD, the Combo Player will initialize the disc when the tray is closed and the directory (folder) will be shown in a WMA MENU on screen.

2.Then press ◀/▶ then the ▲/▼ key to select and highlight a WMA file (song).

Press ENTER to commence playback of a WMA file you have selected.

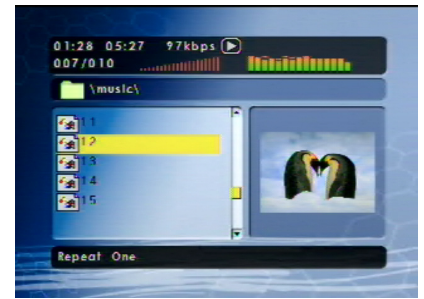

Playing With Your JPEG Files

PLAYING YOUR JPEG FILES

Normal Slide Show Presentation

When a JPEG disc is loaded into the player, a menu will appear on screen. Each picture in the current directory will be displayed consecutively in a slideshow presentation. Use the ▲/▼/◀/▶ buttons to select a folder or image you want to view and then press ENTER button to confirm your selection. Fifteen slideshow “transition” modes are provided. Use PROGRAM key to select.

NONE:(by default)

mode 1: WIPE TOP

mode 2: WIPE BOTTOM

mode 3: WIPE LEFT

mode 4: WIPE RIGHT

mode 5: DIAGONAL WIPE LEFT TOP

mode 6: DIAGONAL WIPE RIGHT TOP

mode 7: DIAGONAL WIPE LEFT BOTTOM

mode 8: DIAGONAL WIPE RIGHT BOTTOM

mode 9: EXTEND FROM CENTER H

mode 10: EXTEND FROM CENTER V

mode 11: COMPRESS TO CENTER H

mode 12: COMPRESS TO CENTER V

mode 13: WINDOW H

mode 14: WINDOW V

mode 15: WIPE FROM EDGE TO CENTER

RANDOM

IMAGE ROTATION

There are four modes to rotate a picture: Invert, Mirror, Left, and Right. These operations are allowed only when a picture is being displayed normally, and will be cancelled automatically when a new picture is displayed. The direction buttons are used to select the different rotation modes:

Up ▲ -Invert/Normal

Left ◀ -Turn left

Down ▼ -Mirror/Normal

Right ▶ -Turn right

ZOOM

This feature allows you to view a picture at 50%-200% in several increments. Press the ZOOM button. An on screen message (“Zoom 100%”) will verify your selection. Use ►► and ◀◀ keys to control the zoom level. Press the direction keys (▲/▼/◀/▶) to move the picture in any direction. Once you ZOOM a picture, the slide show is stopped. To resume the slide show, simply press the ►|| button.

Note: When in the ZOOM mode, the slideshow transition and image transformation features are disabled.

Memo On Output Sounds

DISCS AND OUTPUT SOUNDS

Sound recording system	DVD Video Discs											CD		MP3 CD	
	Dolby Digital			MPEG 2			Linear PCM					PCM44.1kHz		MP3	
	SPDIF /RAW	SPDIF /PCM	ANALOG	SPDIF /RAW	SPDIF /PCM	ANALOG	48kHz	ANALOG	SPDIF /RAW	SPDIF /PCM	ANALOG	SPDIF /RAW	ANALOG	SPDIF /RAW	ANALOG
Audio setting on the setting screen	SPDIF /RAW	SPDIF /PCM	ANALOG	SPDIF /RAW	SPDIF /PCM	ANALOG	SPDIF /RAW SPDIF /PCM	ANALOG	SPDIF /RAW	SPDIF /PCM	ANALOG	SPDIF /RAW SPDIF /PCM	ANALOG	SPDIF /RAW SPDIF /PCM	ANALOG
ANALOG AUDIO OUT jacks	—	—	o	—	—	o	—	o	—	—	o	—	o	—	o
DIGITAL AUDIO OUT jack	Dolby Digital bitstream	PCM (48kHz)	—	MPEG 2 bitstream	PCM (48kHz)	—	PCM (48kHz)	—	PCM (48kHz)	—	—	PCM (44.1kHz)	—	PCM (44.1kHz)	—

MPEG 1 AUDIO LAYER 3 DISC (MP3)

MP3 Audio Disc Play Back Capable

MP3 audio disc can be played back by operating the unit in the same way as the audio CD.

Setting the Parental Lock

YOU CAN USE THE PARENTAL LOCK FUNCTION ONLY WITH DVD VIDEO DISCS EQUIPPED WITH THE PARENTAL LOCK FEATURE.

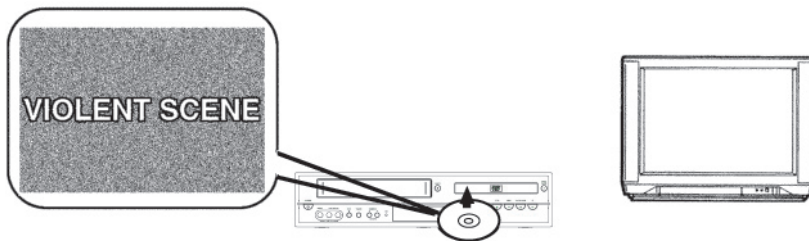

SETTING THE PARENTAL LOCK

DVD video discs equipped with the parental lock function are rated according to their content. The contents allowed by a parental lock level and the way a DVD video disc can be controlled may vary from disc to disc. For example, if the disc allows, you can edit out violent scenes unsuitable for children and replace them with more suitable scenes, or lock out playback of the disc all together.

1. Press STOP twice during playback.
2. Press SETUP

The SETUP MENU appears on the TV screen.

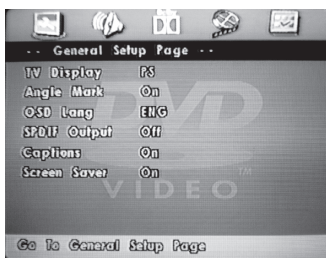

3. Use the ◀/▶ buttons to highlight the PREFERENCE PAGE menu and then press ENTER button to go to this page.

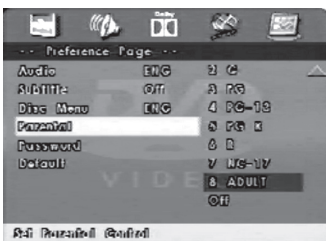

4. Scroll through the menu by pressing the ▲ or ▼ buttons and highlight PARENTAL. Press the ENTER button to enter this menu.
5. Highlight the rating level you want to switch to and press the ENTER button.
6. Now you will need to enter a password to be able to change the rating level. The factory preset password is **3308**. Enter it using the numerical buttons and press the ENTER button to confirm the rating level change. See next section for information on changing the preset password.

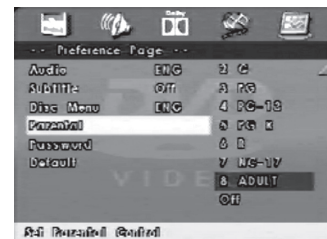

TO CHANGE YOUR PASSWORD:

1. Follow steps 1 to 3 in the previous section.
2. Scroll through the menu by pressing the ▲ or ▼ buttons and highlight PASSWORD and press the ENTER button. Press the ENTER button again to select CHANGE option.
3. Enter old password.
4. Enter new password.
5. Re-enter to confirm your new password.
6. Press ENTER.
7. Press SETUP.

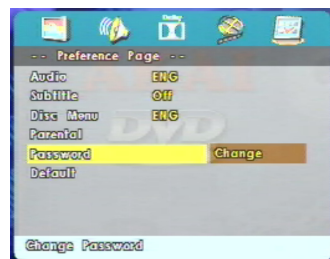

Customizing the Function Settings

THIS COMBO PLAYER ALLOWS YOU TO CUSTOMIZE THE PERFORMANCE TO YOUR PERSONAL PREFERENCE.

DISPLAYING THE SETUP MENU SCREEN

The SETUP MENU screen asks you to select a setting category from General Setup, Speaker Setup, Dolby Digital Setup, Video Setup and Preferences. The selected category will provide you the setting details on-screen.

1. Press SETUP.
2. Press ▲/▼/◀/▶ to select category (highlight), then press ENTER.
3. Press SETUP to return to normal playback.

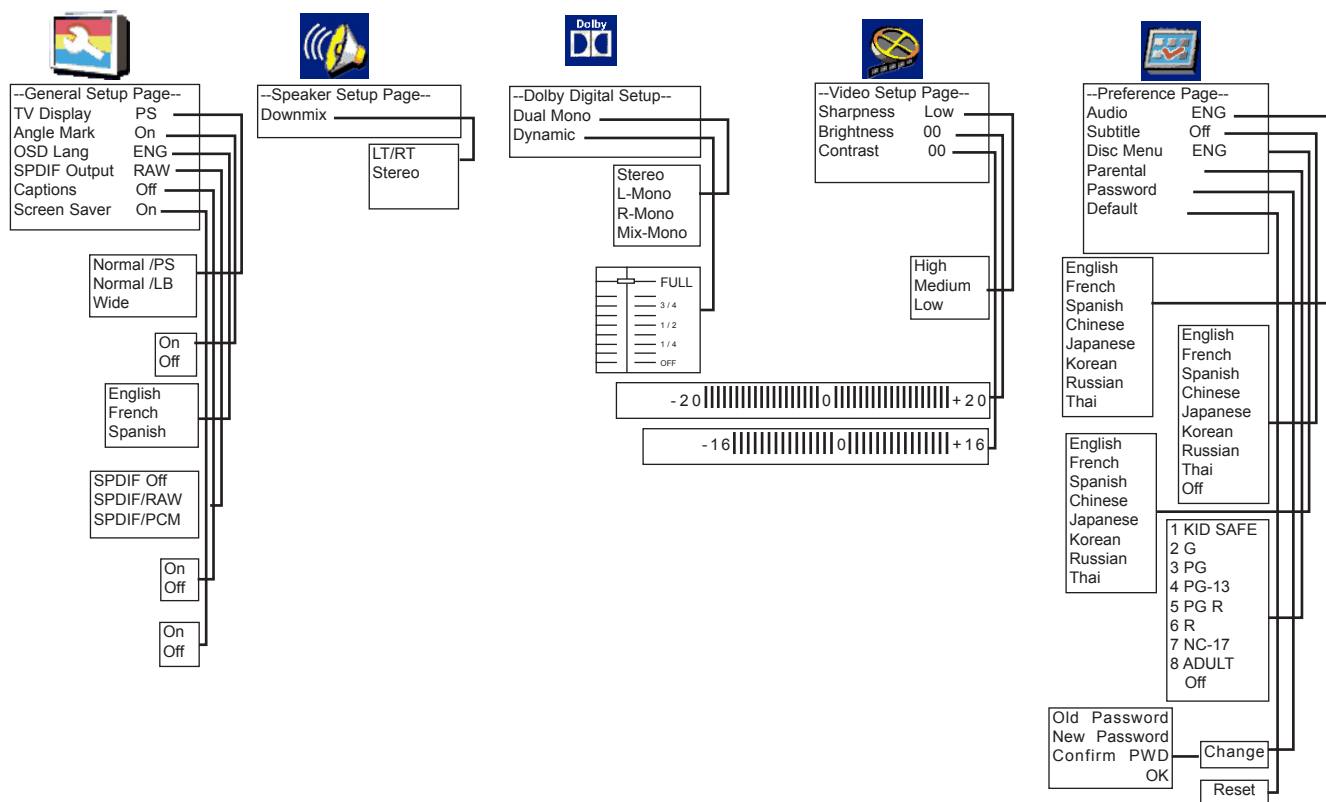

NOTICE

- Preset password is **3308**.
- The SETUP MENU screen disappears if you press the SETUP button while it is displayed.
- Any button can disable Screen Saver except the POWER button. After that, you can press some button to make the relative operation.
- Functions and menu are subject to change without notice.
- You must remove any/all disc from the player in order to access Preference Page.

SYMPTOMS AND CORRECTION

D V D	No power	<ul style="list-style-type: none"> • Connect the power plug into the wall outlet securely. • Check if the child lock is released.
	The player does not respond to the remote control.	<ul style="list-style-type: none"> • Check if the power plug is connected to an AC outlet. • Check the batteries in the remote control. • Aim the remote control directly at the remote sensor. If necessary, remove all the obstacles between the sensor and the remote. • You have to be within 7m of the player.
	No picture	<ul style="list-style-type: none"> • Verify the connection from the video output of the player to the TV video input. Then switch TV to appropriate mode. • Connect the video cable into the jacks securely. Refer to your television owners manual.
	No sound	<ul style="list-style-type: none"> • Connect the audio cables into the jacks securely. • Verify the connection from the DVD audio output to the TV or receiver audio input. Then switch to the appropriate source on the receiver. Refer to your audio amplifier owners manual.
V C R	LED no playtime display	<ul style="list-style-type: none"> • Check if the player is in VCR mode or DVD mode. • Check if the player is in counter status. Press the COUNTER/CLOCK button to switch.
	Timer recording failure	<ul style="list-style-type: none"> • make sure the timer recording is set correctly. • Make sure power is off. • Make sure the DVD/VCR clock is set correctly.
V C R	Cannot go into Record mode.	<ul style="list-style-type: none"> • Make sure the tape has a safety tab. If needed, cover the hole with cellophane tape.
	Playback picture is partially noisy	<ul style="list-style-type: none"> • Adjust tracking control for a better picture by pressing the TRACKING+/- button.
	Cannot view a tape but the audio is OK.	<ul style="list-style-type: none"> • Head cleaning may be necessary.
	No or poor playback picture	<ul style="list-style-type: none"> • Select channel 3 or 4 on your TV. • Fine tune your TV.
	TV programs cannot be seen normally.	<ul style="list-style-type: none"> • Check the ANT.IN and RF OUT connections. • Press the VCR button on the remote control.
	Video or color fades in and out when making a copy of a video tape.	<ul style="list-style-type: none"> • You cannot copy a copyrighted video tape. You are experiencing copy guard protection.
	Cannot remove the tape	<ul style="list-style-type: none"> • Check if the player is in the VCR mode. If not, press the VCR button to switch the mode.
D V D	Black & White picture	<ul style="list-style-type: none"> • Damaged S-Video connector (bent pin)
	The playback picture has occasional distortion	<ul style="list-style-type: none"> • A small amount of picture distortion may appear because of a poor quality video/sound transfer to disc. This is especially true of some discs manufactured between 1997-1998. • Scratched disc
	Brightness is unstable or noises are produced on playback pictures	<ul style="list-style-type: none"> • Connect the player directly through the TV and not through any other source. What you're viewing is the effect of the copy protection circuitry required on all combo players.
	The Combo Player does not start playback	<ul style="list-style-type: none"> • Place the disc with the graphics side up. • Place the disc on the disc tray correctly inside the guide. • Make sure the disc is free from scratches & fingerprints. • Press the SETUP button to turn off the menu screen. • Cancel the parental lock function or change the parental lock level. (The Pre-set password is 3308.) • Turn the power off then disconnect the power plug and reinsert it back into the wall. Retry again. • Use region 1 discs only.
	MP3 won't read disc or it skips	<ul style="list-style-type: none"> • Return disc as the software edition used may not be compatible with the player. Check web site for instruction.

Specifications

Power supply	120V~ 60 Hz
Power consumption	25W
Weight (Approx.)	5.7 kg
External dimensions	430 x 91 x 365 mm (W/H/D)
Signal system	NTSC
Operative temperature	+5°C~35°C
Installation condition	Horizontal/Relative humidity under 80%
Received channels	VHF:2-13 CH /UHF:14-69CH/Cable:1-125
RF Input/output	U/V-mixed:75Ω unbalanced
Video input	1.0 V (p-p), 75 Ω unbalanced RCA JACK
Audio input	-8.8 dBm,RCA JACK
RF output	3 or 4 CH
Video output	1.0 V (p-p), 75 Ω RCA JACK
S video output	(Y) 1.0 V (p-p), 75 Ω negative sync., Mini DIN 4-pin x 1 (C) 0.286 V (p-p), 75 Ω
Component video output	(Y)1.0V (p-p), 75 Ω (Pb)0.7V (p-p), 75 Ω (Pr)0.7V (p-p), 75 Ω
Audio output(DVD analog audio)	1.8±0.2V(p-p)(rms),10k Ω , pin jack(L,R)x 1
Audio output(VCR analog audio)	-5.8±2 dBm,RCA JACK
Playable tape	Very high dense tapes with VHS marks
Tape speed	SP:33.35mm/s, SLP:11.12mm/s
Playtime	SP:2hrs, SLP:6hrs(use of T-120 tape)
Clock display	12 hrs AM/PM
FF/REW time(VCR)	<220seconds (T-120 tape)

MAGNASONIC HOME ENTERTAINMENT WARRANTY

We appreciate your purchase of a MAGNASONIC Home Entertainment product. We take pride in the quality of our products and have manufactured your new Home Entertainment unit to exacting quality standards. We feel confident that in normal use, it will provide you with satisfactory performance. However, should you experience difficulty, you are protected under the provisions of this warranty. MAGNASONIC Home Entertainment products are warranted against manufacturing defects in materials and workmanship in normal use for the following period from the date of purchase by the original user, and is conditional upon the unit being installed and used as directed in the instruction manual.

PRODUCT	PARTS AND LABOUR
D.V.D. / VCR	1 year
Video Head	6 months
Remote Control	90 days

MAGNASONIC's obligation under this warranty shall be limited to the repair, including all necessary parts and the cost of the labour connected therewith, or at our option the exchange of any Home Entertainment product which shows evidence of a manufacturing defect within the warranty period. Replacement parts, furnished in connection with this warranty shall be warranted for a period equal to the unexpired portion of the original equipment warranty.

CUSTOMER OBLIGATIONS

This warranty applies to the product from the original date of purchase at retail. Therefore, the owner must provide a copy of the original, dated bill of sale. No warranty service will be performed without a bill of sale. Transportation to and from the service depot is the responsibility of the owner.

WARRANTY EXCLUSIONS

This warranty is extended to MAGNASONIC Home Entertainment products purchased and used in Canada. This warranty shall not apply to appearance or accessory items including but not limited to: antenna, cabinet, cabinet parts, knobs, batteries, connecting cables, cassette tapes, compact discs. This warranty shall, in addition, not apply to damages due to handling, transportation, unpacking, set-up, installation, customer adjustments that are covered in the instruction book, repair or replacement of parts supplied by other than the MAGNASONIC authorized service depot, any malfunction or failure caused by or resulting from abnormal environmental conditions, improper unauthorized service, improper maintenance, modifications or repair by the consumer, abuse, misuse, neglect, accident, fire, flood, or other Acts of God, and incorrect line voltage.

This Home Entertainment product is only warranted to the original retail purchaser. This warranty becomes void in the event of commercial or rental use. This warranty becomes void in the event serial numbers are altered, defaced or removed.

MAGNASONIC reserves the right to make changes in design or to make additions to or improvements upon this product without incurring any obligation to install the same on products previously manufactured. The foregoing is in lieu of all other warranties expressed or implied and MAGNASONIC neither assumes nor authorizes any person to assume for it any other obligation or liability in connection with the sale or service of this product. In no event shall MAGNASONIC or its MAGNASONIC dealers be liable for special or consequential damage arising from the use of this product, or for any delay in the performance of this warranty due to cause beyond our control.

The purchaser may have other rights under existing provincial or federal laws, and where any terms of this warranty are prohibited by such laws, they are deemed null and void, but the remainder of the warranty shall remain in effect.

HOW TO OBTAIN SERVICE

Should this product require service, you may obtain specific information on how to obtain service by contacting the MAGNASONIC Dealer from whom this product was purchased, or by contacting us directly:

SONIGEM SERVICE

300 Alden Road
Markham, Ontario
L3R 4C1

PHONE: (905) 940-5089 FAX: (905) 940-2303
1-800-287-4871



Free Manuals Download Website

<http://myh66.com>

<http://usermanuals.us>

<http://www.somanuals.com>

<http://www.4manuals.cc>

<http://www.manual-lib.com>

<http://www.404manual.com>

<http://www.luxmanual.com>

<http://aubethermostatmanual.com>

Golf course search by state

<http://golfingnear.com>

Email search by domain

<http://emailbydomain.com>

Auto manuals search

<http://auto.somanuals.com>

TV manuals search

<http://tv.somanuals.com>