

Owner's Manual

Please read before using this unit.

DVD/CD Player

DP100MW8B B

MAGNAVOX

SMART. VERY SMART.

INSTRUCCIONES EN
ESPAÑOL INCLUIDAS.

Supplied Accessories

remote control (NB093UD)
• AA (1.5V DC)
battery x2
not supplied.



RCA audio/video cables
(WPZ0102TM018 /
WPZ0102LTE01)



owner's manual
(1VMN27853)

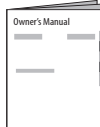

Connecting to RF Modulator (Not Supplied)

If your TV has antenna in jack only, it is still possible to connect this unit to your TV by using an RF modulator. In this case, follow the instructions below.

- 1) Disconnect the power cords of the devices from the AC outlet.
- 2) Make the connection as illustrated below.
- 3) **Set your RF modulator's channel 3/4 switch to either 3 or 4**, whichever the TV channel is least used in your area. If your RF modulator has a modulator/antenna switch, set it according to the manual supplied with the RF modulator.
- 4) Plug in the power cords of the devices to the AC outlet.
- 5) **Turn on your TV and choose the same channel as you set the RF modulator's channel 3/4 switch to.** For more details, follow the manual supplied with the RF modulator.

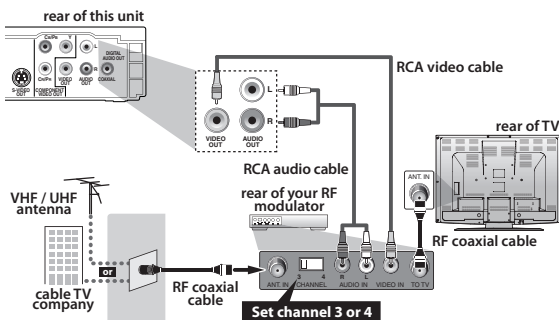

Note:

- RF modulator is not supplied with this unit. You need to purchase it at your local store.
- The quality of picture may become poor if this unit is connected to an RF modulator.

If you need additional operating assistance after reading this owner's manual, please call

TOLL FREE : 1-800-605-8610

or visit our web site at

<http://www.magnavox.com/support>

Contents

PRECAUTIONS

Safety Instructions	2
About the Discs	5
Playable Discs.....	5
Unplayable Discs.....	5

SETUP

Connections	6
Connection to a TV.....	6
Connection to an Audio System.....	7
Rear Terminals.....	7
About the Remote Control	8
Remote Control.....	8
Installing the Batteries for the Remote Control.....	8

DVD FUNCTIONS

Playback	9
MP3 Playback	10
Search Functions	10
Using Track Search.....	10
Using Title / Chapter Search.....	10
Using Time Search.....	10
On-Screen Display	11
Repeat / Random / Programmed Playback	12
Repeat Playback.....	12
Repeat A-B Playback.....	12
Random Playback.....	12
Programmed Playback.....	12
Special Settings	13
Subtitle Language.....	13
Audio Language.....	13
Camera Angles.....	13
Black Level Setting.....	13
Stereo Sound Mode.....	13
Virtual Surround.....	13
DVD Setting	14
LANGUAGE Setting.....	14
DISPLAY Setting.....	15
AUDIO Setting.....	15
PARENTAL Setting.....	16
OTHERS Setting.....	16
Reset to the Default Setting (Except for PARENTAL Setting).....	17

INFORMATION

Troubleshooting Guide	17
Specifications	18
LIMITED WARRANTY	18
Español	19
Quick Use Guide	Back Cover

PRECAUTIONS

SETUP

DVD FUNCTIONS

INFORMATION

Español

PRECAUTIONS

Safety Instructions

The model and serial numbers of this unit may be found on the cabinet.
You should record and retain those numbers for future reference.

Model No.: _____

Serial No.: _____

WARNING: TO REDUCE THE RISK OF FIRE OR ELECTRIC SHOCK, DO NOT EXPOSE THIS APPARATUS TO RAIN OR MOISTURE. APPARATUS SHALL NOT BE EXPOSED TO DRIPPING OR SPLASHING AND NO OBJECTS FILLED WITH LIQUIDS, SUCH AS VASES, SHALL BE PLACED ON THE APPARATUS.



CAUTION
RISK OF ELECTRIC SHOCK
DO NOT OPEN



The lightning flash with arrowhead symbol, within an equilateral triangle, is intended to alert the user to the presence of uninsulated "dangerous voltage" within the product's enclosure that may be of sufficient magnitude to constitute a risk of electric shock to persons.



The exclamation point within an equilateral triangle is intended to alert the user to the presence of important operating and maintenance (servicing) instructions in the literature accompanying the appliance.

CAUTION: TO REDUCE THE RISK OF ELECTRIC SHOCK, DO NOT REMOVE COVER (OR BACK). NO USER SERVICEABLE PARTS INSIDE. REFER SERVICING TO QUALIFIED SERVICE PERSONNEL.

The important note is located on the rear or bottom of the cabinet.

IMPORTANT SAFETY INSTRUCTIONS

1. Read these instructions.
2. Keep these instructions.
3. Heed all warnings.
4. Follow all instructions.
5. Do not use this apparatus near water.
6. Clean only with dry cloth.
7. Do not block any ventilation openings. Install in accordance with the manufacturer's instructions.
8. Do not install near any heat sources such as radiators, heat registers, stoves, or other apparatus (including amplifiers) that produce heat.
9. Do not defeat the safety purpose of the polarized or grounding-type plug. A polarized plug has two blades with one wider than the other. A grounding type plug has two blades and a third grounding prong. The wide blade or the third prong are provided for your safety. If the provided plug does not fit into your outlet, consult an electrician for replacement of the obsolete outlet.
10. Protect the power cord from being walked on or pinched particularly at plugs, convenience receptacles, and the point where they exit from the apparatus.
11. Only use attachments/accessories specified by the manufacturer.
12. Use only with the cart, stand, tripod, bracket, or table specified by the manufacturer, or sold with the apparatus. When a cart is used, use caution when moving the cart/apparatus combination to avoid injury from tip-over.
13. Unplug this apparatus during lightning storms or when unused for long periods of time.
14. Refer all servicing to qualified service personnel. Servicing is required when the apparatus has been damaged in any way, such as power-supply cord or plug is damaged, liquid has been spilled or objects have fallen into the apparatus, the apparatus has been exposed to rain or moisture, does not operate normally, or has been dropped.



FCC WARNING

This equipment may generate or use radio frequency energy. Changes or modifications to this equipment may cause harmful interference unless the modifications are expressly approved in the manual. The user could lose the authority to operate this equipment if an unauthorized change or modification is made.

RADIO-TV INTERFERENCE

This equipment has been tested and found to comply with the limits for a Class B digital device, pursuant to Part 15 of the FCC Rules. These limits are designed to provide reasonable protection against harmful interference in a residential installation. This equipment generates, uses, and can radiate radio frequency energy and, if not installed and used in accordance with the instructions, may cause harmful interference to radio communications. However, there is no guarantee that interference will not occur in a particular installation. If this equipment does cause harmful interference to radio or television reception, which can be determined by turning the equipment off and on, the user is encouraged to try to correct the interference by one or more of the following measures:

- 1) Reorient or relocate the receiving antenna.
- 2) Increase the separation between the equipment and receiver.
- 3) Connect the equipment into an outlet on a circuit different from that to which the receiver is connected.
- 4) Consult the dealer or an experienced radio/TV technician for help.

This Class B digital apparatus complies with Canadian ICES-003.

Cet appareil numérique de la classe B est conforme à la norme NMB-003 du Canada.

Disconnect the mains plug to shut off when find trouble or not in use. The mains plug shall remain readily operable.

CAUTION: Danger of explosion if battery is incorrectly replaced. Replace only with the same or equivalent type.
WARNING: Batteries (Battery pack or battery installed) shall not be exposed to excessive heat such as sunshine, fire, or the like.

LASER SAFETY

This apparatus employs a laser. Only a qualified service person should remove the cover or attempt to service this apparatus, due to possible eye injury.

CAUTION: Use of controls or adjustments or performance of procedures other than those specified herein may result in hazardous radiation exposure.

CAUTION: Visible and invisible laser radiation when open and inter lock defeated. Do not stare into beam.

LOCATION: Inside, near the deck mechanism.

IMPORTANT COPYRIGHT INFORMATION

Unauthorized copying, broadcasting, public performance and lending of discs are prohibited. This product incorporates copyright protection technology that is protected by U.S. patents and other intellectual property rights. Use of this copyright protection technology must be authorized by Macrovision, and is intended for home and other limited viewing uses only unless otherwise authorized by Macrovision. Reverse engineering or disassembly is prohibited.

Do not place the unit on the furniture that is capable of being tilted by a child and an adult leaning, pulling, standing or climbing on it. A falling unit can cause serious injury or even death.

To Avoid the Hazards of Electrical Shock and Fire

- Do not handle the power cord with wet hands.
- Do not pull on the power cord when disconnecting it from an AC outlet. Grasp it by the plug.
- Do not put your fingers or objects into the unit.

Location and Handling

- Do not install the unit in direct sunlight, near strong magnetic fields, or in a place subject to dust or strong vibration.
- Avoid a place with drastic temperature changes.
- Install the unit in a horizontal and stable position. Do not place anything directly on top or bottom of the unit. Depending on your external devices, noise or disturbance of the picture and/or sound may be generated if the unit is placed too close to them. In this case, please ensure enough space between the external devices and the unit.
- Depending on the environment, the temperature of this unit may increase slightly. This is not a malfunction.
- Be sure to remove the disc and unplug the AC power cord from the outlet before carrying the unit.

Dew Condensation Warning

- Dew condensation may form inside the unit in the following conditions. If so, do not use this unit at least for a few hours until its inside gets dry.
 - The unit is moved from a cold place to a warm place.
 - Under conditions of high humidity.
 - After heating a cold room.

Note about Recycling

- This unit's packaging materials are recyclable and can be reused. Please dispose of any materials in accordance with your local recycling regulations.
- Batteries should never be thrown away or incinerated but disposed of in accordance with your local regulations concerning chemical wastes.



Notice for Progressive Scan Output

- Consumers should note that not all high definition television sets are fully compatible with this product and may cause artifacts to be displayed in the picture. In case of picture problems with 525(480) progressive scan output, it is recommended that the user switch the connection to the 'standard definition' output. If there are questions regarding your TV set compatibility with this 525p(480p) DVD player, please contact our customer service center.

TRADEMARK INFORMATION



Manufactured under license from Dolby Laboratories. Dolby and the double-D symbol are trademarks of Dolby Laboratories.





Products that have earned ENERGY STAR® are designed to protect the environment through superior energy efficiency.

SYMBOLS USED IN THIS MANUAL

The following symbols appear in some headings in this manual.

 **DVD**: Description refers to DVD-video.

 **CD**: Description refers to audio CD.

 **MP3**: Description refers to CD-RW/-R with MP3 files.

MAINTENANCE

Servicing

- Please refer to relevant topics on the “Troubleshooting Guide” on page 17 before returning the unit.
- If this unit becomes inoperative, do not try to correct the problem by yourself. There are no user-serviceable parts inside. Turn off, unplug the power plug, and please call our help line mentioned on the front page to locate an authorized service center.

Cleaning the Cabinet

- Wipe the front panel and other exterior surfaces of the unit with a soft cloth.
- Never use a solvent, thinner, benzene or alcohol to clean the unit. Do not spray insecticide liquid near the unit. Such chemicals may discolor the surface or damage the unit.

Cleaning Discs

- When a disc becomes dirty, clean it with a cleaning cloth. Wipe the disc from the center to out. Do not wipe in a circular motion.
- Do not use solvents such as benzene, thinner, commercially available cleaners, detergent, abrasive cleaning agents or antistatic spray intended for analog records.

Cleaning the Disc Lens

- If this unit still does not perform properly although you refer to the relevant sections and to “Troubleshooting Guide” in this owner’s manual, the laser optical pickup unit may be dirty. Consult your dealer or an authorized service center for inspection and cleaning of the laser optical pickup unit.

Disc Handling

- When you handle a disc, hold it by its edge and try not to touch the surface of the disc.
- Always store the disc in its protective case when not in use.

© 2009 Funai Electric Co., Ltd.

All rights reserved. No part of this manual may be reproduced, copied, transmitted, disseminated, transcribed, downloaded or stored in any storage medium, in any form or for any purpose without the express prior written consent of Funai. Furthermore, any unauthorized commercial distribution of this manual or any revision hereto is strictly prohibited.

Information in this document is subject to change without notice. Funai reserves the right to change the content herein without the obligation to notify any person or organization of such changes.

FUNAI with the  design is a registered trademark of Funai Electric Co., Ltd and may not be used in any way without the express written consent of Funai. All other trademarks used herein remain the exclusive property of their respective owners. Nothing contained in this manual should be construed as granting, by implication or otherwise, any license or right to use any of the trademarks displayed herein. Misuse of any trademarks or any other content in this manual is strictly prohibited. Funai shall aggressively enforce its intellectual property rights to the fullest extent of the law.

About the Discs

Playable Discs

Type of media	Mark (logo)	Region code	Recorded signals	Disc size	Disc types
DVD-video *1, 2, 4, 6, 9			digital video (MPEG2)	5 inches (12 cm) or 3 inches (8 cm)	<p>e.g.) title 1 title 2 chapter 1 chapter 2 chapter 3 chapter 4 chapter 1 chapter 2</p>
DVD-RW DVD-R *1, 3, 4, 5, 6, 7, 8, 9		—			
DVD+RW DVD+R *1, 4, 5, 6, 8, 9		—			
audio CD *4, 6, 9		—	digital audio	5 inches (12 cm) or 3 inches (8 cm)	<p>e.g.) track 1 track 2 track 3 track 4 track 5 track 6</p>
CD-RW CD-R *4, 5, 6, 8, 9,		—	digital audio or MP3		<p>e.g.) folder 1 folder 2 file 1 file 2 file 3 file 4 file 1 file 2</p>

DVD is a trademark of DVD Format/Logo Licensing Corporation.

If you cannot play back a disc which bears one of the marks above, check the following notes.

- *1: This unit conforms to the NTSC color system. Discs recorded in other color systems such as PAL cannot be played back.
- *2: Certain DVD-video do not operate as described in this manual due to the intentions of the disc's producers.
- *3: Discs recorded in the VR (Video Recording) format cannot be played back.
- *4: Scratched or stained discs may not be played back.
- *5: Some discs cannot be played back because of incompatible recording conditions, characteristics of the recorder or special properties of discs.
- *6: You can play back discs which bear the marks above. If you use non-standardized discs, this unit may not play them back. Even if they are played back, the sound or video quality will be compromised.
- *7: Only the discs recorded in the video format and finalized can be played back. Unfinalized discs cannot be played back. Depending on the recording status of a disc, the disc may not be played back at all. The picture or sound may not be smooth, etc.
- *8: If the recorded portion of the disc is too small (smaller than $2\frac{3}{16}$ inches (55mm) across), it may not be played back.
- *9: Do not glue paper or put stickers on to the disc. These may damage the disc, and the unit may not read it correctly.

Unplayable Discs

NEVER play back the following discs as malfunction may result!

DVD-RAM / DVD-audio / CD-i / photo CD / video CD / DVD with region codes other than 1 or ALL / DTS-CD / DVD-ROM for personal computers / CD-ROM for personal computers / HD DVD / Blu-ray Disc

On the following disc, the sound MAY NOT be heard.

super audio CD

Any other discs without compatibility indications

Note:

- Only the sound recorded on the normal CD layer can be delivered. The sound recorded on the high density super audio CD layer cannot be delivered.

SETUP

Connections

Connection to a TV

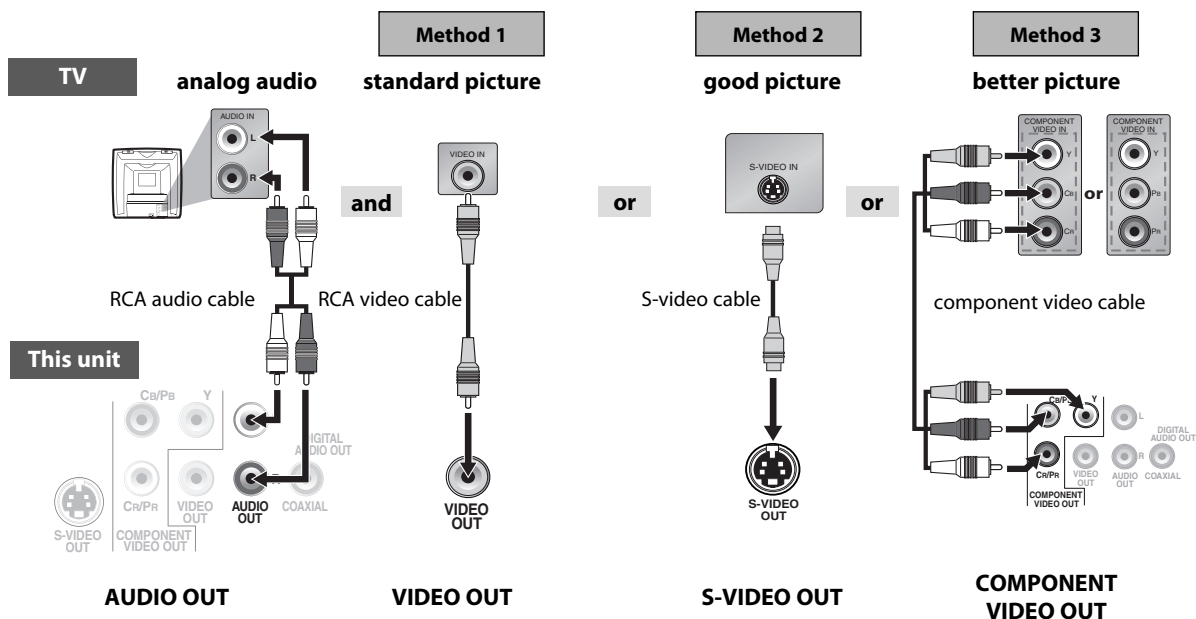

Supplied cables used in this connection are as follows:

- RCA audio cable (L/R) x 1
- RCA video cable x 1

Please purchase the rest of the necessary cables at your local store.

Note:

- Connect this unit directly to your TV. If RCA audio/video cables are connected to a VCR, pictures may be distorted due to the copy protection system.

If your TV is compatible with 525 (480) progressive scanning and you want to enjoy that high quality picture;

You must select the connection COMPONENT VIDEO OUT above and progressive scanning mode. To set the mode, set "PROGRESSIVE" to "ON" in "DISPLAY" menu. Refer to pages 14-15 for more details.

- When "PROGRESSIVE" is "ON", video signals from the unit's VIDEO OUT and S-VIDEO OUT jacks will be distorted or not be output at all.

If your TV is not compatible with progressive scanning:

Use this unit in interlace mode and set "PROGRESSIVE" to "OFF" either in "DISPLAY" menu or by pressing and holding [PLAY ►] on the front of the unit for more than 5 seconds.

After connecting to your TV:

You will need to switch to video input on your TV. This is usually marked TV/VIDEO, INPUT or AUX. Please refer to your TV's owner's manual for details.

Input modes for common TV brands:

Listed below are inputs for common brand name TV's.

Admiral:	AUX	Panasonic:	TV/VIDEO
Curtis Mathis:	LINE1, LINE2, 00, 90, 91, 92, 93	RCA:	INPUT, TV/VCR, 00, 90, 91, 92, 93
GE:	INPUT, TV/VCR, 00, 90, 91, 92, 93	Samsung:	TV/VIDEO
Hitachi:	INPUT, AUX	Sanyo:	VIDEO
JVC:	VIDEO, VIDEO1, VIDEO2, VIDEO3	Sharp:	00
Kenwood:	AUX	Sony:	VIDEO1, VIDEO2, VIDEO3
LXI-Series:	00	Toshiba:	TV/GAME
Magnavox:	AUX CHANNEL	Zenith:	00

Connection to an Audio System

Analog Audio Connection

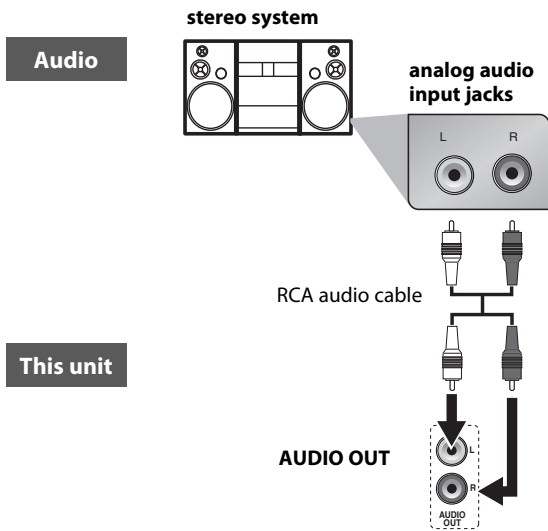

Digital Audio Connection

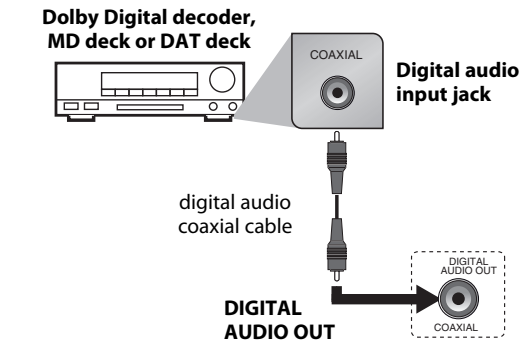

Connection	Setting	SETUP > AUDIO > DOLBY DIGITAL
Connecting to a Dolby Digital decoder for Dolby Digital audio output.		BITSTREAM
Connecting to the other device (an MD deck or DAT deck etc.) without Dolby Digital decoder.		PCM

* To complete these settings, refer to pages 14-15.

Note:

- The audio source on a disc in a Dolby Digital multi-channel surround format cannot be recorded as digital sound by an MD or DAT deck.
- By hooking this unit up to a Dolby Digital decoder, you can enjoy high-quality Dolby Digital multi-channel surround sound as heard in the movie theaters.
- Playing back a DVD using incorrect settings may generate noise distortion and may also damage the speakers.

Supplied cables used in this connection are as follows:

- RCA audio cable (L/R) x 1
- Please purchase the rest of the necessary cables at your local store.

Rear Terminals

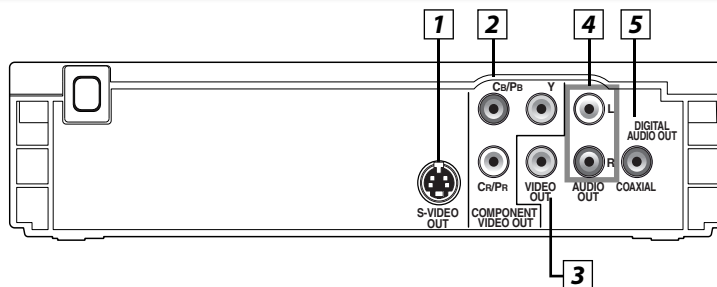

- 1 S-VIDEO OUT jack**
Connect an optional S-video cable here through the S-video in jack of a television.
- 2 COMPONENT VIDEO OUT jacks**
Connect optional component video cable here through the component video in jacks of a television.
- 3 VIDEO OUT jack**
Connect a yellow video cable here through the video in jack of a television.
- 4 AUDIO OUT jacks**
Connect an audio cable here through the audio in jacks of a television or other audio device.
- 5 DIGITAL AUDIO OUT COAXIAL jack**
Connect a digital audio coaxial cable here through the digital audio coaxial in jack of a decoder or audio receiver.

Note:

- Please purchase the necessary cables at your local store. (Refer to pages 6-7.)

About the Remote Control

Remote Control



Installing the Batteries for the Remote Control

Install batteries (AA x2) matching the polarity indicated inside battery compartment of the remote control.



*** Batteries not supplied.**

Keep in mind the following when using the remote control:

- Make sure that there are no obstacles between the remote control and the remote sensor on the unit.
- The maximum operable ranges from the unit are as follows.

- Line of sight:

approx. 23 feet (7m)

- Either side of the center:

approx. 16 feet (5m) within 30°

- Above: approx. 16 feet (5m) within 15°

- Below: approx. 10 feet (3m) within 30°

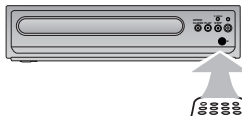

Note:

- Do not mix alkaline and manganese batteries.
- Do not mix old and new batteries.
- Always remove batteries from remote control if they are dead or if the remote control is not to be used for an extended period of time. This will prevent battery acid from leaking into the battery compartment.

Media	DVD	CD / MP3
Button (Alphabetical order)		
1 2 3 4 5 6 7 8 9 0	• To select chapter or title directly.	• To select track directly. (CD) • To select folder/file directly. (MP3)
ENTER	• To move the cursor and determine its position.	• To move the cursor and determine its position.
A-B	• To repeat between your chosen point of A and B.	• To repeat between your chosen point of A and B.
ANGLE	• To select camera angles on a disc.	—
AUDIO	• To select audio language on a disc.	• To select "STEREO", "L-ch" or "R-ch". (CD)
CLEAR	• To remove status number in program input. • To clear the numbers entered incorrectly. • To cancel the point for A-B repeat.	• To remove status number in program input. • To clear the numbers entered incorrectly. • To cancel the point for A-B repeat.
DISPLAY	• To display the current disc mode.	• To display the current disc mode.
REV FWD	• To search forward/backward through a disc. • To begin slow forward playback in the pause mode.	• To search forward/backward through a disc.
MENU	• To call up the menu on a disc.	—
MODE	• To arrange the playing order or play randomly. • To set black level on/off. • To set virtual surround on / off.	• To arrange the playing order or play randomly. • To set virtual surround on / off.
OPEN/CLOSE	• To open or close the disc tray. • To turn on the unit.	• To open or close the disc tray. • To turn on the unit.
PAUSE	• To pause disc playback. • To advance playback one frame at a time.	• To pause disc playback.
PLAY	• To begin disc playback. • To turn on the unit.	• To begin disc playback. • To turn on the unit.
REPEAT	• To play back a chapter or title repeatedly.	• To play back a track or disc repeatedly. (CD) • To play back a file, folder or disc repeatedly. (MP3)
RETURN	• To return to the previous operation in menu.	• To return to the previous operation in menu.
SEARCH MODE	• To search chapter, title or time.	• To search tracks. • To search time. (CD) • To search folders. (MP3)
SETUP	• To call up the setup menu.	• To call up the setup menu.
SKIP	• To skip chapters or titles.	• To skip tracks. (CD) • To skip folders or files. (MP3)
STANDBY-ON	• To turn the unit on or to turn the unit into the standby mode. (To completely turn off the unit, you must unplug the AC power cord.)	• To turn the unit on or to turn the unit into the standby mode. (To completely turn off the unit, you must unplug the AC power cord.)
STOP	• To stop playback.	• To stop playback.
SUBTITLE	• To select subtitles on a disc.	—
TOP MENU	• To call up the top menu on a disc.	—
ZOOM	• To magnify part of a picture. (2x / 3x / 4x / 1/2x)	—

DVD FUNCTIONS

Please note : most instructions in this manual refer to remote control use.

Playback

Before:

Turn on the TV, amplifier and any other device which are connected to this unit. Make sure the TV and audio receiver (not supplied) are set to the correct channel.

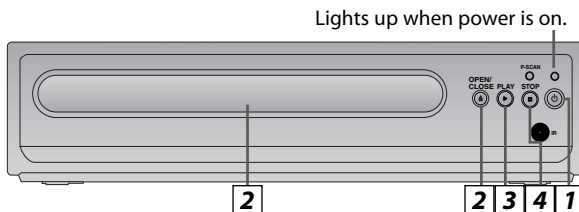
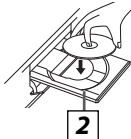

(MP3 ⇒ on page 10)

- 1 Press [STANDBY-ON] to turn on this unit.
- 2 Press [OPEN / CLOSE ▲] and insert a disc with label facing up.
- 3 Press [PLAY ►] to start playback.
- 4 Press [STOP ■] to stop playback.

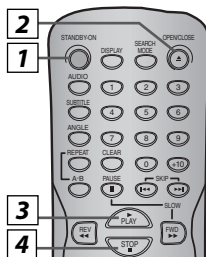

Note:

- When you play back a CD-RW-R with MP3 files, details on page 10.
- A "⊘" may appear at the top-right on the TV screen when the operation is prohibited by the disc or this unit.
- Some DVD may start playback from title 2 or 3 due to specific programs.
- During the playback of a 2-layered disc, pictures may stop for a moment. This happens while the 1st layer is being switched to the 2nd layer. This is not a malfunction.
- You can change the on-screen language in "PLAYER MENU" setting. (Refer to page 14.)

Disc Menu



Some discs contain menus which allow you to customize DVD playback. Use [▲ / ▼ / ◀ / ▶] to select an item, then press [ENTER] (or [PLAY ►]).

Calling Up a Menu Screen during Playback



- Press [MENU] to call up the disc menu.
- Press [TOP MENU] to call up the title menu.

Note:

- Menu operations may vary depending on the disc. Refer to the manual accompanying the disc for more details.

Resume Playback



Press [STOP ■] during playback. Resume icon will appear at the top-left on the TV screen. Press [PLAY ►], playback will resume from the point at which playback was stopped.

■ R.STOP

Note:

- To cancel resume, press [STOP ■] one more time in the stop mode.
- For MP3, playback will resume from where you stopped (if the power has been turned off, the playback will start from the beginning of the track).
- The resume playback information stays on even when the power is turned off, as long as the disc stays in the unit.

Paused and Step-by-Step Playback



Press [PAUSE II] during playback. To continue playback, press [PLAY ►].

■ PAUSE



The disc goes forward by one frame each time [PAUSE II] is pressed in the pause mode. To continue playback, press [PLAY ►].

Note:

- Set "STILL MODE" to "FIELD" in "DISPLAY" menu if pictures in the pause mode are blurred. (Refer to pages 14-15.)

Fast Forward / Reverse Search



Use [FWD ►►] or [REV ◀◀] repeatedly during playback to select the required forward or reverse speed.

To continue playback, press [PLAY ►].

◀◀ 1

Note:

- Fast forward or reverse search speed is different depending on the disc. Approximate speed is 1(2x), 2(4x), 3(8x), 4(16x) and 5(32x).

Slow Forward Search



Press [FWD ►►] repeatedly in the pause mode to select the required forward speed.

To continue playback, press [PLAY ►].

▶▶ 1

Note:

- Slow forward speed is different depending on the disc. Approximate speed is 1(1/32x), 2(1/16x), 3(1/8x), 4(1/4x) and 5(1/2x).
- Set "STILL MODE" to "FIELD" in "DISPLAY" menu if pictures in the slow playback mode are blurred. (Refer to pages 14-15.)
- The reverse of slow playback is not available.

Zoom



- 1) Press [ZOOM] repeatedly during playback to select the required zoom factor: 2x, 3x, 4x, 1/2x or off.



- 2) Use [▲ / ▼ / ◀ / ▶] to slide the zoomed picture across the screen.
- 3) To exit zoom function, press [ZOOM] repeatedly to select off.

Note:

- Zooming function does not work while the disc menu is displayed.
- Some part of the picture may not be zoomed depending on the disc or playback status.

MP3 Playback

MP3 is a method of compressing files. You can copy MP3 files on CD-RW/-R from the computer and play back the files on this unit.



Insert a CD-RW/-R with MP3 files, then the file list will automatically appear on the TV screen.

1 Select the desired folder from the list on the left side in the file list.

Press [ENTER] or [PLAY ▶].

2 Select the desired file from the list on the right side in the file list.

Press [ENTER] or [PLAY ▶].

Note:

- Some selections may take a while to be recognized.
- Folders are known as groups; files are known as tracks.
- MP3 files are accompanied by icon.
- Folders are accompanied by icon.
- Refer to "On-Screen Display" on page 11 for more details.
- If you record data over 20 times, it may not be played back correctly.

This unit recommends the files recorded under the following circumstances:

- Sampling frequency: 44.1kHz or 48kHz.
- Constant bit rate: 32kbps ~ 320kbps.

3 Refer to "Resume Playback" on page 9.



Search Functions

Using Track Search



Using [SEARCH MODE]

1 e.g.) CD

2 Enter the desired track number within 5 seconds.

3 Press [ENTER].

- To play back a double-digit track, press the track number directly (e.g. for track 14, press [1], [4] and [ENTER]).
- To play back a triple-digit track, press the track number directly for MP3. (e.g. for track 114, press [1], [1], [4] and [ENTER]).

Using [SKIP ◀◀, ▶▶]

1 Current Track

Note:

- For audio CD, track search is not available for programmed or random playback.

Using Title / Chapter Search



Using [SEARCH MODE]

1 or Press [SEARCH MODE] once for the title search. For the chapter search, press cursor [▶] to highlight .

2 Enter the desired title or chapter number within 5 seconds.

3 Press [ENTER].

Using [SKIP ◀◀, ▶▶]

1 Current Chapter

Note:

- Depending on the disc being played back, this function can also be performed by directly entering the desired chapter number with [the Number buttons]. Refer to the manual accompanying the disc.
- For DVD, title/chapter search is not available for programmed or random playback.

Using Time Search



1 e.g.) DVD

Press cursor [▶] to highlight .

CD: once
DVD: twice

2 Enter the desired time within 5 seconds.

e.g.) DVD

3 Press [ENTER].

Note:

- To play time 0:15:00, press [1], [5], [0], [0] of [the Number buttons].
- Press [CLEAR] to erase the incorrect input at step 2.
- For DVD and audio CD, time search is not available for programmed or random playback.

On-Screen Display

You can check the information about the current disc by pressing [DISPLAY] on the remote control.

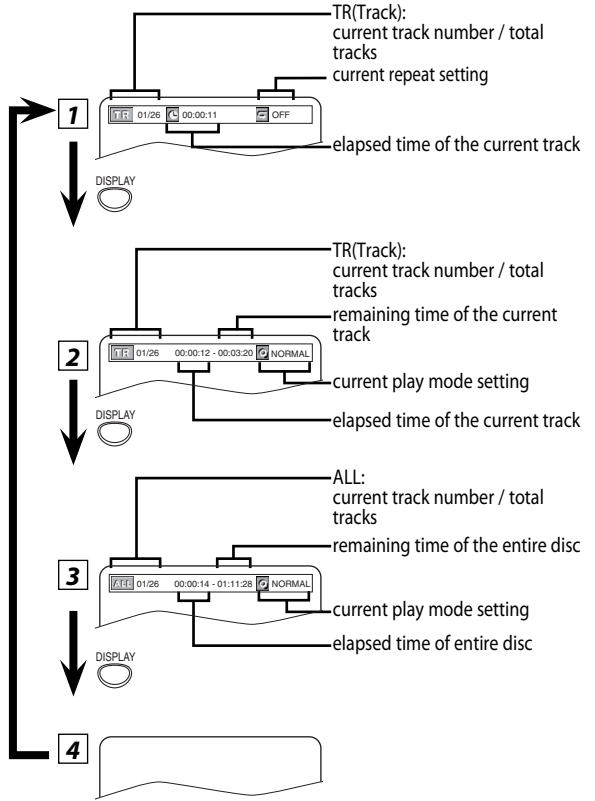
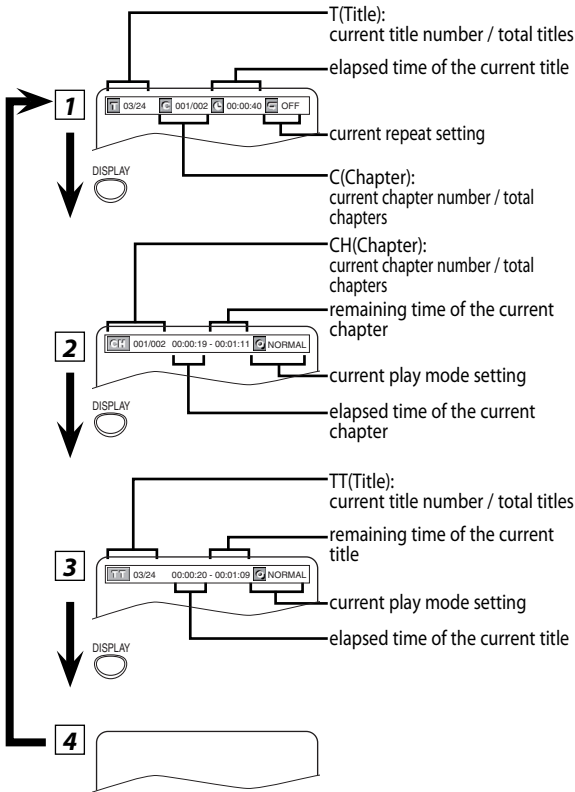

Note:

• Some DVD will not allow you to set chapter playback correctly.

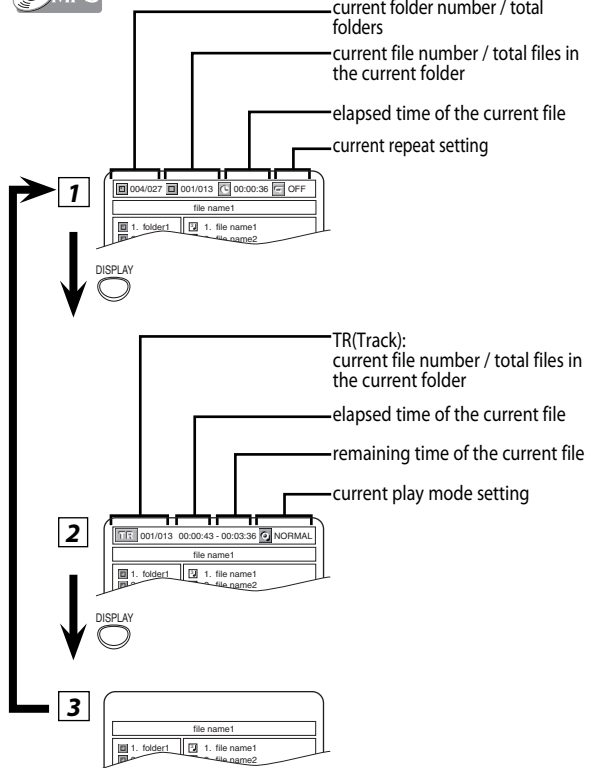

DVD FUNCTIONS

Repeat / Random / Programmed Playback

Repeat Playback



Repeat function is available only during playback.

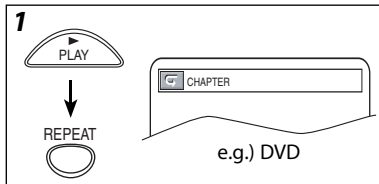

Each time you press [REPEAT], repeat function changes as example below.

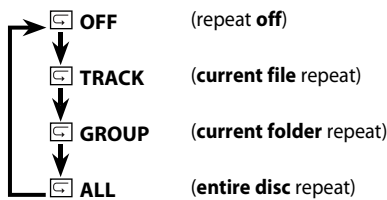
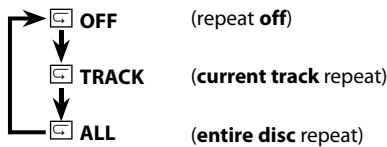
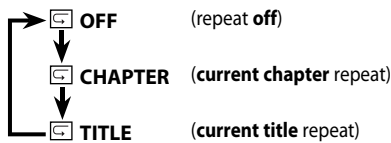

Note:

- Repeat setting (except "ALL") will be cleared when moving to another title, chapter, track/file or folder.
- This function is not available with some discs or during repeat A-B playback.

Repeat A-B Playback

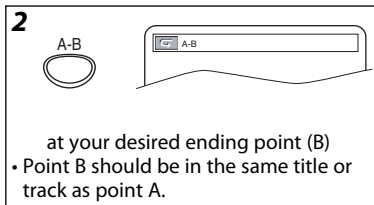
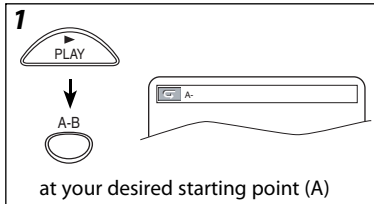

Note:

- To exit the sequence, press [A-B] so that "OFF" appears.
- To cancel point A, press [CLEAR] at step 1.
- This function does not work in the other repeat modes.

Random Playback



This function shuffles the playing order of chapters or tracks instead of playback in the sequence.

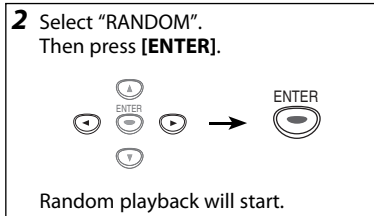
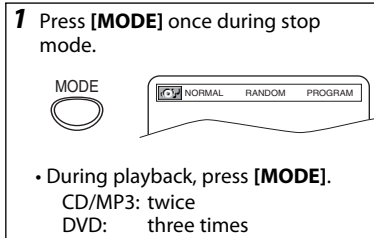

Note:

- During random playback, you cannot go back to the previous track, using [SKIP ►►] allows you to search chapters or tracks randomly.
- During DVD random playback, you can play back chapters in the current title randomly.
- Some DVD will not allow you to set random playback.

Programmed Playback



You may determine the order in which chapters or tracks will play back.

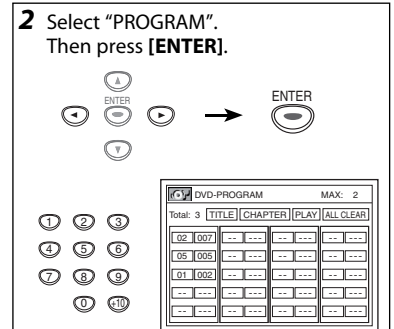
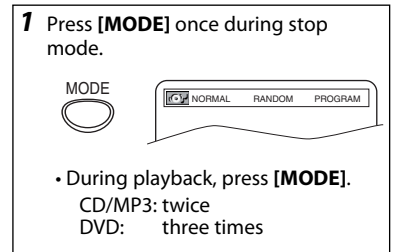

- Up to 20 chapters or tracks can be ordered.
- Enter the desired number with [the Number buttons].
DVD: title and chapter number
CD: track number
MP3: folder and file number

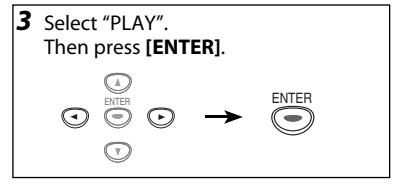

Note:

- To erase all program at once, select "ALL CLEAR" and press [ENTER] or press [CLEAR] at step 2.
- If the title, chapter, track number is incorrect, the programmed number you entered will be skipped during programmed playback.
- While a program is being played back, [STOP ■] works as follows; Press [STOP ■] and [PLAY ►] next, so that the programmed playback restarts. Press [STOP ■] twice and [PLAY ►] next, so that playback restarts from the first track in the original order. However, your programmed playback can be restarted when you follow the above steps. (Your programs are still stored until either the disc is removed or power is turned off.)
- Some DVD will not allow you to set programmed playback.
- During programmed playback, you cannot setup [TITLE] (DVD), [GROUP] (MP3).

Special Settings

Subtitle Language



This unit allows you to select a subtitle language (if available) during DVD playback.

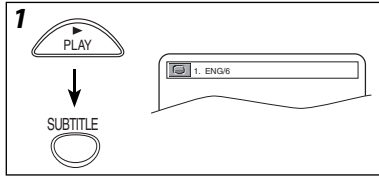

Each time you press [SUBTITLE], subtitle language changes as example below.

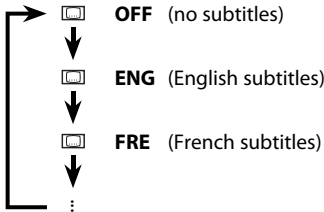

To set subtitle ON/OFF

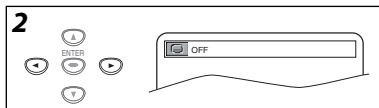
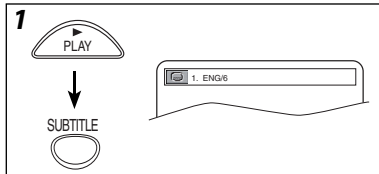

Note:

- If your language is not shown after pressing [SUBTITLE] several times, the disc may not have that language. However, some discs allow subtitle language setting on the disc menu. (Operation varies depending on the disc, so refer to the manual along with the disc.)
- When "⊘" appears on the TV screen, it means no subtitle is recorded on the scene.
- Some discs will only allow you to change the subtitle from the disc menu. Refer to the manual accompanying the discs for details.

Audio Language



This unit allows you to select an audio language (if multiple languages are available on disc) during DVD playback.

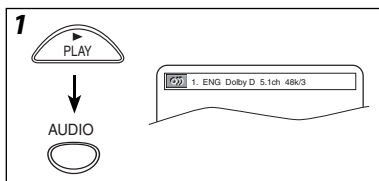

Each time you press [AUDIO], audio language changes as example below.

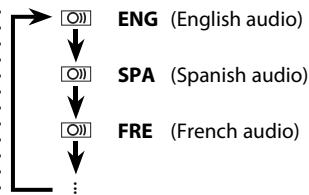



Note:

- Some discs will only allow you to change the audio setting from the disc menu. Refer to the manual accompanying the discs for details.
- If your language is not shown after pressing [AUDIO] several times, the disc may not have that language. However, some discs allow audio language setting on the disc menu. (Operation varies depending on the disc, so refer to the manual along with the disc.)

Camera Angles



Some DVD may contain scenes which have been shot simultaneously from various angles. You can change the camera angle if  appears on the screen. If the "ANGLE ICON" setting is "OFF" in "OTHERS" menu,  will not appear. (Refer to pages 14-16.)

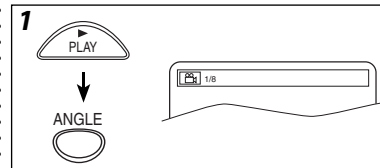

Each time you press [ANGLE], camera angle changes.

Black Level Setting



Adjust the black level to make the dark areas of the TV picture brighter.

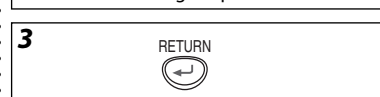
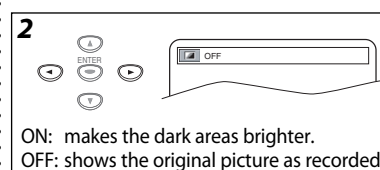
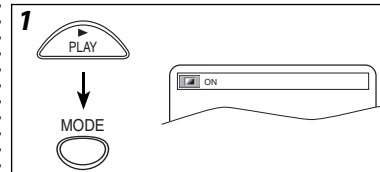

- ON: makes the dark areas brighter.
- OFF: shows the original picture as recorded.

Stereo Sound Mode



This unit allows you to select a sound mode during CD playback.

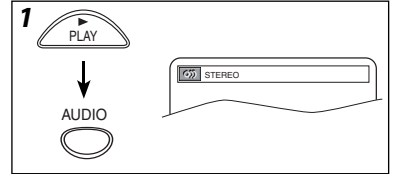

Each time you press [AUDIO], sound mode changes as example below.

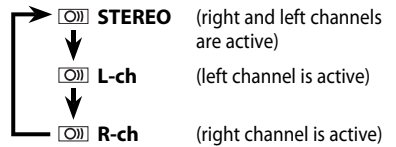

Virtual Surround



You can enjoy stereophonic virtual world on your existing 2 channel stereo system.

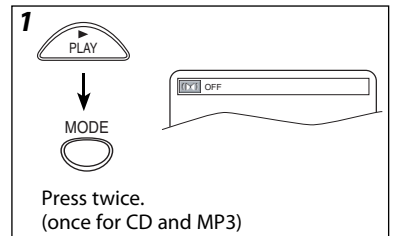

Press twice.
(once for CD and MP3)

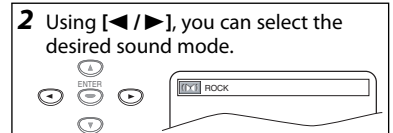

- 3D: sound mode suitable for setting stereophonic audio.
- JAZZ: sound mode suitable for jazz music
- ROCK: sound mode suitable for rock music
- POP: sound mode suitable for pop music
- CLASSIC: sound mode suitable for classic music
- OFF: no effects (original sound)

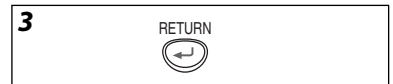

Note:

- Virtual surround is available only when the DVD player is connected to a TV or stereo using the red and white AUDIO OUT jacks on the DVD player. Also, select the "SETUP" menu to use Dolby Digital connection (COAXIAL), and setting in PCM mode.

DVD Setting

You can change the settings of the unit.

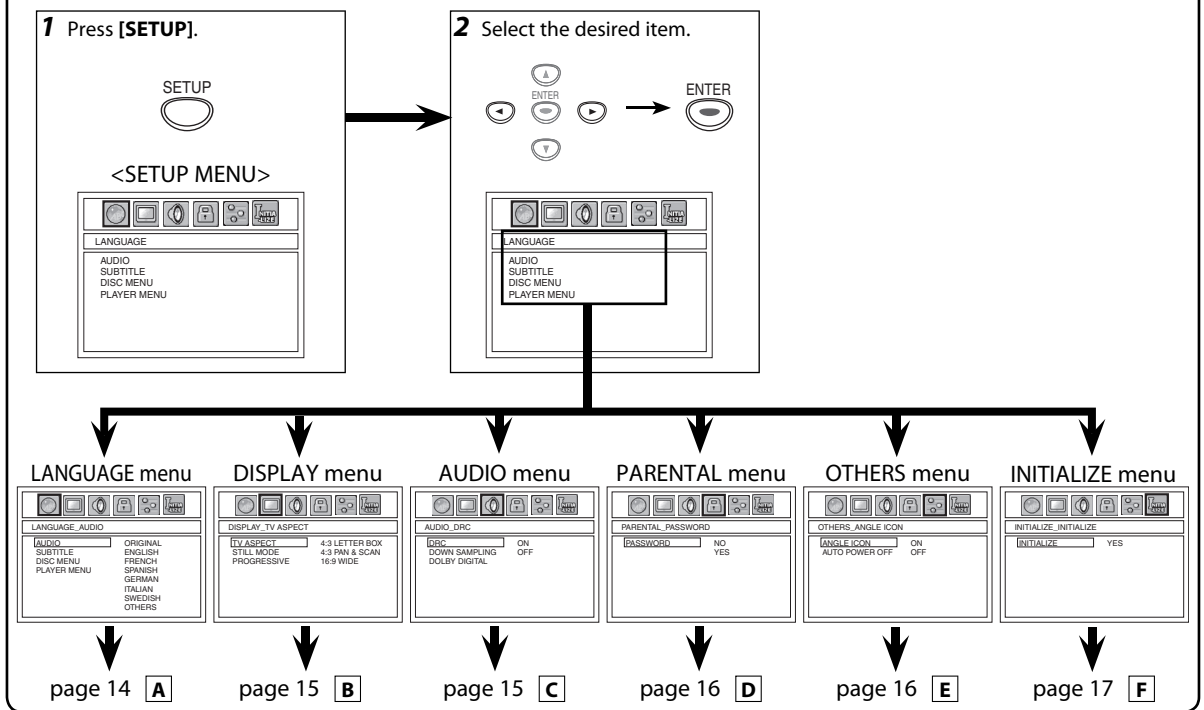

DVD FUNCTIONS

A LANGUAGE Setting

Follow steps 1 to 2 above.

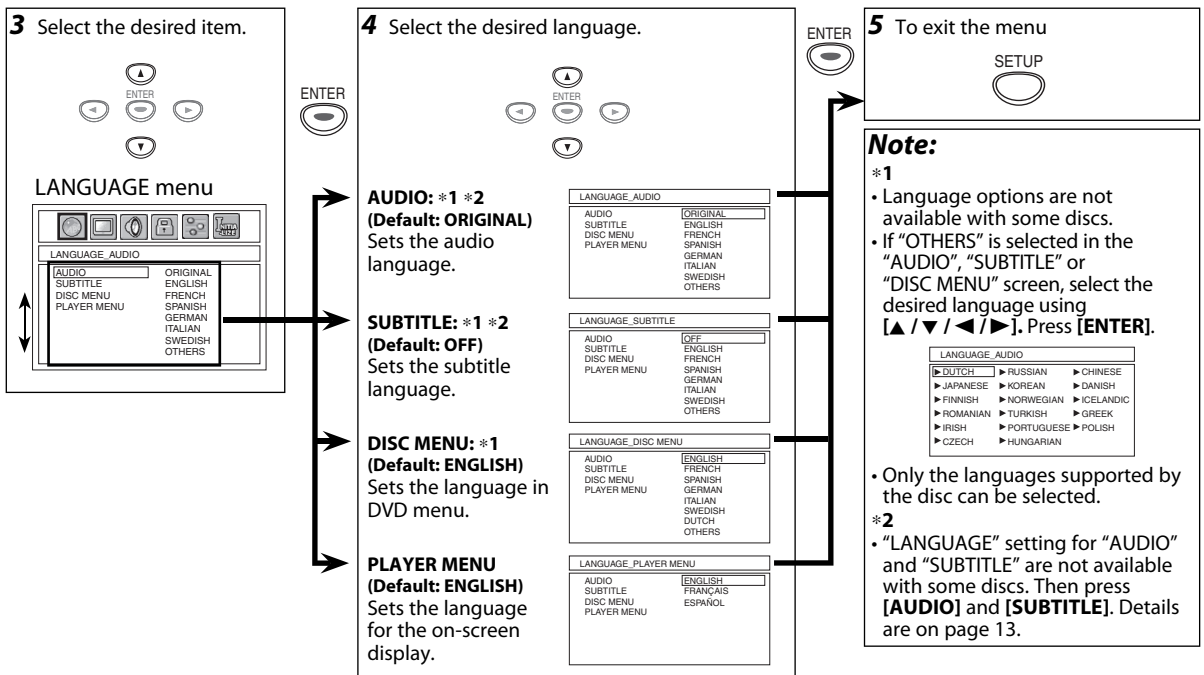

B DISPLAY Setting

You can change the display functions. Follow steps 1 to 2 on page 14.

3 Select the desired item.

TV ASPECT: (Default: 4:3 LETTER BOX)
See note on the left.

STILL MODE: (Default: AUTO)
See note on the left.

PROGRESSIVE: (Default: OFF)
See note on the right.

Note:
TV ASPECT:

- Select "4:3 LETTER BOX", so that black bars may appear on the top and bottom of the screen.
- Select "4:3 PAN & SCAN" for a full height picture with both sides adjusted.
- Select "16:9 WIDE" if a wide-screen TV is connected to this unit.

STILL MODE:

- Select "AUTO" usually.
- If you select "AUTO", it automatically selects the best resolution setting ("FRAME" or "FIELD") based on the data characteristics of the pictures. (default)
- If you select "FIELD", the picture in the still mode will be stabilized.
- If you select "FRAME", the picture in the still mode will be highly defined.
- An individual picture on TV screen is called a "frame", which consists of two separate images called as "field".
- Some pictures may be blurred if you select "AUTO" in the still mode due to their data characteristics.

Note:
PROGRESSIVE:

- You can set "PROGRESSIVE" to "OFF" in "DISPLAY" menu or press and hold [PLAY] on the front of the unit for more than 5 seconds during playback, so that the P-SCAN indicator on the front panel turns off.
- When "PROGRESSIVE" is "ON", video signals from the unit's VIDEO OUT and S-VIDEO OUT jacks will be distorted or not be output at all.

If there is no picture or you do not press any buttons for 15 seconds, "PROGRESSIVE" will switch to "OFF" and it will exit the "SETUP" menu.

5 To exit "TV ASPECT" or "STILL MODE" menu

To complete "PROGRESSIVE" setting

Note:
PROGRESSIVE:

- You can set "PROGRESSIVE" to "OFF" in "DISPLAY" menu or press and hold [PLAY] on the front of the unit for more than 5 seconds during playback, so that the P-SCAN indicator on the front panel turns off.
- When "PROGRESSIVE" is "ON", video signals from the unit's VIDEO OUT and S-VIDEO OUT jacks will be distorted or not be output at all.

C AUDIO Setting

Choose the appropriate audio settings for your device. It only affects during the playback of DVD. Follow steps 1 to 2 on page 14.

3 Select the desired item.

DRC (Dynamic Range Control): (Default: ON)
Set to "ON" to compress the range between soft and loud sounds.

DOWN SAMPLING: (Default: ON)
Set to "ON" when outputting in 48kHz.
Set to "OFF" when outputting the original sound.

DOLBY DIGITAL: (Default: BITSTREAM)
Set to "BITSTREAM" when the unit is connected to a Dolby Digital decoder.

- BITSTREAM: outputs a Dolby Digital signals.
- PCM: convert the Dolby Digital into PCM (2 channel).

5 To exit the menu

Note:
DRC:

- This function is available only on the discs which are recorded in the Dolby Digital format.

DOWN SAMPLING:

- When playing back disc with copyright protection, the sound will be down sampled at 48kHz, even if you set to "OFF".

D PARENTAL Setting

Parental control limits the disc viewing that exceed your settings. (An incorrect password will not be acceptable.) This feature prevents your children from viewing inappropriate materials.

Parental Levels

Parental level allows you to set the rating levels of your DVD. Playback will stop if the ratings exceed the levels you set. Follow steps 1 to 2 on page 14.

3 Press [ENTER], and then select "YES".



If the password has not been set yet.

PARENTAL menu

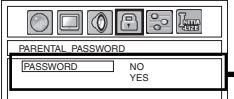

If the password has been set already, enter the current 4-digit password.

PARENTAL menu

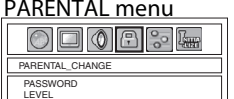

If you do not need parental lock, choose "NO". Press [ENTER].

4 Enter your desired 4-digit password.

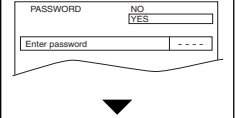
Enter a new password again.

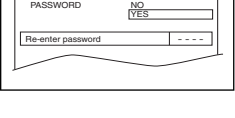

5 Select "LEVEL".

TIPS FOR LEVELS

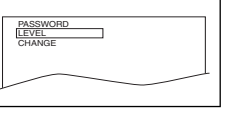
- 8 [ADULT]: DVD software of any grades (adult/general/children) can be played back.
- 7 [NC-17]: no one under 17 admitted
- 6 [R]: restricted; under 17 requires accompanying parent or adult guardian
- 5 [PGR]: parental guidance recommended
- 4 [PG13]: unsuitable for children under 13
- 3 [PG]: parental guidance suggested
- 2 [G]: general audience
- 1 [KID SAFE]: suitable for children

6 Select the desired level, and press [ENTER].

7 To exit the menu

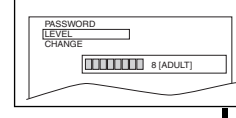

Note:

- For DVD, the resume information will be cleared if you change the parental level when the resume information is on.

To Change the Password for Parental Controls

You can change your password for parental controls. Follow steps 1 to 2 on page 14.

6 Select "CHANGE" at step 5 above.



PARENTAL menu

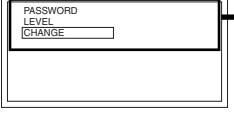

7 Enter your desired 4-digit password.

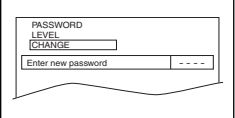
8 Enter your new 4-digit password again.

9 To exit the menu

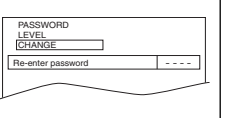

Note:

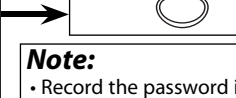
- Record the password in case you forget it.
- If you forget the password, press [4], [7], [3], [7] at step 3 above, then enter your new password. Password will be cleared and parental levels will be set to "8 [ADULT]".

E OTHERS Setting

You can change the other functions. Follow steps 1 to 2 on page 14.

3 Select the desired item.



OTHERS menu

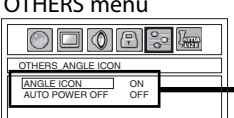

4

ANGLE ICON: (Default: ON)
Set to "ON" to display  when multiple camera angles are available during DVD playback.

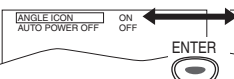

AUTO POWER OFF: (Default: ON)
Set to "ON" to turn this unit off automatically after 30 minutes of no use.

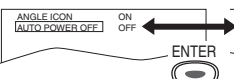

Select the desired setting.



Select the desired setting.

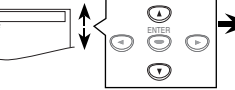

5 To exit the menu

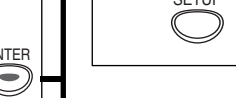

F Reset to the Default Setting (Except for PARENTAL Setting)

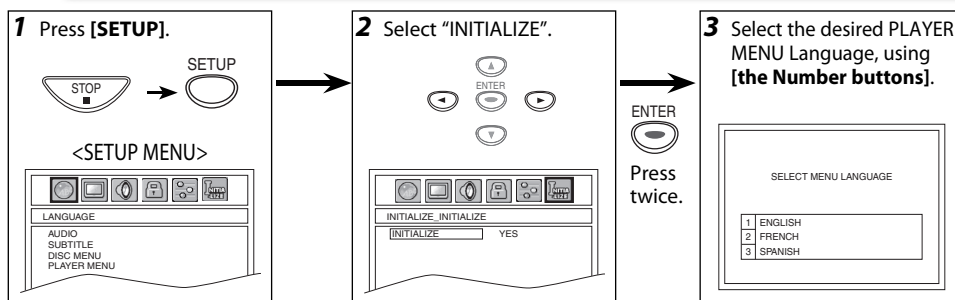

INFORMATION

Troubleshooting Guide

If the unit does not perform properly when operated as instructed in this owner's manual, refer to the following.

Problem	Corrective action
No power	<ul style="list-style-type: none"> -Check if the AC power cord is properly connected. -Unplug the outlet once, and wait for 5-10 seconds and then plug it in again.
No sound or picture	<ul style="list-style-type: none"> -Check if the TV is switched on. -Check the video connection. -Check the audio/video cable connections to the TV. (Refer to page 6.)
Distorted picture	<ul style="list-style-type: none"> -Sometimes a small amount of picture distortion may appear. This is not a malfunction. -Connect the unit directly to the TV. -Set "PROGRESSIVE" correctly in "DISPLAY" menu. Turn it on only if your TV has progressive scan and you are using the component video connections between the unit and the TV. Disable progressive scan for all other connections. (Refer to page 6.)
Completely distorted picture or black/white picture with DVD	<ul style="list-style-type: none"> -Connect this unit directly to the TV. -Make sure the disc is compatible with the unit.
No sound or distorted sound	<ul style="list-style-type: none"> -Adjust the volume. -Check that the speakers are connected correctly.
No audio at digital output	<ul style="list-style-type: none"> -Check the digital connections. -Check if the audio format of the selected audio language matches your receiver capabilities.
No DTS audio is output.	<ul style="list-style-type: none"> -This unit does not support DTS audio. This is not a malfunction.
Picture freezes momentarily during playback.	<ul style="list-style-type: none"> -Check the disc for fingerprints/dirty and clean with a soft cloth wiping from center to edge.
Disc cannot be played back.	<ul style="list-style-type: none"> -Clean the disc. -Ensure the disc is inserted in correct direction. -Check if the disc is defective by trying another disc. -Cancel the parental lock or change the control level. -Insert a correct disc that plays back on this unit. -Handle a disc with special care so that it does not have fingerprints, scratches, or dusts on its surface.
No return to start-up screen when disc is removed.	<ul style="list-style-type: none"> -Reset the unit by switching off the unit, then on again.
The unit does not respond to the remote control.	<ul style="list-style-type: none"> -Aim the remote control directly at the sensor on the front panel. -Reduce the distance to the unit. -Replace the batteries in the remote control. -Re-insert the batteries with their polarities (+/- signs) as indicated. -Tune your radio to an empty AM station so that you hear a lot of noises. Then, turn up the volume. If you hear some signal sound from the radio by pressing buttons on the remote control, the remote control is working. -Press and hold any button on remote control toward a digital camera. The remote control is working if you confirm infrared light through the digital camera.
Buttons do not work or the unit stops responding.	<ul style="list-style-type: none"> -To completely reset the unit, unplug the AC cord from the AC outlet for 5-10 seconds.
The unit does not respond to some operating commands during playback.	<ul style="list-style-type: none"> -Operations may not be permitted by the disc. Refer to the instructions of the disc.
The unit cannot read CD / DVD.	<ul style="list-style-type: none"> -Use a commonly available cleaning CD / DVD to clean the lens before sending the unit for repair.
Angle does not switch.	<ul style="list-style-type: none"> -The angle cannot be switched for DVD which do not contain multiple angles. In some cases multiple angles are only recorded for specific scenes.
Playback does not start when the title is selected.	<ul style="list-style-type: none"> -Check the "PARENTAL" setting.
The password for rating level has been forgotten.	<ul style="list-style-type: none"> -Enter the default password "4737", then your forgotten password will be cleared.

- Some functions are not available in specific modes, but this is not a malfunction. Read the description in this owner's manual for more details on correct operations.
- Playback from a desired track and random playback are not available during programmed playback.
- Some functions are prohibited on some discs.

Specifications

Output signal format:

NTSC color

Power source:

120V AC +/- 10%, 60Hz +/- 0.5%

Power consumption:

7W (standby : 0.9W)

Operating temperature:

41°F (5°C) to 104°F (40°C)

Dimensions:

W : 8 5/16" (210 mm)

H : 2" (50 mm)

D : 9 11/16" (245 mm)

Weight:

Approx 1.8lbs. (0.8 kg)

- Designs and specifications are subject to change without notice.
- If there is a discrepancy between languages, the default language will be English.

MAGNAVOX LIMITED WARRANTY

FUNAI CORP. will repair this product, free of charge in the USA in the event of defect in materials or workmanship as follows:

DURATION:

PARTS: FUNAI CORP. will provide parts to replace defective parts without charge for one (1) year from the date of original retail purchase. Certain parts are excluded from this warranty.

LABOR: FUNAI CORP. will provide the labor without charge for a period of ninety (90) days from the date of original retail purchase.

LIMITS AND EXCLUSIONS:

This warranty is extended only to the original retail purchaser. A purchase receipt or other proof of original retail purchase will be required together with the product to obtain service under this warranty.

This warranty shall not be extended to any other person or transferee.

This warranty is void and of no effect if any serial numbers on the product are altered, replaced, defaced, missing or if service was attempted by an unauthorized service center. This limited warranty does not apply to any product not purchased and used in the United States.

This product is produced for home use and this warranty only covers failures due to defects in material or workmanship which occurs during normal use. It does not cover damage which occurs in shipment, or failures which are caused by repairs, alterations or product not supplied by FUNAI CORP., or damage which results from accident, misuse, abuse, mishandling, misapplication, alteration, faulty installation, improper maintenance, commercial use such as hotel, rental or office use of this product or damage which results from fire, flood, lightning or other acts of God.

THIS WARRANTY DOES NOT COVER PACKING MATERIALS, ANY ACCESSORIES (EXCEPT REMOTE CONTROL), ANY COSMETIC PARTS, COMPLETE ASSEMBLY PARTS, DEMO OR FLOOR MODELS.

FUNAI CORP. AND ITS REPRESENTATIVES OR AGENTS SHALL IN NO EVENT BE LIABLE FOR ANY GENERAL, INDIRECT OR

CONSEQUENTIAL DAMAGES ARISING OUT OF OR OCCASIONED BY THE USE OF OR THE INABILITY TO USE THIS PRODUCT. THIS WARRANTY IS MADE IN LIEU OF ALL OTHER WARRANTIES, EXPRESS OR IMPLIED, AND OF ALL OTHER LIABILITIES ON THE PART OF FUNAI, ALL OTHER WARRANTIES INCLUDING THE WARRANTY OF MERCHANTABILITY, AND FITNESS FOR A PARTICULAR PURPOSE, ARE HEREBY DISCLAIMED BY FUNAI AND ITS REPRESENTATIVES IN THE UNITED STATES. ALL WARRANTY INSPECTIONS AND REPAIRS MUST BE PERFORMED BY AN AUTHORIZED SERVICE CENTER. THIS WARRANTY IS VALID WHEN THE UNIT IS CARRIED-IN TO AN AUTHORIZED SERVICE CENTER.

IMPORTANT:

THIS LIMITED WARRANTY GIVES YOU SPECIFIC LEGAL RIGHTS. YOU MAY HAVE OTHER RIGHTS THAT VARY FROM STATE TO STATE. IF, AT ANY TIME DURING THE WARRANTY PERIOD, YOU ARE UNABLE TO OBTAIN SATISFACTION WITH THE REPAIR OF THIS PRODUCT, PLEASE CONTACT FUNAI CORP.

ATTENTION:

FUNAI CORP. RESERVES THE RIGHT TO MODIFY ANY DESIGN OF THIS PRODUCT WITHOUT PRIOR NOTICE.

WARRANTY STATEMENT REGARDING NON AUTHORIZED REPAIRS:

To obtain warranty service, you must take the product, or deliver the product freight prepaid, in either its original packaging or packaging affording an equal degree of protection, to any AUTHORIZED SERVICE CENTER. FUNAI CORP. will not reimburse you for any service done by unauthorized service providers without prior written approval.

To locate your nearest AUTHORIZED SERVICE CENTER or for general service inquiries, please contact us at:

FUNAI SERVICE CORPORATION

Tel : 1-800-605-8610

<http://www.magnavox.com/support>

2200 Spiegel Drive, Groveport, OH 43125

1 Conexiones

Si su televisor tiene entradas de AUDIO/VIDEO vea la sección "Connection to a TV" en la página 6 en el manual de manejo. En caso contrario, vea la sección "Connecting to RF Modulator (Not Supplied)" en la página del frente en el manual de manejo.

2 Instalación de las pilas en el control remoto



* Pilas no provistas.

3 Para cambiar el idioma en la pantalla

1 Confirme que ha seleccionado "LANGUAGE".



2 Seleccione "PLAYER MENU".



3 Seleccione el idioma deseado para las indicaciones en la pantalla.



4 Para salir del menú

4 Reproducción

Antes.
¡Encienda el televisor, amplificador y otros equipos conectados a esta unidad. Asegúrese que el televisor y el sintonizador de audio (no provisto) están en el canal correcto.

1 Para abrir o cerrar la bandeja del disco

2 Ponga un disco con la etiqueta hacia arriba.

3 Para empezar la reproducción

4 Para parar la reproducción

5 Control remoto

Botón (Orden alfabético)	Disco	DVD	CD / MP3
1 2 3			• Para seleccionar directamente el capítulo o título.
4 5 6			• Para seleccionar directamente la canción. (CD)
7 8 9			• Para seleccionar directamente el grupo / canción. (MP3)
0			
ENTER		• Para mover el cursor y determinar la posición.	• Para mover el cursor y determinar la posición.
A-B		• Para repetir entre su punto A y B seleccionado.	• Para repetir entre su punto A y B seleccionado.
ANGLE		• Para seleccionar los ángulos de la cámara en un disco.	—
AUDIO		• Para seleccionar idiomas de audio en un disco.	• Para seleccionar "ESTEREO", "L-ch" o "R-ch". (CD)
CLEAR		• Para eliminar el N° de estado en la entrada de programa. • Para borrar los números mal entrados. • Para borrar el punto para la repetición A-B.	• Para eliminar el N° de estado en la entrada de programa. • Para borrar los números mal entrados. • Para borrar el punto para la repetición A-B.
DISPLAY		• Para mostrar el modo de disco actual.	• Para mostrar el modo de disco actual.
REV FWD		• Para buscar en avance/retroceso por un disco. • Para empezar la reproducción en avance lento durante el modo de pausa.	• Para buscar en avance/retroceso por un disco.
MENU		• Para llamar el menú en un disco.	—
MODE		• Para disponer el orden de reproducción o la reproducción aleatoria. • Para activar/desactivar el nivel del negro. • Para activar/desactivar el ambiental virtual.	• Para disponer el orden de reproducción o la reproducción aleatoria. • Para activar/desactivar el ambiental virtual.
OPEN/CLOSE		• Para abrir o cerrar la bandeja del disco. • Para encender la unidad.	• Para abrir o cerrar la bandeja del disco. • Para encender la unidad.
PAUSE		• Para hacer una pausa en la reproducción. • Para avanzar la reproducción un cuadro cada vez.	• Para hacer una pausa en la reproducción del disco.
PLAY		• Para empezar la reproducción del disco. • Para encender la unidad.	• Para empezar la reproducción del disco. • Para encender la unidad.
REPEAT		• Para reproducir repetidamente un capítulo o título.	• Para reproducir repetidamente una canción o disco. (CD) • Para reproducir repetidamente una canción, grupo o disco. (MP3)
RETURN		• Para volver a la operación anterior en el menú.	• Para volver a la operación anterior en el menú.
SEARCH		• Para buscar un capítulo, título o tiempo.	• Para buscar una canción. • Para buscar el tiempo. (CD) • Para buscar los grupos. (MP3)
SETUP		• Para llamar el menú de ajustes de DVD.	• Para llamar el menú de ajustes de DVD.
SKIP		• Para saltar capítulos o título.	• Para saltar canciones. (CD) • Para saltar los grupos o canciones. (MP3)
STANDBY-ON		• Para encender o para pasar la unidad al modo de espera. (Para apagar completamente la unidad, debe desconectar el cable de alimentación de CA.)	• Para encender o para pasar la unidad al modo de espera. (Para apagar completamente la unidad, debe desconectar el cable de alimentación de CA.)
STOP		• Para parar la reproducción.	• Para parar la reproducción.
SUBTITLE		• Para seleccionar subtítulos en un disco.	—
TOP MENU		• Para llamar el menú inicial en un disco.	—
ZOOM		• Para ampliar la imagen de vídeo en DVD. (2x / 3x / 4x / 1/2x)	—

Quick Use Guide

1 Connections

If your TV has AUDIO/VIDEO input jacks, see the section "Connection to a TV" on page 6 of the owner's manual. If not, see the section "Connecting to RF Modulator (Not Supplied)" on the front page of the owner's manual.

2 Installing the Batteries for the Remote Control

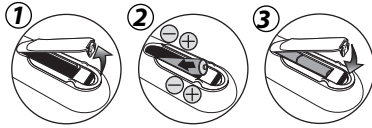

* Batteries not supplied.

3 To Change the On-Screen Language

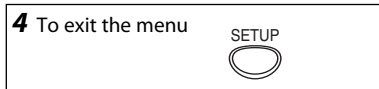
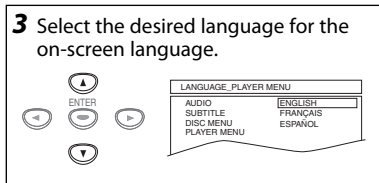
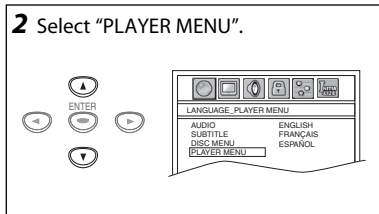
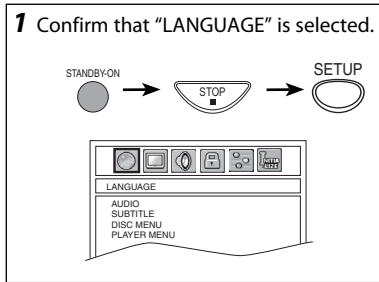

4 Playback

Before:

Turn on the TV, amplifier and any other device which are connected to this unit. Make sure the TV and audio receiver (not supplied) are set to the correct channel.

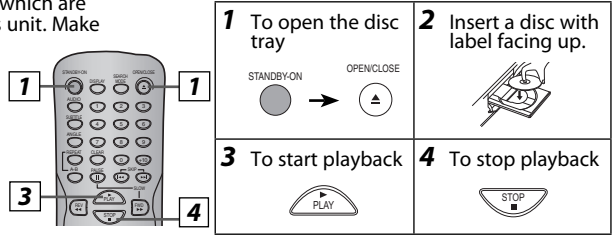

1 To open the disc tray STANDBY-ON → OPEN/CLOSE	2 Insert a disc with label facing up.
3 To start playback PLAY	4 To stop playback STOP

5 Remote Control

Button (Alphabetical order)	Media 	
1 2 3 4 5 6 7 8 9 0	• To select chapter or title directly.	• To select track directly. (CD) • To select folder/file directly. (MP3)
ENTER	• To move the cursor and determine its position.	• To move the cursor and determine its position.
A-B	• To repeat between your chosen point of A and B.	• To repeat between your chosen point of A and B.
ANGLE	• To select camera angles on a disc.	—
AUDIO	• To select audio language on a disc.	• To select "STEREO", "L-ch" or "R-ch". (CD)
CLEAR	• To remove status number in program input. • To clear the numbers entered incorrectly. • To cancel the point for A-B repeat.	• To remove status number in program input. • To clear the numbers entered incorrectly. • To cancel the point for A-B repeat.
DISPLAY	• To display the current disc mode.	• To display the current disc mode.
REV FWD	• To search forward/backward through a disc. • To begin slow forward playback in the pause mode.	• To search forward/backward through a disc.
MENU	• To call up the menu on a disc.	—
MODE	• To arrange the playing order or play randomly. • To set black level on/off. • To set virtual surround on/off.	• To arrange the playing order or play randomly. • To set virtual surround on/off.
OPEN/CLOSE	• To open or close the disc tray. • To turn on the unit.	• To open or close the disc tray. • To turn on the unit.
PAUSE	• To pause disc playback. • To advance playback one frame at a time.	• To pause disc playback.
PLAY	• To begin disc playback. • To turn on the unit.	• To begin disc playback. • To turn on the unit.
REPEAT	• To play back a chapter or title repeatedly.	• To play a back track or disc repeatedly. (CD) • To play back a file, folder or disc repeatedly. (MP3)
RETURN	• To return to the previous operation in menu.	• To return to the previous operation in menu.
SEARCH MODE	• To search chapter, title or time.	• To search tracks. • To search time. (CD) • To search folders. (MP3)
SETUP	• To call up the setup menu.	• To call up the setup menu.
SKIP	• To skip chapters or titles.	• To skip tracks. (CD) • To skip folders or files. (MP3)
STANDBY-ON	• To turn the unit on or to turn the unit into the standby mode. (To completely turn off the unit, you must unplug the AC power cord.)	• To turn the unit on or to turn the unit into the standby mode. (To completely turn off the unit, you must unplug the AC power cord.)
STOP	• To stop playback.	• To stop playback.
SUBTITLE	• To select subtitles on a disc.	—
TOP MENU	• To call up the top menu on a disc.	—
ZOOM	• To magnify part of a picture. (2x / 3x / 4x / 1/2x)	—

cut here



Free Manuals Download Website

<http://myh66.com>

<http://usermanuals.us>

<http://www.somanuals.com>

<http://www.4manuals.cc>

<http://www.manual-lib.com>

<http://www.404manual.com>

<http://www.luxmanual.com>

<http://aubethermostatmanual.com>

Golf course search by state

<http://golfingnear.com>

Email search by domain

<http://emailbydomain.com>

Auto manuals search

<http://auto.somanuals.com>

TV manuals search

<http://tv.somanuals.com>