

MDV530VR

Digital Video Disc Player & Video Cassette Recorder



NEED HELP? CALL US!

MAGNAVOX REPRESENTATIVES ARE READY TO HELP YOU WITH ANY QUESTIONS ABOUT YOUR NEW PRODUCT. WE CAN GUIDE YOU THROUGH CONNECTIONS, FIRST-TIME SETUP, AND ANY OF THE FEATURES.

WE WANT YOU TO START ENJOYING YOUR NEW PRODUCT RIGHT AWAY.

CALL US BEFORE YOU CONSIDER RETURNING THE PRODUCT.

1-800-705-2000

OR VISIT US ON THE WEB AT WWW.MAGNAVOX.COM



IMPORTANT!

RETURN YOUR WARRANTY REGISTRATION CARD WITHIN 10 DAYS.

SEE WHY INSIDE.

Return your Warranty Registration card today to ensure you receive all the benefits you're entitled to.

Once your MAGNAVOX purchase is registered, you're eligible to receive all the privileges of owning a MAGNAVOX product. So complete and return the Warranty Registration Card enclosed with your purchase at once. And take advantage of these important benefits.

Warranty Verification

Registering your product within 10 days confirms your right to maximum protection under the terms and conditions of your MAGNAVOX warranty.

Owner Confirmation

Your completed Warranty Registration Card serves as verification of ownership in the event of product theft or loss.

Model Registration

Returning your Warranty Registration Card right away guarantees you'll receive all the information and special offers which you qualify for as the owner of your model.

Congratulations on your purchase, and welcome to the "family!"



Dear MAGNAVOX product owner:

Thank you for your confidence in MAGNAVOX. You've selected one of the best-built, best-backed products available today. And we'll do everything in our power to keep you happy with your purchase for many years to come.

As a member of the MAGNAVOX "family," you're entitled to protection by one of the most comprehensive warranties and outstanding service networks in the industry.

What's more, your purchase guarantees you'll receive all the information and special offers for which you qualify, plus easy access to accessories from our convenient home shopping network.

And most importantly you can count on our uncompromising commitment to your total satisfaction.

All of this is our way of saying welcome-and thanks for investing in a MAGNAVOX product.

P.S. Remember, to get the most from your MAGNAVOX product, you must return your Warranty Registration Card within 10 days. So please mail it to us right now!

Know these

safety symbols



⚡ This "bolt of lightning" indicates uninsulated material within your unit may cause an electrical shock. For the safety of everyone in your household, please do not remove product covering.

! The "exclamation point" calls attention to features for which you should read the enclosed literature closely to prevent operating and maintenance problems.

WARNING: TO PREVENT FIRE OR SHOCK HAZARD, DO NOT EXPOSE THIS EQUIPMENT TO RAIN OR MOISTURE.

CAUTION: To prevent electric shock, match wide blade of plug to wide slot, fully insert.

ATTENTION: Pour éviter les choc électriques, introduire la lame la plus large de la fiche dans la borne correspondante de la prise et pousser jusqu'au fond.

For Customer Use

Enter below the Serial No. which is located on the rear of the cabinet. Retain this information for future reference.

Model No. _____
Serial No. _____

Visit our World Wide Web Site at <http://www.magnavox.com>

Safety and General Information 3

Safety Precautions

Warning: To prevent fire or shock hazard, do not expose this equipment to rain or moisture.

Federal Communications Commission (FCC) Warning: Any unauthorized changes or modifications to this equipment void the user's authority to operate it.

Department of Health and Human Services (DHHS) Certification: Complies with 21 Center for Radiation (CFR) chapter 1 subchapter J applicable at time of manufacture.

Laser Safety: This unit employs a laser. Only a qualified service person should remove the cover or attempt to service this device, due to possible eye injury.

CAUTION: USE OF CONTROLS OR ADJUSTMENTS OR PERFORMANCE OF PROCEDURES OTHER THAN THOSE SPECIFIED HEREIN MAY RESULT IN HAZARDOUS RADIATION EXPOSURE.

CAUTION: VISIBLE AND INVISIBLE LASER RADIATION WHEN OPEN AND INTER-LOCK DEFEATED. DO NOT STARE INTO BEAM. THE BEAM IS LOCATED INSIDE, NEAR THE DECK MECHANISM.

Special Information for Canadian Users: This Class B digital apparatus complies with Canadian ICES-003. Cet appareil numérique de la classe B est conforme à la norme NMB-003 du Canada.

Radio/TV Interference: This equipment has been tested and found to comply with the limits for a Class B digital device, pursuant to Part 15 of the FCC Rules. These limits are designed to provide reasonable protection against harmful interference in a residential installation. This equipment generates, uses, and can radiate radio frequency energy and, if not installed and used in accordance with the instructions, may cause harmful interference to radio communications. However, there is no guarantee that interference will not occur in a particular installation. If this equipment does cause harmful interference to radio or television reception, which can be determined by turning the equipment off and on, the user is encouraged to try to correct the interference by one or more of the following measures:

- 1) Reorient or relocate the receiving antenna.
- 2) Increase the separation between the equipment and the receiver.
- 3) Connect the equipment into an outlet on a circuit different from that to which the receiver is connected.
- 4) Consult the dealer or an experienced radio/TV technician for help.

Copyright Protection: Unauthorized copying, broadcasting, public performance and lending of Discs are prohibited. This product incorporates copyright protection technology that is protected by method claims of certain U.S. patents and other intellectual property rights owned by Macrovision Corporation and other rights owners. Use of this copyright protection technology must be authorized by Macrovision Corporation and is intended for home and other limited viewing uses only unless otherwise authorized by Macrovision Corporation. Reverse engineering or disassembly is prohibited.

Note to the Cable TV System Installer: This reminder is provided to call the Cable TV system installer's attention to Article 820-40 of the National Electrical Code, which provides guidelines for proper grounding – in particular, specifying that the cable ground shall be connected to the grounding system of the building, as close to the point of cable entry as possible.

Declaration of Conformity

Model Number: MDV530VR
Trade Name: Magnavox
Responsible Party: Philips Consumer Electronics
P.O. Box 14810
Knoxville, TN 37914-1810
(865) 521-4316

Manufactured under license from Dolby Laboratories. "Dolby" and the double-D symbol are trademarks of Dolby Laboratories.
Copyright 2003 Magnavox. All rights reserved.

4 Table of Contents

General Information

Safety and General Information	.3
Table of Contents	.4
Introduction	.5
Playable Discs and Video Cassettes	.6

Initial DVD/VCR Setup

Hookups	.7-15
Remote Control Setup	.16
First-time DVD/VCR Setup	.17

Basic Playback

Video Cassette Playback	.18
Disc Playback	.19

Basic DVD/VCR Controls

Display Panel (DVD)	.20
Display Panel (VCR)	.21
Front Panel	.22
Rear Panel	.23
Remote Control	.24-25

Additional VCR Setup

Channel Setup	.26-27
Clock (VCR)	.28-29
Language (VCR)	.30
VCR Status Displays	.31

VCR Recording Options

Videotape Recording	.32
Recording One Channel/Watching Another	.33
One-Touch Recording	.34
Rerecording (Tape Duplication)	.35
Timer Recording	.36-38
DVD to Videotape Duplication	.39

Video Cassette Playing Options

Repeat Play	.40
Tape Counter	.41
Time Search, Index Search	.42
Special Effects Playback	.43
Automatic Operation Features	.44

Additional VCR Features

Multi-Channel Television Sound	.45-46
Hi-Fi Stereo	.47

Disc Playback Features

DVD Disc Menus	.48
Fast Forward/Reverse Search	.49
Title/Chapter Playback, Specific Time Playback	.50
Track Playback	.51
Paused and Step-by-Step Playback, Resume	.52
Repeat, A-B Repeat	.53
Markers	.54
Subtitles, Camera Angles	.55
Parental Controls Password	.56
Parental Levels	.57
Audio Language, Stereo Sound Mode	.58
DVD Slow Motion, Zoom	.59
Programmed Playback	.60
Random Playback	.61
MP3/JPEG Playback	.62
MP3/JPEG Displays	.63

DVD Player Setup Options

Display	.64-65
Language	.66-67
Audio	.68
On-Screen Displays	.69
Black Level, Virtual Surround	.70

Information You May Need

Care and Maintenance	.71
Glossary	.72
Specifications	.73
Helpful Hints	.74-77
Limited Warranty	.78-79
Information Index	.80

Welcome!

This DVD/VCR combines a Digital Video Disc (DVD) Player and a Hi-Fi Video Cassette Recorder (VCR) into one unit, letting you play DVDs, Audio Compact Discs (Audio CDs), and Video Cassettes on one piece of equipment.

Read this owner's manual carefully to learn how to use the features listed below.

VCR Features

- Automatic Head Cleaner
- Channel Setup
- English, French, and Spanish menus and displays
- Multi-Channel TV Sound
- 19 Micron head
- Recording: One-Touch and Timer
- Repeat Play
- Searching: Time, Index, Forward, and Reverse
- Slow Motion
- Still Picture
- Tape Counter
- Tracking Adjustment

Disc Features

- Audio Language choices*
- Bit Rate display
- Camera Angle *
- Dolby Digital Sound*
- DVD to Videotape Duplication
- Dynamic Range Control
- Fast/Paused/Slow/Step-by-Step Playback
- Markers
- Parental Controls*
- Program Playback
- Random Playback
- Repeat, Repeat A-B
- Screen Saver
- Search (Title/Chapter, Time, Track)
- Subtitles*
- Virtual Surround
- Zoom
- * *If available on the DVD*

Package Contents

The following items are provided with your new DVD/VCR.

- Remote Control and two AA batteries
- One black RF coaxial cable, 75 ohm
- One set of Audio (red and white tips) and Video (yellow tips) cables

DVD Disc Menus...

Some explanations in this manual describe DVD Disc menus. DVD manufacturers set the menus, which vary among DVDs. Not all DVDs have menus. If the DVD has a menu, access it by pressing DVD, then DISC/MENU on the remote control.

Details are on page 48.

DVD Player Setup Menu...

Some instructions explain how to use the DVD Player's Setup menu to set up features of the DVD Player or a DVD. Access the DVD Player menu by pressing SETUP on the remote control when playback is stopped. Even if a feature is set in the DVD Player's menu, it may not be available if the current DVD does not include that feature.

Available Disc Features...



All features described in this manual are not available on every Disc. If the feature is not available on the Disc, you cannot use the DVD/VCR to make it available. An "X" will appear in the top right corner of the TV screen if you try to access a feature that is not currently available.

6 Playable Discs and Video Cassettes

Playable Discs

The DVD Player will play Digital Video Discs (DVDs); Audio Compact Discs (CDs); finalized Digital Video Discs Rewritable (DVD+RW); and finalized Compact Discs Rewritable (CD-RW) and Compact Discs Recordable (CD-R).

To play a DVD, make sure it meets the requirements for Region Codes and Color Systems as described below. Discs that have the following logos will play on the DVD Player. Other Disc types are not guaranteed to play in the DVD/VCR.



DVD



Audio CD



CD-RW/CD-R



DVD+RW

Region Codes

This DVD/VCR has a Region One (1) DVD Player. DVDs must be labeled for ALL regions or for Region 1 in order to play on the DVD Player. You cannot play DVDs that are labeled for other regions. Look for the symbols below on your DVDs. If these region symbols do not appear on your DVD, you cannot play the DVD in this DVD Player.



The number inside the globe refers to a region of the world. Region 1 represents the United States, Canada, upper regions of North America, Bermuda, the U.S. Virgin Islands, and small regions near Australia.

A DVD labelled for a specific region can only play on DVD Players with the same region code.

Color Systems

DVDs are recorded in different color systems throughout the world. The most common color systems are NTSC (which is used primarily in the United States and North America), PAL, and SECAM.

This DVD Player uses NTSC, so DVDs you play must be recorded in the NTSC system. You cannot play DVDs recorded in other formats. The color system of the DVD may be listed on the DVD or on the Disc case.

Playable Video Cassettes

The VCR of this DVD/VCR has a High Quality (HQ) system and is compatible with existing Video Home System (VHS) equipment. Use only video cassettes that have the **VHS** mark. The use of other tapes may result in poor picture quality and excessive deposits on the video heads, which may not be covered by the warranty if damage occurs.

The VCR also has a 19 micron head, which provides a better picture when you view tapes recorded in slow speed (SLP).

Determining the best possible connection...

Your hookup will be determined primarily by your existing equipment, especially your TV. However, the following guidelines describe which options have the best picture (video) and sound (audio) quality. You will not use all the jacks on the DVD/VCR.

If your TV only has an RF-style jack, usually labelled Antenna In, RF In, or 75 ohm, use the ANT-OUT jack of the DVD/VCR to connect to the TV. This hookup provides both audio and video in a single cable. Set your TV to channel 3 or 4 - the output channel of the DVD/VCR. This connection allows you to use both the DVD and VCR features. Details are on page eight.

- ★★★★ If your television has Component Video In jacks (which also could be labelled Y Cr Cb, Y Pr Pb, or YUV and may be green, blue, and red), use the Component Video jacks (Y CR CB) for the best picture quality.
If you use only this video connection, only the DVD picture will be available. To see DVD features on the TV, set the TV to its Component Video In channel. *Details are on page 12.*
- ★★★ If your TV has an S-Video In jack (which also may be labelled Y/C or S-VHS), use the S-Video jack for excellent picture quality. If you use only this video connection, only the DVD picture will be available. To see DVD features on the TV, set the TV to its S-Video In channel. *Details are on page 13.*
- ★★ If your TV has a single yellow Video In jack (which also may be labelled CVBS, Composite, or baseband), use the yellow Video jack for good picture quality. This connection provides a picture for both the DVD Player and the VCR. To see DVD or VCR features on the TV, set the TV to its Video In channel. *Details are on page 11.*
- ★★★ If you have a Stereo with a Coaxial Digital Audio In jack, this provides the clearest sound for the DVD Player. Connect the DVD/VCR's COAXIAL DIGITAL AUDIO OUT jack to your Stereo for the best sound quality. If you use only this audio connection, only Disc sound (no VCR) will be available. *Details are on page 15.*
- ★★★★ If digital audio connections are not possible, connect the DVD/VCR's red and white DVD/VCR AUDIO OUT jacks to the Audio In jacks of your Stereo or TV. This connection provides sound for both the DVD Player and the VCR. *Details are on pages 11-14.*

Before you begin...

- Refer to the manuals of your TV, Cable Box, Stereo, or other devices as necessary. Note the style of jacks and connectors on the other equipment. Determine how to choose different Audio and Video In channels on your other equipment so you can see and hear the DVD/VCR material playing on the TV, Stereo, etc.
- Disconnect all equipment from the power outlets. Connect the equipment to the power outlets only after you have finished hooking up everything. Never make or change connections with equipment connected to the power outlet.

Remember...

- Set the TV to the correct Video In channel. Such channels may be called AUX or AUXILIARY IN, AUDIO/VIDEO or A/V IN, EXT1 or External In, etc. These channels often are located near channel 00. See your TV owner's manual for details. If you do not see the DVD or VCR playback on the TV, go to the lowest TV channel (01 or 02) and change channels downward until you see the DVD or VCR picture on the TV. Or, if your TV has only a single Antenna In jack and you are using the RF coaxial cable (as described on page eight), set the TV to channel 3 or 4.
To help you find the right Audio/Video In channel, turn on the DVD/VCR. Press DVD to put the DVD/VCR in DVD mode. With no Disc in the Player, a large DVD Video logo will appear on the TV screen when you get the TV on the correct Audio/Video In channel or channel 3 or 4.
- Set the Stereo to the correct channel or "source" mode.
- Depending on your connection, you may need to purchase additional cables or adaptors.
- **To use the VCR features, you must include a connection with the supplied yellow video cable and red/white audio cables or with the supplied RF coaxial cable.**

Once you determine the best option, find your choice on pages 8-15. Follow the specific steps for the hookup you choose. After hooking up the DVD/VCR, go to page 17 to complete the first-time setup.

8 Hookups (cont'd)

DVD/VCR to TV only

Simplest connection using only the supplied black RF coaxial cable
This connection will let you use the features of both the VCR and the DVD Player.

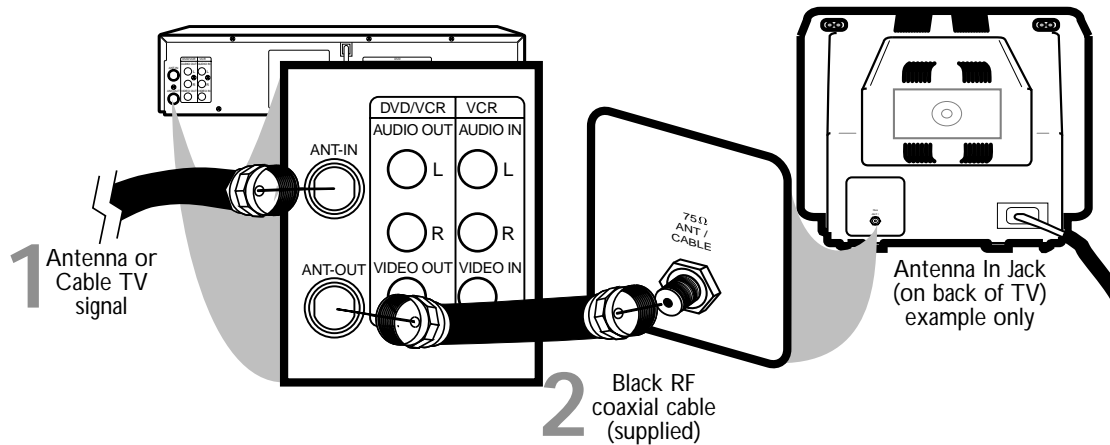

- 1 Disconnect the antenna or Cable TV signal from your TV and connect it to the ANT-IN (Antenna In) Jack of your DVD/VCR.
- 2 Connect the supplied black RF coaxial cable to the ANT-OUT (Antenna Out) Jack on the back of the DVD/VCR and to the ANTENNA IN Jack on the TV. The ANTENNA IN jack on the TV may be labelled TV IN, RF IN, 75Ω (ohm), or ANT. IN. See your TV owner's manual for assistance.
- 3 Plug in the power cords of the TV and the DVD/VCR.
- 4 Set your TV to channel 3 or 4. The DVD/VCR's output channel is 3 when you purchase it. So, set your TV to channel 3 when the DVD/VCR is new. If you cannot use channel 3 at your TV, you can change the DVD/VCR's output channel to channel 4. To do so, press the VCR button to put the DVD/VCR in VCR mode. The green VCR light will be on the front of the DVD/VCR. Insert a videotape and press PLAY ► to start playback. **During playback, press and hold the (VCR) PLAY ► button on the front of the DVD/VCR for three to five seconds.** Each time you do this, the DVD/VCR's output channel switches between 3 and 4. Change your TV to channel 3 or 4 accordingly. (You cannot change the DVD/VCR's output channel while adjusting tracking manually. Press STOP ■ to stop play and cancel manual tracking, then press PLAY ► to resume play and change the output channel.) There is not a channel 3/4 switch on the DVD/VCR (as customary with most VCRs).
- 5 You are ready to turn on the DVD/VCR. Go to page 17 before turning on the DVD/VCR.

DVD/VCR to Cable Box or Satellite Receiver and TV

Using only basic RF coaxial cables

This connection will let you use the features of both the VCR and the DVD Player.

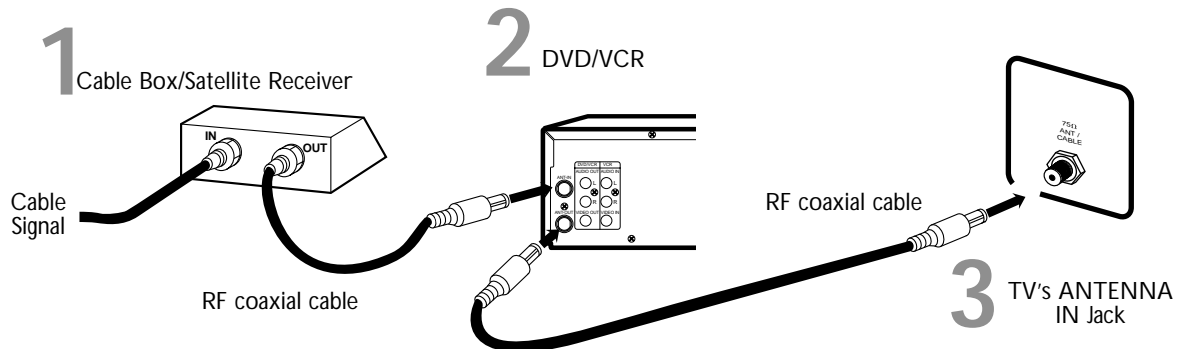

Connections

- 1** Connect a Cable TV or Satellite signal to the IN jack on the Cable Box/Satellite Receiver.
- 2** Use an RF coaxial cable (as the one supplied) to connect the OUT Jack on the Cable Box/Satellite Receiver to the ANT-IN (Antenna In) jack on the DVD/VCR.
- 3** Use a second RF coaxial cable to connect the ANT-OUT (Antenna Out) jack on the DVD/VCR to the TV's Antenna In jack.

Remember...

There are two ways to connect your Cable Box/Satellite Receiver to the DVD/VCR. With the connection on this page:

- Select TV channels at the Cable Box/Satellite Receiver, not the DVD/VCR. To record or view TV channels, follow these steps:
 - 1) Press VCR to put the DVD/VCR in VCR mode. The green VCR light will appear on the front of the DVD/VCR.
 - 2) Press SKIP ►►/CH▲ or SKIP ◄◄/CH▼ to set the DVD/VCR to the Cable Box/Satellite Receiver output channel (03 or 04).
 - 3) Set the TV to the DVD/VCR's output channel (03 or 04). The DVD/VCR's output channel is channel 3 when the DVD/VCR is new. To change it from 3 to 4, press and hold the (VCR) PLAY ► button on the DVD/VCR for 3-5 seconds during tape playback. *For more details, see step 4 on page eight.*
 - 4) Select the channel you want to view/record at the Cable Box/Satellite Receiver.
- You may not view a channel other than the one you are recording.
- You can only program a timer recording for one channel at a time. Set your Cable Box/Satellite Receiver to the channel you want to record. When you enter the channel you want to record in a timer recording, select channel 03 or 04 (the Cable Box/Satellite Receiver output channel). (This is step 7 on page 38.) Leave the Cable Box/Satellite Receiver on for a timer recording.

Helpful Hint

- If your Cable Box or Satellite Receiver has Audio and Video Out jacks, use audio and video cables to connect them to the VCR AUDIO IN and VIDEO IN jacks on the rear of the DVD/VCR. You will not need the RF coaxial cable connection between the Cable Box/Satellite Receiver and the DVD/VCR as described at step 2.

10 Hookups (cont'd)

DVD/VCR to Cable Box or Satellite Receiver and TV

Using only basic RF coaxial cables

This connection will let you use the features of both the VCR and the DVD Player.

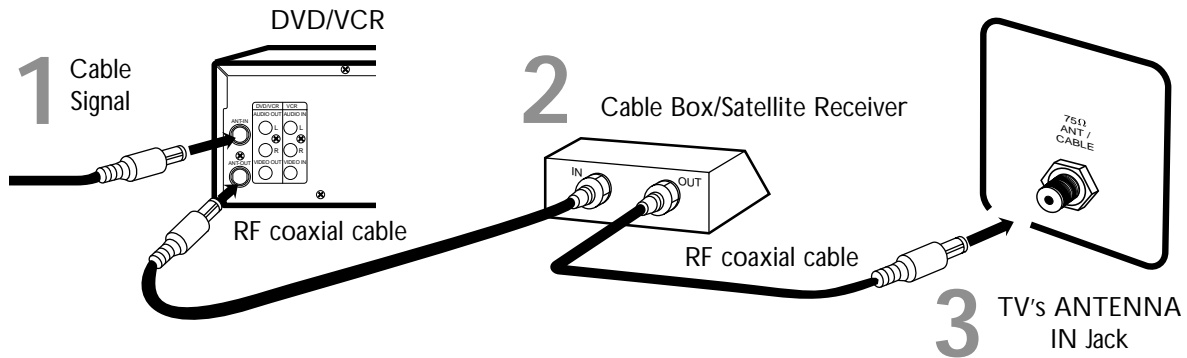

Connections

- 1 Connect a Cable TV or Satellite signal to the DVD/VCR's ANT-IN (Antenna In) jack.
- 2 Use an RF coaxial cable (as the one supplied) to connect the ANT-OUT (Antenna Out) jack on the DVD/VCR to the IN jack on the Cable Box/Satellite Receiver.
- 3 Use a second RF coaxial cable to connect the OUT jack on the Cable Box/Satellite Receiver to the ANTENNA IN jack on the TV.

Remember...

There are two ways to connect your Cable Box/Satellite Receiver to the DVD/VCR. With the connection on this page:

- You may watch one channel while recording another. Follow these steps:
 - 1) Put the Cable Box/Satellite Receiver on the same channel as the DVD/VCR's output channel (03 or 04). The DVD/VCR's output channel is channel 3 when the DVD/VCR is new. To alternate it between 3 and 4, press and hold the (VCR) PLAY ► button on the front of the DVD/VCR for 3-5 seconds during tape playback. For more details, see step 4 on page eight. Set the TV to the Cable Box/Satellite Receiver output channel (03 or 04).
 - 2) Press VCR to put the DVD/VCR in VCR mode. The green VCR light will appear on the front of the DVD/VCR.
 - 3) Press VCR/TV on the remote to choose VCR position.
 - 4) Press SKIP ►►/CH▲ or SKIP ◄◄/CH▼ to select the channel you want to record at the DVD/VCR. Press REC or RECORD to start the recording.
 - 5) Press VCR/TV on the remote once to put the DVD/VCR in TV position.
 - 6) Select the channel you want to watch at the Cable Box/Satellite Receiver.
- When you play a tape or Disc, make sure the Cable Box/Satellite Receiver is set to the DVD/VCR's output channel (03 or 04). Set the TV to the Cable Box/Satellite Receiver output channel (03 or 04).

Helpful Hints

- When you play a tape, make sure the Cable Box/Satellite Receiver is set to the same channel as the RF output channel of the DVD/VCR (03 or 04). Set the TV to the Cable Box/Satellite Receiver output channel (03 or 04).
- If your Cable Box or Satellite Receiver has Audio and Video Out jacks, use audio and video cables to connect them to the VCR AUDIO IN and VIDEO IN jacks on the rear of the DVD/VCR. You will not need the RF coaxial cable connection between the Cable Box/Satellite Receiver and the DVD/VCR as described at step 2.

DVD/VCR to a TV that has Audio and Video In jacks

Using the supplied red, white, and yellow cables

This connection will let you use the features of both the VCR and the DVD Player.

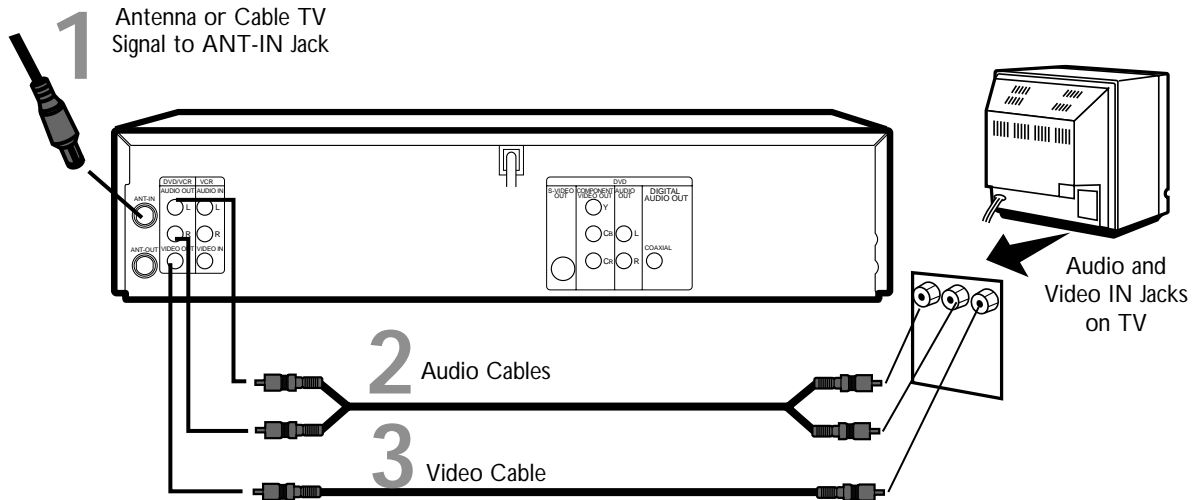

- 1** Connect the antenna or Cable TV signal to the **ANT-IN (Antenna In)** jack of your DVD/VCR.
- 2** Connect the red and white audio cables (supplied) to the red and white DVD/VCR **AUDIO OUT** jacks on the DVD/VCR and to the red and white **AUDIO IN** jacks on the TV. Match the cable colors to the jack colors. If the TV has a single **AUDIO IN** jack, use the white audio cable to connect the DVD/VCR's white DVD/VCR **AUDIO OUT** (left) jack to the TV's **AUDIO IN** jack. You will not use the red cable. Or, purchase a "splitter" audio cable to go from the left/right **AUDIO OUT** jacks of the DVD/VCR to the TV's single **AUDIO IN** jack.
- 3** Connect the yellow video cable (supplied) to the DVD/VCR **VIDEO OUT** jack on the DVD/VCR and to the **VIDEO IN** jack on the TV. The **VIDEO IN** jack on the TV is usually yellow and may be labelled **CVBS**, **Composite**, or **Baseband** video.
- 4** Connect the power cords of the TV and the DVD/VCR to a power outlet. Turn on the TV and set it to the correct **Audio/Video In channel**. Go to your lowest TV channel (01 or 02), then change channels downward until you see VCR or DVD playback on the TV screen. To help you find the right Audio/Video In channel, turn on the DVD/VCR. Press DVD to put the DVD/VCR in DVD mode. With no Disc in the Player, a large DVD Video logo will appear on the TV screen when you get the TV on the correct Audio/Video In channel.
- 5** You are ready to turn on the DVD/VCR. Go to page 17 to complete the first-time setup.

12 Hookups (cont'd)

DVD/VCR to a TV that has Component Video In jacks

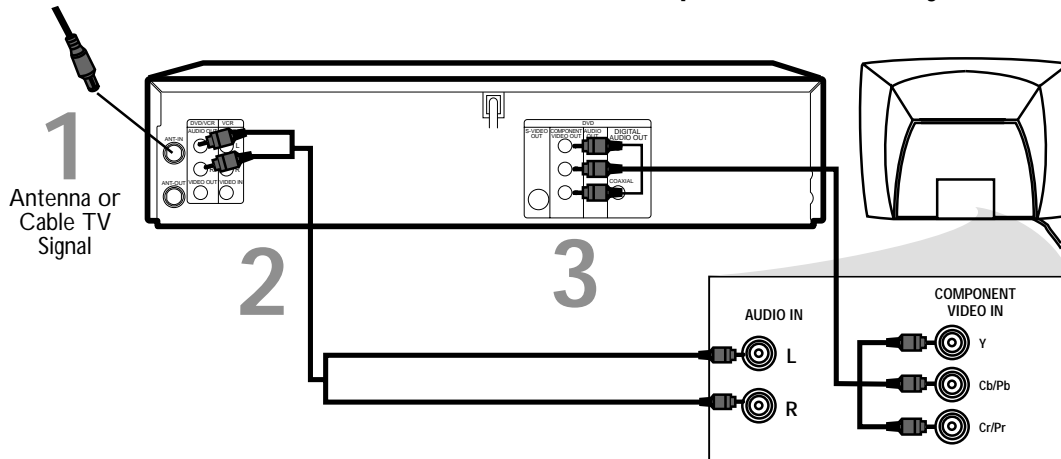

- 1** Connect the antenna or Cable TV signal to the ANT-IN (Antenna In) jack of your DVD/VCR.
- 2** Connect the supplied red and white audio cables to the red and white DVD/VCR AUDIO OUT Jacks on the DVD/VCR and to the red and white AUDIO IN jacks on the TV. Match the cable colors to the jack colors.
- 3** Connect component video cable (not supplied) to the COMPONENT VIDEO OUT jacks on the DVD/VCR and to the COMPONENT VIDEO IN jacks on the TV. The Component Video In jacks on the TV are usually red, blue, and green.
The Component Video connection only supplies video (picture) for the DVD Player of the DVD/VCR. Therefore, in order to use the VCR features or view TV channels at the DVD/VCR, you still need to either connect the RF coaxial cable between the ANT-OUT jack of the DVD/VCR and the TV's Antenna In jack, or connect the yellow video cable. To connect the supplied RF coaxial cable, see step 2 on page eight. To connect the supplied yellow video cable, see step 3 on page 11.
- 4** Connect the power cords of the DVD/VCR and TV to a power outlet. Turn on the TV and set it to the Component Video In channel for DVD Player features.
If you are using the RF coaxial cable for VCR playback, choose channel 3 or 4 at the TV. If you are using the yellow video cable for VCR playback, choose the Video In channel at your TV.
Go to your lowest TV channel and change channels down until you see VCR or DVD playback on the TV screen, or try channel 3 or 4 at the TV.
To help you find the right Audio/Video In channel, turn on the DVD/VCR. Press DVD to put the DVD/VCR in DVD mode. With no Disc in the Player, a large DVD Video logo will appear on the TV screen when you get the TV on the correct Component Video In channel.
- 5** You are ready to turn on the DVD/VCR. Go to page 17 before turning on the DVD/VCR.
- 6** After you complete the VCR setup as described on page 17, set DOLBY DIGITAL to OFF in the DVD Player's Setup menu. *Details are on page 68.* If you play a DVD when the settings are wrong, the sound will be distorted or you may damage the TV speakers.

DVD/VCR to a TV that has an S-Video In jack

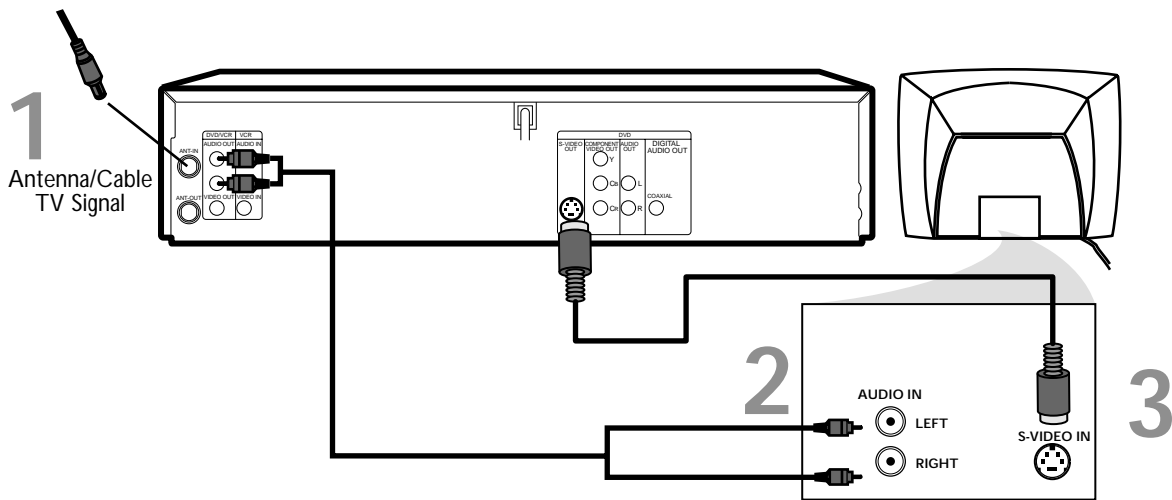

- 1** Connect the antenna or Cable TV signal to the ANT-IN (Antenna In) jack of your DVD/VCR.
- 2** Connect the supplied red and white audio cables to the red and white DVD/VCR AUDIO OUT Jacks on the DVD/VCR and to the red and white AUDIO IN jacks on the TV. Match the cable colors to the jack colors.
- 3** Connect an S-Video cable (not supplied) to the S-VIDEO OUT jack on the DVD/VCR and to the S-VIDEO IN jack on the TV.
The S-Video connection only supplies video (picture) for the DVD Player of the DVD/VCR. Therefore, in order to use the VCR features or view TV channels at the DVD/VCR, you still need to either connect the RF coaxial cable between the ANT-OUT jack of the DVD/VCR and the TV's Antenna In jack, or connect the yellow video cable. To connect the supplied RF coaxial cable, see step 2 on page eight. To connect the supplied yellow video cable, see step 3 on page 11.
- 4** Connect the power cords of the DVD/VCR and TV to a power outlet. Turn on the TV and set it to the S-Video In channel for DVD Player features.
 If you are using the RF coaxial cable for VCR playback, choose channel 3 or 4 at the TV. If you are using the yellow video cable for VCR playback, choose the Video In channel at your TV. To find the correct Video In channel, go to your lowest TV channel and change channels downward until you see VCR or DVD playback on the TV screen, or try channel 3 or 4 at the TV.
 To help you find the right S-Video In channel, turn on the DVD/VCR. Press DVD to put the DVD/VCR in DVD mode. With no Disc in the Player, a large DVD Video logo will appear on the TV screen when you get the TV on the S-Video In channel.
- 5** You are ready to turn on the DVD/VCR. Go to page 17 before turning on the DVD/VCR.
- 6** After you complete the VCR setup as described on page 17, set DOLBY DIGITAL to OFF in the DVD Player's Setup menu. *Details are on page 68.* If you play a DVD when the settings are wrong, the sound will be distorted or you may damage the TV speakers.

14 Hookups (cont'd)

DVD/VCR to a TV and a Stereo

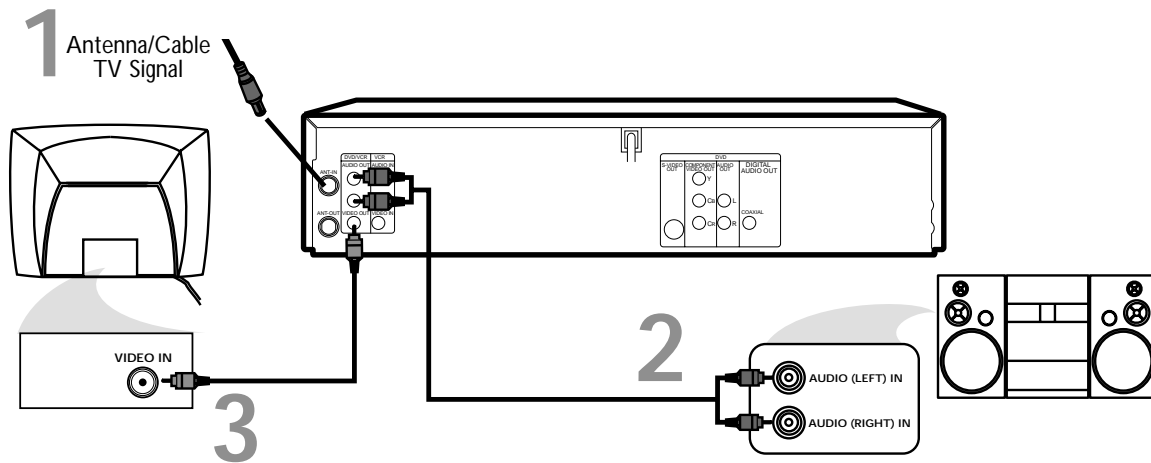

- 1** Connect the antenna or Cable TV signal to the ANT-IN (Antenna In) jack of your DVD/VCR.
- 2** Connect the supplied red and white audio cables to the red and white DVD/VCR AUDIO OUT Jacks on the DVD/VCR and to the red and white AUDIO IN jacks on the Stereo. Match the cable colors to the jack colors.
- 3** Connect the supplied yellow video cable to the DVD/VCR VIDEO OUT jack on the DVD/VCR and to the VIDEO IN jack on the TV.
To use Component Video cable or S-Video cable instead for the DVD Player, see pages 12-13. You will still need the yellow video cable or RF coaxial cable for VCR features.
- 4** Connect the power cords of the DVD/VCR, TV, and Stereo to a power outlet. Turn on the TV and set it to the Video In channel. Or, simply go to your TV's lowest channel (02 or 03) and continue changing channels downward at the TV until you see VCR or DVD playback on the TV screen.
To help you find the right Video In channel at the TV, turn on the DVD/VCR. Press DVD to put the DVD/VCR in DVD mode. With no Disc in the Player, a large DVD Video logo will appear on the TV screen when you get the TV on the correct Video In channel.
- 5** You are ready to turn on the DVD/VCR. Go to page 17 before turning on the DVD/VCR.
- 6** After you complete the VCR setup as described on page 17, set DOLBY DIGITAL to OFF in the DVD Player's Setup menu. *Details are on page 68.* If you play a DVD when the settings are wrong, the sound will be distorted or you may damage the speakers.

DVD/VCR to a TV and to a Stereo that is Dolby Digital-compatible Using Digital Audio connections

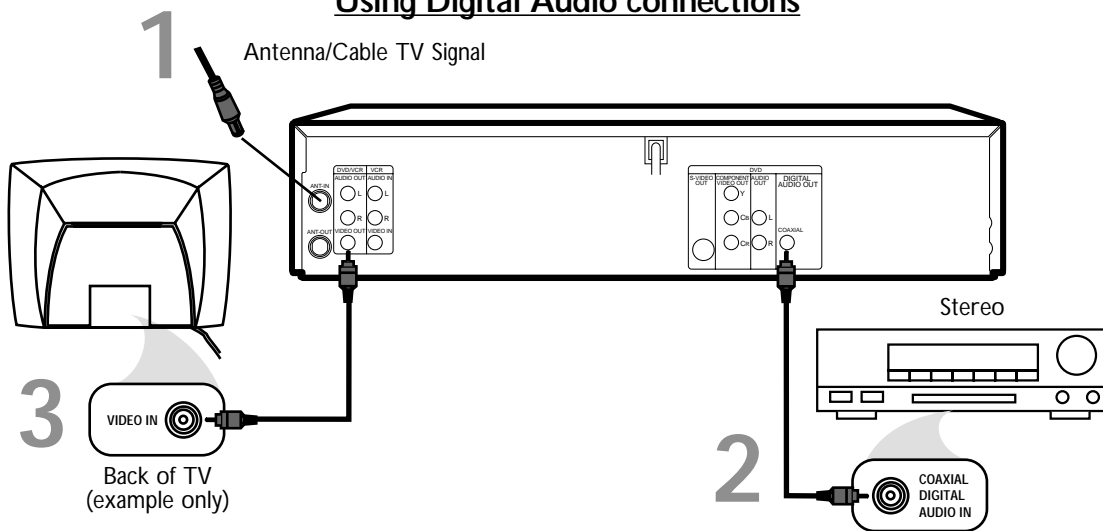

- 1** Connect the antenna or Cable TV signal to the ANT-IN (Antenna In) jack of your DVD/VCR.
- 2** Connect a coaxial digital audio cable (not supplied) to the DVD/VCR's COAXIAL DIGITAL AUDIO OUT jack and to the COAXIAL DIGITAL AUDIO IN jack on the Stereo.
This digital audio connection only provides sound for the DVD Player of the DVD/VCR. So, in order to use the VCR features or view TV channels at the DVD/VCR, you still need to either connect the RF coaxial cable between the ANT-OUT jack of the DVD/VCR and the TV's Antenna In jack, or connect the supplied red/white audio cables. To connect the supplied RF coaxial cable, see step 2 on page eight. To connect the red/white audio cables, see step 2 on page 11.
- 3** Connect the supplied yellow video cable to the yellow DVD/VCR VIDEO OUT jack on the DVD/VCR and to the VIDEO IN jack on the TV. To use component video cable or S-Video cable instead for the DVD Player, see pages 12-13. You will still need the yellow video cable or RF coaxial cable for VCR features.
- 4** Plug in the power cords of the Stereo, TV, and DVD/VCR. Turn on the Stereo and select its Auxiliary IN channel. Turn on the TV and set it to the correct Video In channel. Go to your TV's lowest channel (01 or 02) and change channels downward until you see DVD or VCR material on the TV screen. To help you find the right Video In channel on the TV, turn on the DVD/VCR. Press DVD to put the DVD/VCR in DVD mode. With no Disc in the Player, a large DVD Video logo will appear on the TV screen when you get the TV on the correct Video In channel.
- 5** You are ready to turn on the DVD/VCR. Go to page 17 before turning on the DVD/VCR.

Remember...

Some DVDs are recorded in 5.1 channel Dolby Digital Surround. Select 5.1 channel Dolby Digital Surround Sound in the DVD Disc menu. If Dolby Digital Surround is not recorded on the Disc, you will not have surround sound available.

If you connect the DVD/VCR to a Dolby Digital Stereo, set DOLBY DIGITAL to ON in the DVD Player's Setup menu. *Details are on page 68.* If the DVD/VCR is not connected to a Dolby Digital-compatible Stereo, set DOLBY DIGITAL to OFF. Incorrect settings may cause noise distortion and damage the speakers.

16 Remote Control Setup

Putting Batteries in the Remote Control

- 1** Remove the battery compartment lid on the bottom of the remote control by pressing the tab, then lifting the lid.
- 2** Place two AA batteries inside the battery compartment with their + and - ends aligned as indicated.
- 3** Replace the battery compartment lid.

Using the Remote Control

- Point the remote control at the DVD/VCR's remote sensor (marked IR, see page 22) when using the remote to operate the DVD/VCR. Do not point the remote at the TV.
- Do not put objects between the remote and the DVD/VCR.

Recycling Guidelines/Battery Safety

- Your new product and its packaging contain materials that can be recycled and reused. Specialized companies can recycle your product to increase the amount that needs to be properly disposed. Your product uses batteries that should not be thrown away when depleted but should be disposed of as small chemical waste. Please find out about the local regulations on disposal of your old product, batteries, and packaging whenever you replace existing equipment.
- Battery Usage CAUTION - To prevent battery leakage that may result in bodily injury, property damage, or damage to the unit:
Install ALL batteries correctly, with the + and - markings on the battery aligned as indicated on the unit;
Do not mix batteries, for example, old with new or carbon with alkaline; and
Remove batteries when the unit will not be used for a long time.

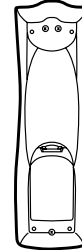
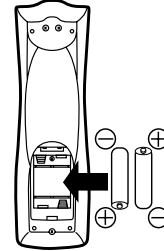
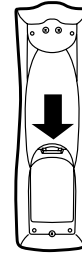

First-time DVD/VCR Setup 17

Before turning on your DVD/VCR, make sure batteries are in the remote control and the DVD/VCR and TV are connected correctly. You cannot program channels if you are using a Cable Box or a Satellite Receiver.

These menus may not appear if you have already turned on the DVD/VCR.

1 Turn on the TV. Set it to channel 3 or 4 or its AUDIO/VIDEO IN channel, depending on how you connected the DVD/VCR to a TV.

2 Press STANDBY-ON. The green VCR light and the red STANDBY-ON light will appear on the front of the DVD/VCR. The display shown below will appear. These menus may not appear if you have already turned on the DVD/VCR before to find the Audio/Video In channel of the TV, for example. If so, follow the steps on page 26 to set up channels and page 30 to select a language for the VCR menus.

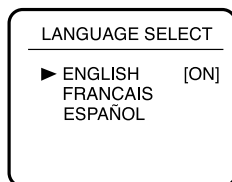

3 Press ▲ or ▼ to select English, French, or Spanish as the language for VCR on-screen displays and menus. Then, press ▶.

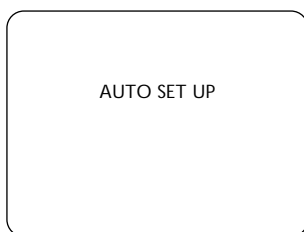

4 Press ▶ to begin channel programming. AUTO SETUP will flash on the TV screen during the channel search. The DVD/VCR will memorize all available channels. When channel programming is complete, the lowest available channel will appear on the TV. These channels will be available when you want to watch TV while in VCR mode. To put the DVD/VCR in VCR mode, press VCR so the green VCR light appears. Use the SKIP ►►I/CH▲ and SKIP I◄◄/CH▼ buttons to select memorized channels. To select non-memorized channels, use the Number buttons.

1 Turn on the TV.

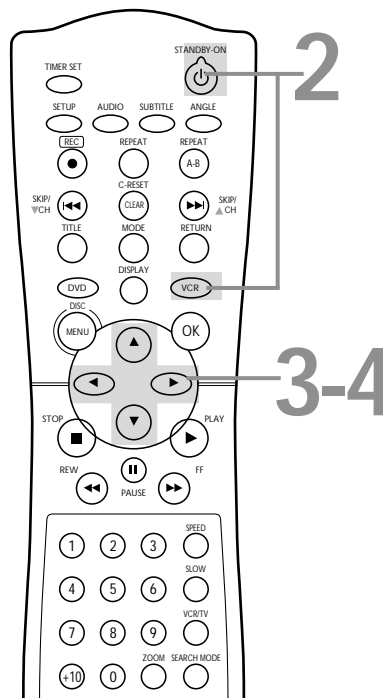

Helpful Hints

- To skip this feature and play a tape immediately, insert a tape with its record tab removed.
- To skip step 3, press DISC/MENU. VCR menus and displays will be in English.
- If you try to program channels when there is no antenna or Cable TV signal connected to the ANT-IN jack of the DVD/VCR, programming will stop. AUTO SET UP will stop flashing. Connect an antenna or Cable TV signal to the DVD/VCR's ANT-IN jack and press ▶ again.
- Repeat this process if the power fails.
- To stop the Channel Setup while AUTO SET UP is flashing, press DISC MENU.

18 Video Cassette Playback

Read and follow the steps below to play a tape.

- 1 Turn on the TV. Set it to channel 3 or 4 or its AUDIO/VIDEO IN channel.** This depends on how you connected the DVD/VCR to a TV.
Details are on pages 7-15.
- 2 With the DVD/VCR power off, insert a tape in the cassette compartment of the DVD/VCR.** The STANDBY-ON and VCR lights will appear on the front of the DVD/VCR. If the tape's record tab has been removed, playback will start automatically. If the DVD/VCR power is already on, press VCR to put the DVD/VCR in VCR mode if necessary. The green VCR light will appear on the front of the DVD/VCR.
- 3 If playback does not start automatically, press VCR, then press PLAY ►.**
- 4 Press STOP ■ to stop playback.**
- 5 Press REW ◀◀ to rewind the tape.**
- 6 After the tape stops, press STOP/EJECT ■▲ on the front of the DVD/VCR to remove the tape.**

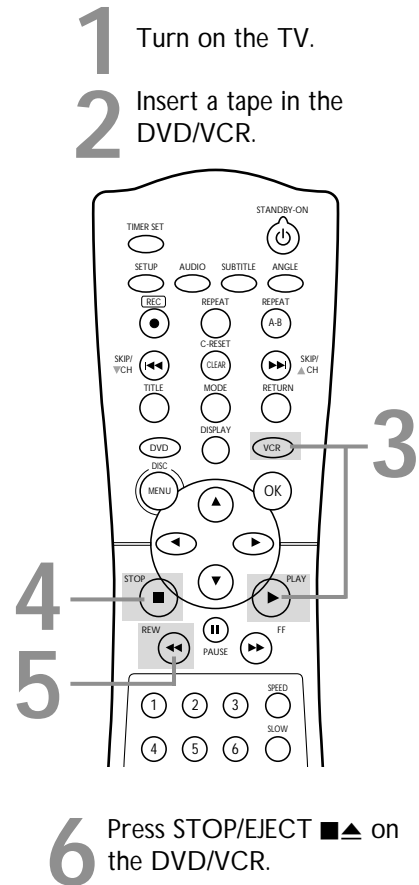

- 6 Press STOP/EJECT ■▲ on the DVD/VCR.**





Helpful Hints

- Other tape playback features are on pages 40-47.
- If AUTO REPEAT is ON, playback will begin when you insert a tape, even when the record tab is intact. Details are on page 40.
- You must connect the DVD/VCR to a TV using the RF coaxial cable or the audio/video cables in order to use the VCR features. These hookups are explained on pages eight and 11.

Disc Playback 19

Before you begin, turn on the TV, Stereo, and other equipment connected to the DVD/VCR. Make sure the TV and the Stereo (if applicable) are set to the correct channel.

Details are on pages 7-15.

- 1** Press **STANDBY-ON** to turn on the DVD/VCR.
- 2** Press **DVD** so the red DVD light appears on the front of the DVD/VCR.
- 3** Press **OPEN/CLOSE**  (to the right of the disc tray on the front of the DVD/VCR) to open the Disc tray.
- 4** Place a Disc into the tray. If the DVD is recorded on only one side, place the Disc in the tray with the label facing up and the shiny side facing down. Some DVDs are recorded on both sides. Make sure the label of the side you want to play is facing up.
- 5** Press **PLAY** . The tray will close and play will begin at the first Chapter or Track. If a DVD menu appears instead, see page 48. With some Audio CDs, playback will not begin unless you press **PLAY** .
Or, press **OPEN/CLOSE**  or press the tray toward the DVD/VCR to close the tray.
With MP3 and JPEG files, playback will begin from Track 1.
- 6** Press **STOP**  to stop playback.

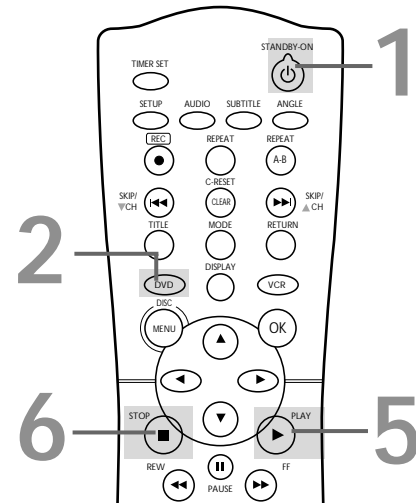

- 3** Press **OPEN/CLOSE**  on the DVD/VCR.
- 4** Insert a Disc.

Helpful Hints

- An "X" may appear at the top right corner of the TV screen when you try a feature. Either the feature is not available on the Disc, or the DVD/VCR cannot access the feature at this time. This does not indicate a problem with the DVD/VCR.
- If a Disc is dirty or scratched, the picture may appear distorted or playback may stop. Remove the Disc and turn off the DVD/VCR. Disconnect the power cord, then reconnect it. Clean the Disc, then turn on the DVD/VCR again and reinsert the Disc for playback.
- When the DVD or CD light appears on the display panel, the Disc is loaded and ready for playback.
- When you press **OPEN/CLOSE**  or **PLAY** (DVD) on the front of the DVD/VCR when the power is off, the DVD/VCR will turn on in DVD mode. Otherwise, the DVD/VCR will turn on in the mode in which it was turned off.

Remember, this DVD/VCR will play only certain Discs. See page six for details.

20 Display Panel (DVD)

Display

Messages about current Disc operations appear here. See Display Messages below.

DVD Light (red)

This light appears when the DVD/VCR is in DVD mode. You can only watch DVDs when the red DVD light is on. To make the red DVD light come on, press OUTPUT on the front of the DVD/VCR or DVD on the remote.

Disc tray
Insert a Disc here.

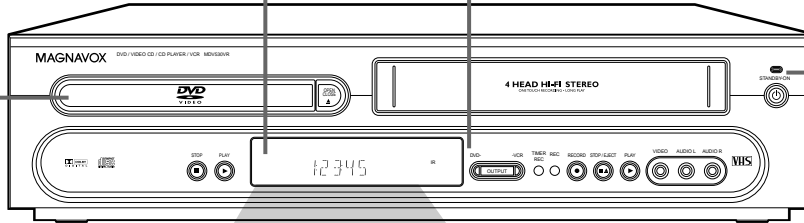

STANDBY-ON Light

This red light appears when the power is on.

REPEAT: Appears during Repeat Playback of a Disc, along with A-B, TITLE, CHP., or TRK., depending on the type of Repeat Playback you have selected. *Details are on page 53.*

A-B: Appears during A-B Repeat Playback. *Details are on page 53.*

▶: Appears during Disc playback.

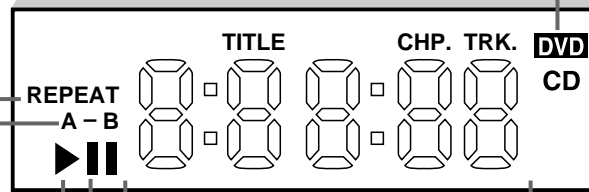

DVD: Lights when a DVD is in the tray and ready for playback.

CD: Lights when a CD is in the tray and ready for playback.

|||: Appears when play is paused.

Displays the elapsed playing time of the current Title or Track. Briefly displays Title, Chapter, or Track numbers.

Display Messages

- - - -	Appears after the disc tray closes if the tray is empty, if there is an error reading the disc, or if an unacceptable disc is installed.
OPEN	Tray is opening or is open.
CLOSE	Tray is closing.
Load	Disc is loading.

Display Panel (VCR) 21

Counter/Clock/Channel

If there is a tape in the VCR, the tape counter will appear. The remaining time will appear during a One-Touch Recording. If there is not a tape in the VCR, the current time will appear when the clock is set. An A or P will appear beside the time to indicate AM or PM. The DVD/VCR must be in VCR mode. The channel number will appear here briefly when you change TV channels.

Cassette Compartment
Insert a video cassette here.

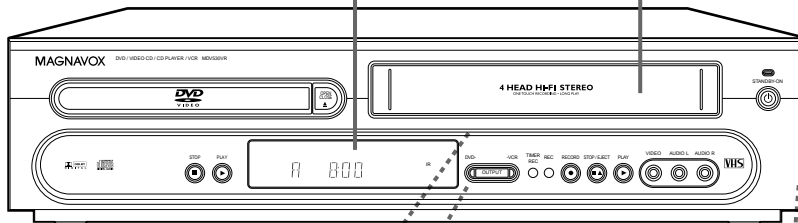

STANDBY-ON Light
This red light appears when the power is on.

VCR light (green)

This light appears when the DVD/VCR is in VCR mode. You can only watch videotapes or access VCR features and TV channels when the green VCR light is on. To make the green VCR light come on, press VCR on the remote control or OUTPUT on the front of the DVD/VCR.

REC (record) Light

This red light appears during VCR recording. It flashes when recording is paused.

TIMER REC Light

This red light glows when the DVD/VCR is set for a timer recording or during a One-Touch Recording. It flashes if a timer recording is set but no tape is in the DVD/VCR. It flashes when all timer recordings or One-Touch Recordings are finished.

22 Front Panel

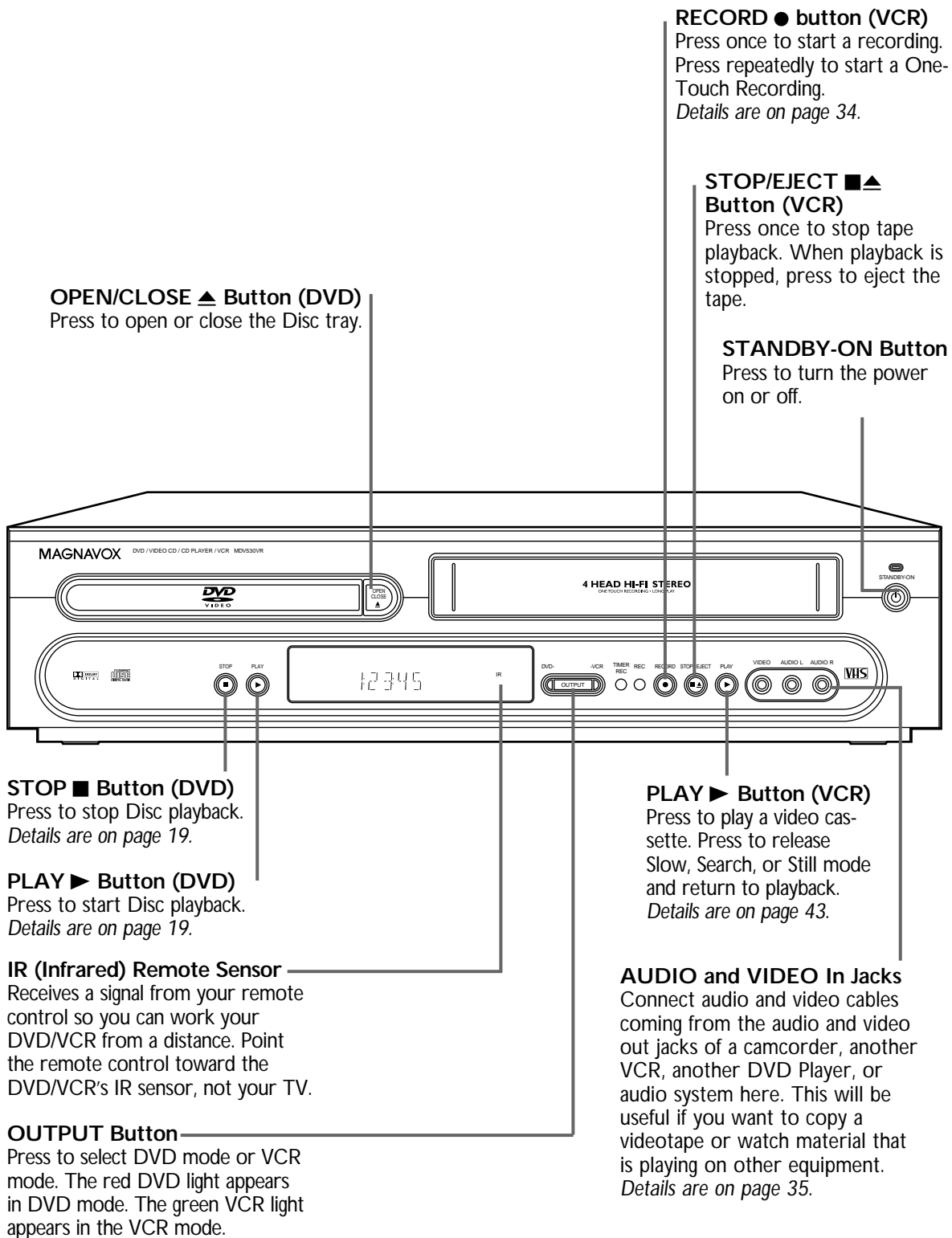

OPEN/CLOSE ▲ Button (DVD)
Press to open or close the Disc tray.

RECORD ● button (VCR)
Press once to start a recording.
Press repeatedly to start a One-Touch Recording.
Details are on page 34.

STOP/EJECT ■▲ Button (VCR)
Press once to stop tape playback. When playback is stopped, press to eject the tape.

STANDBY-ON Button
Press to turn the power on or off.

STOP ■ Button (DVD)
Press to stop Disc playback.
Details are on page 19.

PLAY ► Button (DVD)
Press to start Disc playback.
Details are on page 19.

IR (Infrared) Remote Sensor
Receives a signal from your remote control so you can work your DVD/VCR from a distance. Point the remote control toward the DVD/VCR's IR sensor, not your TV.

OUTPUT Button
Press to select DVD mode or VCR mode. The red DVD light appears in DVD mode. The green VCR light appears in the VCR mode.

PLAY ► Button (VCR)
Press to play a video cassette. Press to release Slow, Search, or Still mode and return to playback.
Details are on page 43.

AUDIO and VIDEO In Jacks
Connect audio and video cables coming from the audio and video out jacks of a camcorder, another VCR, another DVD Player, or audio system here. This will be useful if you want to copy a videotape or watch material that is playing on other equipment.
Details are on page 35.

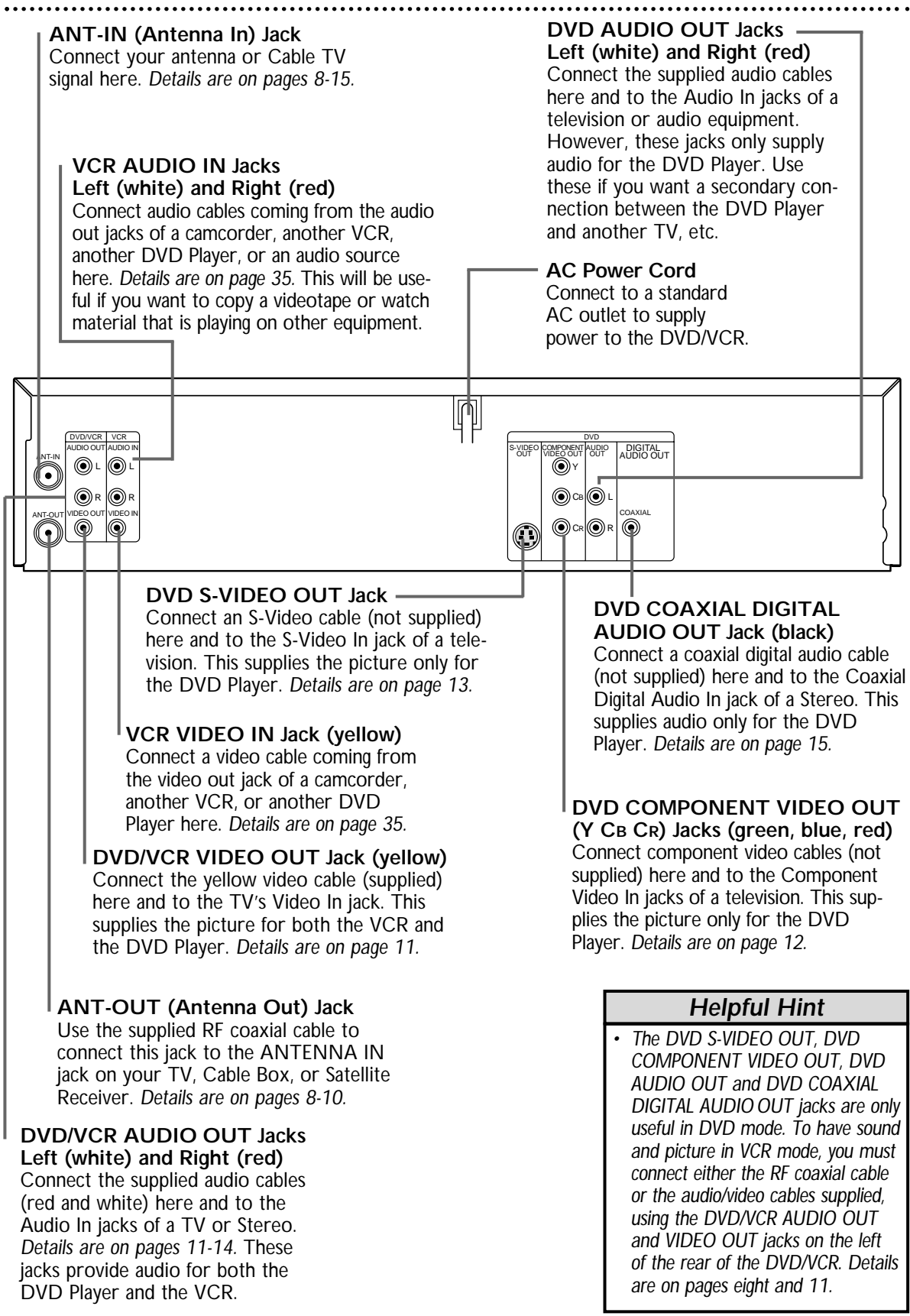

ANT-IN (Antenna In) Jack
Connect your antenna or Cable TV signal here. *Details are on pages 8-15.*

VCR AUDIO IN Jacks
Left (white) and Right (red)
Connect audio cables coming from the audio out jacks of a camcorder, another VCR, another DVD Player, or an audio source here. *Details are on page 35.* This will be useful if you want to copy a videotape or watch material that is playing on other equipment.

DVD AUDIO OUT Jacks
Left (white) and Right (red)
Connect the supplied audio cables here and to the Audio In jacks of a television or audio equipment. However, these jacks only supply audio for the DVD Player. Use these if you want a secondary connection between the DVD Player and another TV, etc.

AC Power Cord
Connect to a standard AC outlet to supply power to the DVD/VCR.

DVD S-VIDEO OUT Jack
Connect an S-Video cable (not supplied) here and to the S-Video In jack of a television. This supplies the picture only for the DVD Player. *Details are on page 13.*

VCR VIDEO IN Jack (yellow)
Connect a video cable coming from the video out jack of a camcorder, another VCR, or another DVD Player here. *Details are on page 35.*

DVD/VCR VIDEO OUT Jack (yellow)
Connect the yellow video cable (supplied) here and to the TV's Video In jack. This supplies the picture for both the VCR and the DVD Player. *Details are on page 11.*

ANT-OUT (Antenna Out) Jack
Use the supplied RF coaxial cable to connect this jack to the ANTENNA IN jack on your TV, Cable Box, or Satellite Receiver. *Details are on pages 8-10.*

DVD/VCR AUDIO OUT Jacks
Left (white) and Right (red)
Connect the supplied audio cables (red and white) here and to the Audio In jacks of a TV or Stereo. *Details are on pages 11-14.* These jacks provide audio for both the DVD Player and the VCR.

DVD COAXIAL DIGITAL AUDIO OUT Jack (black)
Connect a coaxial digital audio cable (not supplied) here and to the Coaxial Digital Audio In jack of a Stereo. This supplies audio only for the DVD Player. *Details are on page 15.*

DVD COMPONENT VIDEO OUT (Y Cb Cr) Jacks (green, blue, red)
Connect component video cables (not supplied) here and to the Component Video In jacks of a television. This supplies the picture only for the DVD Player. *Details are on page 12.*

Helpful Hint

- The DVD S-VIDEO OUT, DVD COMPONENT VIDEO OUT, DVD AUDIO OUT and DVD COAXIAL DIGITAL AUDIO OUT jacks are only useful in DVD mode. To have sound and picture in VCR mode, you must connect either the RF coaxial cable or the audio/video cables supplied, using the DVD/VCR AUDIO OUT and VIDEO OUT jacks on the left of the rear of the DVD/VCR. *Details are on pages eight and 11.*

24 Remote Control

TIMER SET Button

Press to set a timer recording that you have programmed. *Details are on pages 36-38.*

SETUP Button

Press to access or remove the DVD Player's Setup menu.

REC (record) ● Button

Press to start a VCR recording. *Details are on page 32.*

TITLE Button

Press to see a DVD Title menu. *Details are on page 48.*

DISC/MENU Button

Press to access or remove a DVD Disc menu or the VCR menu.

◀▶▲▼ Buttons

Press to select an item in a menu.

Number Buttons

In DVD mode, press to select a Track or Chapter for playback. Use the +10 button for items 10 and above. *Details are on pages 50-51.*

In VCR mode, use to select TV channels. Enter channel numbers as a two-digit number for the quickest results (to select channel 6, press 0,6). For channels 100 and above, enter a three-digit number (for channel 117, press 1, 1, 7). If you have Cable TV, channels 1-125 are available. If you have an antenna, channels 2-69 are available. The +10 button has no effect in VCR mode.

ZOOM Button

Press to enlarge the DVD or JPEG image. *Details are on page 59.*

STANDBY-ON Button

Press to turn the power on or off.

ANGLE Button

Press to see a DVD picture from a different angle. *Details are on page 55.*

A-B REPEAT Button

Press to set up A-B Repeat. *Details are on page 53.*

RETURN Button

Press to return to the previous level of the DVD Player's Setup menu or to remove the Setup menu.

OK Button

Press to confirm or select menu items.

PLAY ▶ Button

Press to begin Disc or tape playback.

FF ▶▶ (fast forward) Button

In DVD mode, press to fast forward the Disc. *Details are on page 49.* Press when DVD playback is paused to start slow motion playback. *Details are on page 59.*

In VCR mode, press to fast forward the tape. *Details are on page 43.*

SPEED Button

Press to select the VCR's recording speed (SP or SLP). *Details are on pages 30, 35, and 72.*

SEARCH MODE Button

In DVD mode, press to search for a specific Title/Chapter/Track/Time. *Details are on pages 50-51.* In VCR mode, press for a Time Search or an Index Search. *Details are on page 42.*

Helpful Hints

- For DVD Player features, press DVD before pressing other buttons. To put the DVD/VCR in DVD mode, press DVD or OUTPUT so the red DVD light appears on the front of the DVD/VCR.
- For VCR features, press VCR before pressing any other buttons. To put the DVD/VCR in VCR mode, press VCR or OUTPUT so the green VCR light appears on the front of the DVD/VCR.

Remote Control (cont'd) 25

AUDIO Button

Press to choose a DVD audio language or an Audio CD sound mode.

Details are on page 58.

REPEAT Button

Press to play a Track, Audio CD, Title, or Chapter repeatedly. *Details are on page 53.*

C-RESET/CLEAR Button

Press to remove VCR menus. Press to reset the tape counter. *Details are on page 41.* Press to reset a menu item in DVD mode.

DVD Button

Press before using the remote control for DVD features. Press to put the DVD/VCR in DVD mode.

DISPLAY Button

In VCR mode, press to see status displays. *Details are on page 31.* In DVD mode, press to access Disc information. *Details are on page 69.*

STOP ■ Button

Press to stop Disc playback, tape playback, or recording.

PAUSE ■■ Button

Press to pause Disc playback or to advance the picture one frame at a time. *Details are on page 52.* Press to pause or resume VCR recording. *Details are on page 32.* Press to pause a tape. *Details are on page 43.*

REW ◀◀ (rewind) Button

Press to fast reverse a DVD or Audio CD. *Details are on page 49.* Press to rewind a tape. *Details are on page 43.*

SUBTITLE Button

Press to select a language for DVD subtitles. *Details are on page 55.*

SKIP ▶▶/CH▲ and SKIP ◀◀/CH▼ Buttons

In DVD mode, press to skip Chapters or Tracks. In VCR mode, press to change TV channels at the DVD/VCR.

MODE Button

Press to set a Program. *Details are on page 60.* Press to start Random playback.

Details are on page 61.

VCR Button

Press before using the remote control for VCR features. Press to put the DVD/VCR in VCR mode.

SLOW Button

Press to view a videotape in slow motion. *Details are on page 43.*

VCR/TV Button

Press to select VCR or TV position. In VCR position, watch a tape or watch/record TV programs (changing channels at the VCR). Use TV position to watch TV channels (changing channels at the TV) or watch one program while recording another. *Details are on page 33.*

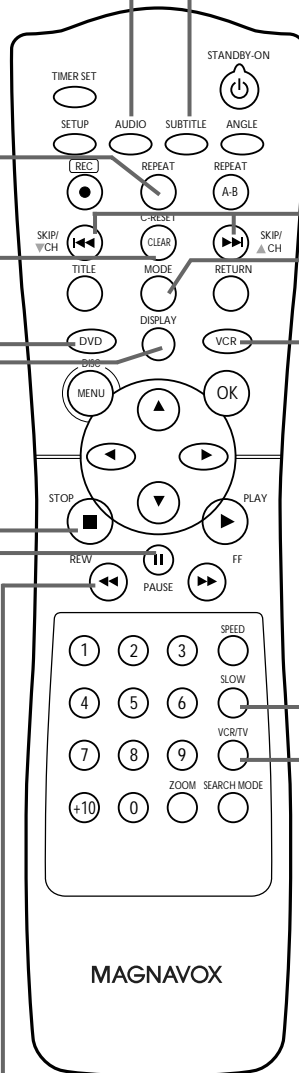

26 Channel Setup

Although your DVD/VCR may automatically memorize the channels you receive when you turn it on for the first time, you can set up the channels again.

1 Press **VCR**, then press **DISC/MENU**.

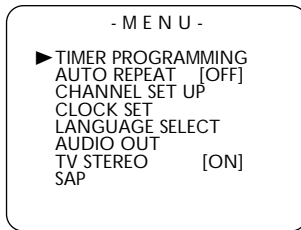

2 Press **▲** or **▼** to select **CHANNEL SET UP**. Then, press **▶**.

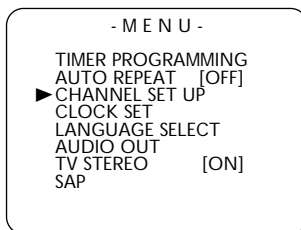

3 Press **▲** or **▼** to select **AUTO SET UP**. Press **▶**.

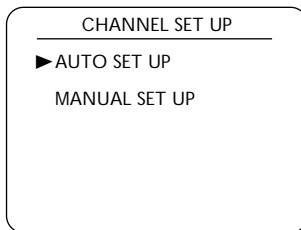

4 **AUTO SET UP** will flash while the DVD/VCR sets up the available channels. When setup is complete, the lowest available channel will appear on the TV. Now when you press **SKIP ▶▶▶/CH▲** or **SKIP ◀◀◀/CH▼**, you will scan only through available channels. You still can select any channel using the Number buttons.

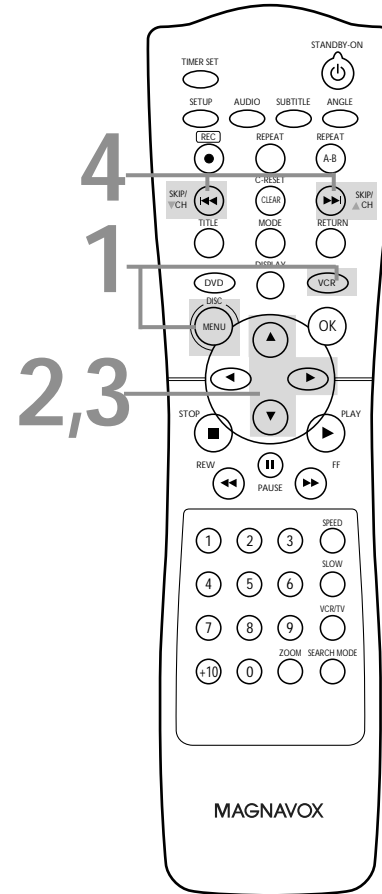

Helpful Hints

- You cannot program channels if you are using a Cable Box or Satellite Receiver.
- If you have an antenna, channels 2-69 will be available. If you have Cable TV, channels 1-125 will be available.
- To stop Channel Setup, press **DISC/MENU** while **AUTO SET UP** is flashing.

Adding/Deleting Channels

You may want to add or delete TV channels if your channel lineup changes or if you no longer watch some channels.

- 1 Press VCR, then press DISC/MENU.
- 2 Press ▲ or ▼ to select CHANNEL SET UP, then press ►.
- 3 Press ▲ or ▼ to select MANUAL SET UP, then press ►.

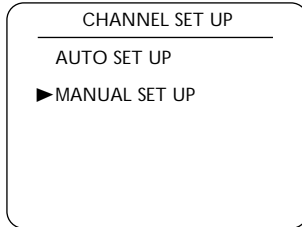

- 4 Press ▲ or ▼ until the channel number you want to add or delete appears on the screen.

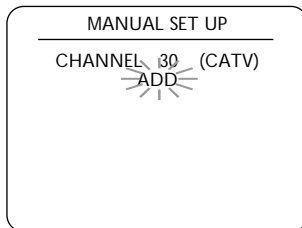

- 5 Press ► or ◀ so ADD or DELETE flashes on the screen.
- 6 While your choice is flashing, press C-RESET/CLEAR. The channel you added or deleted will be the current channel. Added channels are available when you flip through channels using the SKIP ►►/CH▲ and SKIP ◀◀/CH▼ buttons. You still can select deleted channels with the Number buttons.

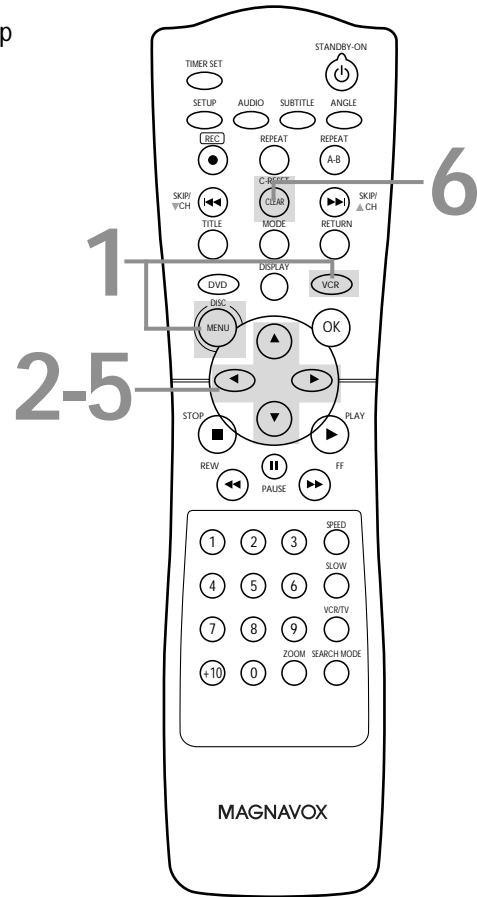

28 Clock (VCR)

Follow these steps to set the VCR clock. Make sure:

- The DVD/VCR is on and in VCR mode. Press VCR so the green VCR light appears on the front of the DVD/VCR.

- 1 Press VCR, then press DISC/MENU.
- 2 Press ▲ or ▼ to select CLOCK SET, then press ►.
- 3 While the MONTH space is flashing, press ▲ or ▼ until the month appears. Then, press ►.

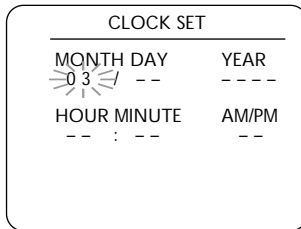

- 4 While the DAY space is flashing, press ▲ or ▼ until the day appears. Then, press ►.

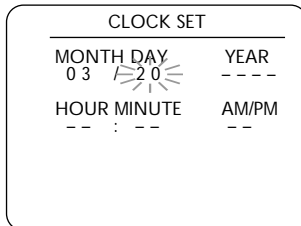

- 5 While the YEAR space is flashing, press ▲ or ▼ until the year appears. Press ►. The day of the week will appear automatically.

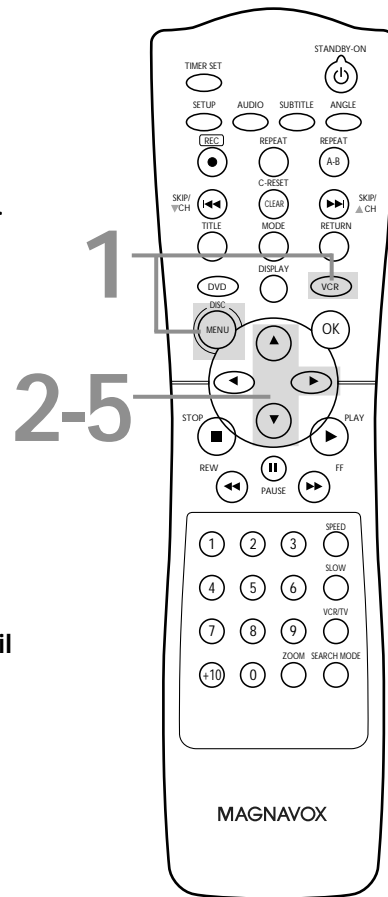
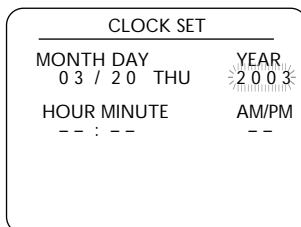

Helpful Hints

- If the clock has never been set, the CLOCK SET menu may appear when you press DISC/MENU. If so, follow the instructions from step 3 above.
- Press DISPLAY until the time appears on the TV screen.
- Power failures of more than 30 seconds can erase the clock setting.

- 6** While the HOUR space is flashing, press ▲ or ▼ until the hour appears. Then, press ►.

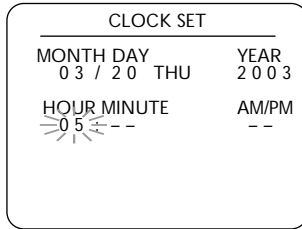

- 7** While the MINUTE space is flashing, press ▲ or ▼ until the minute appears. Then, press ►.

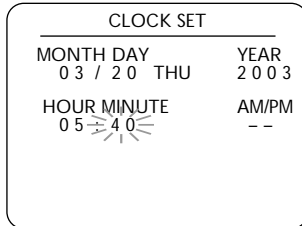

- 8** While the AM or PM space is flashing, press ▲ or ▼ to point to AM or PM. Your selection will flash on the screen in the AM/PM space.

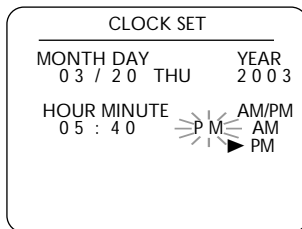

- 9** Press C-RESET/CLEAR or ► to start the clock.

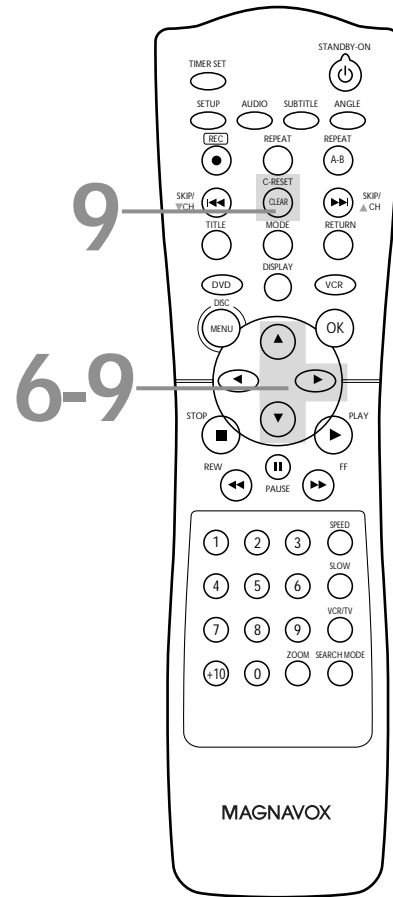

Helpful Hint

- To reset the clock, follow steps 1-2 on page 28. Select the information you want to change using ► or ◀. When the information is flashing, use ▲ or ▼ to enter the correct information. Press C-RESET/CLEAR to set the clock.

30 Language (VCR)

Follow the steps below to change the language of the VCR on-screen displays and menus.

1 Press VCR, then press DISC/MENU.

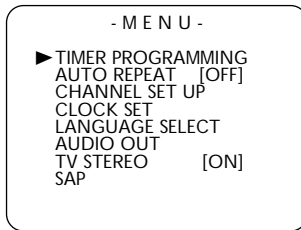

2 Press ▲ or ▼ to choose LANGUAGE SELECT, then press ▶.

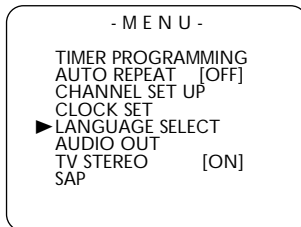

3 Press ▲ or ▼ to choose ENGLISH, FRANCAIS (French), or ESPANOL (Spanish).

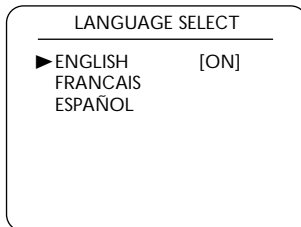

4 Press C-RESET/CLEAR to remove the menu.

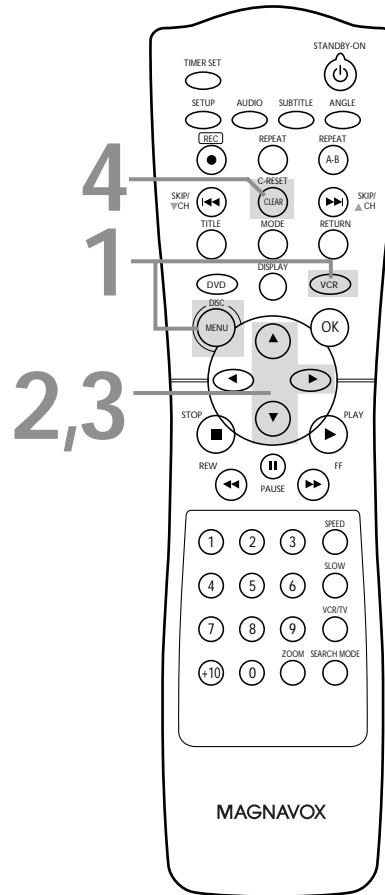

Helpful Hint

- If you select French or Spanish and need English:
 - 1) Press DISC/MENU so MENU appears.
 - 2) Press ▼ to choose SELECTION LANGUE or SELEC. IDIOMA, then press ▶.
 - 3) Press ▲ or ▼ to select ENGLISH.
 - 4) Press C-RESET/CLEAR.

VCR Status Displays 31

You may access status displays by pressing DISPLAY. The displays may include the current time, channel, and other information.

- 1 Press DISPLAY.** The COUNT display will appear for five seconds. After five seconds, only the real-time tape counter will appear. This counter shows you the elapsed playing time of the tape (from the point at which the counter was set to zero). The counter also will appear on the display panel on the front of the DVD/VCR.

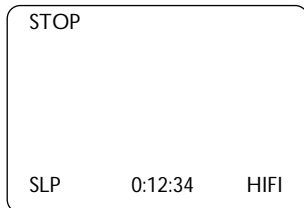

- 2 Press DISPLAY again.** The CLOCK display will appear for five seconds. After five seconds, only the time will appear (the clock must be set). (If you are watching TV, the channel number and the availability of stereo or second audio will also appear.) The time also will appear on the display panel on the front of the DVD/VCR.

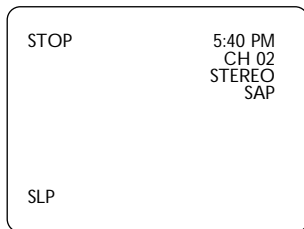

- 3 Press DISPLAY again to remove all the displays.**

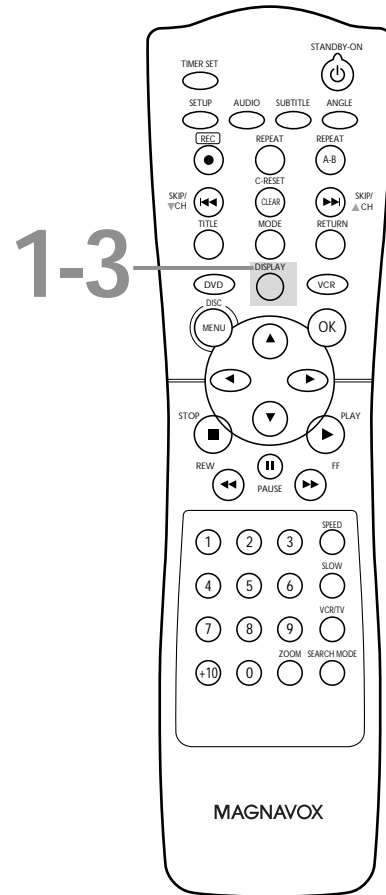

Helpful Hints

- If the channel you select has no broadcast, the screen will be solid blue.
- You cannot access a status display when viewing a still picture, during slow motion, or during forward and reverse searching.
- Channel numbers appear on the screen for a few seconds each time you change channels.

32 Videotape Recording

Read and follow the steps below to record a television program onto a videotape. Before you begin, make sure the DVD/VCR is in VCR mode. Press VCR so the green VCR light appears on the front of the DVD/VCR.

- 1 Turn on the TV and set it to channel 3 or 4 or the Video In channel.** If you connected the DVD/VCR to the TV using the supplied audio and video cables, select your TV's Video In channel. *Details are on page 11.* If you connected the DVD/VCR to the TV using the supplied RF coaxial cable, choose channel 3 (or 4) at the TV. *Details are on pages 8-10.*
- 2 Insert a tape with its record tab intact into the cassette compartment of the DVD/VCR.** If tape playback begins, press STOP ■.
- 3 Press SPEED until the desired tape speed (SP or SLP) appears briefly on the screen.** *Details about tape speed are on page 72.*
- 4 Press SKIP ►►/CH▲ or SKIP ◄◄/CH▼ or the Number buttons to select the TV channel to record.**
- 5 Press REC ● to start recording.** The red REC light will appear on the front of the DVD/VCR.
- 6 To pause the recording, press PAUSE ■■ once.** The red REC light will flash. **To resume recording, press REC ● or press PAUSE ■■ again.** The red REC light will come on again.
- 7 To stop recording, press STOP ■.**

Recording Prevention

Video Cassettes have record tabs to ensure that recordings are not accidentally erased.

- 1 To prevent recording, break off the tab with a screwdriver.**
- 2 To allow recording, cover the hole with clear tape.**



- 1** Turn on the TV.
- 2** Insert a tape in the DVD/VCR.

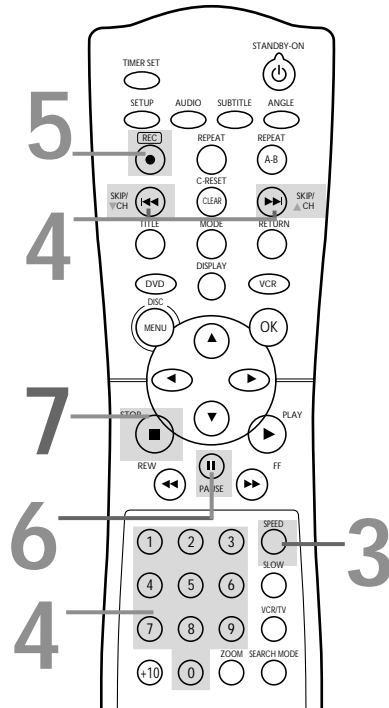

Helpful Hints

- Other recording options are on pages 33-39.
- The VCR will record in a preset volume.
- Pause will switch to Stop after five minutes to protect the VCR and the tape from damage. When a recording is paused, review the pause time remaining with the ■ marks on the screen. Each ■ mark equals one minute remaining. During the last minute of paused recording, the ■ mark will flash.
- If any menu is on the TV screen, the REC ● button on the remote does not function. Press C-RESET/CLEAR to remove the menu. Then, press REC ●. Or, use the RECORD ● button on the front of the DVD/VCR.

Recording One Channel/Watching Another 33

- 1 Press VCR, then press REC ● to record the current TV channel. *Details are on page 32.*
- 2 Press VCR/TV once to put the DVD/VCR in TV position.
- 3 Use the TV remote control to select the channel you want to watch at the TV.
- 4 To return to the channel being recorded, use the TV remote control to select channel 03 or 04 at the TV. *Details are on page eight.* Or, if you connected the DVD/VCR to the TV using audio and video cables, select the TV's correct Video In channel. *Details are on page 11.*
- 5 Press VCR/TV on the DVD/VCR remote control to put the DVD/VCR in VCR position. The channel being recorded will appear on the TV screen.
- 6 Press STOP ■ to stop the recording.

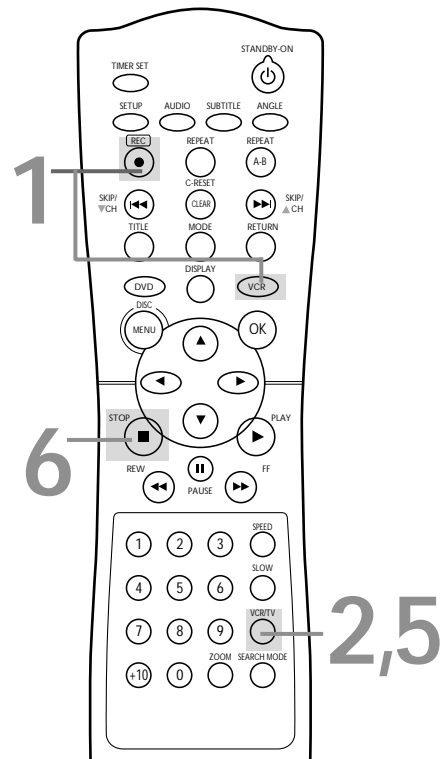

- 3 Select the channel you want to watch at the TV.
- 4 Select channel 03, 04, or Video In at the TV.

Helpful Hint

- If you use a Cable Box or Satellite Receiver, you may not be able to watch one channel while recording another. See pages 9-10 for details.

34 One-Touch Recording

One-Touch Recording (OTR) lets you set a timed recording 30 minutes to eight hours long. Before you begin:

- Place the DVD/VCR in VCR mode. Press VCR so the green VCR light appears on the front of the DVD/VCR.
- Select a recording speed (SP, SLP) with the SPEED button.
- Put a videotape in the cassette compartment. Make sure the tape's record tab is intact and the tape is long enough to record the program(s).

1 Press VCR, then press SKIP ►►/CH▲ or SKIP ◀◀/CH▼ or the Number buttons to select the channel you want to record.

2 Press RECORD ● on the front of the DVD/VCR until the desired recording length (30 minutes to eight hours) appears on the TV screen. Recording will begin. The REC light and the TIMER REC light will appear on the front of the DVD/VCR.

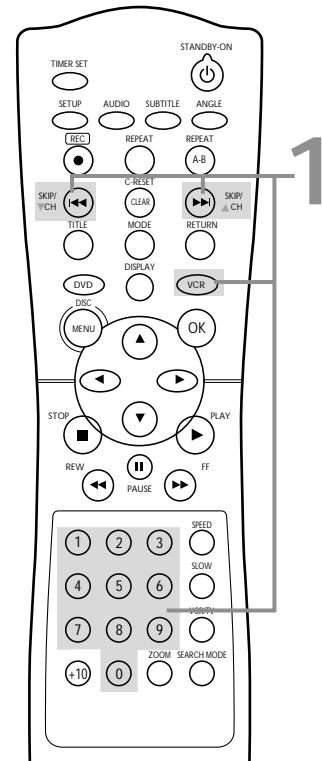
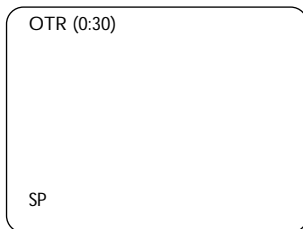

2 Press RECORD on the DVD/VCR.

Stopping an OTR

To stop an OTR before recording is finished, press STOP on the remote control or STOP/EJECT ■▲ on the front of the DVD/VCR.

To cancel the OTR but continue recording, press RECORD on the front of the DVD/VCR repeatedly until REC appears in the upper left corner of the screen.

When an OTR finishes, the DVD/VCR will either switch to DVD model or turn itself off. If it changes to DVD mode, press STANDBY-ON to turn it off.

After an OTR, the TIMER REC light flashes because the VCR is still on standby for timer recordings. Press TIMER SET on the remote or STOP/EJECT ■▲ on the DVD/VCR to cancel timer standby and use the VCR normally again.

Helpful Hints

- The remaining recording time will appear on the display panel. Press DISPLAY to see it on the TV screen.
- To change the recording length while an OTR is in progress, press RECORD on the front of the DVD/VCR.
- You cannot start a timed OTR with the REC ● button on the remote.
- You cannot pause an OTR.
- If the preset time for a timer recording comes up during an OTR, the OTR has priority. The timer recording will not take place.
- If the end of the tape is reached during an OTR, the VCR will stop recording, eject the tape, and switch to DVD mode or turn off.

Rerecording (Tape Duplication) 35

These instructions show you how to copy videotapes. The illustration uses two DVD/VCRs. Other VCRs or Camcorders may operate differently.

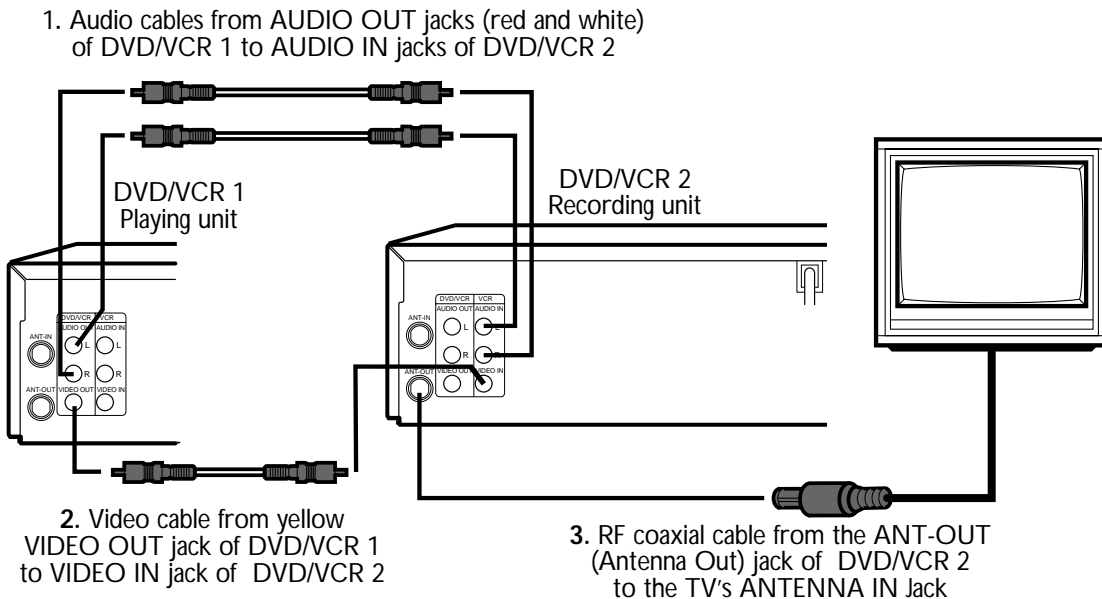

- 1 Make the connections shown above.
- 2 DVD/VCR 1 will play your tape. **Put a prerecorded tape into the cassette compartment of DVD/VCR 1.** Press VCR to put the unit in VCR mode if necessary.
- 3 DVD/VCR 2 will record your tape. **Insert a blank tape in the cassette compartment of DVD/VCR 2.** Press VCR to put the unit in VCR mode if necessary.
- 4 **Turn on the TV and set it to channel 03 or 04** (the RF output channel of DVD/VCR 2). To determine the DVD/VCR's output channel, see step 4 on page eight.
- 5 **Point the remote control at DVD/VCR 2. Press Number buttons 0, 0, 1 or 0, 0, 2.** (See *Helpful Hints* at right.)
- 6 Press **SPEED** to select SP or SLP at DVD/VCR 2.
- 7 Press **PLAY ► (VCR)** on the front of DVD/VCR 1 and **RECORD ●** on the front of DVD/VCR 2 at the same time.
To stop recording, press **STOP/EJECT ■▲** on DVD/VCR 1, then press **STOP/EJECT ■▲** on DVD/VCR 2.

Helpful Hints

- If you use the **AUDIO and VIDEO IN** jacks on the back of DVD/VCR 2, press Number buttons 0, 0, 1 at step 5. L1 will appear on the TV screen.
- If you use the **AUDIO and VIDEO In** jacks on the front of DVD/VCR 2, press Number buttons 0, 0, 2 at step 5. L2 will appear on the TV screen.
- *Unauthorized recording of copyrighted television programs, video tapes, or other materials may infringe on the rights of copyright owners and violate copyright laws.*
- *If a program has copyright protection, it may not record clearly.*
- *You cannot record DVD material onto a video cassette using a single unit.*

36 Timer Recording

Follow the steps below to program the VCR of the DVD/VCR to record TV programs while you're away from home. Before you begin:

- Set up the TV channels at the DVD/VCR. *Details are on page 26.*
- Set the clock. *Details are on pages 28-29.*
- Put a tape in the cassette compartment of the DVD/VCR. Make sure the tape's record tab is intact and the tape is long enough to record the program(s).
- Press VCR so the green VCR light appears on the front of the DVD/VCR.

1 Press DISC/MENU so the MENU appears.

2 Press ▲ or ▼ to select **TIMER PROGRAMMING**. Then, press ►. Program numbers that do not have a timer recording stored will flash.



3 Press ▲ or ▼ to select an empty program. Then, press ►.

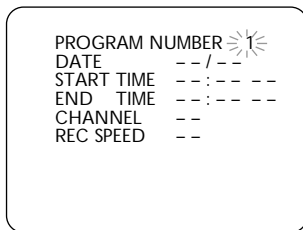

4 Press ▲ or ▼ to select **ONCE, DAILY, or WEEKLY**. Then, press ►.

- **ONCE** - The VCR will record a TV program on any day you choose, up to 12 months away.
- **DAILY** - The VCR will record a TV program at the same time on the same channel every day, Monday through Friday.
- **WEEKLY** - The VCR will record a TV program at the same time on the same channel every week, for example, every Monday.

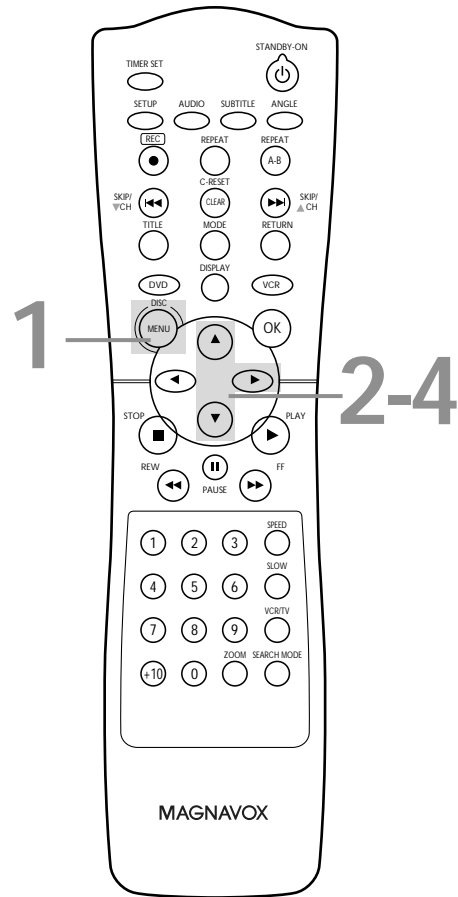
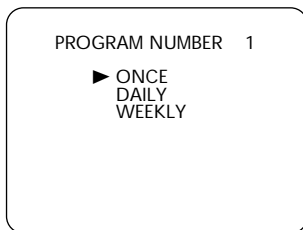

Helpful Hints

- You cannot access the **TIMER PROGRAMMING** menu at step 2 if the clock is not set. The **CLOCK SET** menu will appear. Follow the steps on pages 28-29 to set the clock.
- Only programs that will air Monday-Friday can be recorded on a **DAILY** basis. If you select **DAILY** at step 4, then enter a Saturday or Sunday **DATE** at step 5, the correct program will not be recorded. The VCR will alter the recording date and record a different program than the one you intended.

- 5** Press **▲** or **▼** until the month appears. Then, press **▶**. Next, press **▲** or **▼** until the day appears. Then, press **▶**. The day of the week will appear. You cannot record more than one year in advance.

```

ONE TIME PROGRAM
PROGRAM NUMBER 1
DATE 05/04 SUN
START TIME ---:--:--
END TIME ---:--:--
CHANNEL ---
REC SPEED --
    
```

- 6** To enter the recording's start time, press **▲** or **▼** until the hour appears. Press **▶**. Press **▲** or **▼** until the minute appears. Press **▶**. Finally, press **▲** or **▼** to point to AM or PM. AM or PM will flash beside the start time. Press **▶**.

```

ONE TIME PROGRAM
PROGRAM NUMBER 1
DATE 05/04 SUN
START TIME 07:30 P M
END TIME ---:--:--
CHANNEL ---
REC SPEED --
                AM
                ▶PM
    
```

- 7** Repeat the procedure in step 6 to set the recording's end time.

- 8** Press **▲** or **▼** until the channel number appears. Then, press **▶**.
- If you are using a standard antenna/Cable TV hookup (as shown on page eight), select the channel of the TV program you want to record.
 - If you are recording from other equipment, select L1 or L2. To determine L1 or L2, refer to the Helpful Hint below.
 - If you are using a Cable Box/Satellite Receiver, select the Cable Box/Satellite Receiver output channel (03 or 04). Then, at the Cable Box/Satellite Receiver, select the channel you want to record. Leave the Cable Box/Satellite Receiver on for the timer recording. Details are on page nine.

```

ONE TIME PROGRAM
PROGRAM NUMBER 1
DATE 05/04 SUN
START TIME 07:30 P M
END TIME 08:30 P M
CHANNEL 16
REC SPEED --
    
```

Instructions continue on page 38.

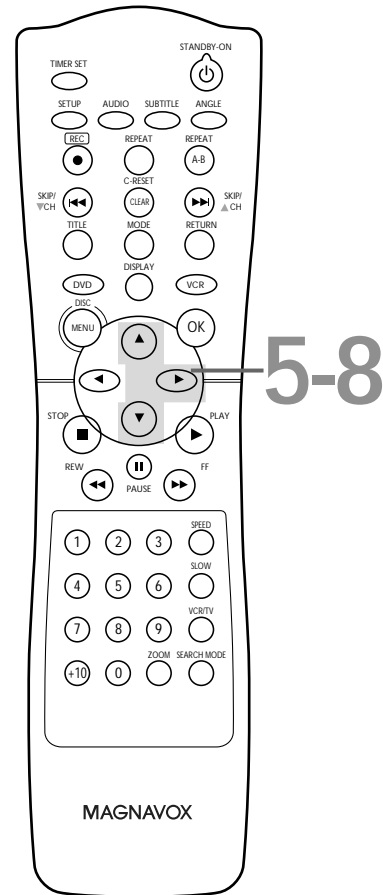

Helpful Hints

- Enter the information while the space is flashing.
- To stop a started timer recording, press STOP/EJECT **■▲** on the front of the DVD/VCR. More Helpful Hints are on page 76.

38 Timer Recording (cont'd)

- 9** Press **▲** or **▼** to select a recording tape speed. The arrow will appear beside your choice. The selected speed will flash beside REC SPEED. Details about tape speed are on page 72.

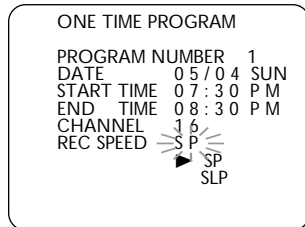

- 10** Press **C-RESET/CLEAR** to store the timer recording.

- 11** Press **TIMER SET**. The DVD/VCR will turn off and the red **TIMER REC** light will appear on the front of the DVD/VCR. In some cases, the DVD/VCR will switch to DVD mode instead. You may use the DVD Player during a timer recording.

If you want to use the VCR until time for the recording, don't press **TIMER SET** until a few minutes before the recording should start. Or, press **TIMER SET** only when you know you won't be using the VCR anymore (until after the recording). When the **TIMER REC** light is on, you cannot put the DVD/VCR in VCR mode by pressing **VCR** or **OUTPUT**. You must first press **TIMER SET** to cancel the timer recording temporarily. Then, you can use the VCR features again.

Cancelling Timer Recordings

- 1** Press **VCR**, then press **DISC/MENU**.
- 2** Press **▲** or **▼** to select **TIMER PROGRAMMING**, then press **▶**.
- 3** Press **▲** or **▼** to find the program you want to cancel.
- 4** While the program number is flashing, press **◀** to clear all the information for that program.

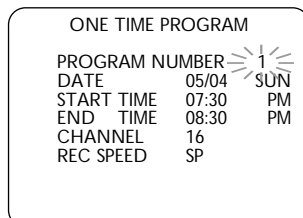

- 5** Press **C-RESET/CLEAR** to remove the menu.

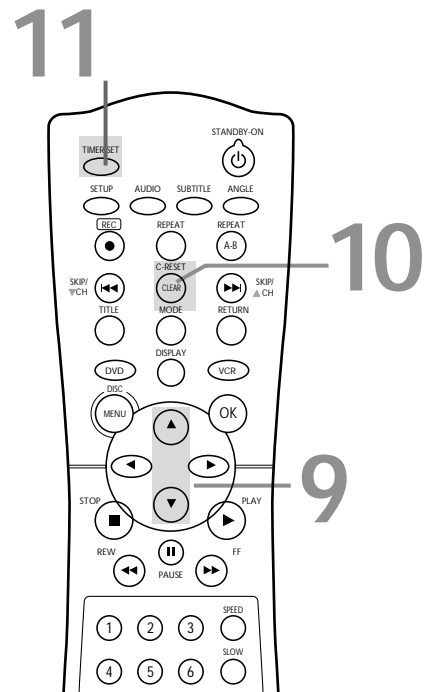

Helpful Hints

- If you are recording from other equipment, set **CHANNEL** to L1 or L2. If you connected the other equipment to the **AUDIO** and **VIDEO In** jacks on the front of the DVD/VCR, choose L2. If you connected the audio and video cables to the **AUDIO IN** and **VIDEO IN** jacks on the back of the DVD/VCR, choose L1.
- To change incorrect information, press **◀** or **▶** to choose the item you want to change. Press **▲** or **▼** to adjust the information.
- If a timer recording is set and the **TIMER REC** light is on, pressing **STOP/EJECT** **■▲** will turn on the DVD/VCR and/or cancel the timer recording. The **TIMER REC** light will turn off. Press **STOP/EJECT** **■▲** again to remove the tape. Remember to insert a tape and press **TIMER SET** to reset the timer recording.
- If there is no tape in the VCR when you press **TIMER SET**, the **TIMER REC** light will flash. Insert a tape.

DVD to Videotape Duplication 39

Follow the steps below to copy a DVD to a videotape. **This will be possible only if the DVD is not copy protected.**

Before you begin:

- Put a videotape in the cassette compartment. Make sure the tape's record tab is intact and the tape is long enough to record the DVD.
- Put the DVD you want to copy in the disc tray.
- Press VCR so the green VCR light appears on the front of the DVD/VCR.
- Turn on the TV.

- 1** Point the remote control at the DVD/VCR. Press **Number buttons 0, 0, 3**. "DISC" will appear on the TV screen.

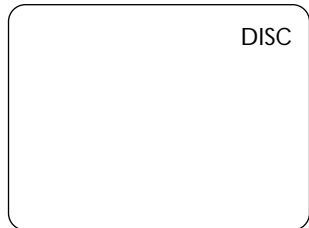

- 2** Press **SPEED** until the desired tape speed (**SP** or **SLP**) appears briefly on the screen. *Details about tape speed are on page 72.*
- 3** Press **REC** ● to start recording. The red REC light will appear on the front of the DVD/VCR.
- 4** Press **DVD**. Press **PLAY** ► to play the disc.
- 5** To pause the recording, press **VCR**, then press **PAUSE** ■■ once. The red REC light will flash. To resume recording, press **REC** ● or press **PAUSE** ■■ again. The red REC light will come on again.
- 6** To stop recording, press **VCR**, then press **STOP** ■.

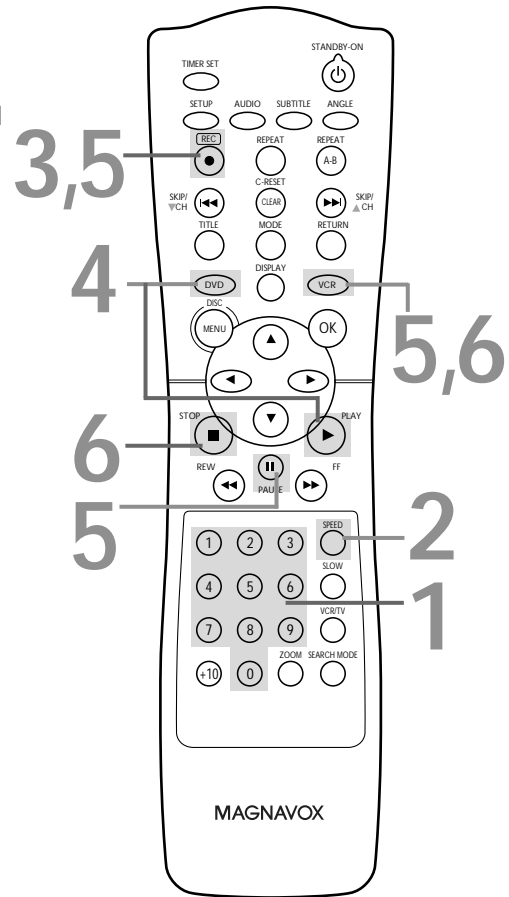

Helpful Hint

- A timer recording is not possible during DVD to videotape duplication.

40 Repeat Play

Follow the steps below to play a videotape repeatedly.

1 Press VCR, then press DISC/MENU.

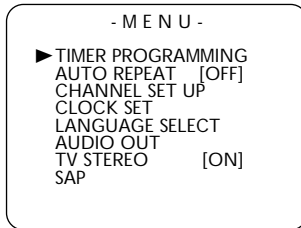

2 Press ▲ or ▼ to select AUTO REPEAT.

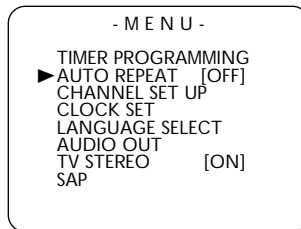

3 Press ► so ON appears next to AUTO REPEAT.

Tape playback will begin immediately. AUTO REPEAT ► will appear on the TV screen briefly.
(If you are fast forwarding or rewinding the tape, press C-RESET/CLEAR to remove the menu, then press PLAY ► to begin tape playback.)
The tape will play to the end, rewind, then play again. (TV programming will appear on the screen while the tape is rewinding.)

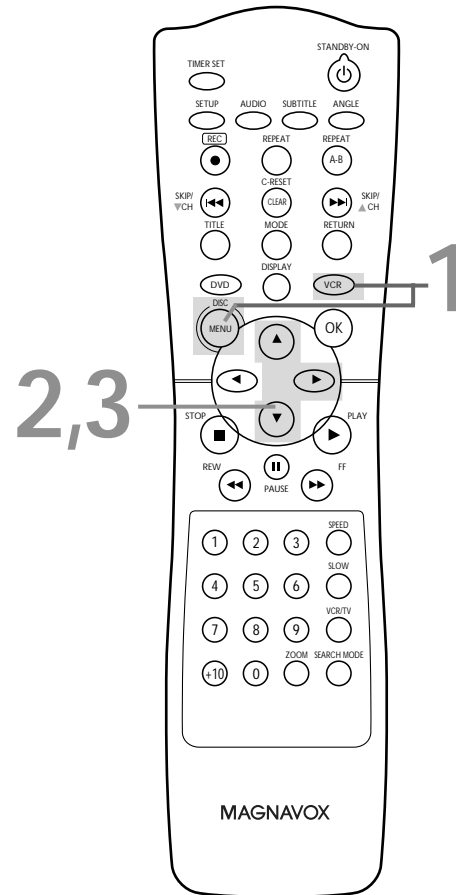
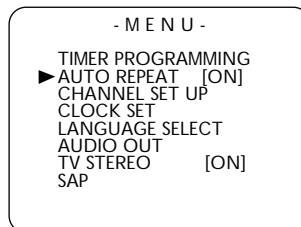

Helpful Hint

- To cancel AUTO REPEAT, follow steps 1-2. At step 3, press ► so OFF appears beside AUTO REPEAT. Press C-RESET/CLEAR.

Tape Counter 41

Follow the steps below to reset the VCR's real-time tape counter to zero at a tape location you want to refer to later.

1 Press **VCR**, then **play**, **fast forward**, or **rewind** a tape to the location that you would like to refer to later. Press **STOP** ■ to stop the tape.

2 Press **DISPLAY** to see the status display.

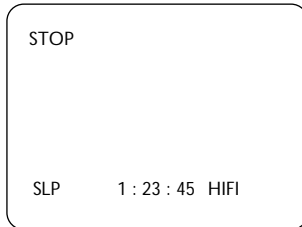

3 While the counter is on the screen, press **C-RESET/CLEAR** to reset the counter to zero.

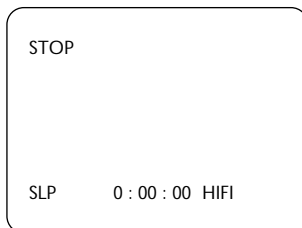

4 When you later want to return to this point on the tape, press **DISPLAY** so you can see the counter (while tape play is stopped). Press **REW** ◀◀ or **FF** ▶▶.

As the tape rewinds or forwards, watch the counter. When it reaches zero, press **PLAY** ▶ to play the tape.

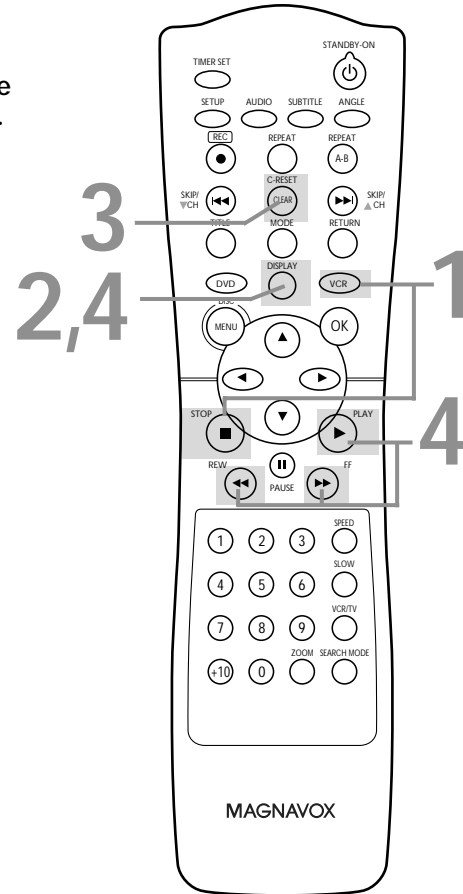

Helpful Hints

- You may only set the counter to zero at one location at a time. Setting the counter to zero at a second location will erase the previous zero setting.
- If you remove the tape, the counter will reset to zero at the point at which you last stopped playback whenever you reinsert the tape.

42 Time Search, Index Search

Time Search

Follow the steps below to search forward or backward on a tape a specific length of time. There must be a tape in the cassette compartment.

- 1 Press **VCR**, then press **SEARCH MODE** until the **TIME SEARCH** screen appears.



- 2 Within 30 seconds, press **▲** or **▼** until your desired length of time appears. Or, press and hold **▲** or **▼** until you reach the desired length of time. You can set a Time Search for up to 9 hours and 59 minutes (9:59).

- 3 Within 30 seconds, press **◀** (for a reverse search) or **▶** (for a forward search). The VCR begins rewinding or fast forwarding the tape. When the tape finishes rewinding or fast forwarding the time you specified, playback will begin. The time will count down beneath **TIME SEARCH** during the search. If the end of the tape is reached during the search, the search will stop and the tape may rewind. *Details are on page 44.*

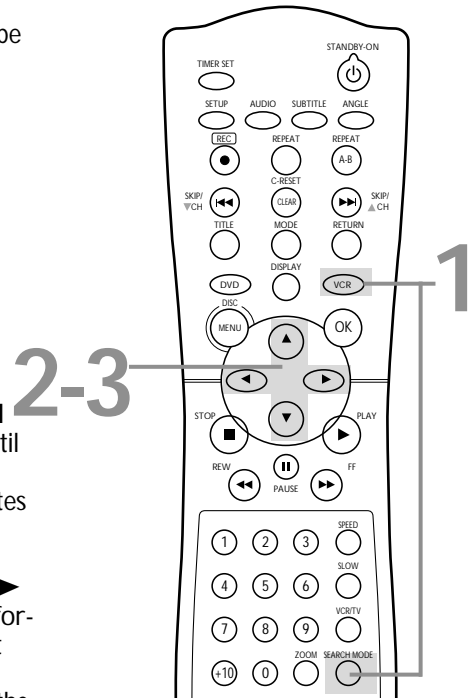

Index Search

An Index Mark is made automatically at the beginning of each recording. Essentially, an Index Mark is a "bookmark." Find the start of a recording by following these steps.

- 1 Press **VCR**, then press **SEARCH MODE** until the **INDEX SEARCH** screen appears.



- 2 Within 30 seconds, press **▲** or **▼** until the number of programs you want to skip appears beneath **INDEX SEARCH**. Include the current program in your number.
- 3 Within 30 seconds, press **◀** (for a reverse search) or **▶** (for a forward search). When the tape finishes rewinding or forwarding, playback will start. The program numbers will count down beneath **INDEX SEARCH** during the search. If the end of the tape is reached during the search, the search will stop and the tape may rewind. *Details are on page 44.* Recordings should be at least one minute long in SP speed, two minutes in LP, and three minutes in SLP. Otherwise, the Index Mark will not be available. *Details on tape recording speeds are on page 72.*

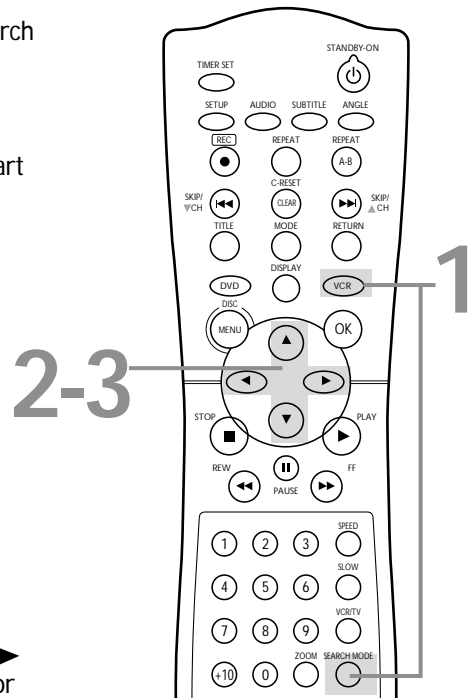

Helpful Hints

- Time Search and Index Search are not available during recording.
- To remove a Search display, press **C-RESET/CLEAR**.
- To cancel a search, press **STOP** ■.

- Before you begin, press VCR so the green VCR light appears on the front of the DVD/VCR.

Forward and Reverse Searching (SP/LP/SLP)

- 1 During tape playback, press and release **FF** ►► or **REW** ◄◄. A fast forward or reverse picture search will begin.
- 2 To return to playback, press **PLAY** ►.

Super High Speed Searching (LP/SLP)

- 1 During tape playback, press **FF** ►► or **REW** ◄◄, then press **again**. The search speed will increase. Repeatedly pressing **FF** ►► or **REW** ◄◄ will switch between regular and high speed searching.
- 2 To return to normal playback, press **PLAY** ►.

Viewing a Still Picture

- 1 During tape playback, press **PAUSE** ■■. A still picture will appear on the screen.
- 2 To advance the still picture one frame at a time, press **PAUSE** ■■ repeatedly.
- 3 To release the still picture and return to playback, press **PLAY** ►.

Viewing a Slow Motion Picture

- 1 During tape playback, press **SLOW**. The tape will play in slow motion.
- 2 To return to normal playback, press **PLAY** ►.

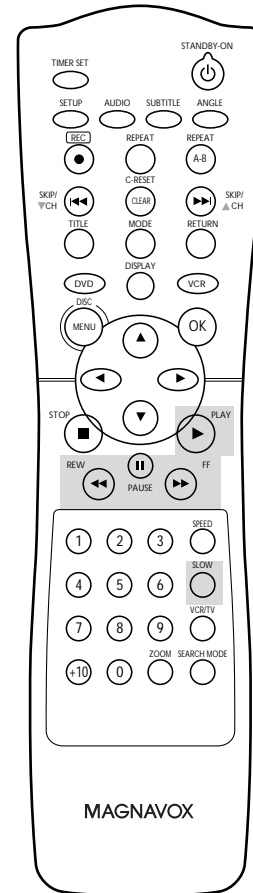

Helpful Hints

- Slow and Still modes will switch to Stop mode after five minutes to protect the DVD/VCR and the tape from damage.
- SP/LP/SLP means this feature will work with tapes recorded in Standard Play, Long Play, or Super Long Play. LP/SLP means this feature will work with tapes recorded in Long Play or Super Long Play. Tape speed details are on page 72.

44 Automatic Operation Features

The following tape features are available in VCR mode. Press VCR so the green VCR light is on, if necessary.

Automatic Playback

When you put a tape in the DVD/VCR, the power will come on. If the tape's record tab is missing, playback will begin.

If a timer recording is set and the TIMER REC light is flashing, the power will not come on automatically when you insert a tape with the record tab intact.

If a timer recording is set and the TIMER REC light is flashing, the DVD/VCR will eject the tape if the record tab is missing.

Automatic Rewind, Eject

When a tape is played, fast forwarded, or recorded to its end, the tape will rewind to the beginning, stop, and eject.

This feature does not operate if AUTO REPEAT is ON. *Details are on page 40.*

Tape Eject

A tape can be ejected with the DVD/VCR power on or off (but the DVD/VCR must be plugged in).

If a timer recording is set and the TIMER REC light is on, pressing STOP/EJECT ■▲ will turn on the DVD/VCR and/or cancel the timer recording. The TIMER REC light will turn off. Press STOP/EJECT ■▲ again to remove the tape. Remember to insert a tape and press TIMER SET to reset the timer recording.

Automatic Tracking Adjustment

The VCR adjusts tracking automatically to give you the best possible picture quality. With some recordings, however, you may get a better picture using manual tracking (see below).

Manual Tracking

To manually adjust the tracking during normal playback and slow motion playback of a videotape, press SKIP ►►/CH▲ or SKIP ◄◄/CH▼ on the remote.

Tracking will return to Automatic Tracking when you press STOP ■ or insert a tape.

Furthermore, you can press SKIP ►►/CH▲ or SKIP ◄◄/CH▼ to remove vertical jitter in a Still picture.

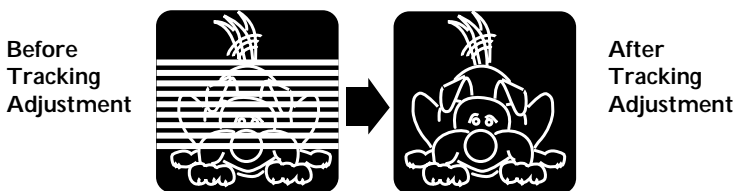

Multi-Channel Television Sound 45

Your DVD/VCR can play tapes recorded in Hi-Fi (high fidelity) stereo, which produces a crisp, clear sound from the left and right audio channels. Your DVD/VCR also can play tapes recorded in a second audio (usually, that means your program is recorded in a second language). Of course, your DVD/VCR will play tapes recorded in monaural (single-source) sound as well.

Your DVD/VCR also will record a video cassette in Hi-Fi stereo or in second audio, so when you play that tape on the DVD/VCR, it will be in stereo or second audio.

Read the directions on this page to familiarize yourself with the stereo and second audio setups. Then follow the directions on page 46 to record in stereo or second audio, or follow the directions on page 47 to play tapes recorded in Hi-Fi stereo.

Understanding Displays

When you watch TV channels through the DVD/VCR, portions of the display shown below will appear when you press DISPLAY twice.

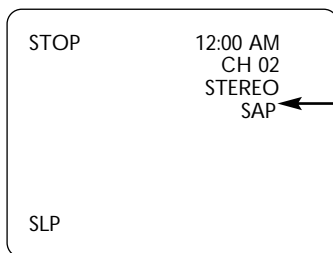

*If SAP or STEREO appears, the program is available in second audio or stereo. Even though a program is available in second audio or stereo, you must program the DVD/VCR to receive or record the program. Follow the directions on page 46.
This display is not available during tape playback.*

To play programs in stereo, connect the DVD/VCR to a Stereo or TV as described on pages 11 and 14. You will use the red and white AUDIO OUT jacks on the DVD/VCR.

46 Multi-Channel Television Sound (cont'd)

To set the DVD/VCR to receive programs in stereo or second audio, follow these steps.

1 Press VCR, then press DISC/MENU.

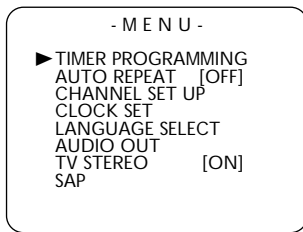

2 Press ▲ or ▼ to select TV STEREO or SAP (Second Audio Program). Press ▶ so ON appears beside your selection.

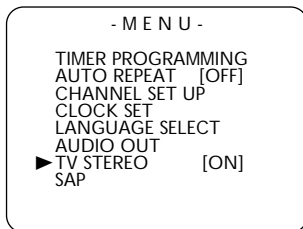

3 Press DISC/MENU to remove the menu.

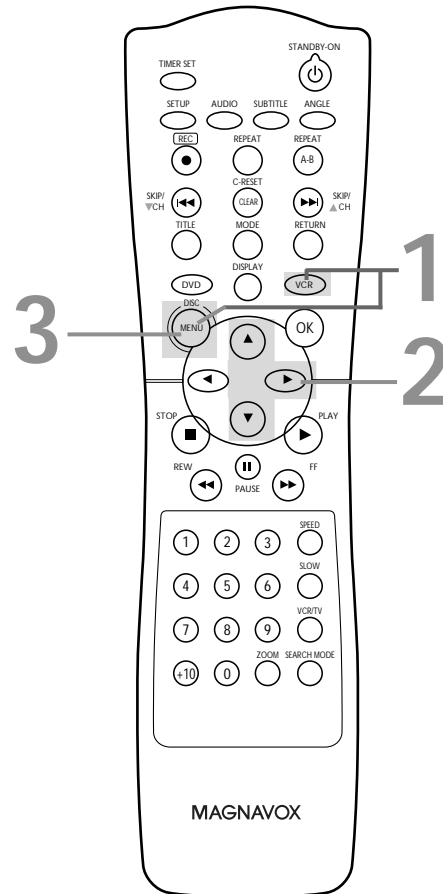

Helpful Hints

- You can only receive and record in stereo or second audio programs that are broadcast in stereo or second audio. You can only play in stereo or second audio tapes that were recorded in stereo or second audio. Please see page 45 to determine if the program is in stereo or second audio.
- If SAP is ON but the program is not broadcast in Second Audio, you will hear and record the program in normal audio.

Multi-Channel Television Sound system broadcasts are recorded in Hi-Fi stereo. To play in Hi-Fi stereo the tapes recorded in Hi-Fi stereo, follow these steps.

1 Press VCR, then press DISC/MENU.

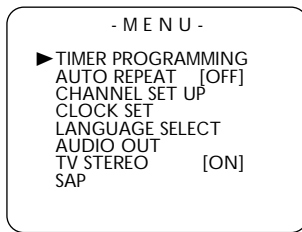

2 Press ▲ or ▼ to select AUDIO OUT. Then, press ►.

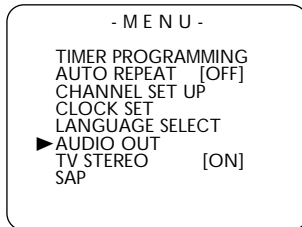

3 Press ▲ or ▼ to select HIFI. ON will appear beside HIFI.

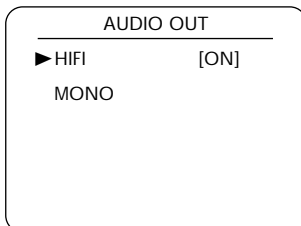

4 Press DISC/MENU to remove the menu.

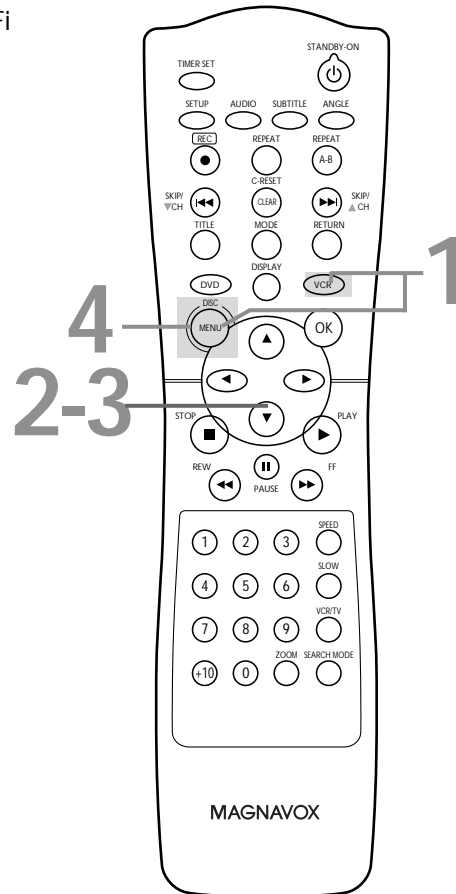

Helpful Hints

- Programs are recorded in both Hi-Fi stereo sound and in monaural sound.
 - The audio level of a tape recorded in Hi-Fi stereo will differ from the audio level of a tape not recorded in Hi-Fi stereo.
 - You can change to MONO if you want monaural audio playback. Follow steps 1-2, then press ▲ or ▼ to select MONO. Press DISC/MENU. HIFI will disappear from the status display.
 - If you play non-Hi-Fi tapes while AUDIO OUT is set to HIFI, HIFI will not appear on the status display. The tape will play in monaural sound.
- Please see additional notes on page 77.**

48 DVD Disc Menus

DVDs contain menus that describe the contents of the DVD or allow you to customize DVD playback. For example, the menu may offer choices for subtitle languages, special features, or scene selection. To use the DVD Disc menu and select playback features, follow these steps.

- 1** Press **DVD** to put the DVD/VCR in DVD mode.
- 2** Press **DISC/MENU**. The DVD's main Disc menu will appear.
- 3** Press **▲**, **▼**, **◀**, or **▶** to select an item, then press **OK**. Continue this process to set up all the features you want.

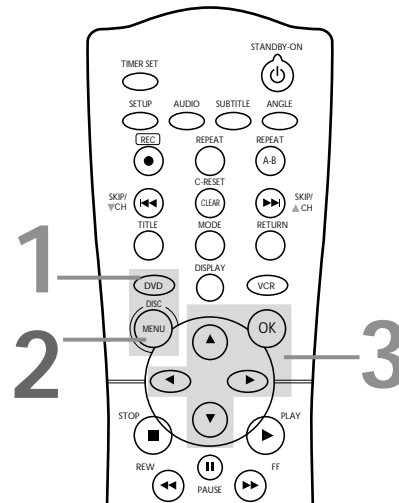

Using the Title Menu

Some DVDs have a Title Menu, which lists the Titles available on the DVD. Use the Title Menu to start playback at a specific Title.

- 1** Press **DVD**.
- 2** Press **TITLE**. The Title menu will appear. If a Title menu is not available, the "X" may appear on the TV screen. Or, if the DVD only has a main Disc menu as described above, it may appear when you press TITLE.
- 3** Press **▲**, **▼**, **◀**, or **▶** to select a Title, then press **OK**. Playback will begin at the Title you selected.

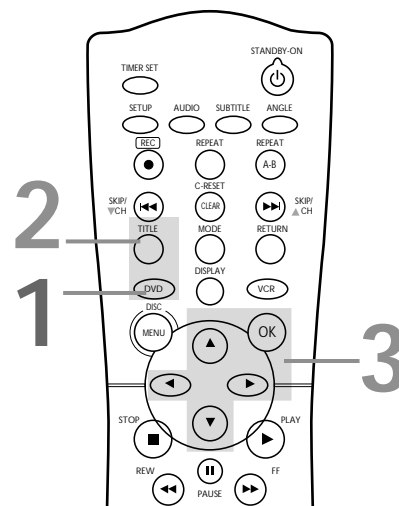

Helpful Hints

- Menus vary among DVDs. Follow the information accompanying the DVD.
- Not all DVDs have Title menus.
- Some DVDs may refer to Chapters as "scenes." Some DVDs may refer to the Title Menu as the "scene index."
- The TITLE button will not be active with all DVDs.

Fast Forward/Reverse Search 49

1 Press **DVD** to put the DVD/VCR in DVD mode. The red DVD light will appear on the front of the DVD/VCR.

2 During playback, press **FF** ►► or **REW** ◀◀. Use **FF** ►► for a forward search. Press **REW** ◀◀ for a reverse search.

- During DVD playback, pressing **FF** ►► or **REW** ◀◀ will forward or reverse the picture at two, eight, 50, or 100 times the normal playback speed. An ◀◀ 2, ◀◀ 8, ◀◀ 50, or ◀◀ 100 will appear briefly on the TV screen to indicate reverse searching. Or, ►► 2, ►► 8, ►► 50, or ►► 100 will appear briefly on the TV screen to indicate fast forward searching. Sound will be muted during searching.
- During Audio CD playback, you may search only at 16 times the normal playback speed. An ◀◀ 16 or ►► 16 will appear briefly on the TV screen. Sound will be intermittent during searching on an Audio CD.
- During MP3 playback, you can search at only eight times the normal speed. An ◀◀ 8 or ►► 8 will appear briefly on the TV.



Example: Playing a DVD in reverse at twice the normal playing speed.

3 Press **PLAY** ► to return to normal playback.

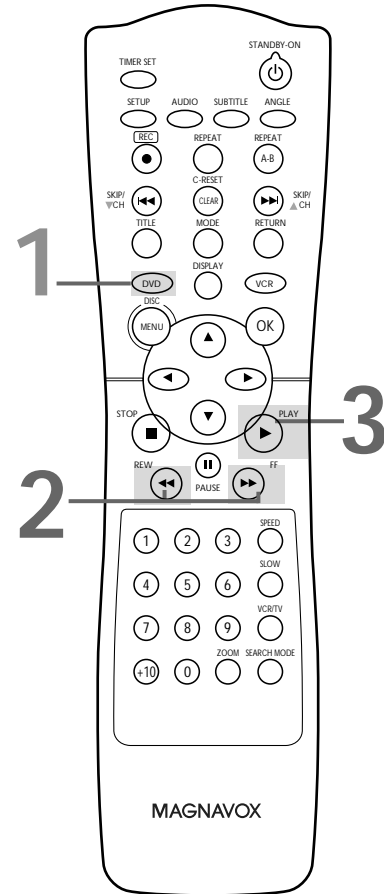

50 Title/Chapter Playback, Specific Time Playback

Specific Title/Chapter Playback

- 1 With a DVD in the DVD/VCR, press **DVD**.
- 2 During DVD playback, press **SEARCH MODE** until CH (for Chapter) or TT (for Title) appears on the TV screen. The number of available Titles or Chapters will appear at the right (/4, for example).
- 3 Enter the Title or Chapter number using the **Number buttons**. The selected Title or Chapter will start to play.

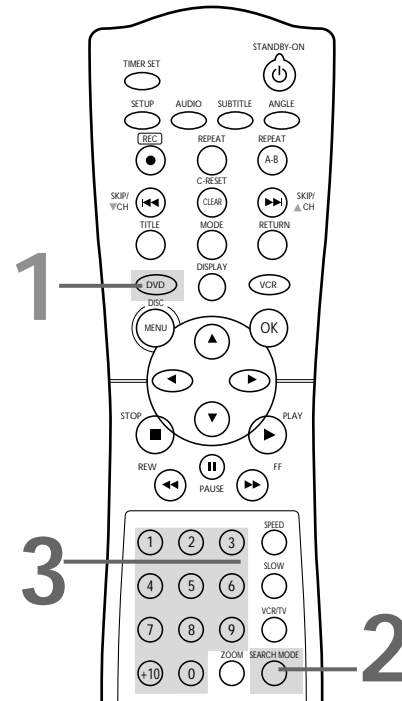
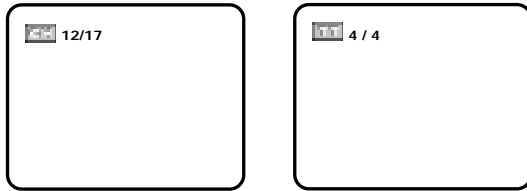

Specific Time Playback

- 1 Press **DVD** to put the DVD/VCR in DVD mode.
- 2 During DVD or Audio CD playback, press **SEARCH MODE** until the Time Search display appears.

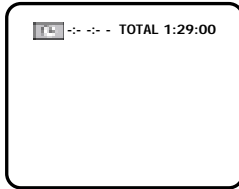

- 3 Within 30 seconds, use the **Number buttons** to enter the elapsed playing time (of the Track or Title) at which you want playback to begin. Enter the time in hours, minutes, and seconds. Within a few seconds, playback will start at the specified time.
 - Example: 1 hour, 23 minutes, and 30 seconds
1 → 2 → 3 → 0
 - Make sure the time you enter is within the total time of the current Title or Track. If it is not, the time space will clear and playback will continue at its current point. The total time available in the current Track or Title will appear in the Time Search display.
 - If you make a mistake entering the time, press C-RESET/CLEAR to clear the time area. Enter the correct information.

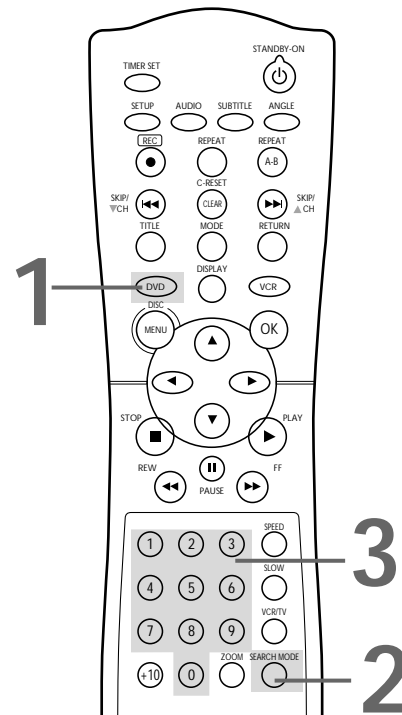

Helpful Hint

- Title/Chapter playback is not available with some DVDs.

Track Playback 51

There are three ways to begin playback on an Audio CD at a specific Track: Use the Number buttons, the SEARCH MODE button, or SKIP ►►/CH▲ and SKIP ◀◀/CH▼.

- Before you begin, press DVD so the red DVD light appears on the front of the DVD/VCR.

A

Using the Number Buttons

Press the Number buttons to enter a Track number.

Playback will start at the selected Track.

For single-digit Tracks (1-9), press a single Number button.

For Tracks 10 and above, press the +10 button so the Search display (TR - -) appears on the TV. Press the Number button of the first digit, then press the Number button of the second digit.

For example, to play Track 26, press +10, then Number 2, then Number 6.

If you enter a Track number that is not available on the Disc, playback will not begin (or the current Track will continue to play).

B

Using SEARCH MODE

Press SEARCH MODE so the Track Search display (TR) appears. Within 30 seconds, press the Number buttons to select the Track number. Playback will begin at the selected Track. For a single-digit Track (1-9), enter a zero first. For example, to play Track 5, press 0, 5. You do not have to use the +10 button in Search Mode.

C

Using SKIP ►►/CH▲ or SKIP ◀◀/CH▼

During playback, press SKIP ►►/CH▲ to skip the current Track and move to the next Track. The Track number will appear briefly on the DVD/VCR display panel.

During playback, press SKIP ◀◀/CH▼ to return to the beginning of the current Track or press repeatedly to go to previous Tracks. The Track number will appear briefly on the DVD/VCR display panel.

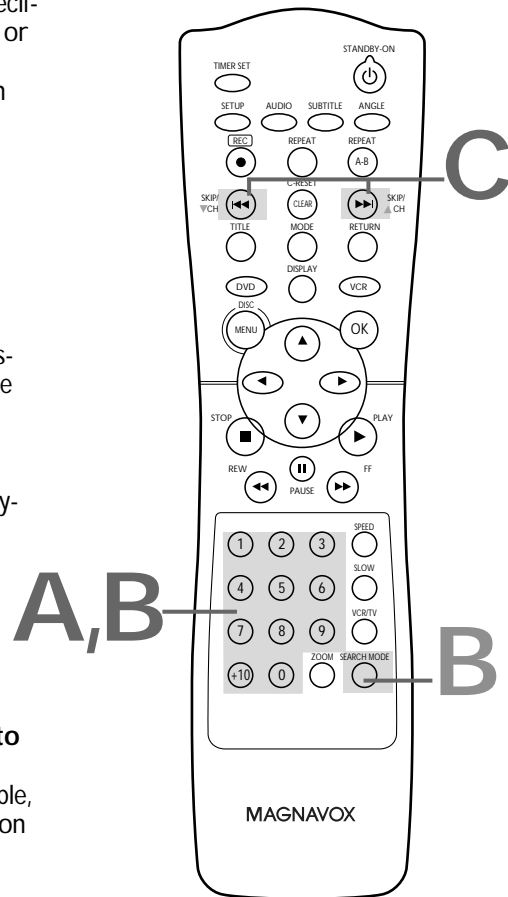

Helpful Hint

- You cannot use SKIP ►►/CH▲ to go from the last Track on the Disc to the first Track.

52 Paused and Step-by-Step Playback, Resume

Paused and Step-by-Step Playback

- 1 Press DVD.
- 2 During DVD or Audio CD playback, press PAUSE ■■. Play will pause and the sound will be muted.
- 3 When playing a DVD, press PAUSE ■■ repeatedly to see the picture advance one frame (or step) at a time. The sound will remain mute. Pressing PAUSE ■■ repeatedly during Audio CD, MP3, or JPEG playback will have no effect.
- 4 Press PLAY ► to resume playback.

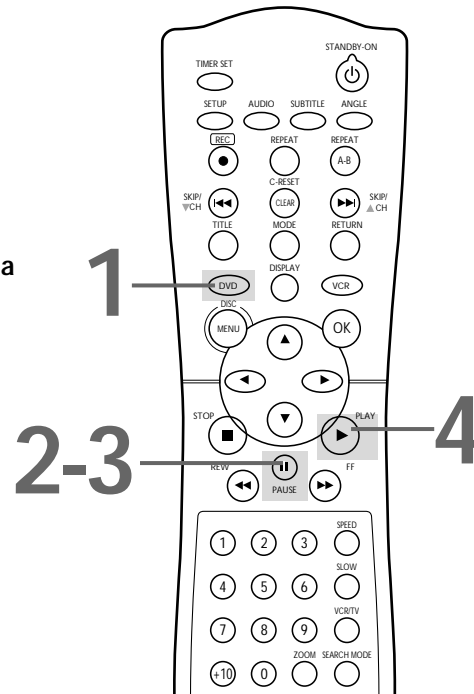

Resume

- 1 Press DVD.
- 2 Press STOP ■ during DVD or Audio CD playback. In a few seconds, the following Resume message will appear on the TV screen. (The file list will appear during MP3 or JPEG playback.)

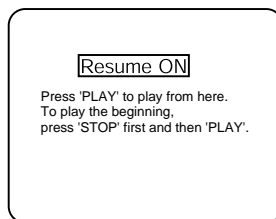

- 3 Press PLAY ►. In a few seconds, play will resume from the point at which it stopped last. You can resume play at the same point even if you turn off the DVD/VCR, then turn it on again later. However, opening the disc tray will cancel the Resume feature. Play will start at the beginning the next time you insert the Disc. To cancel Resume and start playing the Disc from the beginning, press STOP ■ a second time while playback is stopped. The Stop symbol (■) will appear briefly on the TV screen. Press PLAY ► to start playing the Disc from the beginning.

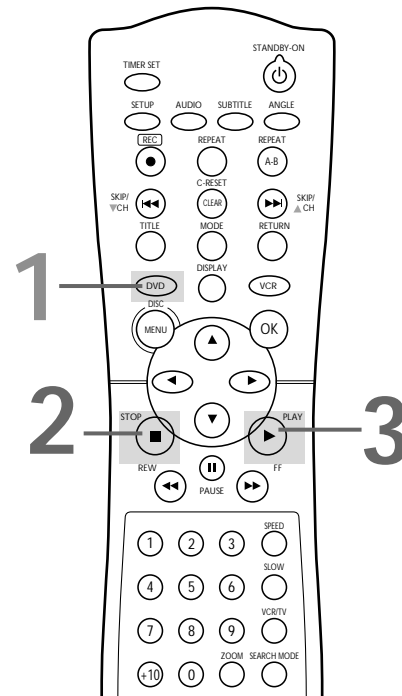

Repeat

- 1 Press DVD to put the DVD/VCR in DVD mode.
- 2 During DVD or Audio CD playback, press REPEAT until the repeat mode you want appears on the TV. On a DVD, select CHAPTER, TITLE, or OFF. On an Audio CD, select TRACK, ALL (all Tracks on the Disc), or OFF. Selecting a new Track, Chapter, or Title will cancel repeat playback.



Example: Repeat a DVD Chapter



Example: Repeat an Audio CD Track

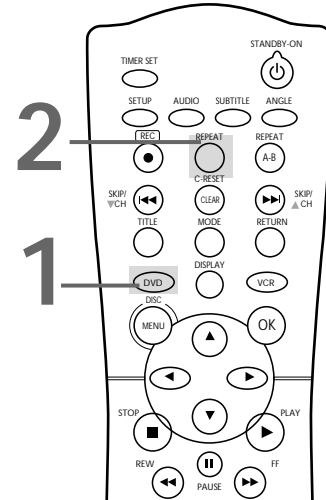

A-B Repeat

Follow these steps to play a section of a DVD or Audio CD repeatedly.

- 1 Press DVD.
- 2 Press PLAY ► to play the Disc to the point at which you want repeated playback to begin.
- 3 Press A-B REPEAT to set the starting point (A). A - will appear on the TV screen.
- 4 Play or fast forward the Disc to the point at which you want repeated playback to end, then press A-B REPEAT again. A-B will appear on the TV. The section will begin to play repeatedly.
- 5 To cancel A-B Repeat, press A-B REPEAT. OFF will appear on the TV screen. Regular playback will resume.

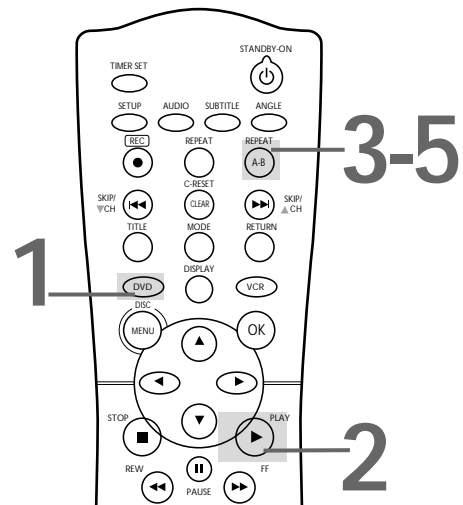

Helpful Hints

- Repeat playback and A-B Repeat are not available with all Discs.
- The entire A-B Repeat section must be within a single Title or Track. If you do not enter Point B before the end of the Track or Title is reached, the end of the Track or Title will become Point B automatically.
- Point B must be later on the Disc than Point A.

54 Markers

Use Markers to remember your favorite places on an Audio CD or DVD. To set the Markers, follow these steps.

- Before you begin, place the DVD/VCR in DVD mode. Press DVD so the red DVD light appears on the front of the DVD/VCR.

- 1** Play the Disc to within 30 seconds prior to the point at which you want to set the Marker. **During playback, press SEARCH MODE until the Markers appear at the top of the TV screen.**

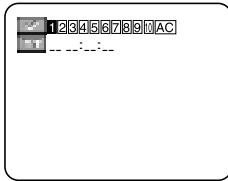

- 2** Within 30 seconds, press ◀ or ▶ to select a Marker (1-10). Make sure _ : _ : _ appears beneath the number.

- 3** Let the Disc play to the point at which you want to set the Marker (up to 30 seconds away). When the Disc reaches the point you want to remember, press OK. The Title number and elapsed playing time (DVD) or Track number and its elapsed playing time (Audio CD) will appear.

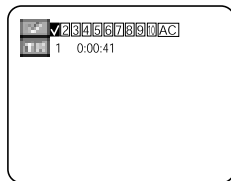
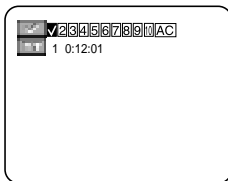

- 4** To return to a Marker during playback, press SEARCH MODE until you see the Markers. Press ◀ or ▶ to choose the Marker you want, then press OK. Disc play will continue from the marked point.

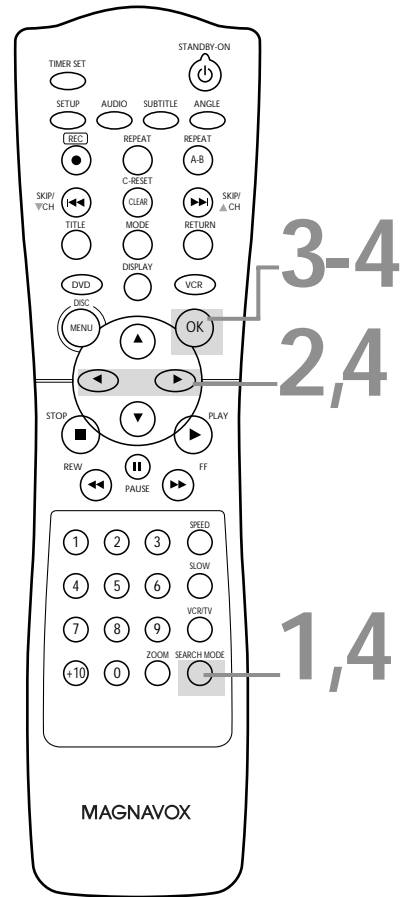

Helpful Hints

- Opening the disc tray or turning off the DVD/VCR will erase all the Markers.
- To erase a single Marker, press SEARCH MODE until you see the Markers. Press ◀ or ▶ to select a Marker. Press C-RESET/CLEAR. Press RETURN or SEARCH MODE to remove the display.
- To erase all the Markers, press SEARCH MODE until you see the Markers. Press ▶ to select AC, then press OK. Press SEARCH MODE or RETURN to remove the display.

Subtitles

You can select a language for DVD subtitles during playback. You can select only languages that are available on the DVD.

- 1 Press DVD.
- 2 During playback, press SUBTITLE to select a subtitle language. The number of available languages appears at the right of the subtitle display. In the example below, six languages are available (/6). After a few seconds, the subtitles will appear. Or, press SUBTITLE to turn off subtitles.



Example: English as first of six available subtitles

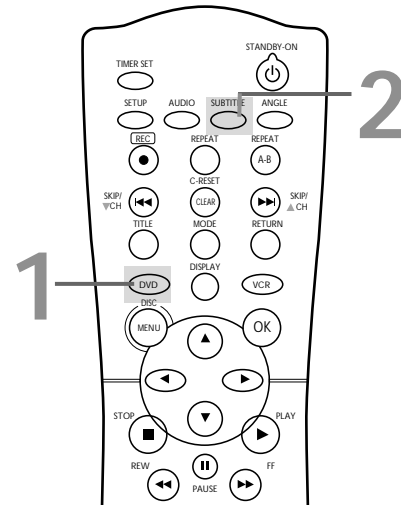

Camera Angles

Some DVDs contain scenes recorded from different angles. The camera angle will not change if the DVD does not contain sequences recorded from different camera angles.

- 1 Press DVD.
- 2 During playback, press ANGLE to select a different angle. The number of available angles appears at the right of the Angle display. In this example, eight angles are available (/8).

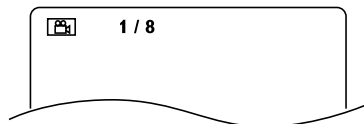

Example: Angle 1 of eight available angles

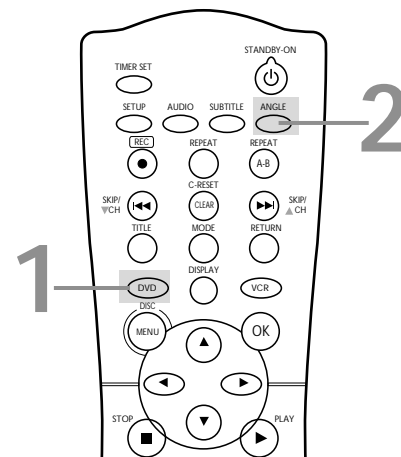

Helpful Hints

- On some DVDs, you must select a subtitle language in the Disc menu.
- If the language does not appear after pressing SUBTITLE several times, the Disc does not have subtitles in that language.
- Opening the disc tray will cancel your subtitle setting.
- If the current portion of the Disc has multiple camera angles,  will appear on the TV screen. ANGLE ICON must be ON. Details are on pages 64-65.

56 Parental Controls Password

Parental Controls prevents viewing of DVDs that exceed your rating limits. This feature will not limit viewing if the DVD is not rated or coded. Check your DVDs and settings before letting children access the DVD/VCR. Follow these steps to change your password.

1 Press **DVD** to put the DVD/VCR in DVD mode. The red DVD light will be on. Press **STOP** to stop Disc playback.

2 Press **SETUP**.

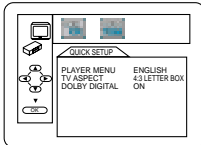

3 Press **▶** to select **CUSTOM**, then press **OK**.

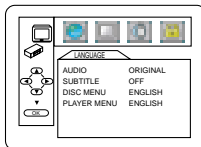

4 Press **▶** to select **🔒** (the lock), then press **OK**. The first time you set a password, this menu will appear.

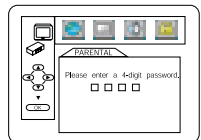

Press the **Number** buttons to enter a **four-digit password**. The password will appear on the screen. Write it down so you don't forget it. Press **OK**. You are finished! Go to step 7.

If you have set a password before, this menu will appear.

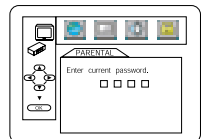

Press the **Number** buttons to enter your **current four-digit password**. Asterisks (*) will appear instead of your password. This protects its identity.

5 Press **▼** to select **CHANGE**, then press **OK**.

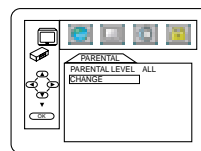

6 Press the **Number** buttons to enter a **four-digit password**. The password numbers will appear on the screen. Write down the password so you will not forget it. Press **OK**. The previous menu will reappear.

7 Press **SETUP** to remove the menu.

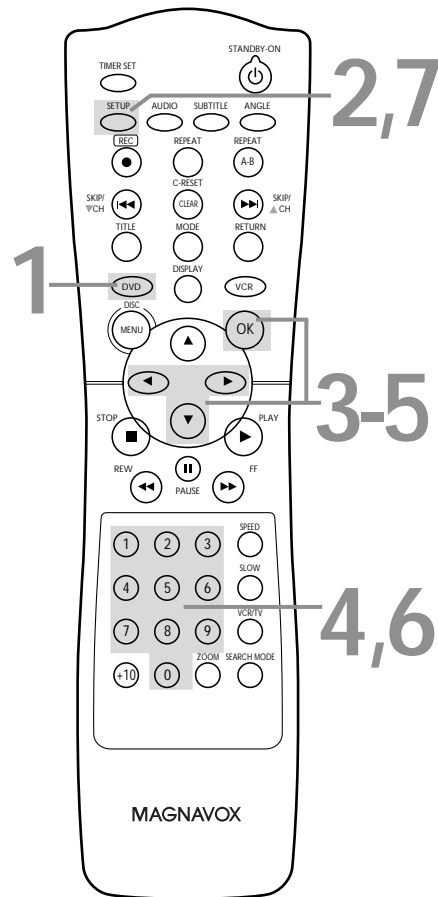

Helpful Hints

- The default password is 4737. If you forget your password, press Number buttons 4, 7, 3, 7 at step 4. You will be prompted to enter a new four-digit password. Use the Number buttons to enter a new four-digit password, then press OK. PARENTAL LEVEL will reset to ALL. See page 57 to reset PARENTAL LEVEL as you desire.
- A power failure will not erase your password.

Parental Levels 57

Follow these steps to set the rating level for your DVDs. DVDs whose ratings exceed the level you set will not play.

1 Press **DVD** to put the DVD/VCR in DVD mode. The red DVD light will be on. Press **STOP** to stop Disc playback if necessary.

2 Press **SETUP**.

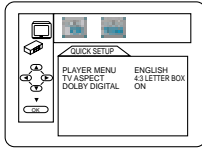

3 Press **▶** to select **CUSTOM**, then press **OK**.

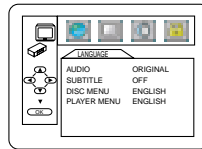

4 Press **▶** to select **8** (the lock), then press **OK**.

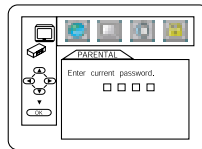

5 Press the **Number** buttons to enter your four-digit password.

6 Press **▲** or **▼** to select **PARENTAL LEVEL**, then press **OK**.

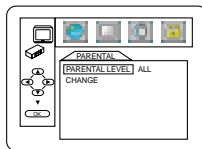

7 Press **▲** or **▼** to select a level, then press **OK**. The rating levels continue on two menu screens. Press **▲** or **▼** repeatedly to move to the next or previous screen to find the rating level you want.

After making your selection, the previous menu will appear. The level you selected will appear beside **PARENTAL LEVEL**.

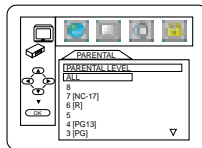

8 Press **SETUP** to remove the menu.

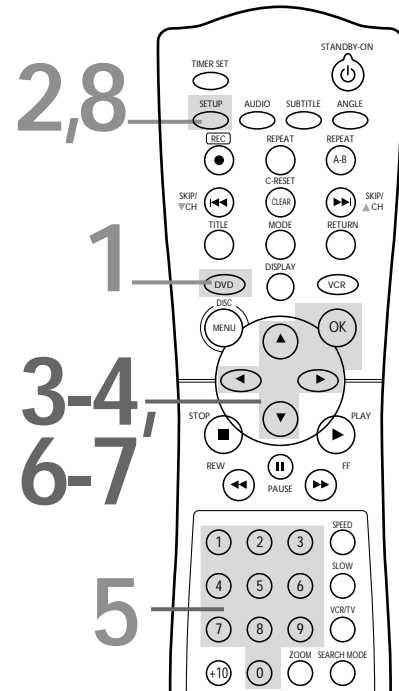

RATING EXPLANATIONS

- ALL - Parental Controls is inactive; all discs can play.
- 8 - Adult material
- 7 - NC-17 - Not appropriate for children under 17
- 6 - R - Restricted; parental approval required for viewers under 18.
- 4 - PG13 - Unsuitable for children under 13
- 3 - PG - Parental Guidance suggested.
- 1 - G - General Audience; recommended for all ages.

Helpful Hints

- When you try to play a DVD whose rating exceeds the level you set, an on-screen message will indicate the DVD cannot play. Remove the DVD, then set **PARENTAL LEVEL** to **ALL**. Reload the DVD and begin playback. Some DVDs may let you enter your four-digit password to begin playback. Follow the on-screen messages as prompted.
- You cannot use the default password (4737) to play a DVD.

58 Audio Language, Stereo Sound Mode

Audio Language

You can select a language for DVDs during playback if multiple languages are available.

- 1 Press DVD to put the DVD/VCR in DVD mode if necessary. The red DVD light will be on.
- 2 During DVD playback, press AUDIO repeatedly to choose one of the available languages. The new audio will be heard. The display will disappear after about five seconds.
The Audio display may show if the DVD has Dolby Digital or multi-channel (5.1 CH) sound or its sampling rate (48 k, for example). The number of available languages appears after the " / " at the right of the display (/ 3, for example).

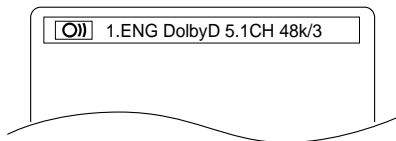

Example: English audio

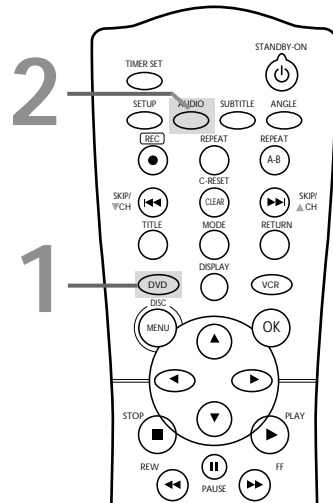

Stereo Sound Mode

If you connected the DVD/VCR to a Stereo or TV using the COAXIAL DIGITAL AUDIO OUT jack as described on page 15, you cannot adjust Stereo Sound Mode. Otherwise, adjust Stereo Sound to determine whether you will hear the left channel, the right channel, or both channels (stereo) during Audio CD playback.

- 1 Press AUDIO during Audio CD playback to choose STEREO, L-CH, or R-CH.

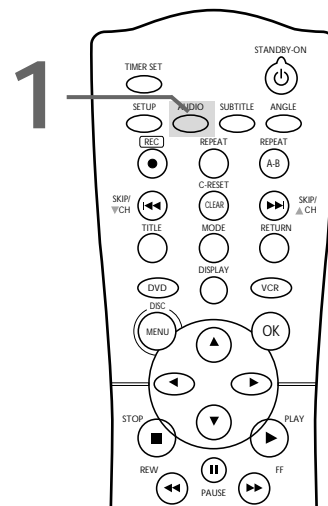
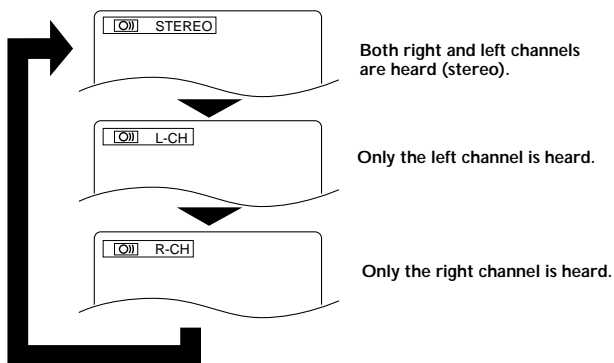

Helpful Hints

- If a language is not available after pressing AUDIO several times, the DVD does not have that language.
- Some DVDs only let you change the language in the Disc menu.
- Audio languages may be abbreviated (such as ENG for English). Or, three dashes (- - -) may appear instead of an abbreviation.
- You cannot adjust the Stereo Sound Mode when Virtual Surround is active. Details are on page 70.

Slow Motion

- 1 Press **PAUSE** **||** during DVD playback.
- 2 Press **FF** **▶▶** or **REW** **◀◀**. Slow motion playback will begin. Press **FF** **▶▶** or **REW** **◀◀** repeatedly during slow motion playback to play the DVD forward or backward at 1/16, 1/8, or 1/2 the normal speed.



Example: Playing a DVD forward at half the normal speed.

- 3 Press **PLAY** **▶** to return to normal playback.

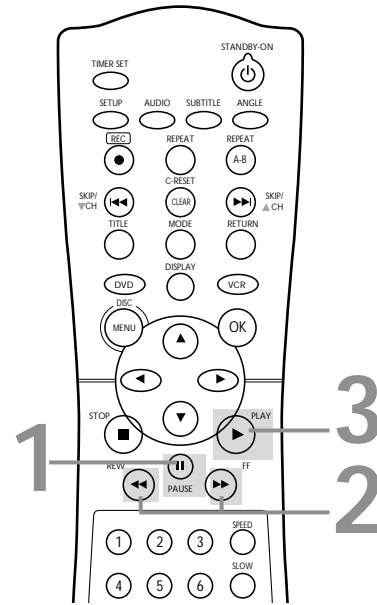

Zoom

You can enlarge the DVD picture to two or four times larger than normal.

- 1 Press **ZOOM** during playback or when play is paused. The picture will appear twice as large. Press **ZOOM** again to make the picture four times as large as normal. Either x2 or x4 will appear beside the zoom icon on the TV screen.
- 2 While the picture is enlarged, press **▲**, **▼**, **◀**, or **▶** to move the zoomed image up, down, left, or right. The gray box with an inner blue box that shows during Zoomed playback is the position guide. To remove it or show it, press **OK**. The position of the blue box inside the gray box indicates the position of the zoomed image within the overall picture.



- 3 To return the picture to normal, press **ZOOM**.

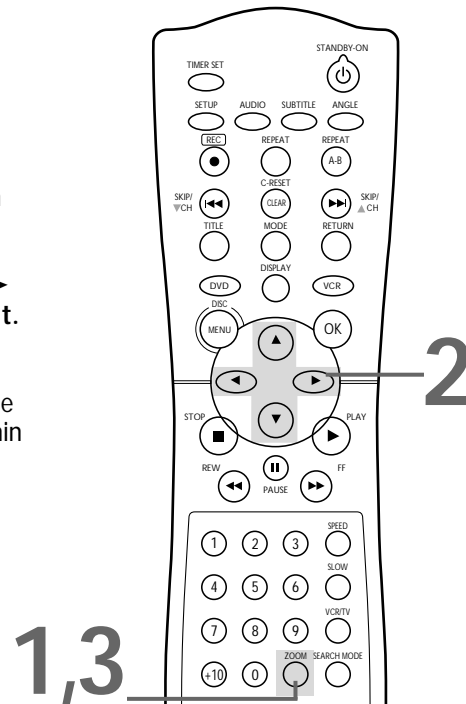

Helpful Hints

- The sound will be mute during slow motion playback.
- The **SLOW** button on the remote does not activate slow motion of DVDs.
- The x4 zooming is not active with some Discs. Only x2 zooming is available for JPEGs.

60 Programmed Playback

You may determine the order in which Audio CD Tracks will play. You also can program MP3 or JPEG files to play in a special order. To set a Program, follow these steps.

- 1 Press DVD.
- 2 While playback is stopped, press MODE. The PROGRAM screen will appear.

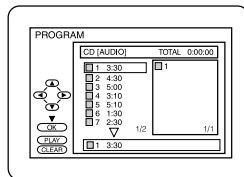

Audio CD example

- 3 Press **▲** or **▼** to select a track you want to play, then press **OK**. Press C-RESET/CLEAR to erase the last Track in the Program if you make an error. Repeat this step until you have selected all the Tracks you wish to play in the Program.
- 4 Press **PLAY ▶**. The Tracks will play once in the order you set. Turning off the DVD/VCR or opening the disc tray will erase the Program.

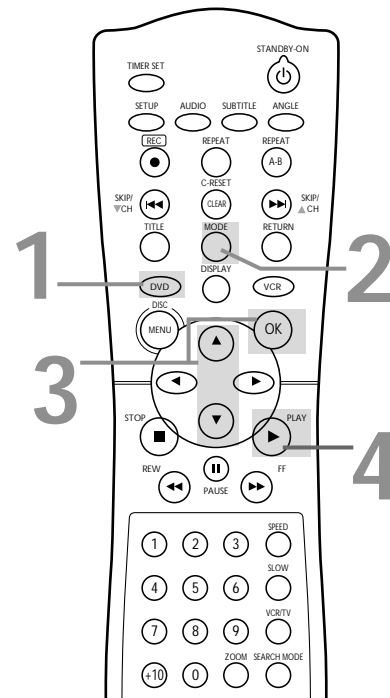

Helpful Hints

- You cannot use the Number buttons or SEARCH MODE to select another Track while playing a Program. Use SKIP **▶▶**/CH**▲** or SKIP **◀◀**/CH**▼** to select other Tracks within the Program.
- You cannot combine random playback with programmed playback.
- You may play a Program or a Track within a Program repeatedly. During programmed playback, press REPEAT so ALL (all Tracks in the Program) or TRACK appears. The entire Program or the current Track will play over and over.
- You cannot alter a Program during playback.
- You can start Program play only while in the PROGRAM screen.
- A Program can have a maximum of 99 Tracks.

Random Playback 61

You may play the Tracks of an Audio CD in Random order instead of the order in which they are recorded (1,2,3...). You can also use this feature for JPEG and MP3 files.

- 1** Press **DVD** to put the DVD/VCR in DVD mode. The red DVD light will appear.
- 2** While playback is stopped, press **MODE** twice so the **RANDOM** screen appears.

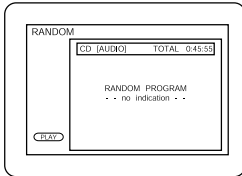

Example: Audio CD

- 3** While the **RANDOM** screen appears, press **PLAY** ►. The Tracks will play in random order. After all the Tracks have played once, playback will stop.

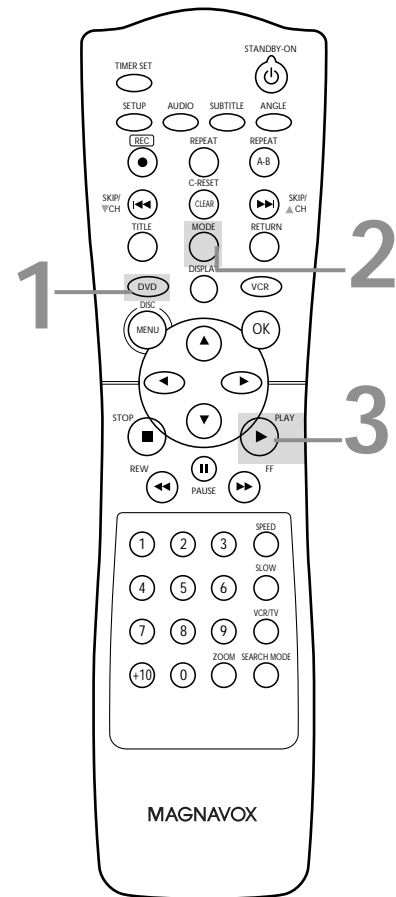

62 MP3/JPEG Playback

The DVD Player will play MP3 or JPEG files that you record and finalize on a CD-RW (Compact Disc-Rewritable) or CD-R (Compact Disc-Recordable).

These Discs may contain pictures in a JPEG format or audio Tracks in an MP3 format. For example, you may have photographic film developed by a retailer that places the pictures on a CD-R for you. These pictures may be in JPEG format.

Or, you may copy or download MP3 music files from certain legal Internet sites, then copy those files onto a CD-R or CD-RW. You cannot make or record such Discs using this DVD/VCR. See your computer manual for details on recording.

Keep these characteristics in mind when making Discs you intend to play on the DVD Player of this DVD/VCR.

- Record MP3 Tracks at a sampling frequency of 44.1 kHz or 48 kHz. Use a bit rate between 112 kbps and 320 kbps.
- When recording JPEG Files, the size of the picture should be between 32 x 32 and 6300 x 5100 dots.

- 1** Press **DVD** to put the DVD/VCR in DVD mode.
- 2** When you put a CD-RW or CD-R with MP3 or JPEG files in the DVD/VCR, the File List will appear on the TV screen. To see the File List during playback, press **SEARCH MODE**. The current Track will be highlighted. Press **▲** or **▼** to select a **Folder, MP3 Track, or JPEG File**.
- 3** If you choose a **Track or File**, press **PLAY ►** or **OK**. Starting with the Track or File you selected, the Tracks/Files will play in the order they were recorded, i.e. 1, 2, 3,
If you select a **Folder and press OK**, the **Tracks or Files within that Folder will appear**. Press **▲** or **▼** to select the **Track or File** you want, then press **PLAY ►** or **OK**.
 - Choose **FIRST PLAY** to start play from the first individual File or Track listed.
 - Press **TITLE** to return to the first item on the first MP3 or JPEG screen. You also can press **◀** to return to previous screens.
 - During JPEG playback, press **MODE** to choose a transition mode. For example, you can choose **Cut in/Cut off** or **Fade in/Fade out**. Press **MODE** again to remove the transition modes.
- 4** To stop playback, press **STOP ■**.

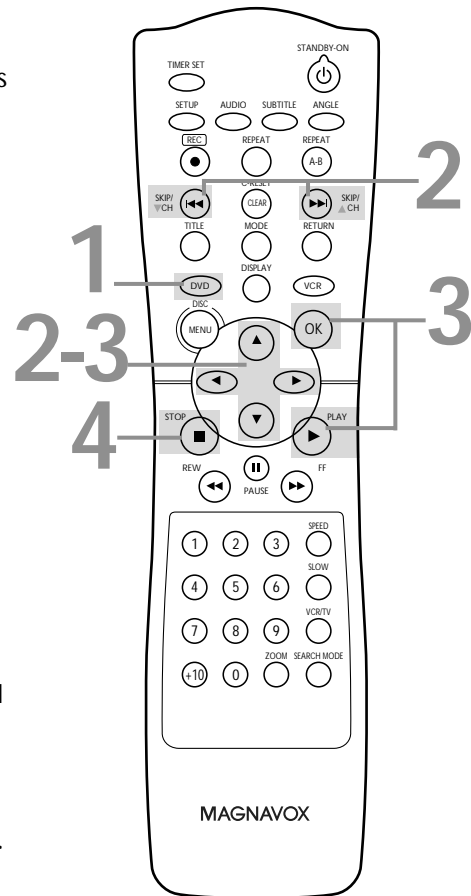

Helpful Hints

- JPEG images and MP3 Tracks are known as Files. Groups of Files are called Folders.
- JPEG Files have the ☺ icon.
- A maximum of 255 Folders can be recognized. A maximum of 256 Files can be recognized.
- MP3 Files have the 🎵 icon.
- During playback, press the Number buttons to select another Track. Or, press **SKIP ►►/CH▲** or **SKIP ◀◀/CH▼** to change Tracks.
- If a Track is not available, "X" will appear on the TV screen. Play may resume at an incorrect Track or may continue with its current Track.
- Specific Time playback is not possible with MP3 Tracks.

You can review MP3 and JPEG Track (File) information during playback.

- Before you begin, place the DVD/VCR in DVD mode. Press DVD so the red DVD light appears on the front of the DVD/VCR.

- 1 Press DISPLAY during playback.** The current Track name will show on the TV screen.
- 2 Press DISPLAY again.** The current Track number, total Tracks available, and elapsed playing time of the current Track will appear.

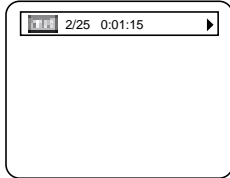

Or, the following may appear to indicate Repeat play.

- TRACK: The current Track will play repeatedly.
- GROUP: Tracks in the current Folder will play repeatedly.
- ALL: All Tracks will play repeatedly.

- 3 Press DISPLAY again to remove the display.**

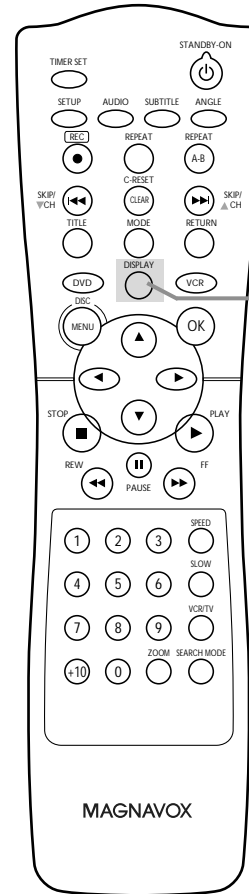

64 Display

You can change the TV Aspect, Angle Icon, and Automatic Power Off features of the DVD Player in the Display menu.

1 Press **DVD** to put the DVD/VCR in DVD mode.

2 When playback is stopped, press **SETUP**. The QUICK SETUP screen will appear.

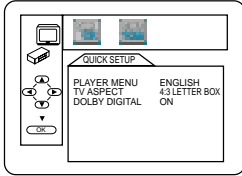

3 Press **▶** to select **CUSTOM** at the top of the menu, then press **OK**.

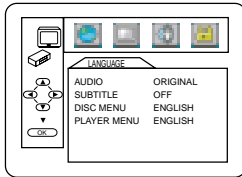

4 Press **◀** or **▶** to select **■** (display), then press **OK**.

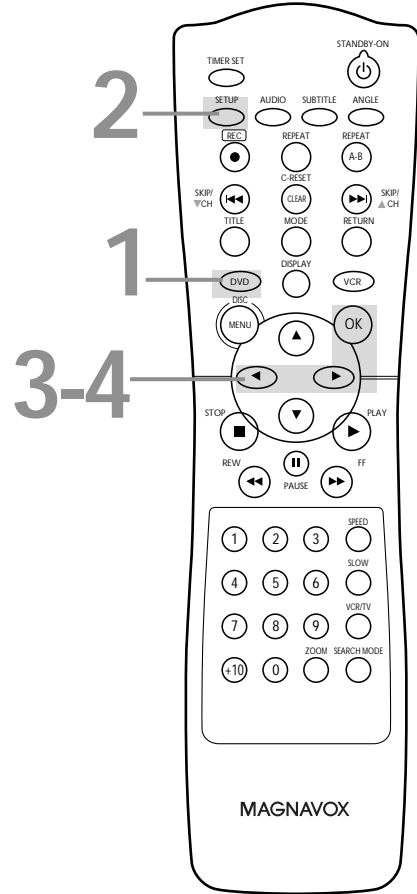
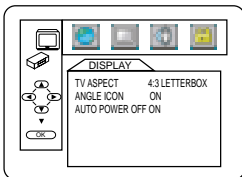

5 Press **▲** or **▼** to select an item, then press **OK**.
 ● If you selected **TV ASPECT**, press **▲** or **▼** to select a setting, then press **OK**.

Choose **4:3 LETTER BOX** if you want to see the entire, widened picture with black bars at the top and bottom of the screen. This looks like the picture you see when watching movies in a theater. This setting is possible only if the DVD was recorded in the letter-box or widescreen format.

Choose **4:3 PAN & SCAN** for a full height picture, with both sides trimmed. Some companies refer to this as reformatting the picture to fit your TV screen and may call it the regular or normal format.

Choose **16:9 WIDE** if a widescreen TV is connected to the DVD/VCR.

● If you selected **ANGLE ICON**, press **OK** repeatedly to turn **ANGLE ICON ON** or **OFF**. The default setting is **ON**. Choose **ON** to see the Angle icon when multiple camera angles are available during DVD playback. *Details are on page 55.* Choose **OFF** to disable the Angle icon.

● If you selected **AUTO POWER OFF**, press **OK** repeatedly to set **AUTO POWER OFF** to **ON** or **OFF**. The default setting is **ON**. Choose **ON** if you want the DVD/VCR to switch to VCR mode automatically if there is no activity at the DVD Player for 35 minutes.

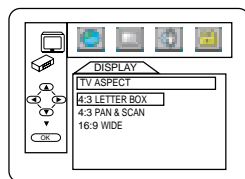

TV ASPECT

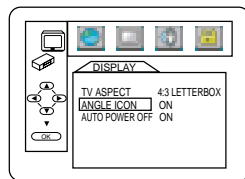

ANGLE ICON

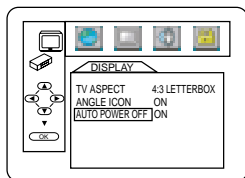

AUTO POWER OFF

6 Press **SETUP** to remove the menus.

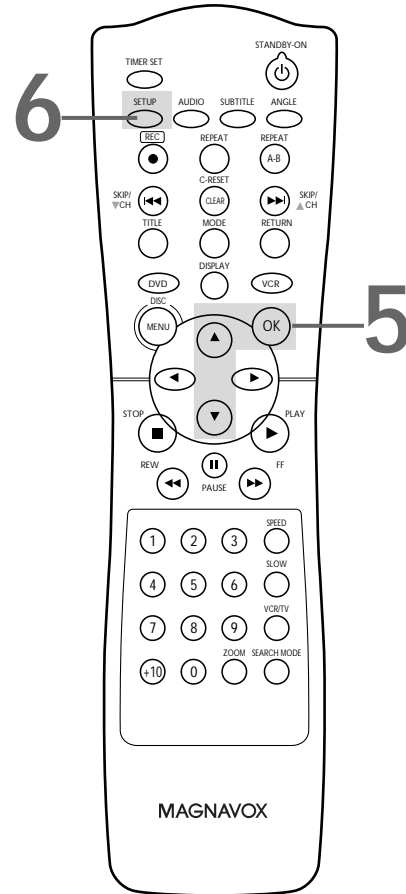

Helpful Hints

- Selecting a different **TV ASPECT** setting is only effective if it is available on the DVD. Check the DVD Disc menu or case for details.
- You also can adjust **TV ASPECT** in the **QUICK SETUP** menu that appears when you first press the **SETUP** button. With **QUICK** selected, press **OK**. Press **▼** to select **TV ASPECT**, then press **OK**. Press **▲** or **▼** to choose a setting, then press **OK**. Press **SETUP** to remove the menu.

66 Language

You can use the LANGUAGE settings to select different languages for the Audio or Subtitles of DVDs, as well as languages for DVD Disc menus and the menus of the DVD Player SETUP menus.

- 1 Press **DVD** to put the DVD/VCR in DVD mode.
- 2 While playback is stopped, press **SETUP**. The **QUICK SETUP** screen appears.
- 3 Press **▶** to select **CUSTOM** at the top of the menu, then press **OK**.

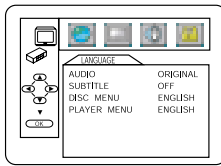
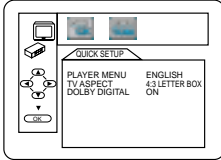

- 4 The Language menu () will be selected. Press **OK**.

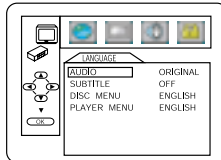

- 5 Press **▲** or **▼** to select **AUDIO**, **SUBTITLE**, **DISC MENU**, or **PLAYER MENU**. Then, press **OK**. The language options for the selected item will appear.

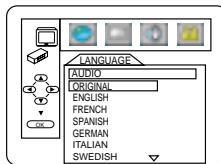

AUDIO: The DVD's audio plays in the selected language.



SUBTITLE: Subtitles appear in the chosen language.

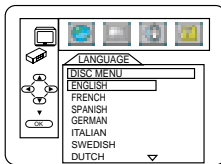

DISC MENU: A DVD's Disc menu appears in the chosen language.



PLAYER MENU: The DVD Player's Setup menu can be in English, French, or Spanish only.

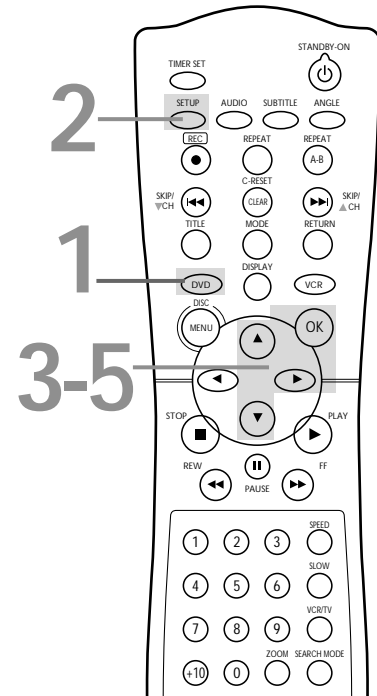

Helpful Hints

- If the DVD's default settings for Audio and Subtitle are the same language, the subtitles may not show unless you turn them on.
- Use the **AUDIO** and **SUBTITLE** buttons to select Audio and Subtitles available on the DVD. Details are on pages 55 and 58.
- If you set **AUDIO** to **ORIGINAL**, the default setting of the DVD Audio will play.
- If you set **PLAYER MENU** to **French** or **Spanish** and need **English**: Follow steps 1-3. At step 4, the **IDIOMA** or **LANGUE** menu will appear. Press **OK**. Press **▼** to select **MENU DU LECTEUR** or **MENU REPRODUC.**, then press **OK**. Press **▲** to select **ENGLISH**, then press **OK**. The menu will change to **English**. Press **SETUP** to remove the menu.
- You can change the **PLAYER MENU** language in the **QUICK SETUP** menu that appears when you first press **SETUP**. With **QUICK** selected, press **OK**. **PLAYER MENU** will be selected. Press **OK**. Press **▲** or **▼** to choose a language, then press **OK**. Press **SETUP** to remove the menu.

- 6** Press **▲** or **▼** to select a language, then press **OK**. The language list continues on multiple screens. Press **▲** or **▼** to move to the other screens.
- If you select **OTHER** for **AUDIO**, **SUBTITLE**, or **DISC MENU**, press four Number buttons to enter the code for the language you desire. Use the Language Codes below. The language or language code you select will appear in the Language menu beside **AUDIO**, **SUBTITLE**, or **DISC MENU**.

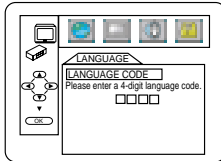

- You can select other languages for **AUDIO**, **SUBTITLE**, and **DISC MENU** only if the language is available on the Disc. If the language you select is not recorded on the DVD, changing these settings will have no effect.

- 7** Press **SETUP** to remove the menu.

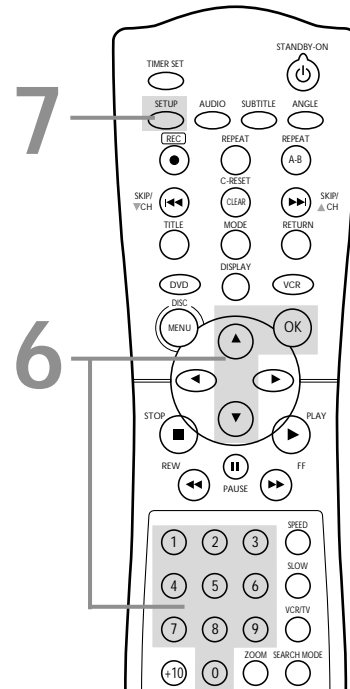

Language Codes

A-B	English	5160	Kannada	5760	Panjabi	6247	T		
Abkhazian	4748	Esperanto	5161	Kashmiri	5765	Pashto	6265	Tagalog	6658
Afar	4747	Estonian	5166	Kazakh	5757	Persian	5247	Tajik	6653
Afrikaans	4752	F-H		Kinyarwanda	6469	Polish	6258	Tamil	6647
Albanian	6563	Faroese	5261	Kirghiz	5771	Portuguese	6266	Tatar	6666
Amharic	4759	Fiji	5256	Kirundi	6460	Pushto	6265	Telugu	6651
Arabic	4764	Finnish	5255	Korean	5761	Quechua	6367	Thai	6654
Armenian	5471	French	5264	Kurdish	5767	Rhaeto-Romance	6459	Tibetan	4861
Assamese	4765	Frisian	5271	L-N		Romanian	6461	Tigrinya	6655
Aymara	4771	Gaelic (Scots)	5350	Laothian	5861	Russian	6467	Tonga	6661
Azerbaijani	4772	Galician	5358	Latin	5847	S		Tsonga	6665
Bangla	4860	Georgian	5747	Latvian	5868	Samoan	6559	Turkish	6664
Bashkir	4847	German	5051	Lettish	5868	Sangho	6553	Turkmen	6657
Basque	5167	Greek	5158	Lingala	5860	Sanskrit	6547	Twi	6669
Bengali	4860	Greenlandic	5758	Lithuanian	5866	Serbian	6564	U-Z	
Bhutani	5072	Guarani	5360	Macedonian	5957	Serbo-Croatian	6554	Ukrainian	6757
Bihari	4854	Gujarati	5367	Malagasy	5953	Sesotho	6566	Urdu	6764
Bislama	4855	Hausa	5447	Malay	5965	Setswana	6660	Uzbek	6772
Breton	4864	Hebrew	5569	Malayalam	5958	Shona	6560	Vietnamese	6855
Bulgarian	4853	Hindi	5455	Maltese	5966	Sindhi	6550	Volapuk	6861
Burmese	5971	Hungarian	5467	Maori	5955	Singhalese	6555	Welsh	4971
Byelorussian	4851	I-K		Marathi	5964	Siswat	6565	Wolof	6961
C-E		Icelandic	5565	Moldavian	5961	Slovak	6557	Xhosa	7054
Cambodian	5759	Indonesian	5560	Mongolian	5960	Slovenian	6558	Yiddish	5655
Catalan	4947	Interlingua	5547	Nauru	6047	Somali	6561	Yoruba	7161
Chinese	7254	Interlingue	5551	Nepali	6051	Spanish	5165	Zulu	7267
Corsican	4961	Inupiak	5557	Norwegian	6061	Sundanese	6567		
Croatian	5464	Irish	5347	O-R		Swahili	6569		
Czech	4965	Italian	5566	Occitan	6149	Swedish	6568		
Danish	5047	Japanese	5647	Oriya	6164				
Dutch	6058	Javanese	5669	Oromo (Afan)	6159				

68 Audio

Change Audio settings based on other equipment you connected to the DVD/VCR or according to your Disc sound features. These settings only affect the Disc Audio playback from the DVD Player of the DVD/VCR.

- 1 Press **DVD** to put the DVD/VCR in DVD mode.
- 2 While playback is stopped, press **SETUP**. The QUICK SETUP screen will appear.

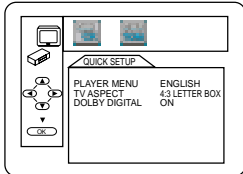

- 3 Press **▶** to select **CUSTOM** at the top of the menu, then press **OK**.

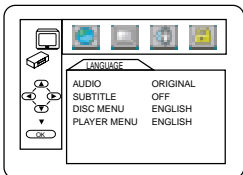

- 4 Press **▶** to select **AUDIO** (), then press **OK**.
- 5 Press **▲** or **▼** to select **DRC**, **DOLBY DIGITAL** or **DOWN SAMPLING**, then follow step 6 accordingly.

- 6
 - If you selected **DRC**, press **OK** repeatedly to turn Dynamic Range Control (DRC) **ON** or **OFF**. Choosing **ON** compresses the range of volume by suppressing loud sounds and raising low sounds.
 - If you selected **DOLBY DIGITAL**, press **OK** repeatedly to select **ON** or **OFF**. Select **ON** if you used the **COAXIAL DIGITAL AUDIO OUT** jack to connect the DVD/VCR to a stereo that is Dolby Digital compatible. *Details are on page 15.* Otherwise, choose **OFF**.
 - If you selected **DOWN SAMPLING**, press **OK** repeatedly to choose **ON** or **OFF**. Choose **ON** to set downsampling to 48 kHz. Choose **OFF** to set downsampling to 96 kHz.

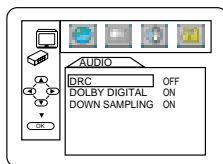

DRC

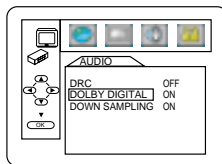

Dolby Digital

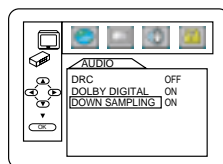

Down Sampling

- 7 Press **SETUP** to remove the menu.

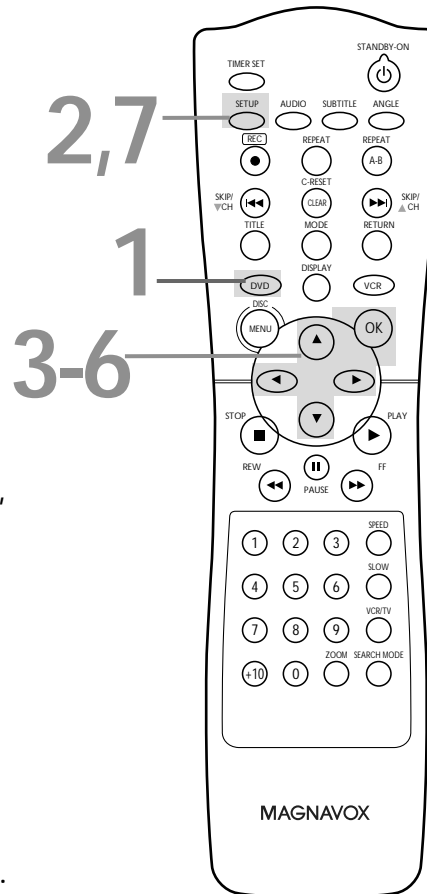

Helpful Hints

- Dolby Digital sound must be available on the DVD.
- You can adjust **DOLBY DIGITAL** in the **QUICK SETUP** menu that appears when you first press **SETUP**. With **QUICK** selected, press **OK**. Press **▼** to select **DOLBY DIGITAL**. Press **OK** to choose **ON** or **OFF**. Press **SETUP** to remove the menu.
- When you play a Disc that has copyright protection, downsampling will be at 48 kHz, even if you set **DOWN SAMPLING** to **OFF**.

1 Press DVD to put the DVD/VCR in DVD mode.

2 Press DISPLAY repeatedly to see the following displays during DVD playback.

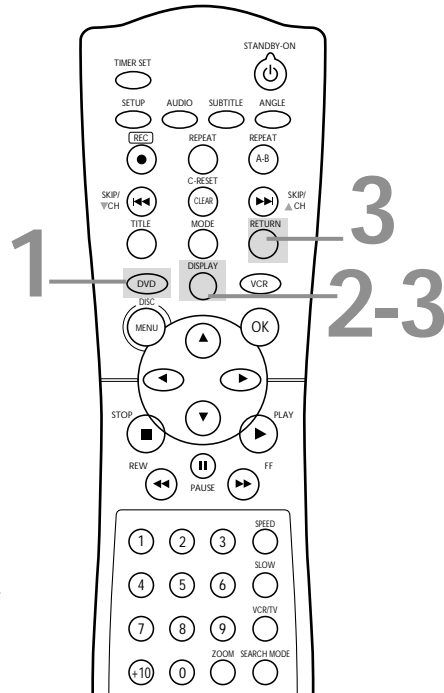
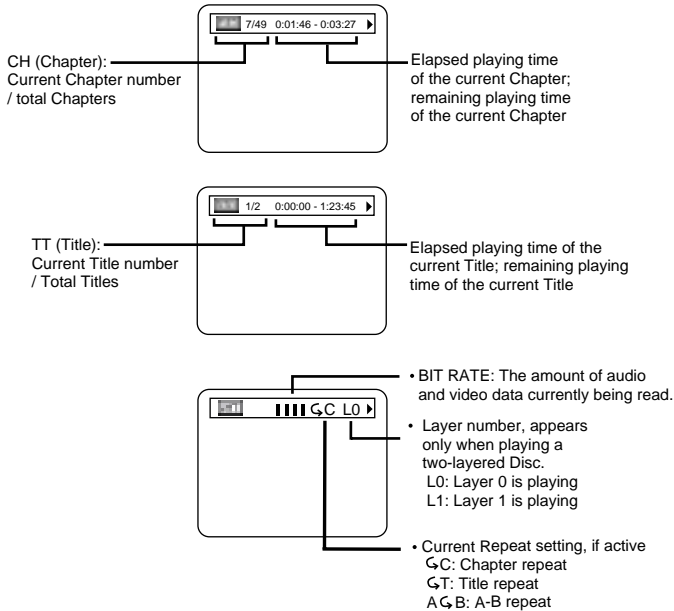

3 Press DISPLAY repeatedly or press RETURN to remove the display.

1 Press DVD to put the DVD/VCR in DVD mode.

2 Press DISPLAY repeatedly to see the following displays during Audio CD playback.

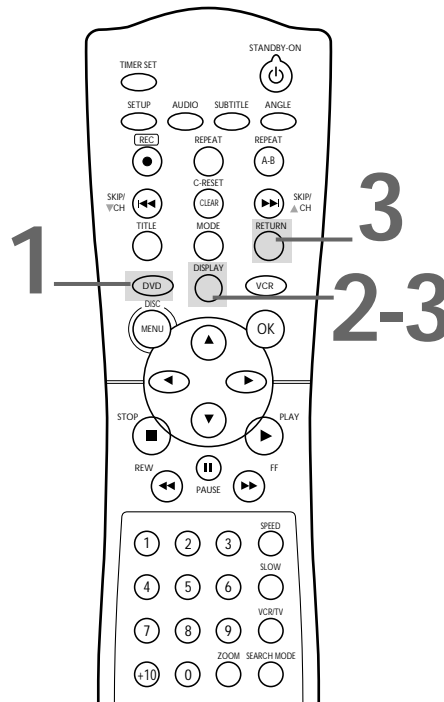
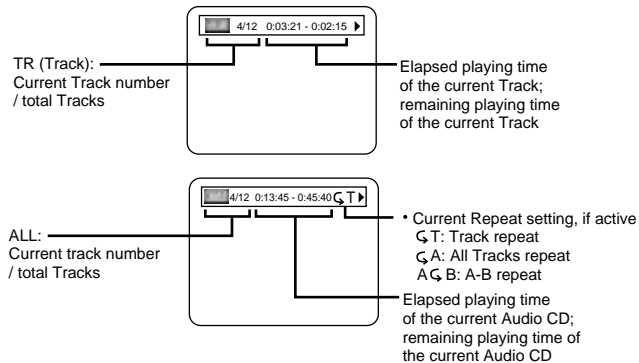

3 Press DISPLAY repeatedly or press RETURN to remove the display.

70 Black Level, Virtual Surround

Black Level

Adjust Black Level to brighten the DVD picture during playback.

- 1 Press DVD to put the DVD/VCR in DVD mode.
- 2 During DVD playback, press MODE so the Black Level icon shows in the top left corner of the TV screen.
 ON
- 3 Within 10 seconds, press OK repeatedly to choose ON or OFF. ON brightens the dark parts of the picture. OFF shows the original picture as recorded.

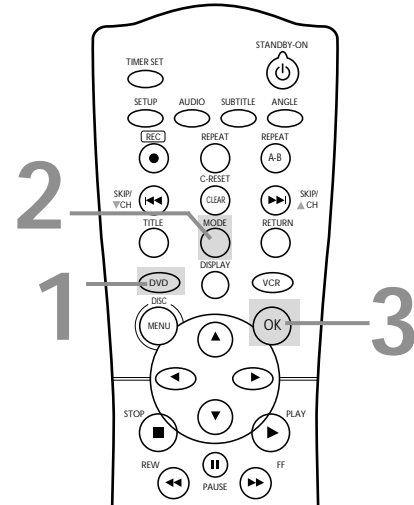

Virtual Surround

You can enjoy improved stereo sound when you play DVDs, Audio CDs, or MP3 files recorded in Dolby Digital or Pulse Code Modulation (PCM). Check the Disc case for details on availability.

- 1 Press DVD.
- 2 During Disc playback, press MODE so the Virtual Surround icon appears in the top left corner of the TV screen.
- 3 While the Virtual Surround icon appears, press OK to choose 1, 2, or OFF. The default setting is OFF. The icon will disappear after about 10 seconds.

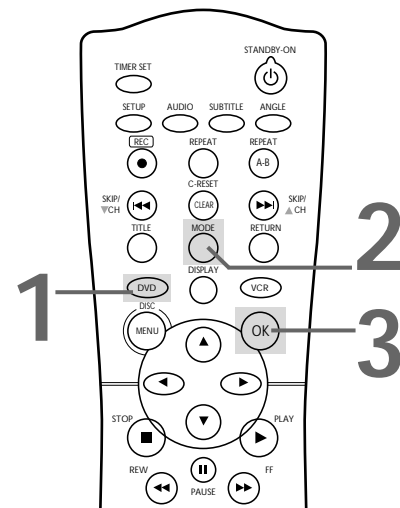

Helpful Hints

- Virtual Surround is available only when the DVD/VCR is connected to a Stereo using the red and white DVD/VCR AUDIO OUT jacks on the DVD/VCR.
- Virtual Surround is active only if you set Stereo Sound Mode to Stereo. Details are on page 58.

Cleaning the DVD/VCR

- Wipe the front panel and other exterior surfaces of the DVD/VCR with a soft, slightly damp cloth.
- Never use a solvent, thinner, benzene, or alcohol to clean the DVD/VCR. Do not spray insecticide liquid near the DVD/VCR. Such chemicals may discolor the surface or damage the DVD/VCR.

Cleaning a Disc

- Use a soft, dry cloth to wipe the Disc.
- Wipe the Disc in a straight line from the center to the edge. Never wipe the Disc in a circular motion.
- Do not use detergent or abrasive cleaning agents.
- Handle the Discs so fingerprints and dust do not adhere to the Discs.
- Always store the Disc in its protective case when it is not in use.

Checking the Laser

- If the DVD/VCR does not operate as described in this manual, the DVD Player's laser may be dirty. Consult an Authorized Service Center for inspection and cleaning of the laser.

Caring for Video Cassettes

- Use only cassettes with the **VHS** mark.
- Remove any light adhesive stick-on notes from the video cassette before putting the cassette in the VCR. Removable labels can jam the VCR.

Caring for the VCR's Video Heads

- Periodic maintenance is required to maintain your DVD/VCR's excellent performance. The VCR has an Automatic Head Cleaner. However, the video heads will require replacement eventually. Only an authorized service center should perform this service.

72 Glossary

AUDIO IN/OUT Jacks: jacks on the front and back of the DVD/VCR that receive audio from another source (IN) or send audio to another system (OUT). These jacks are red (right) and white (left).

Automatic Channel Setup: process in which the VCR memorizes all available TV channels. Then, when you press SKIP ►►/CH▲ or SKIP ◄◄/CH▼ in VCR mode, you only scan through channels you receive.

Bands: settings that allow you to tune channels.

- **Antenna** – VHF (very high frequency; channels 2-13) and UHF (ultra high frequency; channels 14-69).
- **Cable** – standard channels 1-125 can be received without a Cable Box.

Cable Box/DBS Output Channel: 03 or 04.

COAXIAL DIGITAL AUDIO OUT jack: Sends digital audio to a Stereo, allowing you to adjust the volume at the Stereo. This connection provides the 5.1 channel surround sound as heard in movie theaters. This jack is black.

COMPONENT VIDEO OUT (Y, CR, CB) Jacks: jacks on the back of the DVD/VCR that send high-quality DVD video to a TV with Component Video In jacks. This connection provides the best picture quality for the DVD Player of the DVD/VCR.

Dolby Digital: A surround sound system that provides 5.1 channel sound as used in movie theaters.

DTS: Digital Theater Systems. This is a surround sound system, but it is different from Dolby Digital. The formats were developed by different companies.

Dubbing: copying a video cassette using another VCR.

HQ: high quality; a feature in the VCR circuitry which provides enhanced picture detail.

Line Input: The channel to which you set your DVD/VCR during video cassette copying. If you connected the other video equipment to the AUDIO and VIDEO In jacks on the front of the DVD/VCR, select L2. If you used the AUDIO and VIDEO IN jacks on the back of the DVD/VCR, select L1. If you accidentally enter Line Input mode, press SKIP ►►/CH▲ or SKIP ◄◄/CH▼ or the Number buttons to select another channel.

OTR: One-Touch Recording; a timed recording on the VCR that starts immediately and records for 30 minutes to eight hours.

RF coaxial cable: A black cable supplied with your DVD/VCR. Use it to connect your DVD/VCR to your TV, Cable Box, or Satellite Receiver.

S-Video: Produces a clearer DVD picture by sending separate signals for the luminance and the color. S-Video only provides a picture for the DVD Player of the DVD/VCR.

Tape Speeds: how fast the video cassette travels during a recording or playback. The faster the tape speed, the better the picture quality. Slower tape speeds affect picture quality, but you can record more onto a videotape.

- **SP** (standard play) – fastest tape speed (recording time for a T120 tape is approximately two hours); best picture quality.
- **LP** (long play) – average tape speed. You cannot record in LP with this VCR. If tapes were recorded on a different VCR in LP speed, the tape will play in LP on the DVD/VCR.
- **SLP** (super long play) – slowest tape speed (recording time for a T120 tape is approximately six hours). This speed allows the maximum recording on a single videotape.

VIDEO IN/OUT Jacks: jacks on the front and back of the DVD/VCR that receive video from another source (IN) or send video to other video equipment or a TV (OUT). These jacks are yellow.

VCR Video Heads

Four heads - Hi-Fi

Antenna

VHF/UHF – 75 ohm external antenna terminal

VHF Output Signal

Channel 03 or 04
75 ohms unbalanced

DVD Color System

NTSC

Frequency Response

DVD (linear sound):
20 Hz to 22 kHz (sample rate: 48 kHz)
20 Hz to 44 kHz (sample rate: 96 kHz)
Audio CD: 20 Hz to 20 kHz

Signal-to-Noise Ratio

Audio CD: 120 dB JEITIA
(Japan Electronics and Information Technology Industries Association)

Dynamic Range

DVD (linear sound): 102 dB
Audio CD: 99 dB (JEITIA)

Total Distortion Factor

Audio CD: 0.003% (JEITIA)
DVD: 0.0025%

Wow and Flutter

Below the measurement limitation
(±0.001% W PEAK) (JEITIA)

Power Requirement

120V AC +/- 10%, 60 Hz +/- 0.5%

Power Consumption

Power on: 24 W
Power off: 7.0 W

Operating Temperature

41°F (5°C) to 104°F (40°C)

Relative Humidity

30% to 80%

Dimensions

17-1/8" (W) x 3-7/8" (H) x 10-1/2" (D)
(435mm x 99mm x 266mm)

Weight

8.8 lbs. (4.0 kg.)

NOTE: Designs and specifications are subject to change without notice.

74 Helpful Hints

If you are having problems with your product, check this list of problems and possible solutions before requesting service. You may be able to solve the problem yourself.

If you need to call a customer service representative, please know the model number and serial number of your product before you call. This information is displayed on the back of the product. Also, please take a moment to identify the problem you are having, and be prepared to explain this to the representative. If you believe the representative will need to help you with operations, please stay near the product. Our representatives will be happy to assist you.

The DVD/VCR has no power.

- Make sure the power cord is connected completely to an AC (alternating current) outlet.
- Press the STANDBY-ON button to turn on the DVD/VCR. The DVD/VCR turns on in the mode it was in when you turned it off. If there has been a power failure, it will turn on in VCR mode. Press DVD to put the unit in DVD mode. Press VCR to put the unit in VCR mode. Or, press OUTPUT on the front of the DVD/VCR to switch between the two modes.

The remote control will not operate the DVD/VCR.

- Aim the remote control directly at the remote sensor (IR) on the front of the DVD/VCR, not toward the TV. *Details are on page 22.*
- Remove all obstacles between the remote control and the DVD/VCR.
- Inspect and/or replace the batteries in the remote control. *Details are on page 16.*
- Use the remote control within 23 feet of the DVD/VCR.
- When using the DVD Player, press the DVD button, then try the other DVD feature buttons. Press DVD so the red DVD light appears on the front of the DVD/VCR. This means the DVD/VCR is in DVD mode.
- To use the VCR, press VCR, then try the other VCR feature buttons. Press VCR so the green VCR light appears on the front of the DVD/VCR. This means the DVD/VCR is in VCR mode.

There is no picture in DVD mode.

- Make sure the video cable is connected correctly. You may connect either the yellow video cable (supplied), an optional S-Video cable, or optional component video cables. Make sure the TV is set to the correct Video In channel (usually the AUX IN, A/V IN, Auxiliary In, EXT or External In, Component Video In, or S-Video In channel). Check your TV owner's manual for details. *Details are on pages 11-15.*
- If you only used the supplied black RF coaxial cable, *details are on pages 8-10.* Make sure the TV is set to channel 3 or 4 (the output channel of the DVD/VCR). Or, if you have a Cable Box/Satellite Receiver, make sure the TV is set to the Cable Box/Satellite Receiver output channel (usually 03 or 04).
- Insert a DVD that is playable on this DVD/VCR. *Details are on page six.*
- Make sure the DVD/VCR is in DVD mode. Press DVD or OUTPUT so the red DVD light appears on the front of the DVD/VCR.

Disc cannot play.

- Insert a playable Disc. *Details are on page six.*
- Place the Disc correctly in the Disc tray. If the Disc is one-sided, place the Disc in the tray with the label facing up. If the Disc is two-sided, make sure the label of the side you want to play is facing up.
- Clean the Disc. Make sure the Disc is not scratched or warped.
- Cancel the Parental Controls, enter the password, or change the control level. *Details are on pages 56-57.*
- Make sure the Disc is labelled for use in Region 1 or ALL regions and is NTSC compatible. *Details are on page six.*

There is no sound.

- Connect the audio cables firmly. Make sure the cables are connected to the AUDIO IN jacks on the TV or Stereo. *Details are on pages 11-14.*
- Check the audio settings of the DVD Player. *Details are on page 68.*
- Check the audio settings of the DVD. For example, you may have selected "soundtrack" playback or an unavailable sound setting (such as Dolby Digital). *Details are on pages 58 and 68.* Try other sound options provided in the DVD Disc menu.
- If you used audio cables (instead of only using the supplied black RF coaxial cable) make sure the TV or Stereo is set to the correct Audio In channel (usually the AUX IN, Auxiliary In, A/V IN, Audio In, or External In channel). See your TV or Stereo owner's manual for details.

The picture is distorted.

- Connect the DVD/VCR directly to the TV. *Details are on pages 8-15.* Do not connect the DVD/VCR to a VCR, then connect the VCR to the TV. Copyright protection systems in the VCR could distort the picture playing on the DVD/VCR.
- There are some cases where a Disc or videotape picture may be distorted slightly because of the quality in which it was recorded. This is not a malfunction of the DVD/VCR.
- Make sure the Disc is compatible with the DVD Player of the DVD/VCR. *Details are on page six.*

You cannot change the camera angle of a DVD.

- The DVD might not contain segments recorded from different camera angles. See if multiple angles are available by referring to the Disc case or DVD Disc menu. *Details are on page 55.*

You cannot change the audio or subtitle language of a DVD.

- The DVD does not contain audio or subtitles in the desired language. Not all DVDs contain audio or subtitles in multiple languages. See if other languages are available by referring to the Disc case or DVD Disc menu. *Details are on pages 55 and 58.*

An X appears in the top right corner of the TV screen when you try a DVD feature.

- The operation is not available at the current time or the feature is not available on the Disc. Some features are only available during playback. Others can be accessed only if play is stopped. Try stopping or playing the Disc, then try the feature again.

The DVD/VCR switches from DVD mode to VCR mode after 35 minutes of no activity.

- When AUTO POWER OFF is set to ON, the DVD/VCR switches itself from DVD mode to VCR mode if Disc playback stops for more than 35 minutes and you press no buttons on the remote or the DVD/VCR. *Details are on pages 64-65.*

A screen saver appears on the TV screen during DVD mode.

- The DVD logo will appear on the TV screen when you stop Disc playback. You cannot remove it.

You want to use the DVD Player during a VCR timer recording or while the TIMER REC light appears.

- Press STANDBY-ON to turn on the DVD/VCR. Press DVD to choose DVD mode, then continue with other DVD features as described in this manual.

76 Helpful Hints (cont'd)

Power Failure

- VCR timer recordings, clock setting, language selection, and channel setup may be lost if the power fails. See pages 26-30 to set up the channels, clock, and language again. See pages 36-38 to reprogram your timer recordings.

The VCR will not record a TV program.

- Put the DVD/VCR in VCR mode. Press VCR or OUTPUT so the green VCR light appears on the front of the DVD/VCR.
- Check the connections between the DVD/VCR, TV, antenna/Cable TV signal, and Cable Box/Satellite Receiver (if applicable). *Details are on pages 8-15.* For VCR features, you must connect the DVD/VCR to a TV with the RF coaxial cable or the yellow video cable as described on pages 8-11.
- Make sure the video cassette has a record tab. *Details are on page 32.*

The VCR will not perform a timer recording.

- Make sure the recording start and stop times are set correctly. *Details are on pages 36-38.*
- Make sure a tape is in the VCR and the tape has a record tab. *Details are on page 32.* If, after programming a timer recording, you press TIMER SET without putting a tape in the DVD/VCR, the TIMER REC light will blink.
- If the record tab on a tape is missing, the DVD/VCR will eject the tape. The TIMER REC light will blink.
- Press TIMER SET to put the DVD/VCR in standby mode for the timer recording. The TIMER REC light should appear on the front of the DVD/VCR.
- Make sure the VCR clock is set. *Details are on pages 28-29.*
- The VCR may not perform or continue a timer recording if the power fails.
- If you have a Cable Box/Satellite Receiver, set timer recordings differently. *Details are on page nine.*
- Finish programming a timer recording at least five minutes before it is set to begin.
- 12 p.m. is noon; 12 a.m. is midnight.

There is no picture or the picture is noisy or has streaks during video cassette playback.

- Put the DVD/VCR in VCR mode. Press VCR or OUTPUT so the green VCR light appears on the front of the DVD/VCR.
- If you used the supplied RF coaxial cable to connect the DVD/VCR to the TV, make sure the TV is on the same channel as the DVD/VCR's output channel (03 or 04). The DVD/VCR's output channel is channel 3 when you receive it. To change it to channel 4, *see page eight.* Make sure channel 03 or 04 is properly adjusted at the TV.
Or, if you connected the DVD/VCR to the TV using audio and video cables, select the correct Video In channel at the TV. *Details are on pages 8-13.*
- Adjust the tracking. *Details are on page 44.*
- TVs placed too close to the DVD/VCR can cause interference during tape playback. Move the DVD/VCR away from the TV.

The Number buttons won't work for TV channels above 69.

- Enter channel numbers as a two-digit number. If you want to select channels 100 and above, enter channel numbers as a three-digit number. If you do not have Cable TV, only channels 2-69 are available.

TV programs cannot be watched normally.

- Check the connections between the DVD/VCR, TV, antenna/Cable TV signal, and Cable Box/Satellite Receiver (if applicable). *Details are on pages 8-15.*

Poor reception

- You may need to tune your TV again. Or, reset channels at the VCR using CHANNEL SET UP. *Details are on pages 26-27.*

You cannot insert a video cassette.

- Insert the tape, window side up, with the record tab facing you.
- Make sure a tape isn't already in the VCR by pressing STOP/EJECT ■▲ on the front of the DVD/VCR.
- Gently push on the center of the tape when putting it in the VCR. Never force the tape into the VCR.
- If a timer recording is set, you cannot insert a tape without a record tab.

You cannot remove the tape.

- Make sure the power plug is completely connected to a power outlet.
- If you have set a timer recording, press TIMER SET to delay the recording. The TIMER REC light will turn off. Then, press STOP/EJECT ■▲ on the front of the DVD/VCR to eject the tape. Insert another tape and press TIMER SET to reset the timer recording.
- Unplug the DVD/VCR power cord for five minutes. Then, plug in the power cord again and press STANDBY-ON on the DVD/VCR. Press STOP/EJECT ■▲ on the DVD/VCR three to five times. If the tape still does not eject, you may need to have an authorized servicer remove the tape.

DVD/VCR ejects the tape when you press REC, RECORD, or TIMER SET.

- Make sure the tape has a record tab. *Details are on page 32.*

Satellite Receiver Hookups

- Watching one TV channel while recording another may not be possible if you have a Satellite Receiver. Set your TV to channel 03 or 04, then make your channel selections at the Satellite Receiver.
- With many Satellite Receiver hookups, if you use audio and video cables to connect your DVD/VCR to your TV, you will have to put your DVD/VCR in Line Input mode (L1 or L2).

Line Input mode

- If you accidentally enter Line Input mode (L1 or L2 will appear on your TV screen briefly), press SKIP ►►/CH▲ or SKIP ◄◄/CH▼ or the Number buttons to select another channel.

Hi-Fi Stereo Sound

- During playback, Hi-Fi audio may normally revert to normal audio when you adjust tracking.
- When connecting the DVD/VCR to a TV with the red and white audio cables, you will only get stereo sound if you connect the DVD/VCR AUDIO OUT jacks on the DVD/VCR to the AUDIO IN jacks on your TV, and if the TV is on its Audio/Video In channel. See your TV owner's manual for details.
- When you connect the DVD/VCR AUDIO OUT jacks on the DVD/VCR to the AUDIO IN jacks on your TV, the stereo light on the TV might not glow. If the status display indicates you are receiving stereo, you are. *Details are on page 45.*
- Only tapes recorded in Hi-Fi audio will play in Hi-Fi audio. Tapes recorded in normal audio will play in monaural (single-channel) audio.

Cleaning the Video Heads

- Your DVD/VCR automatically cleans the video heads of the VCR each time you insert a tape. However, the heads may become dirty. If so, have an authorized servicer clean the video heads. Eventually, the heads may need to be replaced.

The playback picture is too dim, too bright, or fluctuates in brightness.

- Some programs may be broadcast with copyright protection technology in order to protect the rights of copyright owners. This technology is used on programs that are recorded on video cassettes or DVDs, as well as some programs broadcast by antenna/cable/satellite television channels. Programs broadcast with copyright protection may not record clearly. Likewise, if you play a tape that is a recording of a copyright protected program, the picture may not be clear. Tapes of copyright protected programs may have a picture that is dark or dim, or the brightness of the picture may fluctuate. Therefore, avoid recording or playing copies of copyright protected programs.
- This DVD/VCR incorporates copyright protection technology that is protected by method claims of certain U.S. patents and other intellectual property rights owned by Macrovision Corporation and other rights owners. Use of this copyright protection technology must be authorized by Macrovision Corporation and is intended for home and other limited viewing uses only, unless otherwise authorized by Macrovision Corporation. Reverse engineering or disassembly is prohibited.

78 Limited Warranty

Digital Video Disc Player / Video Cassette Recorder Combination 90 days Free Product Exchange / 91 days–One Year Reduced-Cost Exchange

WHO IS COVERED?

You must have proof of the date of purchase to exchange your product. A sales receipt or other document showing the date that you purchased the product is considered such proof.

WHAT IS COVERED?

Warranty coverage begins the day you buy your product. For 90 days thereafter, you may exchange the defective product for a new or renewed product through Magnavox. From 91 days to one year from the date of purchase, you will pay a preset exchange fee to obtain a new or renewed product. Follow the exchange procedures on the next page. This exchange opportunity ends one year after the date of purchase. The replacement product is covered only for the warranty period of the original product. When the warranty on the original product expires, the warranty on all replaced products also expires.

When it is necessary for you to ship the product to Magnavox for exchange, you will pay the shipping costs for shipment to Magnavox. Magnavox will pay the shipping costs when returning a product to you.

WHAT IS EXCLUDED?

Your warranty does not cover:

- shipping charges to return defective product.
- labor charges for installation or setup of the product, adjustment of customer controls on the product, and installation or repair of antenna systems outside of the product.
- product repair and/or part replacement because of improper installation, abuse, neglect, misuse, accident, unauthorized repair or other cause not within the control of Magnavox.
- reception problems caused by signal conditions or cable or antenna systems outside the product.
- a product that requires modification or adaptation to enable it to operate in any country other than the country for which it was designed, manufactured, approved and/or authorized, or repair of products damaged by these modifications.
- incidental or consequential damages resulting from the product. (Some states do not allow the exclusion of incidental or consequential damages, so the above exclusion may not apply to you. This includes, but is not limited to, prerecorded material, whether copyrighted or not copyrighted.)
- damage caused by the use of non-VHS tapes or tapes that have not been tested and labeled for use in two, four, six, and eight hour VHS recorders.
- a product that is used for commercial or institutional purposes (including but not limited to rental purposes).

WHERE IS EXCHANGE AVAILABLE?

Warranty exchange is available in all countries where the product is officially distributed by Magnavox. In countries where Magnavox does not distribute the product, the local Magnavox service organization will attempt to exchange the product, although there may be a delay if the appropriate product is not readily available.

MAKE SURE YOU KEEP...

Please keep your sales receipt or other document showing proof of date of purchase. Attach it to the owner's manual and keep both nearby. Also keep the original box and packing material in case you need to return your product.

BEFORE EXCHANGING THE PRODUCT...

Please check your owner's manual before exchanging the product. Adjustments of the controls discussed there may save you time and money.

LIMITATION OF LIABILITY AND REMEDY...

MAGNAVOX IS NOT LIABLE UNDER ANY CIRCUMSTANCES FOR ANY DIRECT, INDIRECT, SPECIAL, INCIDENTAL, OR CONSEQUENTIAL DAMAGES, HOWSOEVER INCURRED, EVEN IF NOTIFIED OF THE POSSIBILITY OF SUCH DAMAGES.

TO THE EXTENT PERMITTED BY LOCAL LAW, THE REMEDIES PROVIDED IN THIS WARRANTY STATEMENT ARE YOUR SOLE AND EXCLUSIVE REMEDY. THIS LIMITED WARRANTY GIVES YOU SPECIFIC LEGAL RIGHTS, AND YOU MAY ALSO HAVE OTHER RIGHTS WHICH VARY FROM STATE/PROVINCE TO STATE/PROVINCE.

TO EXCHANGE YOUR PRODUCT IN THE U.S.A., PUERTO RICO, OR U.S. VIRGIN ISLANDS...

FOLLOW THE INSTRUCTIONS STATED PREVIOUSLY IN THE "WHAT IS COVERED" SECTION, OR REFER TO THE EXCHANGE INSTRUCTIONS ON THE NEXT PAGE.

IN THE U.S.A., PUERTO RICO, AND U.S. VIRGIN ISLANDS, ALL IMPLIED WARRANTIES, INCLUDING THE IMPLIED WARRANTIES OF NON-INFRINGEMENT, MERCHANTABILITY AND FITNESS FOR A PARTICULAR PURPOSE, ARE SPECIFICALLY DISCLAIMED, AND TO THE EXTENT INCONSISTENT WITH LAW OF THE LOCALITY OF THE USER, LIMITED IN DURATION TO THE DURATION OF THIS EXPRESS WARRANTY. BECAUSE SOME STATES DO NOT ALLOW LIMITATIONS ON HOW LONG AN IMPLIED WARRANTY MAY LAST, THIS LIMITATION MAY NOT APPLY TO YOU.

TO EXCHANGE A PRODUCT IN CANADA...

Please contact Magnavox at:

1-800-705-2000

In Canada, this warranty is given in lieu of all other warranties. There are no other warranties, express or implied, including any implied warranties of merchantability or fitness for a particular purpose.

REMEMBER...

Please record below the model and serial numbers found on the product. Also, please fill out and mail your warranty registration card promptly. It will be easier for us to notify you if necessary.

MODEL # _____

SERIAL # _____

Magnavox, P.O. Box 520890, Miami, FL 33152 (402) 536-4171

EL6473E004 /1-03

Limited Warranty (cont'd) 79

EXCHANGE INSTRUCTIONS

To exchange your product with Magnavox (per the warranty conditions stated previously), remember:

- If you exchange the product within 90 days of the original purchase, there is no cost to you.
- If you exchange the product more than 90 days after but less than one year after the day of original purchase, contact Magnavox at 1-800-705-2000 to determine the preset cost for exchange.
- If you do not have your original sales receipt, or if you have any questions, call Magnavox at 1-800-705-2000.

To obtain a replacement product from Magnavox:

1. Contact Magnavox at 1-800-705-2000 to determine the cost for exchange.
2. Complete the Exchange Form below.
3. Pack the product and its accessories in the original box or a suitable alternative. You will receive replacement accessories with your replacement product. For packing details, call Magnavox at 1-800-705-2000.
4. Put the completed Exchange Form, a copy of the original sales receipt, and the proper payment amount into an envelope. DO NOT SEND CASH. Do not staple or clip these items together. Label the envelope "Return Documents Enclosed." Place this envelope in the box with the product.
5. Seal the box with packing tape and return the product via United Parcel Service (UPS), insured and freight prepaid, to the address provided by Magnavox. For details, call 1-800-705-2000. A replacement will be sent to you via UPS within 48 business hours of Magnavox' receipt of the product.

When it is necessary for you to ship the product to Magnavox for exchange, you will pay the shipping costs for shipment to Magnavox. Magnavox will pay the shipping costs when returning a product to you.

EXCHANGE FORM

Your Address (street address to which replacement should be delivered, no P.O. boxes allowed):

Name: _____

Street Address: _____

Apt. #: _____

City: _____

State/Province: _____

Zip Code/Postal Code: _____

Phone (day): _____

Phone (night): _____

Exchange Fee: _____ + Sales Tax: _____ = Total: _____

Method of Payment: (Check one. Please, no cash or CODs.)

_____ Check/Money order Check/Money order No. _____

	Account number	Expiration date
_____ American Express	_____	_____
_____ Visa	_____	_____
_____ Novus/Discover	_____	_____
_____ Mastercard	_____	_____

Signature: _____

Detailed reason for return, use additional paper if necessary: _____

Model Number _____ Serial Number _____

Remember, the return box should include the following:

- The product,
- Accessories supplied with the product, and
- Completed Exchange Form and sales receipt,
- Payment, if applicable.

80 Information Index

ac power cord	23	hi-fi stereo sound	47	rew (rewind) button	25, 43, 49
angle button	24, 55	hookups		rf coaxial cable	8-10
angle icon	65	cable box/dbs	9-10	safety precautions	3
ant-in (antenna in) jack	8-15, 23	component video	12	sap (second audio program)	45-46
ant-out (antenna out) jack	8-10, 23	S-video	13	search mode button	24, 42, 50-51
arrow buttons	24	stereo	14-15	searching	43, 49
audio button	25, 58	tv	8-15	sensor (remote)	22
audio in/out jacks	11-14, 22-23, 35	index search	42	setup button	24
audio settings	68	ir (infrared remote sensor)	22	skip ►►/ch▲,	
auto power off	65	jpeg	62	skip ◀◀/ch▼ buttons	25, 51
auto repeat	40	language (dvd)	66-67	slow button	25, 43
automatic		language (vcr)	30	slow motion	43, 59
tape playback	44	line input mode	35, 77	slp	72
tape rewind, eject	44	long play	72	sp	72
a-b repeat	53	lp	72	specifications	73
a-b repeat button	24, 53	markers	54	speed button	24
batteries	16	menus	5, 48	standard play	72
bit-rate display	69	mode button	25, 60-61	standby-on	
black level	70	mp3 display	63	button	22, 24
c-reset/clear button	25, 41	mp3 playback	62	light	21
camera angle	55	number buttons	24	status display (vcr)	31
cassette compartment	21	ok button	24	step-by-step playback	52
channel		on-screen status displays (vcr)	31	stereo broadcast	
adding	27	one-touch recording	34	hookups	11, 14
deleting	27	open/close button	19, 22	receiving/recording	46
selection	24	output button	22	stereo sound	58
setup	17, 26	parental controls	56-57	stereo TV hookups	11
chapters	50	password	56	still picture	43, 52
clock	21, 28-29	pause button	25, 43, 52, 59	stop button	25
coaxial (digital audio out) jack	15, 23	play button	18-19, 22, 24	stop/eject button	22
component video out jacks	12, 23	player menu	66	subtitle button	25, 55
connections	7-15	playing discs	19	super high speed searching	43
contents, table of	4	playing tapes	18	super long play	72
controls		power cord	23	s-video out jack	13, 23
dvd/vcr	22-23	program	60	table of contents	4
remote	24-25	quick setup	65, 66, 68	tape	
copyright protection	35, 77	random	61	duplication	35
counter	31, 41	rear panel	23	eject	22, 44, 77
disc menus	48, 66	rec (record) button	24, 32	speed	72
disc tray	20	rec (record) light	21	time search	42
disc/menu button	24, 48	record button	22, 32, 34	timer rec light	21, 38, 75
display button	25, 31, 69	recording		timer recording	
display messages	20	basic	32	cancelling	38
display panel	20-21	one channel/watching another	33	setting	36-38
displays	63, 69	prevention	32	timer set button	24, 36-38
dolby digital	68	timer	36-38	title button	24, 48
down sampling	68	remote control		titles	48
drc (dynamic range control)	68	batteries	16	tracking	44
duplication (dvd to videotape)	39	buttons	24-25	tracks	51
duplication (tape)	35	sensor	22	tv aspect	65
dvd button	25	repeat button	25, 53	tv hookups	8-15
dvd light	20	repeat (tape)	40	vcr button	25
ejecting a tape	22, 44, 77	repeat (discs)	53	vcr light	21
fast forward	43, 49	rerecording	35	vcr/tv button	25
ff (fast forward) button	24	resume	52	video in/out jacks	11, 14-15, 22-23
front panel	22	return button	24	virtual surround	70
glossary	72	reverse searching	43, 49	warranty	78-79
head cleaner	77			zoom	59
helpful hints	74-77			zoom button	24, 59



This owner's manual is made of recyclable materials. Remember to recycle!
 IB8412E003 Printed In China
 OVMN03481A / H9460UD * * * * *

Free Manuals Download Website

<http://myh66.com>

<http://usermanuals.us>

<http://www.somanuals.com>

<http://www.4manuals.cc>

<http://www.manual-lib.com>

<http://www.404manual.com>

<http://www.luxmanual.com>

<http://aubethermostatmanual.com>

Golf course search by state

<http://golfingnear.com>

Email search by domain

<http://emailbydomain.com>

Auto manuals search

<http://auto.somanuals.com>

TV manuals search

<http://tv.somanuals.com>