

OWNER'S MANUAL

MAGNAVOX

Smart. *Very smart.*[®]

MRD500VR

Digital Video Disc Player
Video Cassette Recorder
AM/FM Radio Tuner



NEED HELP? CALL US!

MAGNAVOX REPRESENTATIVES ARE READY TO HELP YOU WITH ANY QUESTIONS ABOUT YOUR NEW PRODUCT. WE CAN GUIDE YOU THROUGH CONNECTIONS, FIRST-TIME SETUP, AND ANY OF THE FEATURES.

WE WANT YOU TO START ENJOYING YOUR NEW PRODUCT RIGHT AWAY.

CALL US BEFORE YOU CONSIDER RETURNING THE PRODUCT.

1-800-705-2000

OR VISIT US ON THE WEB AT WWW.MAGNAVOX.COM



IMPORTANT!

RETURN YOUR WARRANTY REGISTRATION CARD WITHIN 10 DAYS.
SEE WHY INSIDE.

Return your Warranty Registration card today to ensure you receive all the benefits you're entitled to.

Once your MAGNAVOX purchase is registered, you're eligible to receive all the privileges of owning a MAGNAVOX product. So complete and return the Warranty Registration Card enclosed with your purchase at once. And take advantage of these important benefits.

Warranty Verification	Owner Confirmation	Model Registration
Registering your product within 10 days confirms your right to maximum protection under the terms and conditions of your MAGNAVOX warranty.	Your completed Warranty Registration Card serves as verification of ownership in the event of product theft or loss.	Returning your Warranty Registration Card right away guarantees you'll receive all the information and special offers which you qualify for as the owner of your model.

Congratulations on your purchase, and welcome to the "family!"

Dear MAGNAVOX product owner:

Thank you for your confidence in MAGNAVOX. You've selected one of the best-built, best-backed products available today. And we'll do everything in our power to keep you happy with your purchase for many years to come.

As a member of the MAGNAVOX "family," you're entitled to protection by one of the most comprehensive warranties and outstanding service networks in the industry.

What's more, your purchase guarantees you'll receive all the information and special offers for which you qualify, plus easy access to accessories from our convenient home shopping network.

And most importantly you can count on our uncompromising commitment to your total satisfaction.

All of this is our way of saying welcome-and thanks for investing in a MAGNAVOX product.

P.S. Remember, to get the most from your MAGNAVOX product, you must return your Warranty Registration Card within 10 days. So please mail it to us right now!



Know these safety symbols



⚡ This "bolt of lightning" indicates uninsulated material within your unit may cause an electrical shock. For the safety of everyone in your household, please do not remove product covering.

⚠ The "exclamation point" calls attention to features for which you should read the enclosed literature closely to prevent operating and maintenance problems.

WARNING: TO PREVENT FIRE OR SHOCK HAZARD, DO NOT EXPOSE THIS EQUIPMENT TO RAIN OR MOISTURE.

CAUTION: To prevent electric shock, match wide blade of plug to wide slot, fully insert.

ATTENTION: Pour éviter les choc électriques, introduire la lame la plus large de la fiche dans la borne correspondante de la prise et pousser jusqu'au fond.

For Customer Use

Enter below the Serial No. which is located on the rear of the cabinet. Retain this information for future reference.

Model No. _____
Serial No. _____

Visit our World Wide Web Site at <http://www.magnavox.com>

Safety and General Information 3

Safety Precautions

Warning: To prevent fire or shock hazard, do not expose this equipment to rain or moisture.

Federal Communications Commission (FCC) Warning: Any unauthorized changes or modifications to this equipment void the user's authority to operate it.

Department of Health and Human Services (DHHS) Certification: Complies with 21 Center for Radiation (CFR) chapter 1 subchapter J applicable at time of manufacture.

Laser Safety: This unit employs a laser. Only a qualified service person should remove the cover or attempt to service this device, due to possible eye injury.

CAUTION: USE OF CONTROLS OR ADJUSTMENTS OR PERFORMANCE OF PROCEDURES OTHER THAN THOSE SPECIFIED HEREIN MAY RESULT IN HAZARDOUS RADIATION EXPOSURE.

CAUTION: VISIBLE AND INVISIBLE LASER RADIATION WHEN OPEN AND INTERLOCK DEFEATED. DO NOT STARE INTO BEAM. THE BEAM IS LOCATED INSIDE, NEAR THE DECK MECHANISM.

Special Information for Canadian Users: This Class B digital apparatus complies with Canadian ICES-003. Cet appareil numérique de la classe B est conforme à la norme NMB-003 du Canada.

Radio/TV Interference: This equipment has been tested and found to comply with the limits for a Class B digital device, pursuant to Part 15 of the FCC Rules. These limits are designed to provide reasonable protection against harmful interference in a residential installation. This equipment generates, uses, and can radiate radio frequency energy and, if not installed and used in accordance with the instructions, may cause harmful interference to radio communications. However, there is no guarantee that interference will not occur in a particular installation. If this equipment does cause harmful interference to radio or television reception, which can be determined by turning the equipment off and on, the user is encouraged to try to correct the interference by one or more of the following measures:

- 1) Reorient or relocate the receiving antenna.
- 2) Increase the separation between the equipment and the receiver.
- 3) Connect the equipment into an outlet on a circuit different from that to which the receiver is connected.
- 4) Consult the dealer or an experienced radio/TV technician for help.

Copyright Protection: Unauthorized copying, broadcasting, public performance and lending of Discs are prohibited. This product incorporates copyright protection technology that is protected by method claims of certain U.S. patents and other intellectual property rights owned by Macrovision Corporation and other rights owners. Use of this copyright protection technology must be authorized by Macrovision Corporation and is intended for home and other limited viewing uses only unless otherwise authorized by Macrovision Corporation. Reverse engineering or disassembly is prohibited.

Note to the Cable TV System Installer: This reminder is provided to call the Cable TV system installer's attention to Article 820-40 of the National Electrical Code, which provides guidelines for proper grounding – in particular, specifying that the cable ground shall be connected to the grounding system of the building, as close to the point of cable entry as possible.

Declaration of Conformity

Model Number: MRD500VR
 Trade Name: Magnavox
 Responsible Party: Philips Consumer Electronics
 P.O. Box 14810
 Knoxville, TN 37914-1810
 (865) 521-4316

Manufactured under license from Dolby Laboratories. "Dolby", "Pro Logic", and the double-D symbol are trademarks of Dolby Laboratories.

"DTS" and "DTS Digital Surround" are trademarks of Digital Theater Systems, Inc.
 Copyright 2003 Magnavox. All rights reserved.

4 Table of Contents

General Information

Safety and General Information	3
Table of Contents	4
Introduction	5
Playable Discs and Video Cassettes	6

Initial Setup

Hookups	7-15
Antenna Connections	16
Speaker Setup	17-18
Remote Control Setup	18
First-time Setup	19

Basic Playback

Video Cassette Playback	20
Disc Playback	21

Basic Controls

Remote Control	22-23
Front Panel	24-25
Display Panel	26
Rear Panel	27

Additional VCR Setup

Channel Setup	28-29
Clock (VCR)	30-31
Language (VCR)	32
VCR Status Displays	33

Videotape Recording Options

Videotape Recording	34
Recording One Channel/Watching Another	35
One-Touch Recording	36
Rerecording (Tape Duplication)	37
Timer Recording	38-40
DVD to Videotape Duplication	41

Videotape Playing Options

Repeat Play	42
Tape Counter	43
Time Search, Index Search	44
Special Effects Playback	45
Automatic Operation Features	46

Additional VCR Features

Multi-Channel Television Sound	47
Hi-Fi Stereo	48

Speaker and Sound Settings

Digital Sound, Surround Sound	49
DelayTime	50-51
Speaker Balance	52-53

Disc Playback Features

DVD Disc Menus	54
Fast Forward/Reverse Search	55
Title/Chapter Playback, Time Playback	56
Track Playback	57
Paused and Step-by-Step Playback, Resume	58
Repeat, A-B Repeat	59
Markers	60
Subtitles, Camera Angles	61
Slow Motion, Zoom	62
Programs, Random Play	63
Parental Controls Password	64
Parental Levels	65
Audio Language, Stereo Sound	66
MP3/JPEG/Picture CD Playback	67
MP3/JPEG/Picture CD Displays	68

DVD Player Setup Options

Display	69
Language	70-71
Audio	72
On-Screen Displays	73
Black Level	74

AM/FM Radio

Selecting Radio Stations	75
Preset Radio Stations	76

Information You May Need

Glossary, Specifications	77
Helpful Hints	78-81
Limited Warranty	82
Information Index	84

Introduction 5

Welcome!

This System combines a Digital Video Disc (DVD) Player, a Hi-Fi Video Cassette Recorder (VCR), and an AM/FM Radio Tuner into one unit, letting you play DVDs, Audio Compact Discs (Audio CDs), and Video Cassettes on one piece of equipment.

This DVD Digital Home Cinema System creates the same dynamic sound qualities that you find in cinemas and incorporates some of the best features in home theater technology.

Read this owner's manual carefully to learn how to use the features listed below.

VCR Features

- Automatic Head Cleaner
- Channel Setup
- English, French, and Spanish menus and displays
- Multi-Channel TV Sound
- 19 Micron head
- Recording: One-Touch and Timer
- Repeat Play
- Searching: Time, Index, Forward, and Reverse
- Slow Motion
- Still Picture
- Tape Counter
- Tracking Adjustment

Disc Features

- Audio Language choices*
- Bit Rate display
- Camera Angle *
- Dolby Digital Sound*
- DVD to Videotape Duplication
- Dynamic Range Control
- Fast/Paused/Slow/Step-by-Step Playback
- Markers
- Parental Controls*
- Program Playback
- Random Playback
- Repeat, Repeat A-B
- Screen Saver
- Search (Title/Chapter, Time, Track)
- Subtitles*
- Zoom

* If available on the DVD

AM/FM Radio Tuner Features

- FM/AM radio
- Preset programming of up to 40 radio stations

Package Contents

- The following items are provided with your new System.
- Remote Control and two AA batteries
 - One black RF coaxial cable, 75 ohm
 - AM Loop Antenna
 - FM Wire Antenna
 - One set of Audio (red and white tips) and Composite Video (yellow tips) cables
 - Speaker and Subwoofer Cables
 - Brackets and Screws
 - This Owner's Manual and Quick-Use Guide

DVD Disc Menus...

Some explanations in this manual describe DVD Disc menus. DVD manufacturers set the menus, which vary among DVDs. All DVDs do not have menus. If the DVD has a menu, access it by pressing DVD, then DISC/MENU on the remote control. *Details are on page 54.*

DVD Player Setup Menu...

Some instructions explain how to use the DVD Player's Setup menu to set up features of the DVD Player or a DVD. Access the DVD Player menu by pressing DVD, then SETUP/PROG on the remote control when playback is stopped. Even if a feature is set in the DVD Player's menu, it may not be available if the current DVD does not include that feature.

Available Disc Features...



All features described in this manual are not available on every Disc. If the feature is not available on the Disc, you cannot use the System to make it available. An "X" will appear in the top right corner of the TV screen if you try to access a feature that is not currently available.

6 Playable Discs and Video Cassettes

Playable Discs

The DVD Player will play Digital Video Discs (DVDs); Audio Compact Discs (CDs); Video CDs; finalized Digital Video Discs Rewritable (DVD+RW); and finalized Compact Discs Rewritable (CD-RW) and Compact Discs Recordable (CD-R), including Picture CDs.

To play a DVD, make sure it meets the requirements for Region Codes and Color Systems as described below. Discs that have the following logos will play on the DVD Player. Other Disc types are not guaranteed to play.



DVD



Video CD



Audio CD



CD-RW/CD-R



DVD+RW



Picture CD

Region Codes

This System has a Region One (1) DVD Player. DVDs must be labeled for ALL regions or for Region 1 in order to play on the DVD Player. You cannot play DVDs that are labeled for other regions. Look for the symbols below on your DVDs. If these region symbols do not appear on your DVD, you cannot play the DVD in this DVD Player.



The number inside the globe refers to a region of the world. Region 1 represents the United States, Canada, upper regions of North America, Bermuda, the U.S. Virgin Islands, and small regions near Australia. A DVD labelled for a specific region can only play on DVD Players with the same region code.

Color Systems

DVDs are recorded in different color systems throughout the world. The most common color systems are NTSC (which is used primarily in the United States and North America), PAL, and SECAM.

This DVD Player uses NTSC, so DVDs you play must be recorded in the NTSC system. You cannot play DVDs recorded in other formats. The color system of the DVD may be listed on the DVD or on the Disc case.

Playable Video Cassettes

The VCR of this System has a High Quality (HQ) system and is compatible with existing Video Home System (VHS) equipment. Use only video cassettes that have the **VHS** mark. The use of other tapes may result in poor picture quality and excessive deposits on the video heads, which may not be covered by the warranty if damage occurs.

The VCR also has a 19 micron head, which provides a better picture when you view tapes recorded in slow speed (SLP).

Kodak Picture CD

This product complies with the KODAK Picture CD format and will display KODAK Picture CDs. The "KODAK Picture CD Compatible" logo is a trademark of Eastman Kodak Company and is used with permission.

Hookups 7

Determining the best possible connection...

Your hookup will be determined by your existing equipment, especially your TV. These guidelines describe which options have the best picture (video) and sound (audio) quality. You will not use all the jacks on the System.

If your TV only has an RF-style jack, usually labelled Antenna In, RF In, or 75 ohm, use the System's TV ANTENNA OUT jack to connect to the TV. This hookup provides both audio and video in a single cable. Set your TV to channel 3 or 4 - the output channel of the System. This connection allows you to use both the DVD and VCR features. *Details are on page eight.*

- ★ ★ ★ ★ If your TV has Component Video In jacks (which could be labelled Y Cr Cb, Y Pr Pb, or YUV and may be green, blue, and red), use the COMPONENT VIDEO OUT jacks (Y Pb/Cb Pr/Cr) for the best picture quality.
If you use only this video connection, only the DVD picture will be available. To see DVD features on the TV, set the TV to its Component Video In channel. *Details are on page 12.*
- ★ ★ ★ If your TV has an S-Video In jack (which may be labelled Y/C or S-VHS), use the S-VIDEO OUT jack for excellent picture quality. If you use only this video connection, only the DVD picture will be available. To see DVD features on the TV, set the TV to its S-Video In channel. *Details are on page 13.*
- ★ ★ If your TV has a single yellow Video In jack (which may be labelled CVBS, Composite, or baseband), use the yellow VIDEO (DVD/VCR OUT) jack for good picture quality. This connection provides a picture for both the DVD Player and the VCR. Set the TV to its Video In channel.
Details are on page 11.
- ★ ★ ★ If you have a Stereo with a Coaxial Digital Audio In jack, this provides the clearest sound for the DVD Player. Connect the System's DIGITAL AUDIO OUT COAXIAL jack to your Stereo. If you use only this audio connection, only Disc sound (no VCR) will be available. *Details are on page 15.*
- ★ ★ ★ ★ If digital audio connections are not possible, connect the System's red and white AUDIO (DVD/VCR OUT) jacks to the Audio In jacks of your Stereo or TV. This provides sound for both the DVD Player and the VCR. *Details are on pages 11-14.*

Before you begin...

- Refer to the manuals of your TV, Cable Box, Stereo, or other devices as necessary. Note the style of jacks and connectors on the other equipment. Determine how to choose different Audio and Video In channels on your other equipment so you can see and hear the System playing on the TV, Stereo, etc.
- Disconnect all equipment from the power outlets. Connect the equipment to the power outlets only after you have finished hooking up everything. Never make or change connections with equipment connected to the power outlet.

Remember...

- Set the TV to the correct Video In channel. Such channels may be called AUX or AUXILIARY IN, AUDIO/VIDEO or A/V IN, EXT1 or External In, etc. These channels often are located near channel zero. See your TV owner's manual for details. If you do not see the DVD or VCR playback on the TV, go to the lowest TV channel (01 or 02) and change channels downward until you see the DVD or VCR picture on the TV. Or, if your TV has only a single Antenna In jack and you are using the RF coaxial cable (as described on page eight), set the TV to channel 3 or 4.
To find the right Audio/Video In channel, turn on the System. Press DVD to put the System in DVD mode. With no Disc in the Player, a large DVD logo will appear on the TV screen when you get the TV on the correct Audio/Video In channel or channel 3 or 4.
- Set a separate Stereo (if applicable) to the correct channel or "source" mode.
- Depending on your connection, you may need to purchase additional cables or adaptors.
- **To use the VCR features, you must include a connection with the supplied yellow video cable and red/white audio cables or with the supplied RF coaxial cable.**

Once you determine the best option, find your choice on pages 8-15. Follow the specific steps for the hookup you choose.

8 Hookups (cont'd)

System to TV only

Simplest connection using only the supplied black RF coaxial cable
This connection will let you use the features of both the VCR and the DVD Player.

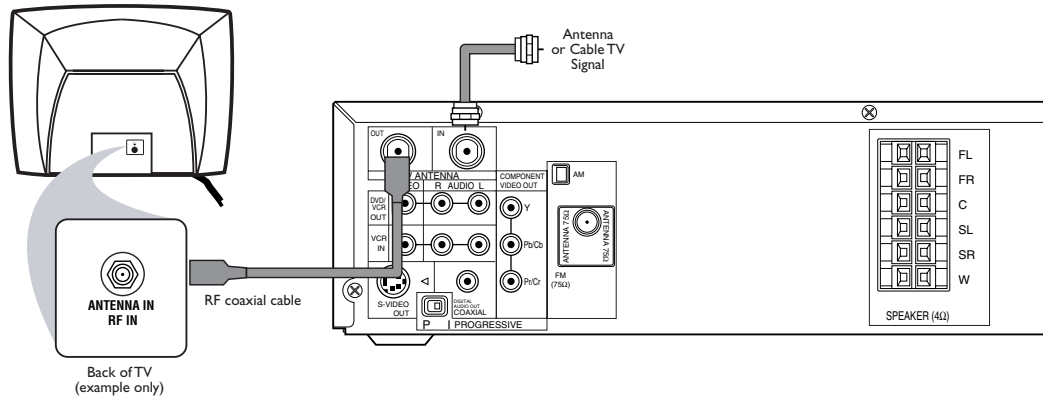

- 1** Disconnect the antenna or Cable TV signal from your TV and connect it to the TV **ANTENNA IN** jack on the System.
- 2** Connect the supplied black RF coaxial cable to the System's TV **ANTENNA OUT** jack and to the **Antenna In** jack on the TV. The ANTENNA IN jack on the TV may be labelled TV IN, RF IN, 75Ω (ohm), or ANT. IN. See your TV owner's manual for assistance.
- 3** Set the **P/I PROGRESSIVE** switch on the rear of the System to **I (Interlace)**.
- 4** You are ready to connect the **AM** and **FM** antennas and the **Speakers**. See pages 16-17 to connect these items.
- 5** When all connections are complete, plug in the power cords of the TV and the System.
- 6** Set your TV to channel 3 or 4. The System's output channel is 3 when you purchase it. So, set your TV to channel 3 when the System is new.
If you cannot use channel 3 at your TV, you can change the System's output channel to channel 4. To do so, press the VCR button to put the System in VCR mode. The red VCR light will be on the front of the System. Insert a videotape and press **PLAY ►** to start playback. (You cannot change the System's output channel when you adjust the tracking manually. In this case, press **STOP ■** to stop the playback once. Then, press **PLAY ►** to start playback again.)
During playback, press and hold the (VCR) PLAY ► button on the front of the System for three to five seconds. Each time you do this, the System's output channel switches between 3 and 4. Change your TV to channel 3 or 4 accordingly.
There is not a channel 3/4 switch on the System (as customary with most VCRs).
- 7** If you have not turned on the System already, go to page 19 to complete the VCR's **First-Time Setup**. This process sets up the TV channels and the language for the VCR menu.

Hookups (cont'd) 9

Connecting the Cable Box/Satellite Receiver to the System and to a TV

This connection will let you use the features of both the VCR and the DVD Player.

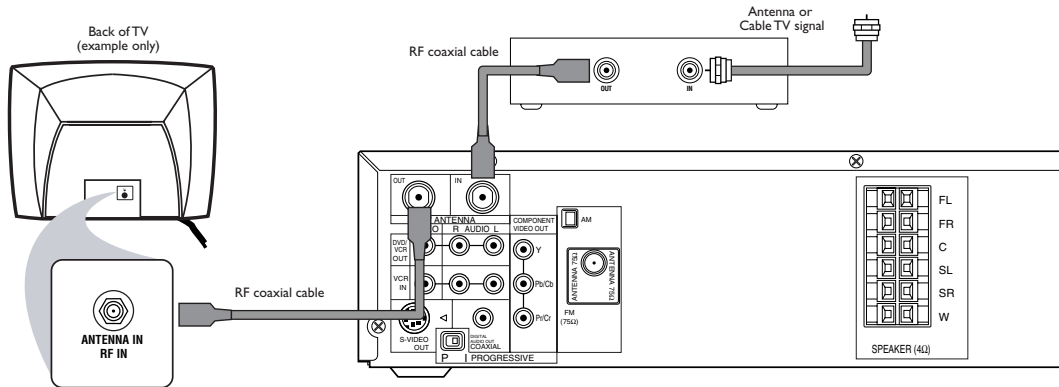

- 1** Connect a Cable TV or Satellite signal to the **IN** jack on the Cable Box/Satellite Receiver.
- 2** Use an RF coaxial cable to connect the **OUT** Jack on the Cable Box/Satellite Receiver to the System's **TV ANTENNA IN** jack.
- 3** Use a second RF coaxial cable (one is supplied) to connect the System's **TV ANTENNA OUT** jack to the TV's Antenna In jack.
- 4** Set the **P/I PROGRESSIVE** switch on the rear of the System to **I** (Interlace).
- 5** You are ready to connect the **AM** and **FM** antennas and the **Speakers**. Go to pages **16-17** to connect these items.
- 6** When all connections are complete, plug in the power cords of the **TV**, **Cable Box/Satellite Receiver**, and the **System**.
- 7** Set your **TV** to **channel 3**. If you cannot use channel 3 at your TV, you can change the System's output channel to channel 4. See step 6 on page eight for details.
- 8** If you have not turned on the System already, go to page **19** to complete the **VCR's First-Time Setup**.

With this connection . . .

- Select TV channels at the Cable Box/Satellite Receiver, not the System. To record or view TV channels:
 - 1) Press **VCR** to put the System in VCR mode. The red VCR light will appear on the front of the System.
 - 2) Press **SKIP ►►/CH ▲** or **SKIP ◄◄/CH ▼** to set the System to the Cable Box/Satellite Receiver output channel (03 or 04).
 - 3) Set the TV to the System's output channel (03 or 04).
 - 4) Select the channel you want to view/record at the Cable Box/Satellite Receiver.
- You may not view a channel other than the one you are recording.
- Program a timer recording for one channel at a time. Set your Cable Box/Satellite Receiver to the channel you want to record. When you enter the channel you want to record in a timer recording, select channel 03 or 04 (the Cable Box/Satellite Receiver output channel). (This is step 8 on page 39.) Leave the Cable Box/Satellite Receiver on for a timer recording.

Helpful Hint

- If your Cable Box/Satellite Receiver has Audio/Video Out jacks, use audio/video cables to connect them to the **AUDIO** and **VIDEO (VCR IN)** jacks on the System. You will not need the RF coaxial cable as described at step 2.

10 Hookups (cont'd)

System to Cable Box/Satellite Receiver and TV

This connection will let you use the features of both the VCR and the DVD Player.

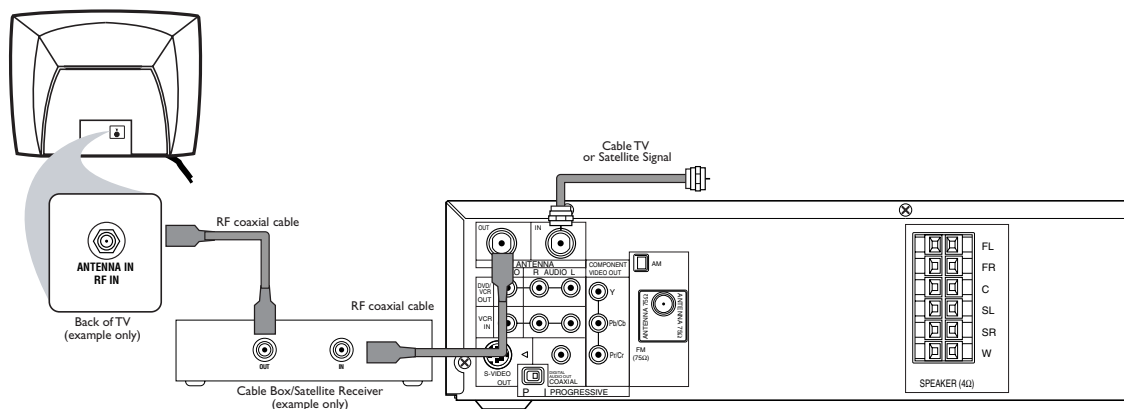

- 1** Connect the Cable TV or Satellite signal to the System's TV ANTENNA IN jack.
- 2** Connect an RF coaxial cable to the System's TV ANTENNA OUT jack and to the IN jack on the Cable Box/Satellite Receiver.
- 3** Connect another RF coaxial cable to the OUT jack on the Cable Box/Satellite Receiver and to the ANTENNA IN jack on the TV.
- 4** Set the P/I PROGRESSIVE switch on the rear of the System to I (Interlace).
- 5** You are ready to connect the AM and FM antennas and the Speakers. Go to pages 16-17 to connect these items.
- 6** When all connections are complete, plug in the power cords of all equipment. Set the Cable Box/Satellite Receiver to channel 3 (the System's default output channel). Set the TV to the Cable Box/Satellite Receiver's output channel (03 or 04).
- 7** If you have not turned on the System already, go to page 19 to complete the VCR's First-Time Setup. This process sets the TV channels and the language for the VCR menu.

To watch one channel while recording another ...

- 1) Put the Cable Box/Satellite Receiver on channel 3 (the System's default output channel). (To change it to 4, press and hold (VCR) PLAY ► on the front of the System for 3-5 seconds during tape playback. *Details are on page eight.*) Set the TV to the Cable Box/Satellite Receiver output channel (03 or 04).
- 2) Press VCR to put the System in VCR mode. The red VCR light will appear on the front of the System.
- 3) Press VCR/TV on the remote to choose VCR position.
- 4) Press SKIP ►► /CH ▲ or SKIP I◄◄ /CH ▼ to select the channel you want to record at the System. Press REC ● or RECORD ● to start the recording.
- 5) Press VCR/TV on the remote once to put the System in TV position.
- 6) Select the channel you want to watch at the Cable Box/Satellite Receiver.

Hookups (cont'd) 11

Connecting the System to a TV that has Audio and Video In jacks

This connection will let you use the features of both the VCR and the DVD Player.

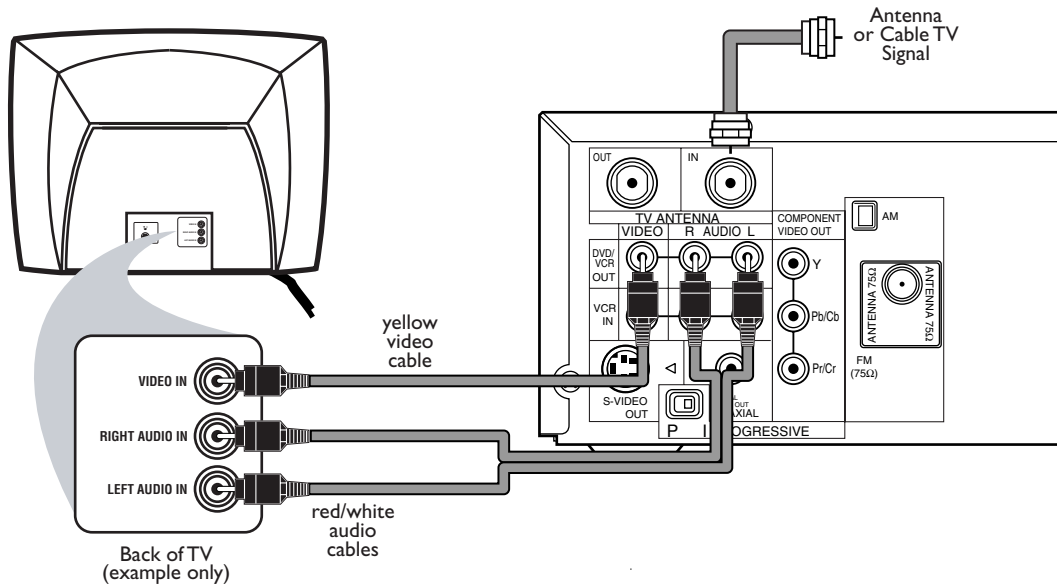

- 1** Connect the antenna or Cable TV signal to the System's TV ANTENNA IN jack.
- 2** Connect the red and white audio cables (supplied) to the red and white AUDIO (DVD/VCR OUT) jacks on the System and to the red and white AUDIO IN jacks on the TV. Match the cable colors to the jack colors. If the TV has a single AUDIO IN jack, use the white audio cable to connect the System's white AUDIO L (left) (DVD/VCR OUT) jack to the TV's AUDIO IN jack. You will not use the red cable.
- 3** Connect the yellow video cable (supplied) to the System's yellow VIDEO (DVD/VCR OUT) jack and to the VIDEO IN jack on the TV. The VIDEO IN jack on the TV is usually yellow and may be labelled CVBS, Composite, or Baseband video.
- 4** Set the P/I PROGRESSIVE switch on the rear of the System to I (Interlace).
- 5** You are ready to connect the AM and FM antennas and the Speakers. Go to pages 16-17 to connect these items.
- 6** When all connections are complete, connect the power cords of the TV and the System to a power outlet. Turn on the TV and set it to the Audio/Video In channel. To find the right Audio/Video In channel, turn on the System. Press DVD to put the System in DVD mode. With no Disc in the Player, a large DVD logo will appear on the TV screen when you get the TV on the correct Audio/Video In channel. Go to your lowest TV channel (01 or 02), then change channels down until you see the DVD logo.
- 7** If you have not turned on the System already, go to page 19 to complete the VCR's First-Time Setup. This process sets up the TV channels and the language for the VCR menu.

12 Hookups (cont'd)

Connecting the System to a TV that has Component Video In jacks

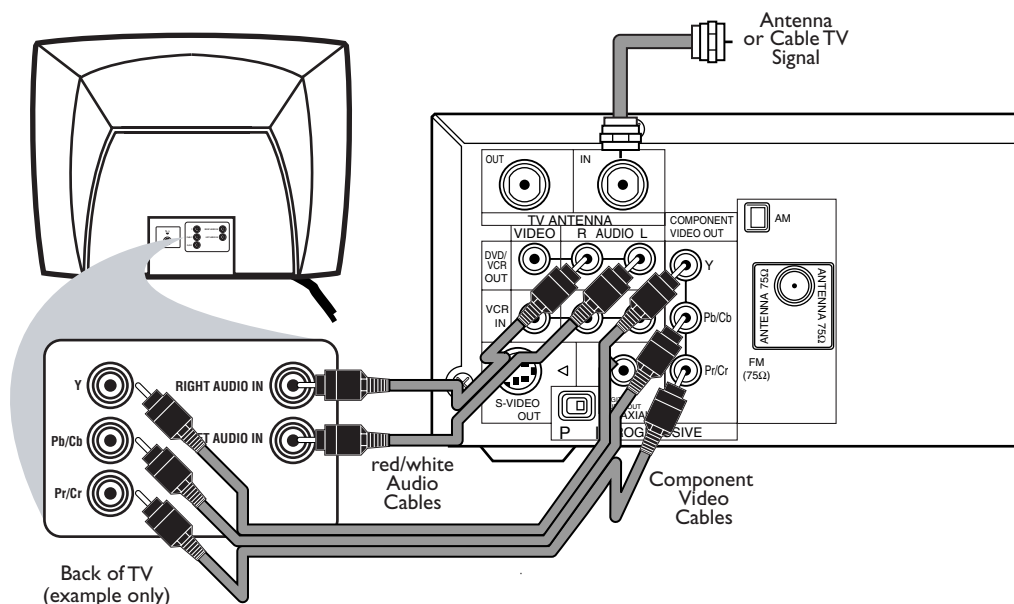

- 1** Connect the antenna or Cable TV signal to the System's **TV ANTENNA IN** jack.
- 2** Connect the supplied red/white audio cables to the System's red/white **AUDIO (DVD/VCR OUT)** jacks and to the TV's **AUDIO IN** jacks. Match cable colors to jack colors.
- 3** Connect component video cable to the System's **COMPONENT VIDEO OUT (Y Pb/Cb Pr/Cr)** jacks and to the **COMPONENT VIDEO IN** jacks on the TV. Component Video In jacks on the TV are usually red, blue, and green.
The Component Video connection only supplies video (picture) for the DVD Player of the System. To use the VCR or see TV channels, you must connect the RF coaxial cable or the yellow video cable. To connect the RF coaxial cable, see step 2 on page eight. To connect the yellow video cable, see step 3 on page 11. If you are using the RF coaxial cable for VCR playback, choose channel 3 or 4 at the TV. If you are using the yellow video cable for VCR playback, choose the Video In channel at your TV.
- 4** Set the **P/I PROGRESSIVE** switch on the rear of the System to **I (Interlace)**. Or, if your TV has Progressive Scan, set the **P/I PROGRESSIVE** switch to **P (Progressive)**.
- 5** You are ready to connect the **AM** and **FM** antennas and the **Speakers**. Go to pages **16-17** to connect these items.
- 6** When all connections are complete, connect the power cords of the System and TV to a power outlet. Turn on the TV and set it to the **Component Video In** channel for **DVD Player** features. To help you find the Component Video In channel, turn on the System. Press **DVD** to put the System in DVD mode. With no Disc in the Player, a large DVD logo will appear on the TV screen when you get the TV on the correct Component Video In channel. Go to your lowest TV channel (01 or 02) and change channels down until you see the DVD logo on the TV screen.
- 7** If you have not turned on the System already, go to page **19** to complete the **VCR's First-Time Setup**. This process sets up the TV channels and the language for the VCR menu.
- 8** Set **DOLBY DIGITAL** to **OFF** in the **DVD Player's Setup** menu. Details are on page **72**. Playing a DVD when the settings are wrong could distort the sound or damage the speakers.

Hookups (cont'd) 13

Connecting the System to a TV that has an S-Video In jack

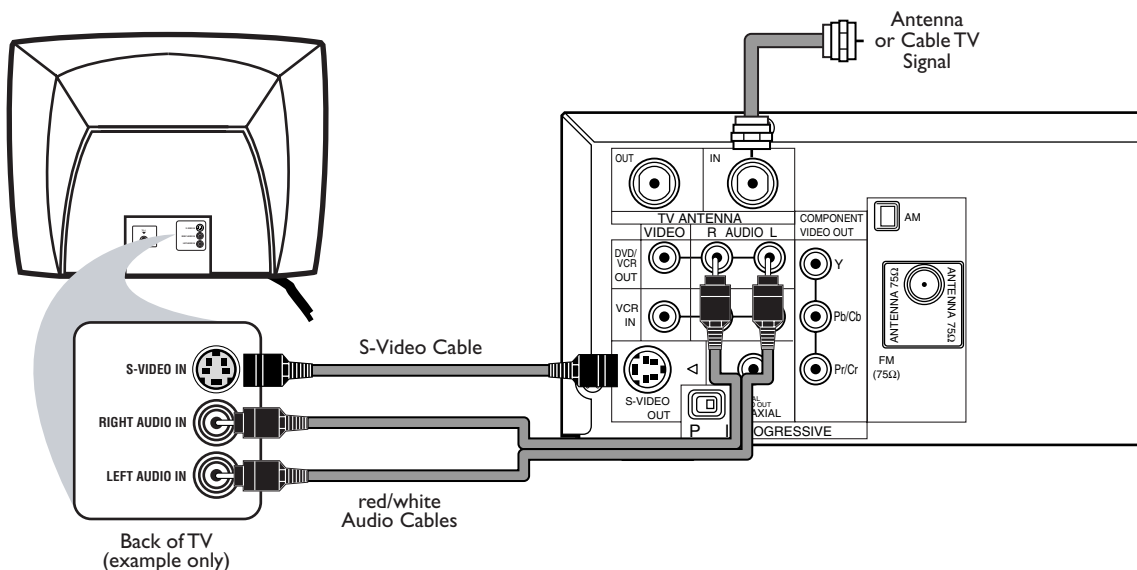

- 1** Connect the antenna or Cable TV signal to the System's TV ANTENNA IN jack.
- 2** Connect the supplied red/white audio cables to the System's red/white AUDIO (DVD/VCR OUT) jacks and to the TV's AUDIO IN jacks. Match cable colors to jack colors.
- 3** Connect an S-Video cable to the System's S-VIDEO OUT jack and to the S-VIDEO IN jack on the TV. S-Video only supplies a DVD picture. To use the VCR or view TV channels, connect the RF coaxial cable or the yellow video cable. To use the RF coaxial cable, see step 2 on page eight. To use the yellow video cable, see step 3 on page 11. If you are using the RF coaxial cable for VCR playback, choose channel 3 or 4 at the TV. If you are using the yellow video cable, choose the Video In channel at your TV.
- 4** Set the P/I PROGRESSIVE switch on the rear of the System to I (Interlace).
- 5** You are ready to connect the AM and FM antennas and the Speakers. Go to pages 16-17 to connect these items.
- 6** When all connections are complete, connect the power cords of the System and TV to a power outlet. Turn on the TV and set it to the S-Video In channel for DVD Player features. To help you find the right S-Video In channel, turn on the System. Press DVD to put the System in DVD mode. With no Disc in the Player, a large DVD logo will appear on the TV screen when you get the TV on the S-Video In channel. Go to your lowest TV channel (01 or 02) and change channels down until you see the DVD logo on the TV screen.
- 7** If you have not turned on the System already, go to page 19 to complete the VCR's First-Time Setup. This process sets up the TV channels and the language for the VCR menu.
- 8** Set DOLBY DIGITAL to OFF in the DVD Player's Setup menu. Details are on page 72. Playing a DVD when the settings are wrong could distort the sound or damage the speakers.

14 Hookups (cont'd)

Connecting the System to a TV and a Stereo

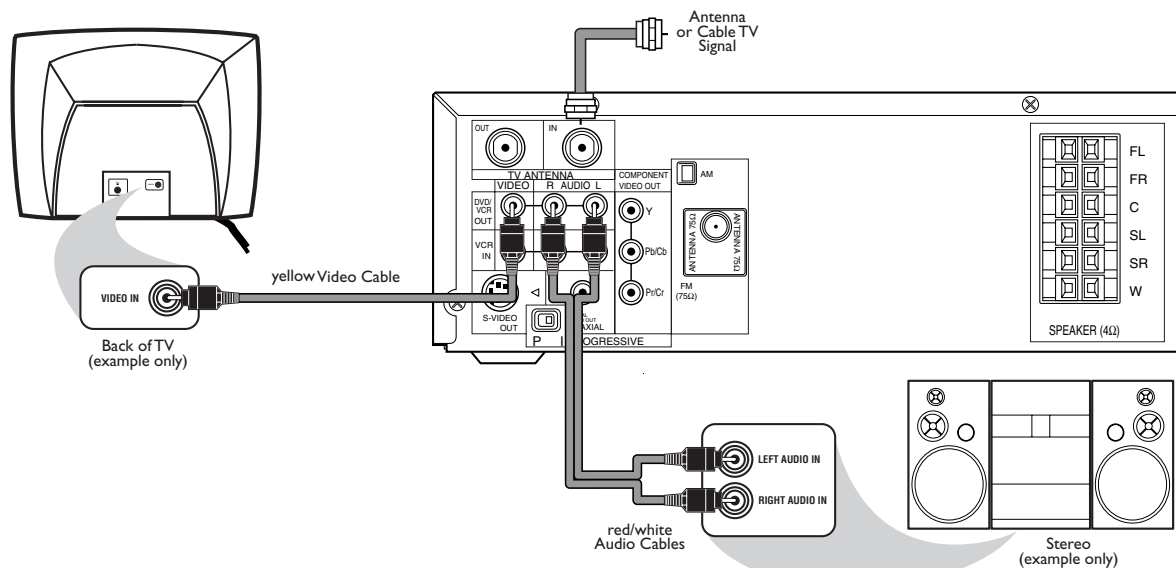

- 1** Connect the antenna or Cable TV signal to the System's TV ANTENNA IN jack.
- 2** Connect the red/white audio cables to the System's red/white AUDIO (DVD/VCR OUT) jacks and to the Stereo's red/white AUDIO IN jacks. Match cable colors to jack colors.
- 3** Connect the yellow video cable to the System's VIDEO (DVD/VCR OUT) jack and to the TV's VIDEO IN jack. To use Component Video cable or S-Video cable instead for the DVD Player, see pages 12-13. You still need the yellow video cable or RF coaxial cable for VCR features.
- 4** Set the P/I PROGRESSIVE switch on the rear of the System to I (Interlace).
- 5** You are ready to connect the AM and FM antennas and the Speakers. Go to pages 16-17 to connect these items.
- 6** After everything is connected, connect the power cords of the System, TV, and Stereo to a power outlet. Turn on the TV and set it to the Video In channel. Go to your TV's lowest channel (01 or 02) and change channels downward until you find the Video In channel. To find the right Video In channel at the TV, turn on the System. Press DVD to put the System in DVD mode. With no Disc in the Player, a large DVD logo will appear on the TV screen when you get the TV on the correct Video In channel.
- 7** If you have not turned on the System already, go to page 19 to complete the VCR's First-Time Setup. This process sets up the TV channels and the language for the VCR menu.
- 8** Set DOLBY DIGITAL to OFF in the DVD Player's Setup menu. Details are on page 72. Playing a DVD when the settings are wrong could distort the sound or damage the speakers.

Hookups (cont'd) 15

Connecting the System to a TV and a Dolby Digital-compatible Stereo Use Digital Audio connections

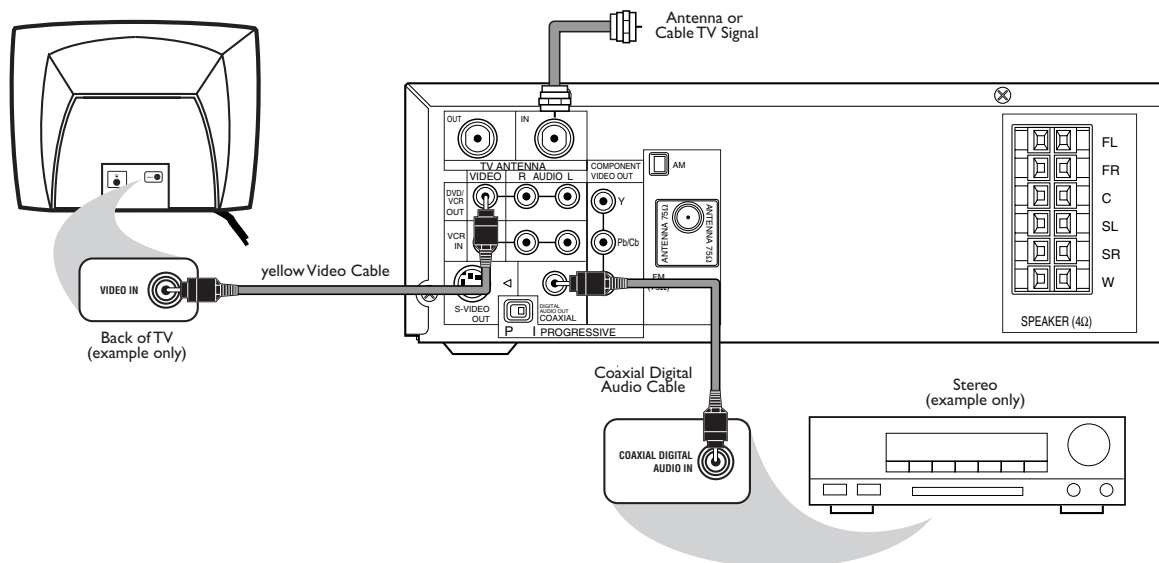

- 1** Connect the antenna or Cable TV signal to the System's TV ANTENNA IN jack.
- 2** Connect a coaxial digital audio cable (not supplied) to the System's DIGITAL AUDIO OUT COAXIAL jack and to the COAXIAL DIGITAL AUDIO IN jack on the Stereo. This digital audio connection only provides DVD sound. To use the VCR or view TV channels, connect the RF coaxial cable or the red/white audio cables. To connect the RF coaxial cable, see step 2 on page eight. To connect the audio cables, see step 2 on page 11.
- 3** Connect the yellow video cable to the System's yellow VIDEO (DVD/VCR OUT) jack and to the TV's VIDEO IN jack. To use component video cable or S-Video cable instead for the DVD Player, see pages 12-13. You need the yellow video cable or RF coaxial cable for VCR features.
- 4** Set the P/I PROGRESSIVE switch on the rear of the System to I (Interlace).
- 5** You are ready to connect the AM and FM antennas and the Speakers. Go to pages 16-17 to connect these items.
- 6** After everything is connected, plug in the power cords of the Stereo, TV, and System. Turn on the Stereo and select its Auxiliary IN channel. Turn on the TV and set it to the Video In channel. To find the right Video In channel on the TV, turn on the System. Press DVD to put the System in DVD mode. With no Disc in the Player, a large DVD logo will appear on the TV screen when you get the TV on the correct Video In channel. Go to your TV's lowest channel (01 or 02) and change channels downward until you see the DVD logo.
- 7** If you have not turned on the System already, go to page 19 to complete the VCR's First-Time Setup. This process sets up the TV channels and the language for the VCR menu.

Remember...

Some DVDs are recorded in 5.1 channel Dolby Digital Surround. Select 5.1 channel Dolby Digital Surround Sound in the DVD Disc menu. If Dolby Digital Surround is not recorded on the Disc, you will not have surround sound.

If your Stereo is Dolby-Digital compatible, set DOLBY DIGITAL to ON at the DVD Player. Details are on page 72. Otherwise, set DOLBY DIGITAL to OFF. Incorrect settings could distort the sound or damage the speakers.

16 Antenna Connections

AM Antenna

- 1 Fix the antenna holder as shown.

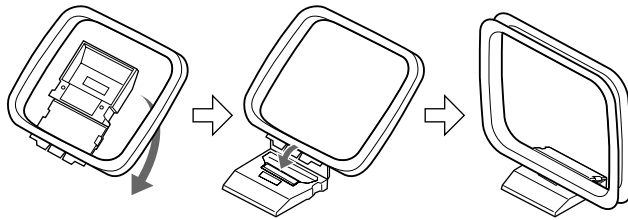

- 2 Connect the supplied AM antenna to the AM jack, then position it to receive the clearest sound.

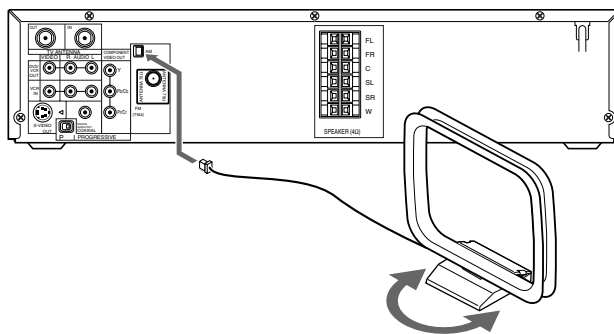

FM Antenna

- 1 Connect the supplied FM antenna to the FM jack. Extend the FM antenna wire and fix its end to the wall.

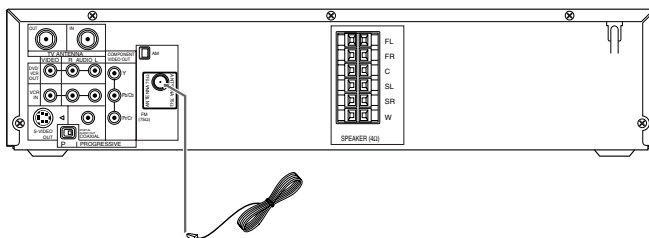

Helpful Hints

- Do not place the AM antenna on the System. Keep it as far as possible from the System and the speaker wires. Keep it away from the AC power cords of the System and other equipment.
- For better FM reception, connect an outdoor FM antenna (not supplied) to the ANTENNA 75 ohm jack.

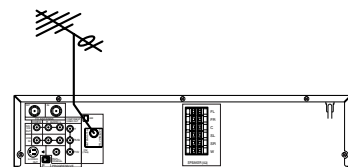

Connecting the speaker wires to the speaker jacks

- 1 Connect the supplied speakers using the supplied speaker wires. Match the colors of the wires to the colors on the jacks.
Hold down the jack tab while inserting the stripped portion of the speaker wire into the jack. Then, release the tab. Make sure you do not insert the wire too far. None of the rubber-coated wire should be clamped by the jack tab.

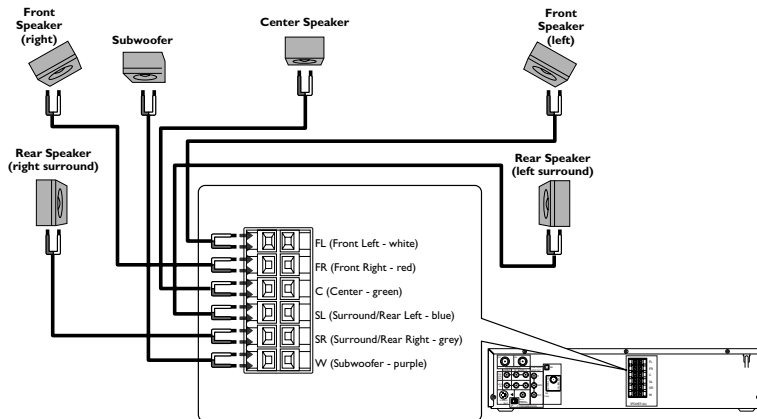
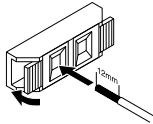

Setting up Surround Sound

Connect all the speakers and set up the System properly in order to enjoy the Home Cinema experience.

- 1 Place the FRONT Left and Right speakers at equal distances from the TV and at a 45-degree angle from the listening position.
- 2 Place the CENTER speaker above or below the TV to localize the sound.
- 3 Place the REAR (Surround) speakers at normal listening ear level, facing each other or mounted on the wall. Use the supplied mounting brackets to mount speakers to the wall.
- 4 Place the Subwoofer on the floor, near the TV.

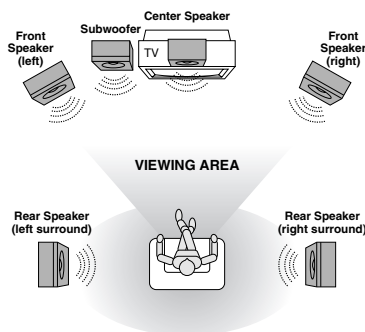

Helpful Hints

- Connect the speaker wires correctly. Improper connections may short circuit the System.
- For optimal sound, use the supplied speakers.
- Do not connect more than one speaker to any pair of speaker jacks on the System.
- Do not connect speakers with an impedance lower than 6 ohms.
- Sit in your usual listening position to set up the speaker balance. Details are on pages 52-53.
- To avoid magnetic interference, do not place the FRONT speakers too close to your TV.
- Placing the REAR (Surround) speakers farther from the listening position than the FRONT and CENTER speakers will weaken the Surround Sound effect.
- Secure all speakers to prevent accidents and improve sound quality. Use the supplied mounting brackets to mount speakers to a wall. Details are on page 18.

18 Speaker Setup (cont'd), Remote Control Setup

Speaker setup

You can hang the front, center and rear (Surround) speakers on a wall. Each speaker needs one screw (not supplied) for mounting. Use the type and size of screw as shown at right.

- 1 Attach a supplied bracket to the back of each speaker with one of the supplied screws.**
- 2 Drive a screw into the wall.** Make sure the screw and the wall can support 11 lbs. (5 Kg.). Drive the screw until the screw head extends about 0.1" (3.5 mm) from the wall.
- 3 Hook the slot in the speaker's bracket onto the wall-mounted screw.**

Caution

- Check the stability of the ceiling or wall. Magnavox is not liable for accidents caused by insufficient stability of the ceiling or wall or for improper mounting.
- The speaker may fall due to unstable mounting.
- If you need assistance, contact Magnavox.
- Do not modify or change the fittings of the supplied speakers, mounting brackets, and screws. Use these brackets to mount the supplied speakers only. Do not load anything else on these fittings.
- Do not step on or hang from the speakers. Pay special attention to small children to ensure their safety.

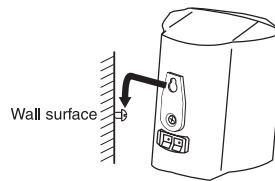
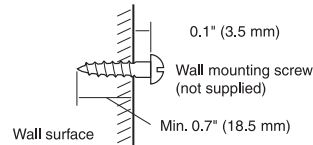
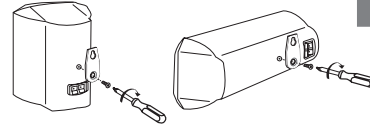
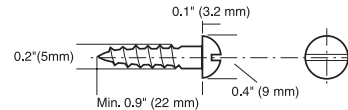

Putting Batteries in the Remote Control

- 1 Remove the battery compartment lid** on the bottom of the remote control by pressing the tab, then lifting the lid.
- 2 Place two AA batteries inside the battery compartment** with their + and - ends aligned as indicated.
- 3 Replace the battery compartment lid.**

Using the Remote Control

- Point the remote control at the System's remote sensor (marked IR, see page 24) when using the remote to operate the System. Do not point the remote at the TV.
- Do not put objects between the remote and the System.

Recycling Guidelines/Battery Safety

- Your new product and its packaging contain materials that can be recycled and reused. Specialized companies can recycle your product to increase the amount that needs to be properly disposed. Your product uses batteries that should not be thrown away when depleted but should be disposed of as small chemical waste. Please find out about the local regulations on disposal of your old product, batteries, and packaging whenever you replace existing equipment.
- **Battery Usage CAUTION** - To prevent battery leakage that may result in bodily injury, property damage, or damage to the unit: Install ALL batteries correctly, with the + and - markings on the battery aligned as indicated on the unit; Do not mix batteries, for example, old with new or carbon with alkaline; and Remove batteries when the unit will not be used for a long time.

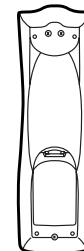
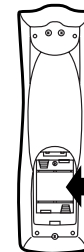
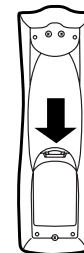

First-time Setup 19

Before turning on your System, make sure batteries are in the remote control and the TV and System are connected correctly. You cannot program TV channels at the System if you are using a Cable Box or a Satellite Receiver. You will change channels at the Cable Box/Satellite Receiver.

- 1 Turn on the TV. Set it to channel 3 or 4 or its AUDIO/VIDEO IN channel, depending on how you connected the System to a TV.**
- 2 Press **STANDBY-ON**  to turn on the System, then press **VCR**. The red VCR light and the red STANDBY-ON light will appear on the front of the System. This display will appear:**

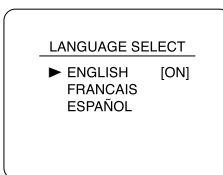

These menus may not appear if you have already turned on the System (to find the Audio/Video In channel of the TV, for example). Follow the steps on page 28 to set up TV channels and page 32 to select a language for the VCR menus.

- 3 Press **▲** or **▼** to select English, French, or Spanish as the language for VCR on-screen displays and menus. Then, press **▶**.**



- 4 Press **▶** to begin channel programming.** AUTO SET UP will flash on the TV screen during the channel search. The System will memorize all available channels. When channel programming is complete, the lowest available channel will appear on the TV. These channels will be available when you want to watch TV while the System is in VCR mode. To put the System in VCR mode, press VCR so the red VCR light appears. Use the SKIP **▶▶** /CH **▲** and SKIP **◀◀** /CH **▼** buttons to select memorized channels. To select non-memorized channels, use the Number buttons.

- 1 Turn on the TV.**

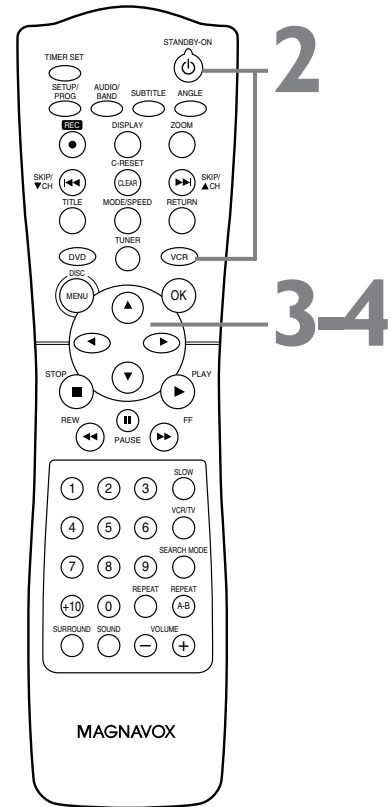

Helpful Hints

- To skip this feature and play a tape immediately, insert a tape with its record tab removed.
- To skip step 3, press **DISC/MENU**. VCR menus and displays will be in English.
- If you try to program channels when there is no antenna or Cable TV signal connected to the System's TV ANTENNA IN jack, programming will stop. AUTO SET UP will stop flashing. Connect an antenna or Cable TV signal to the System's TV ANTENNA IN jack and press **▶** again.
- Repeat this process if the power fails for more than 30 seconds.
- To stop the Channel Setup while AUTO SET UP is flashing, press **DISC/MENU**.

20 Video Cassette Playback

Read and follow the steps below to play a tape.

- 1 Turn on the TV. Set it to channel 3 or 4 or its AUDIO/VIDEO IN channel.** This depends on how you connected the System to a TV. *Details are on pages 8-11.*
- 2 With the System's power off, insert a tape in the cassette compartment.** The STANDBY-ON and VCR lights will appear on the front of the System. If the tape's record tab has been removed, playback will start automatically. Or, if the System's power is already on, press VCR to put the System in VCR mode. The red VCR light will appear on the front of the System.
- 3 If play does not start automatically, press VCR, then press PLAY ►.**
- 4 Press STOP ■ to stop playback.**
- 5 Press REW ◀◀ to rewind the tape.**
- 6 After the tape stops, press STOP/EJECT ■▲ on the front of the System to remove the tape.**

- 1** Turn on the TV.
- 2** Insert a tape in the System.

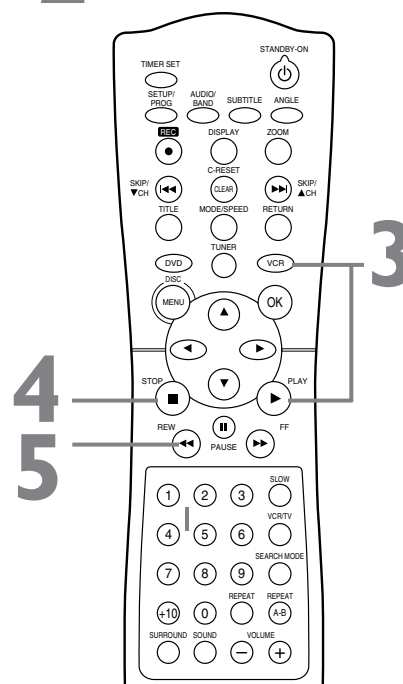







- 6** Press STOP/EJECT ■▲ on the System.

Helpful Hints

- Other tape playback features are on pages 42-46.
- If AUTO REPEAT is ON, playback will begin when you insert a tape, even when the record tab is intact. *Details are on page 42.*
- You must connect the System to a TV using the RF coaxial cable or the audio/video cables in order to use the VCR features. These hookups are explained on pages eight and 11.
- You cannot use the VCR when the System is in Tuner mode. If you fast forward, rewind, or eject a videotape, you may hear noise through the speakers or some displays may be incorrect.
- You cannot use the Tuner when the System is in VCR mode. Make sure you stop tape play before putting the System in Tuner mode.

Disc Playback 21

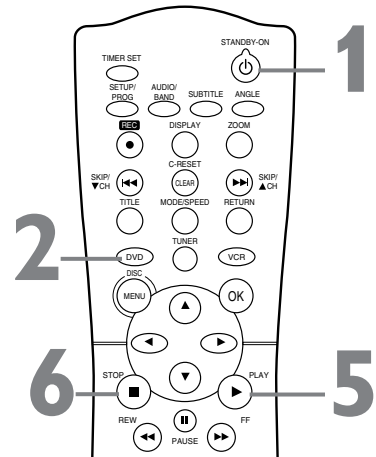

Before you begin, turn on the TV and set it to the correct Video In channel. Details are on pages 7-15.

- 1** Press **STANDBY-ON**  to turn on the System.
- 2** Press **DVD** so the red DVD light appears on the front of the System.
- 3** Press **OPEN/CLOSE**  (to the right of the disc tray on the front of the System) to open the Disc tray.
- 4** Place a Disc into the tray. If the DVD is recorded on only one side, place the Disc in the tray with the label facing up and the shiny side facing down. Some DVDs are recorded on both sides. Make sure the label of the side you want to play is facing up.
- 5** Press **PLAY** . The tray will close and play will begin. If a DVD menu appears instead, see page 54. With some Audio CDs, play will not begin unless you press **PLAY** . You also can press **OPEN/CLOSE**  or press the tray toward the System to close the tray.
- 6** Press **STOP**  to stop playback.



- 3** Press **OPEN/CLOSE**  on the front of the System.
- 4** Insert a Disc.

Helpful Hints

- An "X" may appear at the top right corner of the TV screen when you try a feature. Either the feature is not available on the Disc, or the System cannot access the feature at this time. This does not indicate a problem with the System.
- If a Disc is dirty or scratched, the picture may appear distorted or play may stop. Remove the Disc and turn off the System. Disconnect the power cord, then reconnect it. Clean the Disc, then turn on the System again and reinsert the Disc. You may need to repeat the System's setup because of the temporary power loss.
- When the DVD or CD light appears on the display panel, the Disc is loaded and ready to play.
- When you press **OPEN/CLOSE**  or **PLAY**  (DVD) on the front of the System when the power is off, the System will turn on in DVD mode. Otherwise, the System will turn on in the mode in which it was turned off.
- Do not use the DVD Player features when the System is in Tuner mode. You may hear noises through the speakers or the displays may be incorrect.

Remember, the DVD Player of this System will play only certain Discs. See page six for details.

22 Remote Control

AUDIO/BAND Button

Press to choose a DVD audio language or an Audio CD sound mode. *Details are on page 66.*
Press to choose FM or AM in Tuner mode. *Details are on page 75.*

SETUP/PROG Button

Press while play is stopped to access the DVD Player's Setup menu. Press to preset radio stations in Tuner mode. *Details are on page 76.*

DISPLAY Button

Press to see status displays. *Details are on pages 33 and 73.*

TITLE Button

Press to see a DVD Title menu. *Details are on page 54.*

DVD Button

Press before using the remote control for DVD features. Press to put the System in DVD mode.

◀▶▲▼ Buttons

Press to select an item in a menu. In Tuner mode, press ◀ or ▶ to choose a preset radio station.

REW ◀◀ (rewind) Button

Press to fast reverse a DVD or Audio CD. *Details are on page 55.*
Press to rewind a tape. *Details are on page 45.*

SURROUND Button

Press to turn Surround Sound on or off. *Details are on page 49.*

SOUND Button

Press to choose a Digital Sound effect. *Details are on page 49.*

REPEAT Button

Press to play a Track, Audio CD, Title, or Chapter repeatedly. *Details are on page 59.*

SUBTITLE Button

Press to select a language for DVD subtitles. *Details are on page 61.*

ANGLE Button

Press to see a DVD picture from a different angle. *Details are on page 61.*

ZOOM Button

Press to enlarge the DVD, JPEG, or Picture CD image. *Details are on page 62.*

C-RESET/CLEAR Button

Press to remove VCR menus. Press to reset the tape counter. *Details are on page 43.*
Press to clear a menu setting.

TUNER Button

Press before using the remote control for Tuner features. Press to put the System in Tuner mode.

OK Button

Press to confirm or select menu items.

PLAY ▶ Button

Press to begin Disc or tape playback.

PAUSE || Button

Press to pause Disc playback or to advance the picture one frame at a time. *Details are on page 58.* Press to pause or resume VCR recording. *Details are on page 34.* Press to pause a tape. *Details are on page 45.*

SLOW Button

Press to view a videotape in slow motion. *Details are on page 45.*

SEARCH MODE Button

In DVD mode, press to search for a specific Title/Chapter/Track/Time. *Details are on pages 56-57.* In VCR mode, press for a Time Search or an Index Search. *Details are on page 44.*

A-B REPEAT Button

Press to set up A-B Repeat. *Details are on page 59.*

VOLUME Buttons

Press to adjust the volume. Press "+" to increase the volume. Press "-" to decrease the volume.

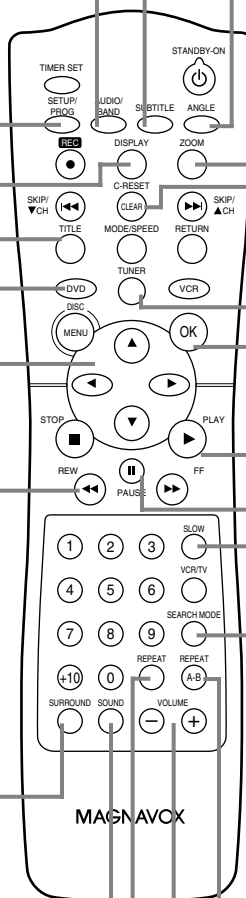

Remote Control (cont'd) 23

TIMER SET Button

Press to set a timer recording.
Details are on pages 38-40.

REC (record) Button

Press to start a VCR recording.
Details are on page 34.

SKIP ◀◀/CH ▼ and SKIP ▶▶/CH ▲ Buttons

In DVD mode, press to skip Chapters or Tracks. In VCR mode, press to change TV channels at the System. In Tuner mode, press and hold to search radio stations. Or, press to increase or decrease the frequency by one-tenth.

MODE/SPEED Button

Press to set a Program. Details are on page 63. Press to start Random play. Details are on page 63. Press to select the VCR's recording speed (SP or SLP). Details are on pages 34 and 77.

DISC/MENU Button

Press to access or remove a DVD Disc menu or the VCR menu.

STOP ■ Button

Press to stop Disc playback, tape playback, or recording. In Tuner mode, press to stop presetting radio stations.

Number Buttons

In DVD mode, press to select a Track or Chapter for playback. Use the +10 button for items 10 and above. Details are on page 57. In VCR mode, use to select TV channels. Enter channel numbers as a two-digit number for the quickest results (to select channel 6, press 0,6). For channels 100 and above, enter a three-digit number (for channel 117, press 1, 1, 7). If you have Cable TV, channels 1-125 are possible. If you have an antenna, channels 2-69 are possible. The +10 button has no effect in VCR mode. In Tuner mode, press the Number buttons to choose a preset radio station.

STANDBY-ON Button

Press to turn the power on or off.

RETURN Button

Press to return to the previous level of the DVD Player's Setup menu or to remove the Setup menu.

VCR Button

Press before using the remote control for VCR features. Press to put the System in VCR mode.

FF ▶▶ (fast forward) Button

In DVD mode, press to fast forward the Disc. Details are on page 55. Press when DVD playback is paused to start slow motion playback. Details are on page 62.

In VCR mode, press to fast forward the tape. Details are on page 45.

VCR/TV Button

With the System in VCR or DVD mode, press to select VCR or TV position.

Select VCR position in VCR mode to watch a tape or to watch/record TV programs (changing channels at the System).

Select VCR position in DVD mode to watch a DVD.

Use TV position to watch TV channels (changing channels at the TV) or watch one program while recording another. Details are on page 35.

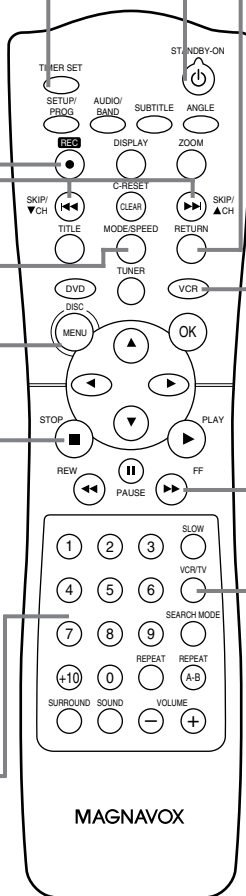

Helpful Hints

- For DVD Player features, press DVD before pressing other buttons. To put the System in DVD mode, press DVD or SOURCE so the red DVD light appears on the front of the System.
- For VCR features, press VCR before pressing any other buttons. To put the System in VCR mode, press VCR or SOURCE so the red VCR light appears on the front of the System.
- For Tuner features, press TUNER before pressing any other buttons. To put the System in Tuner mode, press TUNER or SOURCE so the red TUNER light appears on the front of the System.

24 Front Panel

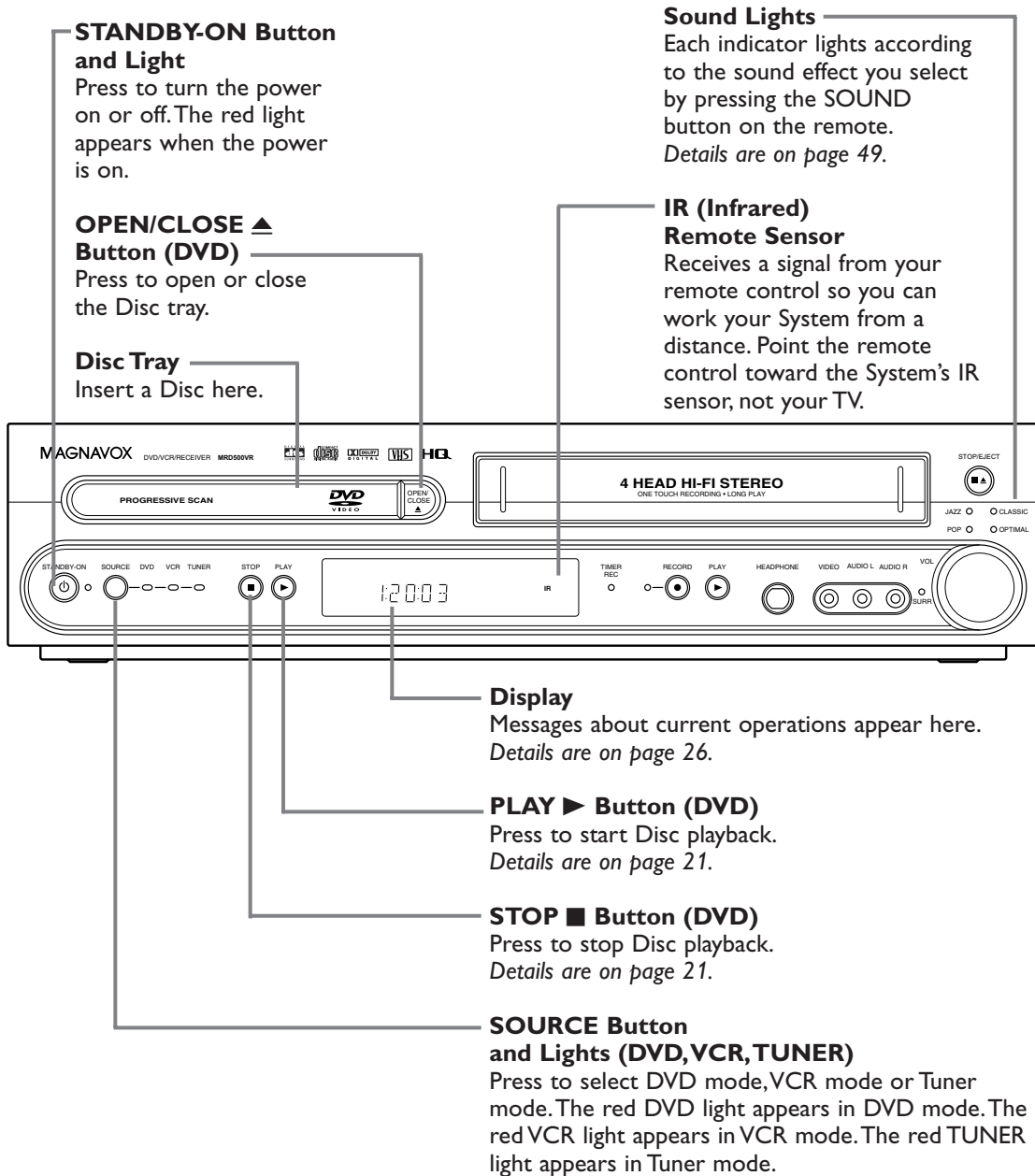

Front Panel (cont'd) 25

VOLUME Dial

Turn clockwise to increase the volume; turn counter-clockwise to decrease the volume. The volume level will appear briefly on the display panel.

STOP/EJECT ■▲ Button (VCR)

Press once to stop tape playback. When play is stopped, press to eject the tape.

Cassette Compartment

Insert a videotape here.

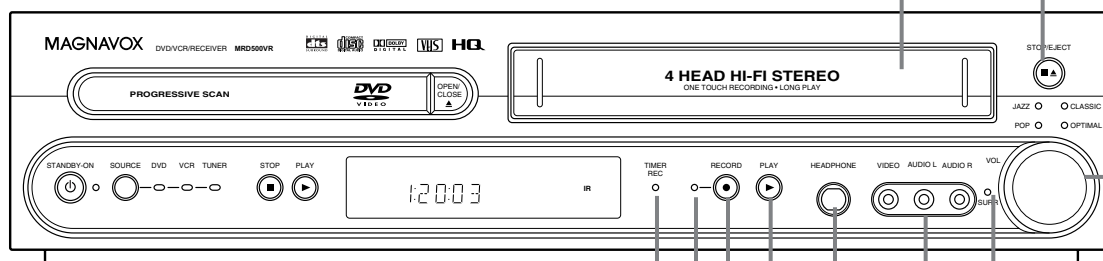

TIMER REC Light

This red light glows when the System is set for a timer recording or during a One-Touch Recording. It flashes if a timer recording is set but no tape is in the System. It flashes when all timer recordings or One-Touch Recordings are finished.

RECORD Light

This red light appears during VCR recording. It flashes when recording is paused.

RECORD ● Button (VCR)

Press once to start a recording. Press repeatedly to start a One-Touch Recording. *Details are on page 36.*

PLAY ► Button (VCR)

Press to play a video cassette. Press to release Slow, Search, or Still mode and return to playback. *Details are on page 45.*

HEADPHONE Jack

Connect headphones (not supplied) here. When headphones are connected, Surround Sound is not available.

AUDIO and VIDEO In Jacks

Connect audio and video cables coming from the audio and video out jacks of a camcorder, another VCR, another DVD Player, or audio system here. This will be useful if you want to copy a videotape or watch material that is playing on other equipment. *Details are on page 37.*

SURR (Surround) Light

This light appears when Surround Sound is On. *Details are on page 49.*

26 Display Panel

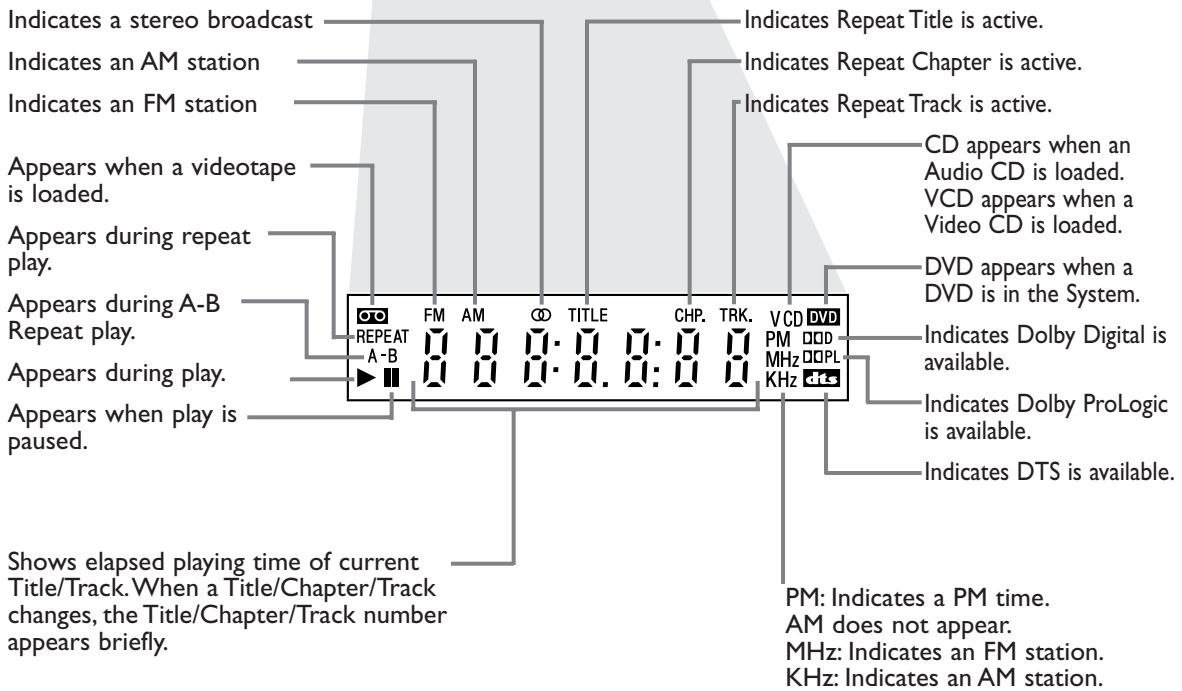
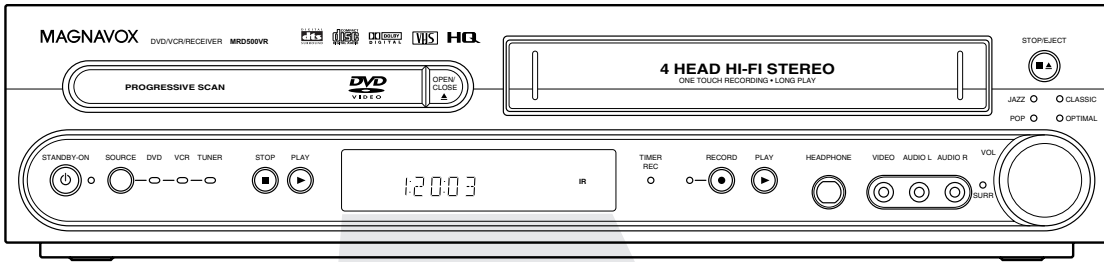

Display Messages

DVD

- - - -	Appears after the Disc tray closes if the tray is empty, if there is an error reading the Disc, or if an unacceptable Disc is installed.	CLOSE	Tray is closing.
OPEN	Tray is opening or is open.	Load	Disc is loading.

VCR

SP	Appears for five seconds to indicate SP as recording speed.	SLP	Appears for five seconds to indicate SLP as recording speed.
----	---	-----	--

Rear Panel 27

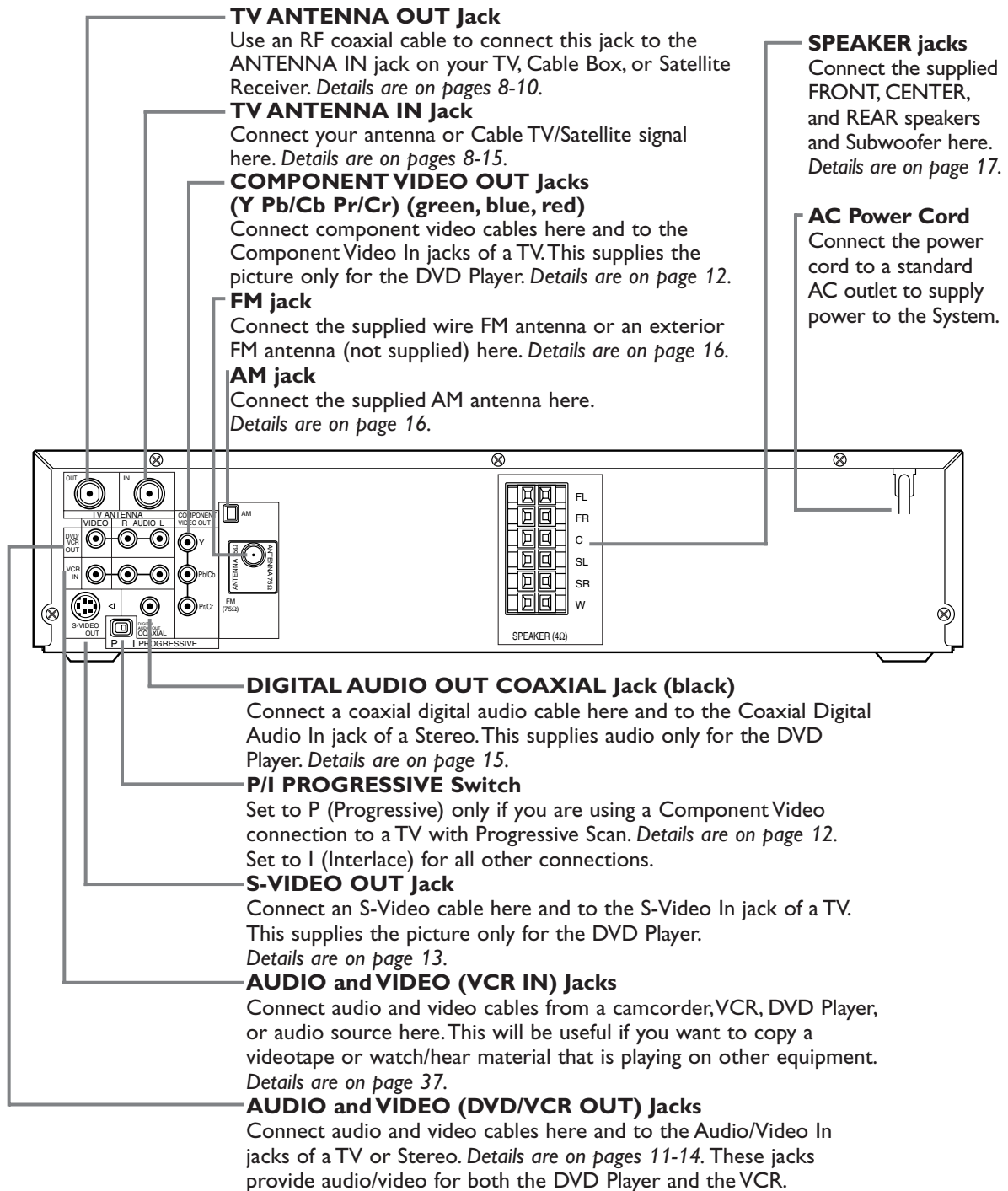

Helpful Hint

- The S-VIDEO OUT, COMPONENT VIDEO OUT, and DIGITAL AUDIO OUT COAXIAL jacks are only useful in DVD mode. To have sound and picture in VCR mode, connect either the RF coaxial cable or the audio/video cables. *Details are on pages eight and 11.*

28 Channel Setup

Although your System may automatically memorize the channels you receive when you turn it on for the first time, you can set up the channels again.

- 1 Press **VCR**, then press **DISC/MENU** so the main menu appears.

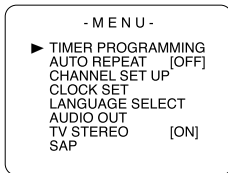

- 2 Press **▲** or **▼** to select **CHANNEL SET UP**. Then, press **▶**.

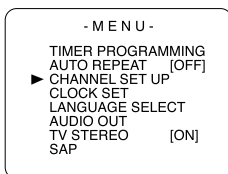

- 3 Press **▲** or **▼** to select **AUTO SET UP**. Press **▶**.

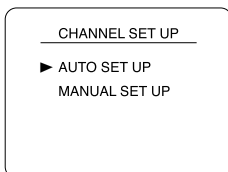

- 4 **AUTO SET UP** will flash while the System sets up the available channels. When setup is complete, the lowest available channel will appear on the TV.

Now when you press **SKIP ▶▶▶ /CH ▲** or **SKIP ◀◀◀ /CH ▼**, you will scan only through available channels. You still can select any channel using the Number buttons.

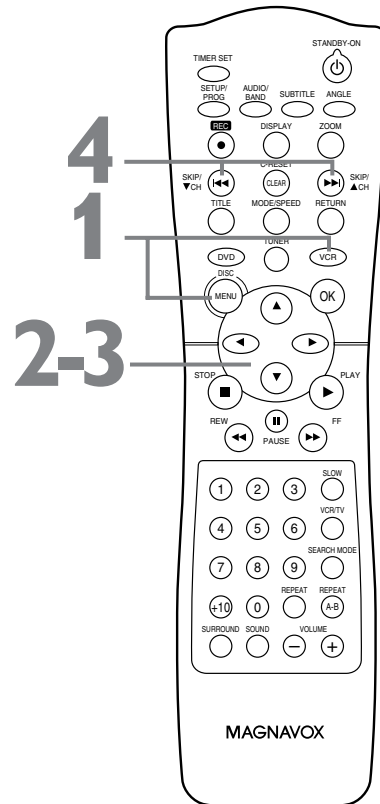
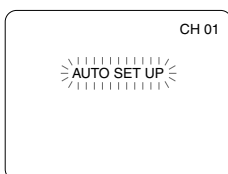

Helpful Hints

- You cannot program channels if you are using a Cable Box or Satellite Receiver.
- If you have an antenna, channels 2-69 will be possible. If you have Cable TV, channels 1-125 will be possible.
- To stop Channel Setup, press **DISC/MENU** while **AUTO SET UP** is flashing.

Channel Setup (cont'd) 29

Adding/Deleting Channels

You may want to add or delete TV channels if your channel lineup changes or if you no longer watch some channels.

1 Press **VCR**, then press **DISC/MENU** so the main menu appears.

2 Press **▲** or **▼** to select **CHANNEL SET UP**, then press **▶**.

3 Press **▲** or **▼** to select **MANUAL SET UP**, then press **▶**.

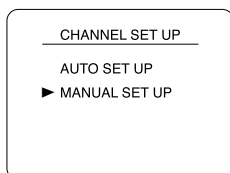

4 Press **▲** or **▼** until the channel number you want to add or delete appears on the screen.

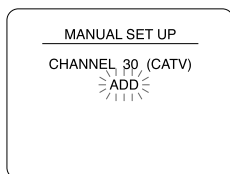

5 Press **▶** or **◀** so **ADD** or **DELETE** flashes on the screen.

6 While your choice is flashing, press **C-RESET/CLEAR**. The channel you added or deleted will be the current channel. Added channels are available when you flip through channels using the **SKIP ▶▶/CH ▲** and **SKIP ◀◀/CH ▼** buttons. You still can select deleted channels with the Number buttons.

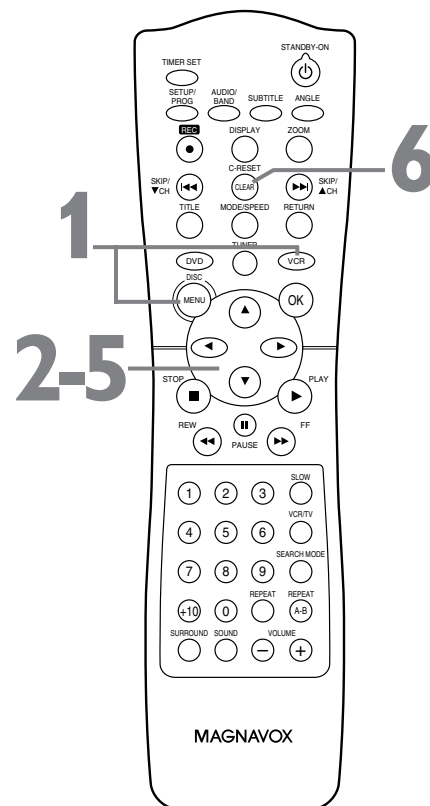

30 Clock (VCR)

Follow these steps to set the VCR clock. Make sure:

- The System is on and in VCR mode. Press VCR so the red VCR light appears on the front of the System.

- 1 Press DISC/MENU.** If the clock has never been set, the CLOCK SET menu will appear. Go to step 3.
- 2 Press ▲ or ▼ to select CLOCK SET, then press ►.**
- 3 While the MONTH space is flashing, press ▲ or ▼ until the month appears. Then, press ►.**

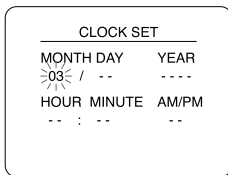

- 4 While the DAY space is flashing, press ▲ or ▼ until the day appears. Then, press ►.**

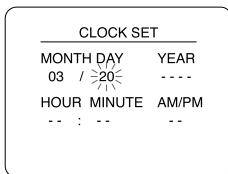

- 5 While the YEAR space is flashing, press ▲ or ▼ until the year appears. Press ►.** The day of the week will appear automatically.

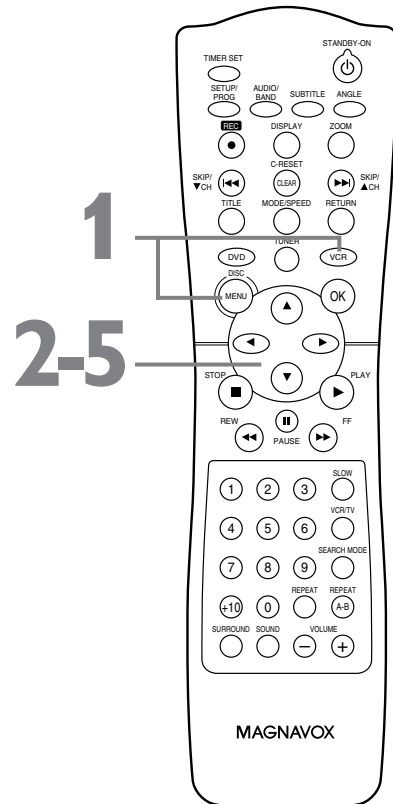
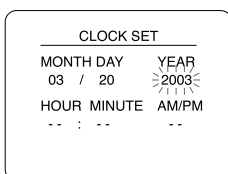

Helpful Hints

- To check the time, press DISPLAY until the time appears on the TV screen.
- Power failures of more than 30 seconds can erase the clock setting.

Clock (VCR) (cont'd) 31

- 6** While the **HOUR** space is flashing, press **▲** or **▼** until the hour appears. Then, press **▶**.

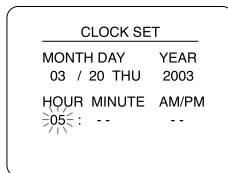

- 7** While the **MINUTE** space is flashing, press **▲** or **▼** until the minute appears. Then, press **▶**.

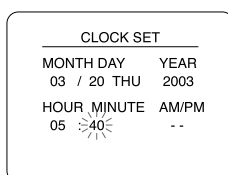

- 8** While the **AM** or **PM** space is flashing, press **▲** or **▼** to select **AM** or **PM**.

Your selection will flash on the screen in the AM/PM space.

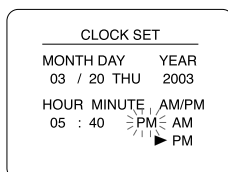

- 9** Press **C-RESET/CLEAR** or **▶** to start the clock.

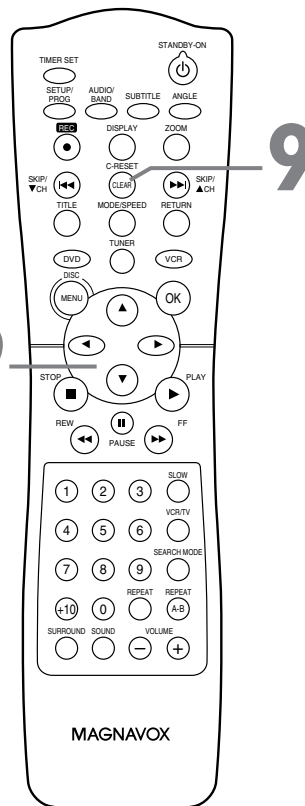

Helpful Hints

- To reset the clock, follow steps 1-2 on page 30. Select the information you want to change using **▶** or **◀**. When the information is flashing, use **▲** or **▼** to enter the correct information. Press **C-RESET/CLEAR** to set the clock.

32 Language (VCR)

Follow the steps below to change the language of the VCR on-screen displays and menus.

1 Press VCR, then press DISC/MENU.

```

- M E N U -
▶ TIMER PROGRAMMING
  AUTO REPEAT [OFF]
  CHANNEL SET UP
  CLOCK SET
  LANGUAGE SELECT
  AUDIO OUT
  TV STEREO [ON]
  SAP
  
```

2 Press ▲ or ▼ to choose LANGUAGE SELECT, then press ▶.

```

- M E N U -
  TIMER PROGRAMMING
  AUTO REPEAT [OFF]
  CHANNEL SET UP
  CLOCK SET
  ▶ LANGUAGE SELECT
  AUDIO OUT
  TV STEREO [ON]
  SAP
  
```

3 Press ▲ or ▼ to choose ENGLISH, FRANCAIS (French), or ESPAÑOL (Spanish).

```

LANGUAGE SELECT
▶ ENGLISH [ON]
  FRANCAIS
  ESPAÑOL
  
```

4 Press C-RESET/CLEAR to remove the menu.

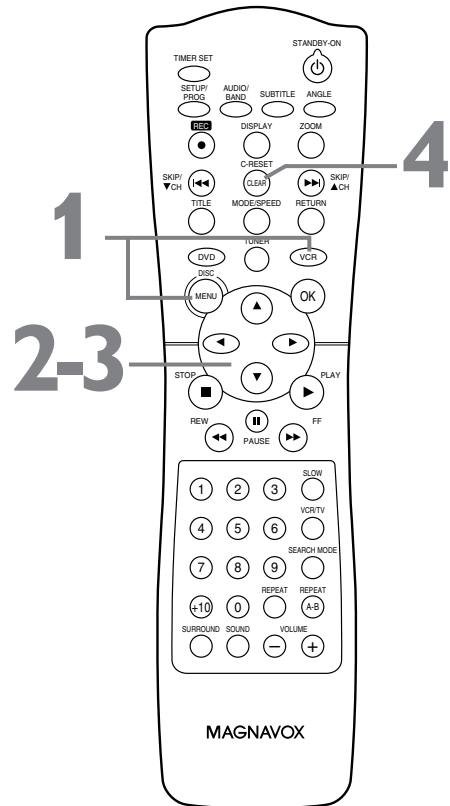

Helpful Hint

- If you select French or Spanish and need English:
 - 1) Press DISC/MENU so the main MENU appears.
 - 2) Press ▼ to choose SELECTION LANGUE or SELEC. IDIOMA, then press ▶.
 - 3) Press ▲ or ▼ to select ENGLISH.
 - 4) Press C-RESET/CLEAR.

VCR Status Displays 33

You may access status displays by pressing DISPLAY on the remote. The displays may include the current time, channel, and other information.

- 1 **Press DISPLAY.** The COUNT display will appear for five seconds. After five seconds, only the real-time tape counter will appear. This counter shows you the elapsed playing time of the tape (from the point at which the counter was set to zero). The counter display will also appear on the System's display panel.

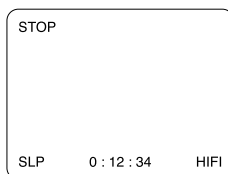

- 2 **Press DISPLAY again.** The CLOCK display will appear for five seconds. After five seconds, only the time will appear (the clock must be set). (If you are watching TV, the channel number and the availability of stereo or second audio will also appear.) The current time will also appear on the display panel.

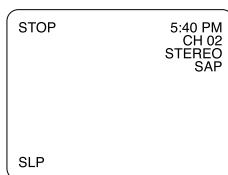

- 3 **Press DISPLAY again to remove all the displays.**

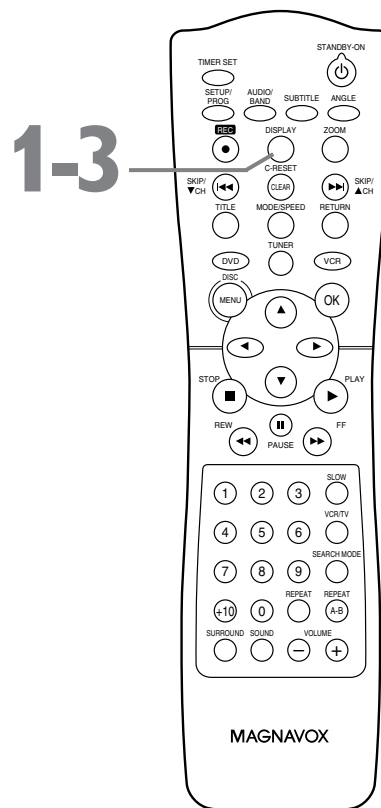

Helpful Hints

- If the channel you select has no broadcast, the screen will be solid blue.
- You cannot access a status display when viewing a still picture, during slow motion, or during forward and reverse searching.
- Channel numbers appear on the TV screen for a few seconds each time you change channels.

34 Videotape Recording

Read and follow the steps below to record a television program onto a videotape. **Before you begin, make sure the System is in VCR mode. Press VCR so the red VCR light appears on the front of the System.**

- 1 Turn on the TV and set it to channel 3 or 4 or the Video In channel.** If you connected the System to the TV using the supplied audio and video cables, select your TV's Video In channel. *Details are on page 11.*
If you connected the System to the TV using the supplied RF coaxial cable, choose channel 3 (or 4) at the TV. *Details are on pages 8-10.*
- 2 Insert a tape with its record tab intact into the cassette compartment of the System.** If tape playback begins, press STOP ■.
- 3 Press MODE/SPEED until the desired tape speed (SP or SLP) appears briefly on the TV screen and the System's display panel.**
Details about tape speed are on page 77.
- 4 Press SKIP ►► /CH ▲ or SKIP ◄◄ /CH ▼ or the Number buttons to select the TV channel to record.**
- 5 Press REC ● to start recording.** The red RECORD light will appear on the front of the System.
- 6 To pause the recording, press PAUSE || once.** The red RECORD light will flash. **To resume recording, press REC ● or press PAUSE || again.** The red RECORD light will come on again.
- 7 To stop recording, press STOP ■.**

- 1** Turn on the TV.
- 2** Insert a tape in the System.

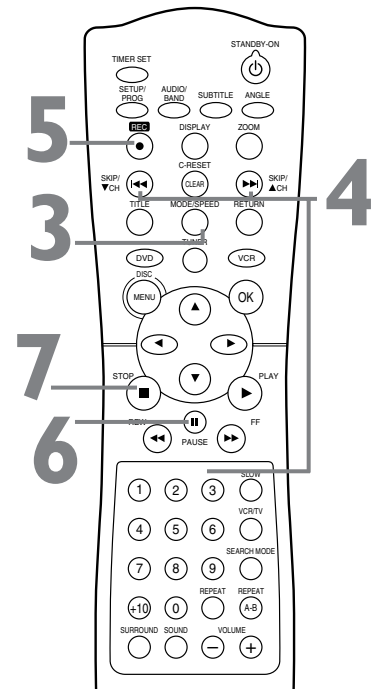

Recording Prevention

Video Cassettes have record tabs to ensure that recordings are not accidentally erased.

- 1 To prevent recording, break off the tab with a screwdriver.**
- 2 To allow recording, cover the hole with clear tape.**

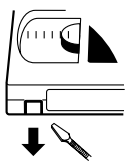

Remove the tab to prevent recording.

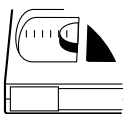

Cover the hole to allow recording.

Helpful Hints

- Other recording options are on pages 35-41.
- The VCR will record in a preset volume.
- Pause will switch to Stop after five minutes to protect the VCR and the tape from damage. When a recording is paused, review the pause time remaining with the | marks on the TV screen. Each | mark equals one minute remaining. During the last minute of paused recording, the | mark will flash.
- If any menu is on the TV screen, the REC ● button on the remote does not function. Press C-RESET/CLEAR to remove the menu. Then, press REC ●. Or, use the RECORD ● button on the front of the System.

Recording One Channel/Watching Another 35

- 1** Press **VCR**, then press **REC** ● to record the current TV channel. *Details are on page 34.*
- 2** Press **VCR/TV** once to put the System in TV position.
- 3** Use the TV remote control to select the channel you want to watch at the TV.
- 4** To return to the channel being recorded, use the TV remote control to select channel **03** or **04** at the TV. *Details are on page eight.* Or, if you connected the System to the TV using audio and video cables, select the TV's correct Video In channel. *Details are on page 11.*
- 5** Press **VCR/TV** on the System's remote control to put the System back in **VCR** position. The channel being recorded will appear on the TV screen.
- 6** Press **STOP** ■ to stop the recording.

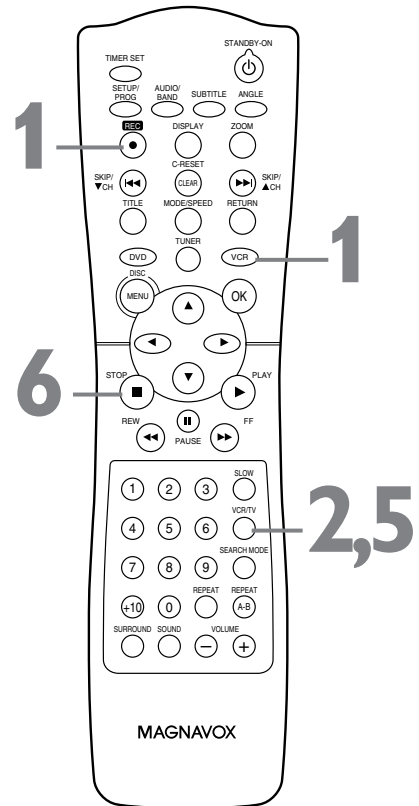

3 Select the channel you want to watch at the TV.

4 Select channel 03, 04, or Video In at the TV.

Helpful Hints

- If you use a Cable Box or Satellite Receiver, you may not be able to watch one channel while recording another. See pages 9-10 for details.

36 One-Touch Recording

One-Touch Recording (OTR) lets you set a timed recording 30 minutes to eight hours long. Before you begin:

- Place the System in VCR mode. Press VCR so the red VCR light appears on the front of the System.
- Select a recording speed (SP, SLP) with the MODE/SPEED button.
- Put a videotape in the cassette compartment. Make sure the tape's record tab is intact and the tape is long enough to record the program(s).

- 1 Press SKIP ►► /CH ▲ or SKIP ◄◄ /CH ▼ or the Number buttons to select the channel you want to record.**
- 2 Press RECORD ● on the front of the System until the desired recording length (30 minutes to eight hours) appears on the TV screen.** Recording will begin. The RECORD light and the TIMER REC light will appear on the front of the System.

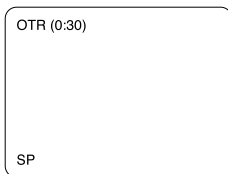

Stopping an OTR

To stop an OTR before recording is finished, press STOP ■ on the remote control or STOP/EJECT ■▲ on the front of the System.

To cancel the OTR but continue recording, press RECORD ● on the front of the System repeatedly until REC appears in the upper left corner of the TV screen.

When an OTR finishes, the System will switch to DVD mode and/or turn itself off. The TIMER REC light will flash because the VCR of the System is still on standby for timer recordings. Press TIMER SET on the remote or STOP/EJECT ■▲ on the System to cancel timer standby and use the VCR of the System normally again.

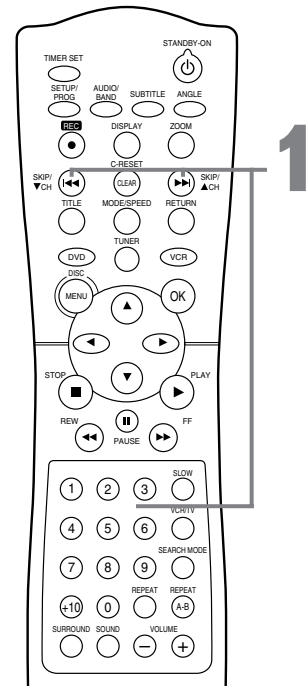

- 2 Press RECORD ● on the front of the System.**

Helpful Hints

- The remaining recording time will appear on the display panel. Press DISPLAY to see it on the TV screen.
- To change the recording length while an OTR is in progress, press RECORD ● on the front of the System.
- You cannot start a timed OTR with the REC ● button on the remote.
- You cannot pause an OTR.
- If the end of the tape is reached during an OTR, the VCR will stop recording, eject the tape, and switch to DVD mode and/or turn off. The TIMER REC light will flash. Press TIMER SET on the remote or STOP/EJECT ■▲ on the System to cancel timer standby and use the VCR again.
- If you press TIMER SET for a Timer Recording, the OTR will stop immediately. The System will switch to DVD mode or turn off for the recording.

Rerecording (Tape Duplication) 37

These instructions show you how to copy videotapes. The illustration uses two MRD500 Systems. Other VCRs or Camcorders may operate differently.

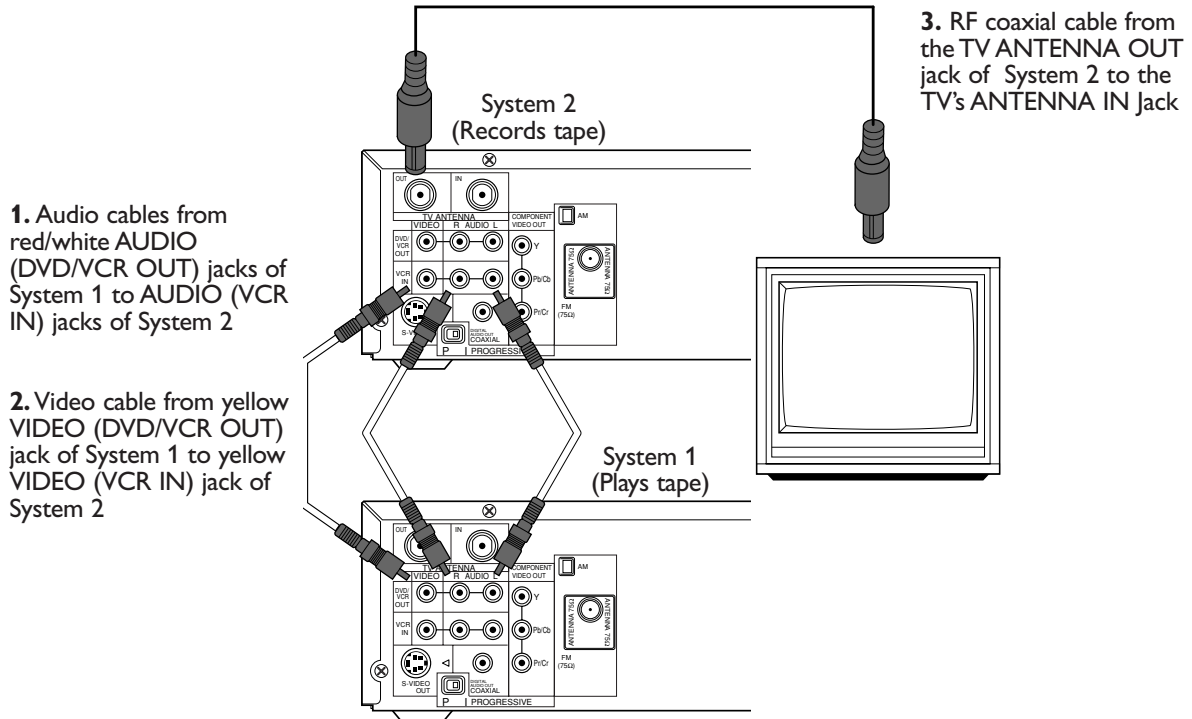

- 1** Make the connections shown above.
- 2** System 1 will play your tape. **Put a prerecorded tape into the cassette compartment of System 1.** Press VCR to put the unit in VCR mode if necessary.
- 3** System 2 will record your tape. **Insert a blank tape in the cassette compartment of System 2.** Press VCR to put the unit in VCR mode if necessary.
- 4** Turn on the TV and set it to channel 03 (the RF output channel of System 2). (To change the System's output channel, see step 6 on page eight.)
- 5** Point the remote control at System 2. Press Number buttons 0, 0, 1 or 0, 0, 2. (See Helpful Hints at right.)
- 6** Press **MODE/SPEED** to select **SP** or **SLP** at System 2.
- 7** Press **PLAY ► (VCR)** on the front of System 1 and **RECORD ●** on the front of System 2 at the same time.

To stop recording, press **STOP/EJECT ■▲** on System 1, then press **STOP/EJECT ■▲** on System 2.

Helpful Hints

- If you use the **AUDIO** and **VIDEO (VCR IN)** jacks on the back of System 2, press Number buttons 0, 0, 1 at step 5. L1 will appear on the TV screen and the System's display panel.
- If you use the **AUDIO** and **VIDEO In** jacks on the front of System 2, press Number buttons 0, 0, 2 at step 5. L2 will appear on the TV screen and the System's display panel.
- Unauthorized recording of copyrighted television programs, videotapes, or other materials may infringe on the rights of copyright owners and violate copyright laws.
- If a program has copyright protection, it may not record clearly.

38 Timer Recording

Follow these steps to program the System's VCR to record TV programs while you're away. Before you begin:

- Set up the TV channels at the System. *Details are on page 28.*
- Set the clock. *Details are on pages 30-31.*
- Put a tape in the cassette compartment. Make sure the tape's record tab is intact and the tape is long enough to record the program(s). If the end of the tape is reached during a Timer Recording, recording will stop. The tape will eject and the System will turn off.
- Press VCR so the red VCR light appears on the front of the System.

1 Press **DISC/MENU** so the **MENU** appears.

2 Press **▲** or **▼** to select **TIMER PROGRAMMING**. Then, press **▶**. Program numbers that do not have a timer recording stored will flash.

```
TIMER PROGRAMMING
PROG.      12345678
DATE
START TIME
END TIME
CHANNEL
REC SPEED
```

3 Press **▲** or **▼** to select an empty program. Then, press **▶**.

```
PROGRAM NUMBER 1
DATE           -/-
START TIME     -:-:-
END TIME       -:-:-
CHANNEL        -
REC SPEED      -
```

4 Press **▲** or **▼** to select **ONCE**, **DAILY**, or **WEEKLY**. Then, press **▶**.

- **ONCE** - The VCR will record a TV program on any day you choose, up to 12 months away.
- **DAILY** - The VCR will record a TV program at the same time on the same channel every day, Monday through Friday.
- **WEEKLY** - The VCR will record a TV program at the same time on the same channel every week, for example, every Monday.

```
PROGRAM NUMBER 1
▶ ONCE
  DAILY
  WEEKLY
```

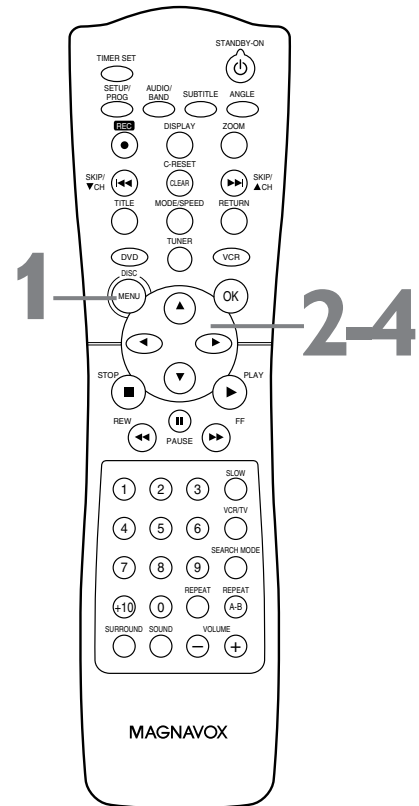

Helpful Hints

- You cannot access the **TIMER PROGRAMMING** menu at step 2 if the clock is not set. The **CLOCK SET** menu will appear. Follow the steps on pages 30-31 to set the clock.
- Only programs that will air Monday-Friday can be recorded on a **DAILY** basis. If you select **DAILY** at step 4, then enter a Saturday or Sunday **DATE** at step 5, the correct program will not be recorded. The VCR will alter the recording date (changing it to a Monday-Friday date) and record a different program than the one you intended.

Timer Recording (cont'd) 39

- 5** Press **▲** or **▼** until the month appears beside **DATE**. Then, press **▶**. Next, press **▲** or **▼** until the day appears. Then, press **▶**. The day of the week will appear. You cannot record more than one year in advance.

```

ONE TIME PROGRAM
PROGRAM NUMBER 1
DATE 05/04 TUE
START TIME --:--:--
END TIME --:--:--
CHANNEL --
REC SPEED --
  
```

- 6** To enter the recording's start time, press **▲** or **▼** until the hour appears beside **START TIME**. Press **▶**. Press **▲** or **▼** until the minute appears. Press **▶**. Finally, press **▲** or **▼** to point to **AM** or **PM**. AM or PM will flash beside the start time. Press **▶**.

```

ONE TIME PROGRAM
PROGRAM NUMBER 1
DATE 05/04 TUE
START TIME 07:30 PM
END TIME --:--:--
CHANNEL --
REC SPEED --
                AM
                PM
  
```

- 7** Repeat the procedure in step 6 to set the recording's end time.

- 8** Press **▲** or **▼** until the channel number appears beside **CHANNEL**. Then, press **▶**.

- If you are using a standard antenna/Cable TV hookup (as shown on page eight), select the channel of the TV program you want to record.
- If you are recording from other equipment, select L1 or L2. To determine L1 or L2, refer to the Helpful Hint below.
- If you are using a Cable Box/Satellite Receiver, select the Cable Box/Satellite Receiver output channel (03 or 04). Then, at the Cable Box/Satellite Receiver, select the channel you want to record. Leave the Cable Box/Satellite Receiver on for the timer recording. Details are on page nine.

```

ONE TIME PROGRAM
PROGRAM NUMBER 1
DATE 05/04 TUE
START TIME 07:30 PM
END TIME 08:30 PM
CHANNEL 16
REC SPEED --
  
```

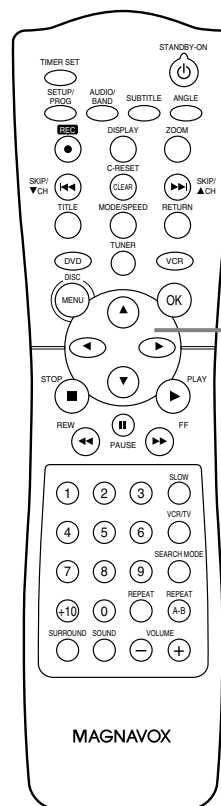

5-8

Helpful Hints

- Enter the information while the space is flashing.
- To stop a started timer recording, press **STOP/EJECT** **■▲** on the front of the System.
- If you are recording from other equipment, set **CHANNEL** to L1 or L2. If you connected the other equipment to the **AUDIO** and **VIDEO** In jacks on the front of the System, choose L2. If you connected the audio and video cables to the **AUDIO IN** and **VIDEO IN** jacks on the back of the System, choose L1. **More Helpful Hints are on page 80.**

40 Timer Recording (cont'd)

- 9** Press **▲** or **▼** to select a recording tape speed. The arrow will appear beside your choice. The selected speed will flash beside REC SPEED. *Tape speed details are on page 77.*

```

ONE TIME PROGRAM
PROGRAM NUMBER 1
DATE           05 / 04 TUE
START TIME    07 : 30 PM
END TIME      08 : 30 PM
CHANNEL       16
REC SPEED     SP
              ▲ SP
              SLP
  
```

- 10** Press **C-RESET/CLEAR** to store the timer recording.

- 11** Press **TIMER SET**. The System will turn off and the red **TIMER REC** light will appear on the front of the System. Or, the System may switch to DVD mode instead. You may use the DVD Player during a timer recording. You may need to press **VCR/TV** on the remote to choose TV position so you can see the DVD picture at the TV.
If you want to use the VCR until time for the recording, don't press **TIMER SET** until a few minutes before the recording should start. Or, press **TIMER SET** only when you know you won't be using the VCR anymore (until after the recording).
When the **TIMER REC** light is on or blinking, you cannot put the System in VCR mode by pressing **VCR** or **SOURCE**. You must first press **TIMER SET** to cancel the timer recording temporarily. Then, you can use the VCR features again.

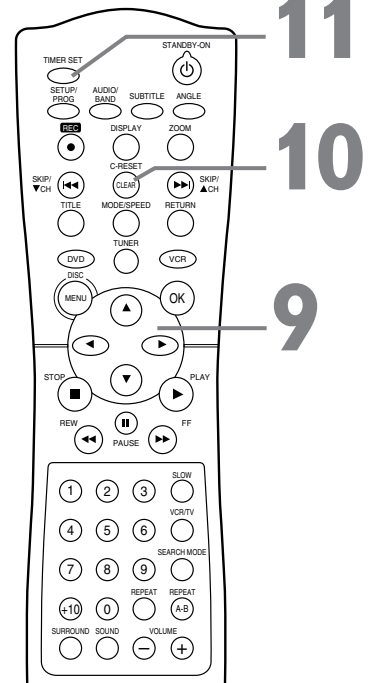

Cancelling Timer Recordings

- 1** Press **VCR**, then press **DISC/MENU**.
- 2** Press **▲** or **▼** to select **TIMER PROGRAMMING**, then press **▶**.
- 3** Press **▲** or **▼** to find the program you want to cancel.
- 4** While the program number is flashing, press **◀** to clear all the information for that program.

```

ONE TIME PROGRAM
PROGRAM NUMBER 1
DATE           05 / 04 TUE
START TIME    07 : 30 PM
END TIME      08 : 30 PM
CHANNEL       16
REC SPEED     SP
  
```

- 5** Press **C-RESET/CLEAR** to remove the menu.

Helpful Hints

- To change incorrect information, press **◀** or **▶** to choose the item you want to change. Press **▲** or **▼** to adjust the information.
- If a timer recording is set and the **TIMER REC** light is on, pressing **STOP/EJECT** **■▲** will turn on the System and/or cancel the timer recording. The **TIMER REC** light will turn off. Press **STOP/EJECT** **■▲** again to remove the tape. To use the VCR or watch TV through the System again, press **VCR**, then **VCR/TV** to put the VCR in VCR position again.
- If there is no tape in the VCR when you press **TIMER SET**, the **TIMER REC** light will flash. Insert a tape.

DVD to Videotape Duplication 41

Follow the steps below to copy a DVD to a videotape.

This will be possible only if the DVD is not copy protected.

Before you begin:

- Put a videotape in the cassette compartment. Make sure the tape's record tab is intact and the tape is long enough to record the DVD.
- Put the DVD you want to copy in the disc tray.
- **Press VCR so the red VCR light appears on the front of the System.**
- Turn on the TV.

- 1** Point the remote control at the System. **Press Number buttons 0, 0, 3.** "DISC" will appear on the TV screen in the top right corner briefly. The DVD logo will also appear.

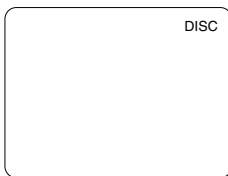

- 2** Press **MODE/SPEED** until the desired tape speed (**SP** or **SLP**) appears briefly in the lower left corner of the TV screen. *Details about tape speed are on page 77.*
- 3** Press **REC ●** to start recording. The red RECORD light will appear on the front of the System.
- 4** Press **DVD**. Press **PLAY ►** to play the DVD.
- 5** To pause the recording, press **VCR**, then press **PAUSE ■■** once. The red RECORD light will flash. To resume recording, press **REC ●** or press **PAUSE ■■** again. The red RECORD light will come on again.
- 6** To stop recording, press **VCR**, then press **STOP ■**.

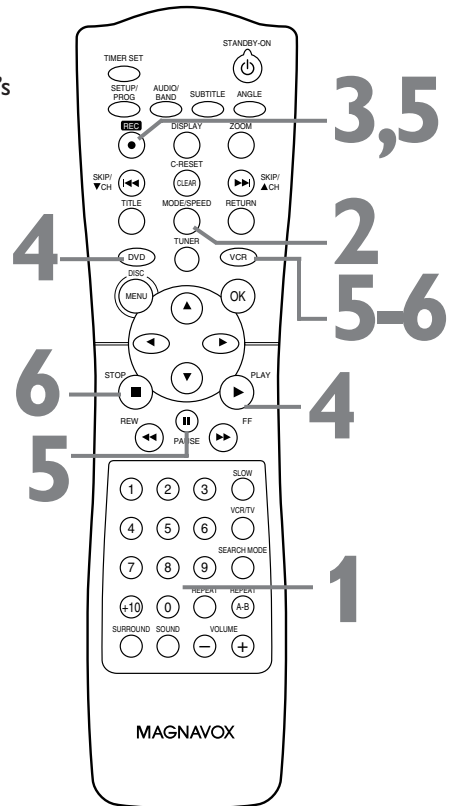

Helpful Hints

- A Timer Recording is not possible during DVD to Videotape duplication.
- You cannot select Tuner mode during DVD to videotape duplication.
- The recording will not be clear if the DVD has copyright protection.

42 Repeat Play

Follow the steps below to play a videotape repeatedly.

1 Press VCR, then press DISC/MENU.

```

- M E N U -
▶ TIMER PROGRAMMING
  AUTO REPEAT [OFF]
  CHANNEL SET UP
  CLOCK SET
  LANGUAGE SELECT
  AUDIO OUT
  TV STEREO [ON]
  SAP
  
```

2 Press ▲ or ▼ to select AUTO REPEAT.

```

- M E N U -
  TIMER PROGRAMMING
▶ AUTO REPEAT [OFF]
  CHANNEL SET UP
  CLOCK SET
  LANGUAGE SELECT
  AUDIO OUT
  TV STEREO [ON]
  SAP
  
```

3 Press ► so ON appears next to AUTO REPEAT.

Tape play will begin immediately. AUTO REPEAT ► will appear on the TV screen briefly.
(If you are fast forwarding or rewinding the tape, press C-RESET/CLEAR to remove the menu, then press PLAY ► to begin tape playback.)
The tape will play to the end, rewind, then play again. (TV programming will appear on the screen while the tape is rewinding.)

```

- M E N U -
  TIMER PROGRAMMING
▶ AUTO REPEAT [ON]
  CHANNEL SET UP
  CLOCK SET
  LANGUAGE SELECT
  AUDIO OUT
  TV STEREO [ON]
  SAP
  
```

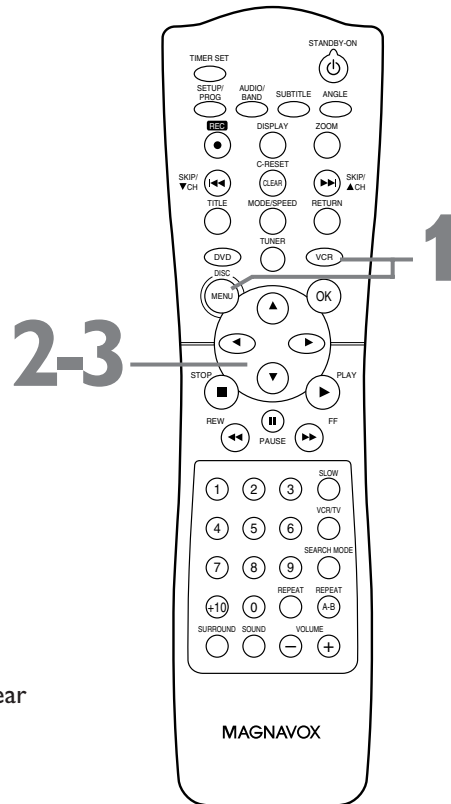

Helpful Hint

- To cancel Auto Repeat, follow steps 1-2. At step 3, press ► so OFF appears beside AUTO REPEAT. Press C-RESET/CLEAR.

Tape Counter 43

Follow the steps below to reset the VCR's real-time tape counter to zero at a tape location you want to refer to later.

1 Press **VCR**, then **play**, **fast forward**, or **rewind** a tape to the location that you would like to refer to later. Press **STOP** ■ to stop the tape.

2 Press **DISPLAY** to see the status display.

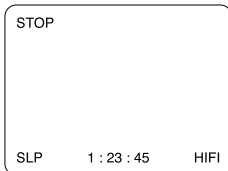

3 While the counter is on the screen, press **C-RESET/CLEAR** to reset the counter to zero.

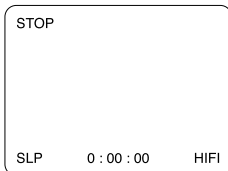

4 When you later want to return to this point on the tape, press **DISPLAY** so you can see the counter (while tape play is stopped). Press **REW** ◀◀ or **FF** ▶▶.

As the tape rewinds or forwards, watch the counter. When it reaches zero, press **PLAY** ▶ to play the tape.

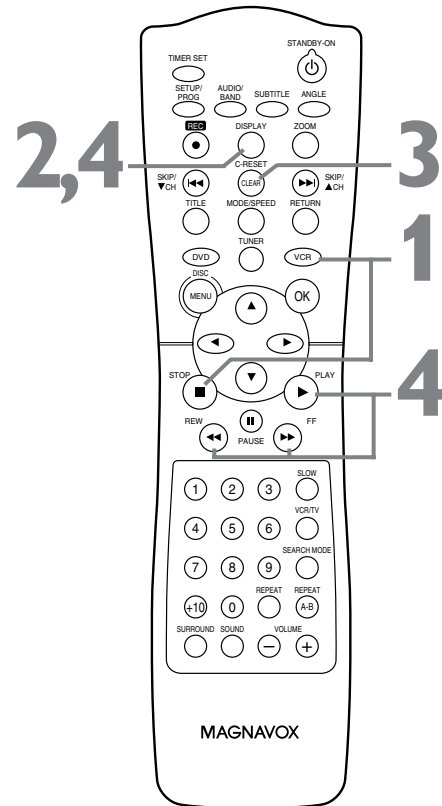

Helpful Hints

- You may only set the counter to zero at one location at a time. Setting the counter to zero at a second location will erase the previous zero setting.
- The counter will reset to zero when you insert a tape.

44 Time Search, Index Search

Time Search

Follow the steps below to search forward or backward on a tape a specific length of time. There must be a tape in the cassette compartment.

- 1 Press **VCR**, then press **SEARCH MODE** until the **TIME SEARCH** screen appears.



- 2 Within 30 seconds, press **▲** or **▼** until your desired length of time appears. Or, press and hold **▲** or **▼** until you reach the desired length of time. You can set a Time Search for up to 9 hours and 59 minutes (9:59).

- 3 Within 30 seconds, press **◀** (for a reverse search) or **▶** (for a forward search). The VCR begins rewinding or fast forwarding the tape. When it finishes, play will begin. The time will count down beneath TIME SEARCH during the search. If the end of the tape is reached during the search, the search will stop and the tape may rewind. *Details are on page 46.*

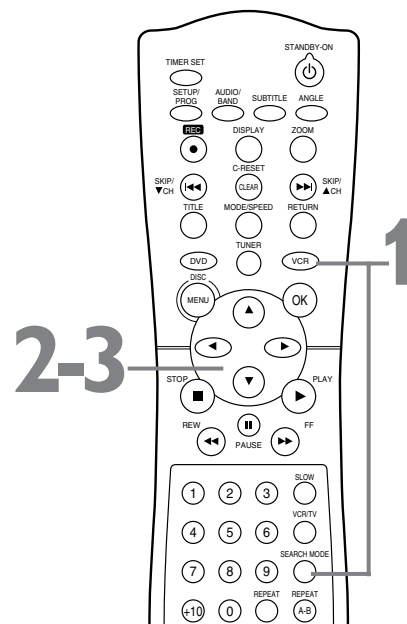

Index Search

An Index Mark is made automatically at the beginning of each recording. Essentially, an Index Mark is a "bookmark." Find the start of a recording by following these steps.

- 1 Press **VCR**, then press **SEARCH MODE** until the **INDEX SEARCH** screen appears.

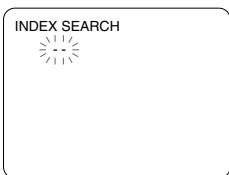

- 2 Within 30 seconds, press **▲** or **▼** until the number of programs you want to skip appears beneath INDEX SEARCH. Include the current program in your number. You may skip up to 20 programs.

- 3 Within 30 seconds, press **◀** (for a reverse search) or **▶** (for a forward search). When the tape finishes rewinding or forwarding, playback will start. The program numbers will count down beneath INDEX SEARCH during the search. If the end of the tape is reached during the search, the search will stop and the tape may rewind. *Details are on page 46.* Recordings should be at least one minute long in SP speed, two minutes in LP, and three minutes in SLP. Otherwise, the Index Mark will not be available. *Details on tape recording speeds are on page 77.*

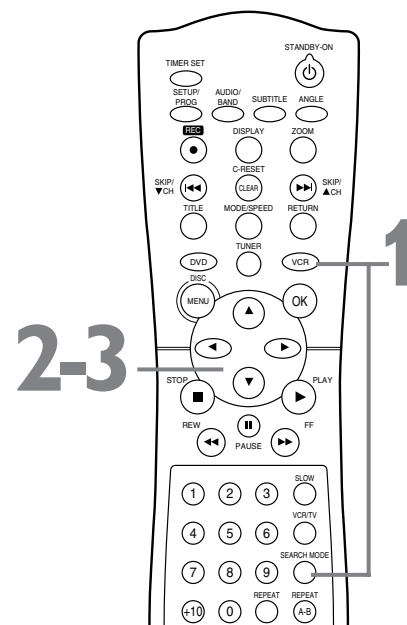

Helpful Hints

- Time Search and Index Search are not available during recording.
- To remove a Search display, press C-RESET/CLEAR.
- To cancel a search, press STOP ■.

Special Effects Playback 45

- Before you begin, press VCR so the red VCR light appears on the front of the System.

Forward and Reverse Searching (SP/LP/SLP)

- 1 During tape playback, press and release **FF** ►► or **REW** ◀◀. A fast forward or reverse picture search will begin.
- 2 To return to playback, press **PLAY** ►.

Super High Speed Searching (LP/SLP)

- 1 During tape playback, press **FF** ►► or **REW** ◀◀, then press again. The search speed will increase. Repeatedly pressing **FF** ►► or **REW** ◀◀ will switch between regular and high speed searching.
- 2 To return to normal playback, press **PLAY** ►.

Viewing a Still Picture

- 1 During tape playback, press **PAUSE** |||. A still picture will appear on the screen.
- 2 To advance the still picture one frame at a time, press **PAUSE** ||| repeatedly.
- 3 To release the still picture and return to playback, press **PLAY** ►.

Viewing a Slow Motion Picture

- 1 During tape playback, press **SLOW**. The tape will play in slow motion.
- 2 To return to normal playback, press **PLAY** ►.

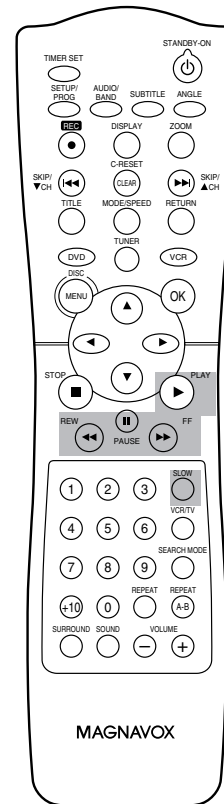

Helpful Hints

- Slow and Still modes will switch to Stop mode after five minutes to protect the System's VCR and the tape from damage.
- SP/LP/SLP means this feature will work with tapes recorded in Standard Play, Long Play, or Super Long Play. LP/SLP means this feature will work with tapes recorded in Long Play or Super Long Play. Tape speed details are on page 77.

46 Automatic Operation Features

The following tape features are available in VCR mode. Press VCR so the red VCR light is on, if necessary.

Automatic Playback

When you put a tape in the System, the power will come on. If the tape's record tab is missing, playback will begin.

If a timer recording is set and the TIMER REC light is flashing, the power will not come on automatically when you insert a tape with the record tab intact.

If a timer recording is set and the TIMER REC light is flashing, the System will eject the tape if the record tab is missing.

Automatic Rewind, Eject

When a tape is played, fast forwarded, or recorded to its end, the tape will rewind to the beginning, stop, and eject.

This feature does not operate if AUTO REPEAT is ON. *Details are on page 42.*

Tape Eject

A tape can be ejected with the System power on or off (but the System's power cord must be plugged in).

If a timer recording is set and the TIMER REC light is on, pressing STOP/EJECT ■▲ will turn on the System and/or cancel the timer recording. The TIMER REC light will turn off. Press STOP/EJECT ■▲ again to remove the tape. Remember to insert a tape and press TIMER SET to reset the timer recording.

Automatic Tracking Adjustment

The VCR adjusts tracking automatically to give you the best possible picture quality. With some recordings, however, you may get a better picture using manual tracking (see below).

Manual Tracking

To adjust the tracking during normal and slow motion playback, press SKIP ►► /CH ▲ or SKIP ◀◀ /CH ▼ on the remote.

Tracking will return to Automatic Tracking when you press STOP ■ or insert a tape.

Furthermore, you can press SKIP ►► /CH ▲ or SKIP ◀◀ /CH ▼ to remove vertical jitter in a Still picture.

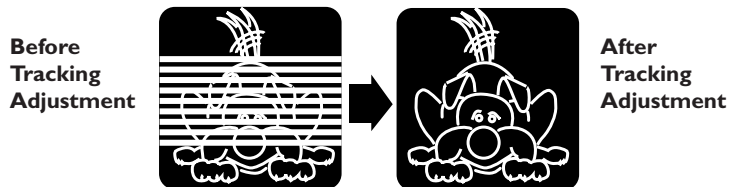

Multi-Channel Television Sound 47

Your System can play tapes recorded in Hi-Fi (high fidelity) stereo, which produces a crisp, clear sound from the left and right audio channels. Your System also can play tapes recorded in a second audio (usually, that means your program is recorded in a second language). Of course, your System will play tapes recorded in monaural (single-source) sound as well.

Your System also will record a video cassette in Hi-Fi stereo or in second audio, so when you play that tape on the System, it will be in stereo or second audio.

Read the directions on this page to familiarize yourself with the stereo and second audio setups. Follow the directions below to record in stereo or second audio. Follow the directions on page 48 to play tapes recorded in Hi-Fi stereo.

Understanding Displays

When you watch TV channels through the System, portions of the display shown below will appear when you press DISPLAY twice.

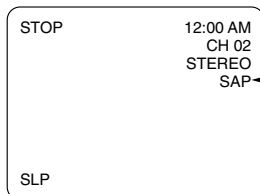

If SAP or STEREO appears, the program is available in second audio or stereo. Even though a program is available in second audio or stereo, you must program the System to receive or record the program. Follow the directions below. This display is not available during tape play.

To set the System to receive programs in stereo or second audio, follow these steps.

1 Press VCR, then press DISC/MENU.

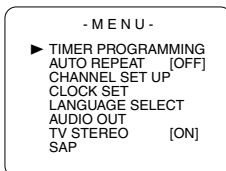

2 Press ▲ or ▼ to select TV STEREO or SAP (Second Audio Program). Press ► so ON appears beside your selection.

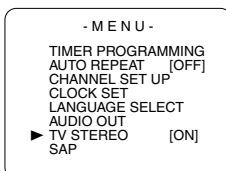

3 Press DISC/MENU to remove the menu.

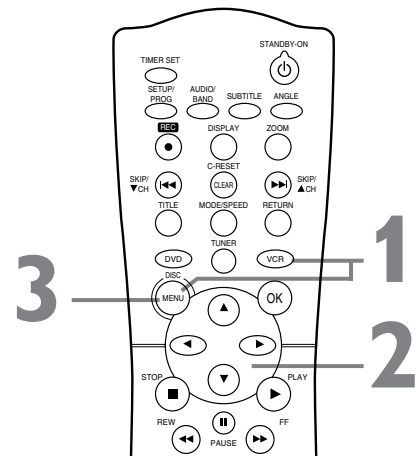

Helpful Hints

- You can only receive and record in stereo or second audio programs that are broadcast in stereo or second audio. You can only play in stereo or second audio tapes that were recorded in stereo or second audio. The display shows you if the program is in stereo or second audio.
- If SAP is ON but the program is not broadcast in Second Audio, you will hear and record the program in normal audio.

48 Hi-Fi Stereo

Multi-Channel Television Sound system broadcasts are recorded in Hi-Fi stereo. To play in Hi-Fi stereo the tapes recorded in Hi-Fi stereo, follow these steps.

1 Press VCR, then press DISC/MENU.

```

- M E N U -
▶ TIMER PROGRAMMING
  AUTO REPEAT [OFF]
  CHANNEL SET UP
  CLOCK SET
  LANGUAGE SELECT
  AUDIO OUT
  TV STEREO [ON]
  SAP
  
```

2 Press ▲ or ▼ to select AUDIO OUT. Then, press ▶.

```

- M E N U -
  TIMER PROGRAMMING
  AUTO REPEAT [OFF]
  CHANNEL SET UP
  CLOCK SET
  LANGUAGE SELECT
  ▶ AUDIO OUT
  TV STEREO [ON]
  SAP
  
```

3 Press ▲ or ▼ to select HIFI. ON will appear beside HIFI.

```

  AUDIO OUT
  ▶ HIFI [ON]
  MONO
  
```

4 Press DISC/MENU to remove the menu.

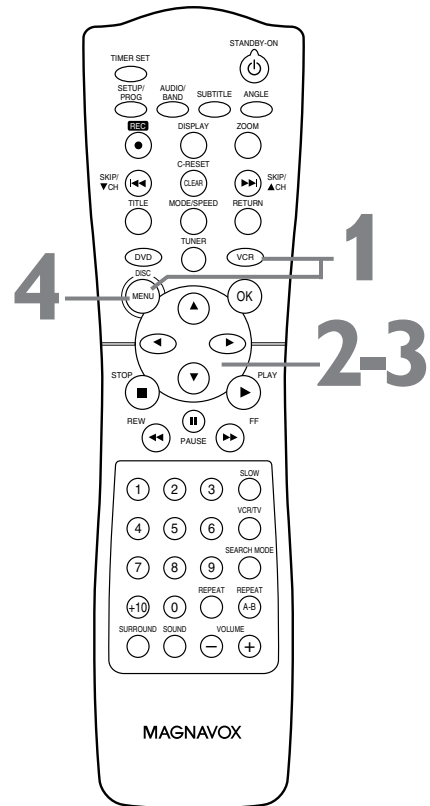

Helpful Hints

- Programs are recorded in both Hi-Fi stereo sound and in monaural sound.
- The audio level of a tape recorded in Hi-Fi stereo will differ from the audio level of a tape not recorded in Hi-Fi stereo.
- You can change to MONO if you want monaural audio playback. Choose MONO at step 3. HIFI will disappear from the status display.
- If you play non-Hi-Fi tapes while AUDIO OUT is set to HIFI, HIFI will not appear on the status display. The tape will play in monaural sound.

Please see additional notes on page 81.

Digital Sound, Surround Sound 49

Digital Sound

Digital Sound lets you enjoy special sound effects that have preset equalizer settings, providing the best music reproduction. The default setting of the System is OPTIMAL.

- 1 Press **SOUND** repeatedly to select **OPTIMAL**, **CLASSIC**, **POP**, or **JAZZ**. The selected Digital Sound light will appear on the front of the System.

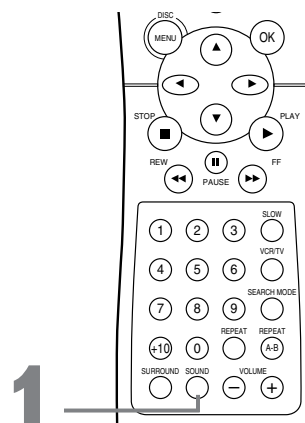

Surround Sound

For proper Surround Sound, connect the speakers and Subwoofer correctly. Details are on page 17. The Center and Rear (Surround) speakers only operate when Surround is On. The Discs or TV programs must be recorded or broadcast in Surround Sound.

- 1 Press **SURROUND** to set Surround to On or Off .
When Surround is On, the SURR (Surround) light will appear on the front of the System. When Surround is Off, the SURR (Surround) light will be off.
Programs broadcast in Stereo will produce some surround sound effects when played in a surround mode. However, non-Stereo programs will not have any sound at the Rear (Surround) speakers.

The following Surround Sound modes may be broadcast by DVDs or TV stations. You cannot alter these Surround Sound options at the System.

Matrix: Delivers sound through 5.1 Channels. You will have sound at all five speakers (Front Left and Right, Center, and Rear (Surround) Left and Right).

Dolby Digital: Dolby Digital is a high-quality audio compression technology first used in movies. This technology has since been adopted for use in Consumer Electronic products and allows you to enjoy the same type of sound in your home. Your player has a built-in Dolby Digital decoder so you can enjoy DVDs that include a Dolby Digital soundtrack. You can identify DVDs and equipment that contain Dolby Digital by looking for the following logo: 

Dolby Pro Logic: Dolby Pro Logic is a decoding technology that can be used to decode two channel material. Dolby Pro Logic decoding of two channel sources yields 4 output channels. These are : Left, Center, Right and a mono Surround channel.

DTS (Digital Theater System): Developed by Digital Theater Systems, Inc., of the United States. Sound is compressed to reduce its recording size. Since the compression level is less than Dolby Digital, the quantity of data is greater when decoded, providing clarity and depth in the sound. The sound has a wider dynamic range and higher resolution.

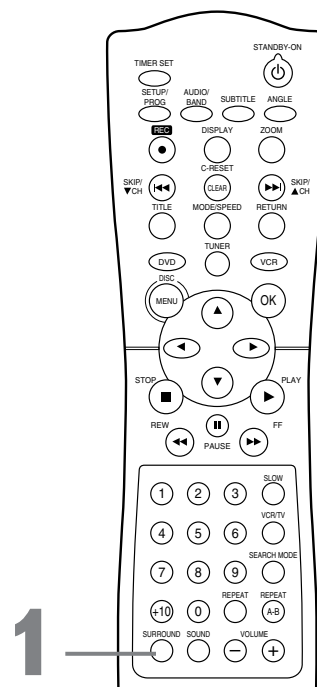

Helpful Hint

- Surround Sound is not available when you are using headphones. The SURR (Surround) light will turn off.

50 Delay Time

Set the delay time for the Center and Rear (Surround) speakers to suit your listening position. If you usually sit closer to the Center speaker than the Front speakers, increase the Center delay time to improve the Surround Sound effect. If you plan to sit closer to the Rear speakers than the Front speakers, increase the Rear delay time.

- 1** Press **DVD** to put the System in DVD mode. The red DVD light will be on the front of the System. Press **STOP** to stop Disc playback if necessary.
- 2** Press **SETUP/PROG**. The QUICK SETUP screen will appear.

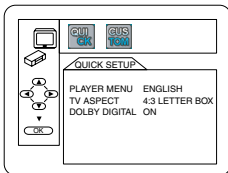

- 3** Press **▶** to select **CUSTOM** at the top of the menu, then press **OK**. This menu will appear.

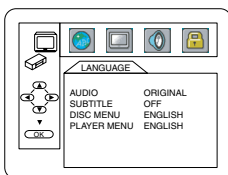

- 4** Press **▶** to select **AUDIO** (AUDIO) at the top of the menu, then press **OK**.

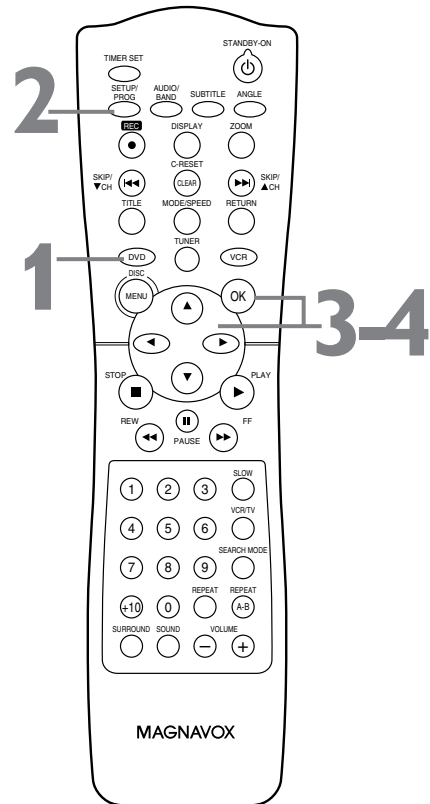
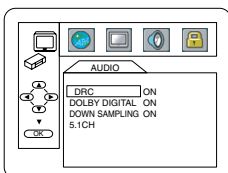

Delay Time (cont'd) 51

- 5** Press **▼** to select 5.1CH, then press **OK**.

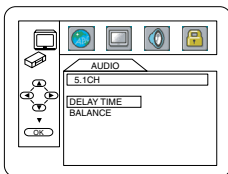

- 6** **DELAY TIME** will be selected. Press **OK**.

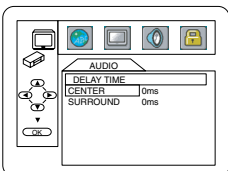

- 7** Press **▲** or **▼** to select **CENTER** or **SURROUND** (for the **REAR** speakers), then press **OK**.

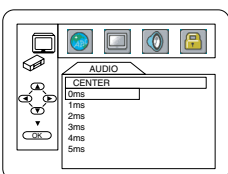

- 8** Press **▲** or **▼** to select a delay time in milliseconds, then press **OK**. The default setting for the **CENTER** Delay time is 0 ms. The default setting for the **SURROUND** (REAR) Delay time is 5 ms.

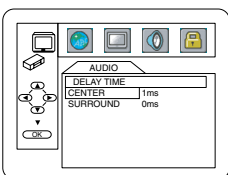

- 9** Press **SETUP/PROG** to remove the menu.

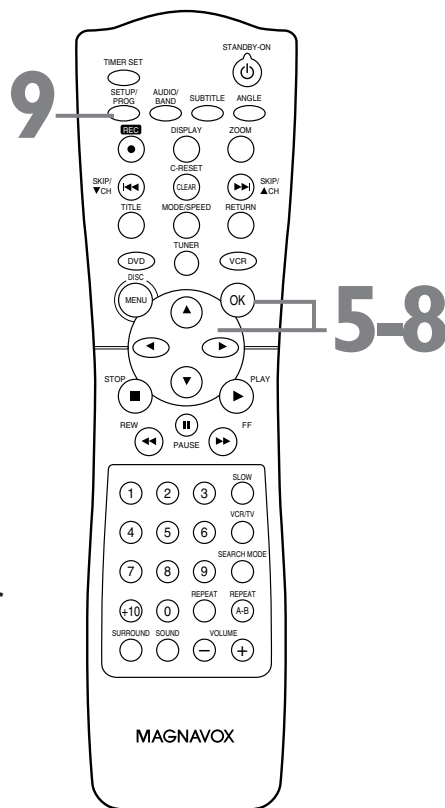

52 Speaker Balance

You can test the volume balance of each speaker with this procedure.

- 1 Press **DVD** to put the System in DVD mode. The red DVD light will appear on the front of the System. Press **STOP** to stop Disc play if necessary.

- 2 Press **SETUP/PROG**. The QUICK SETUP screen will appear.

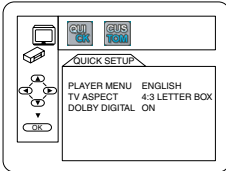

- 3 Press **▶** to select **CUSTOM** at the top of the menu, then press **OK**. This menu will appear.

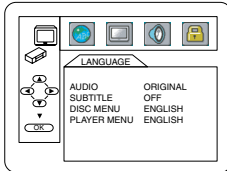

- 4 Press **▶** to select **AUDIO** at the top of the menu, then press **OK**.

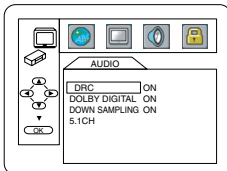

- 5 Press **▼** to select **5.1CH**, then press **OK**.

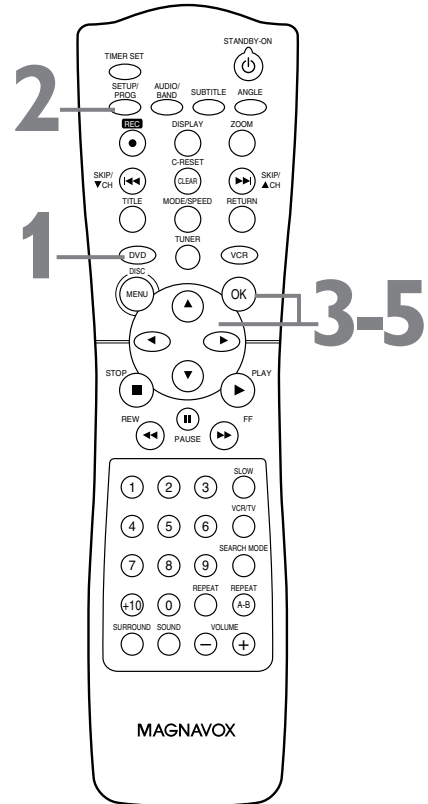
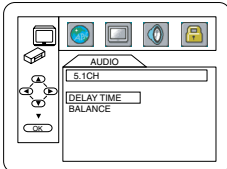

Speaker Balance (cont'd) 53

- 6** Press **▼** to select **BALANCE**, then press **OK**.

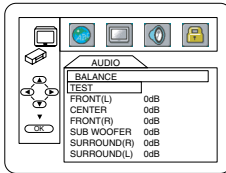

- 7** **TEST** will be selected. Press **OK**.
The test sound will come from each speaker (in the order indicated in the menu) so you can check the volume of each speaker.

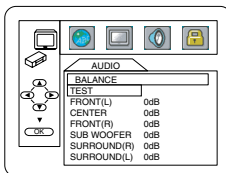

- 8** Press **OK** to stop the test.

- 9** Press **▲** or **▼** to select the speaker for which you want to adjust the volume, then press **OK**.
You will hear the test sound from that speaker.

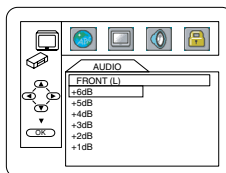

- 10** Press **▲** or **▼** to adjust the volume of the selected speaker, then press **OK**. The **BALANCE** menu will reappear, showing the value you selected for that speaker. The available volume range is -6 dB to +6 dB. Press **▲** or **▼** to see all the available dB values.

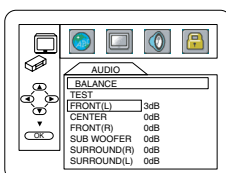

- 11** Press **SETUP/PROG** to remove the menu.

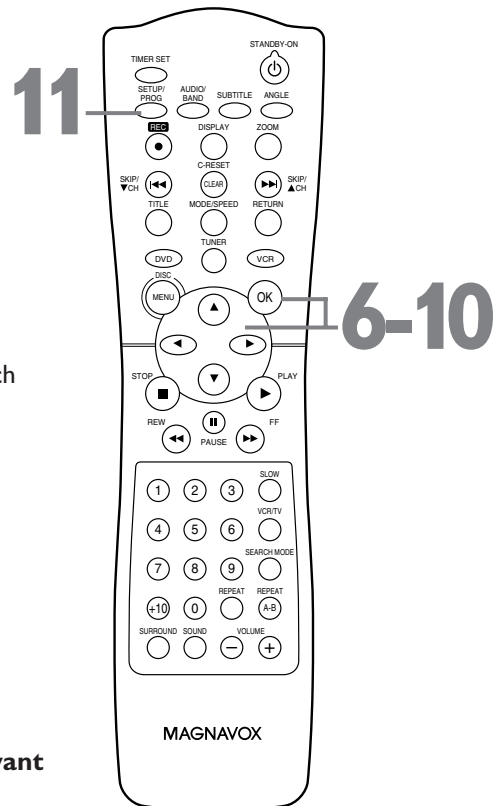

Helpful Hint

- You cannot hear the test sound from the Subwoofer.

54 DVD Disc Menus

DVDs contain menus that describe the contents of the DVD or allow you to customize DVD playback. For example, the menu may offer choices for subtitle languages, special features, or scene selection. To use the DVD Disc menu and select playback features, follow these steps.

- 1** Press **DVD** to put the System in DVD mode. The red DVD light will appear on the front of the System.
- 2** With a DVD in the System, press **DISC/MENU**. The DVD's main Disc menu will appear.
- 3** Press **▲**, **▼**, **◀**, or **▶** to select an item, then press **OK**. Continue this process to set up all the features you want or to start playing the DVD from the menu.

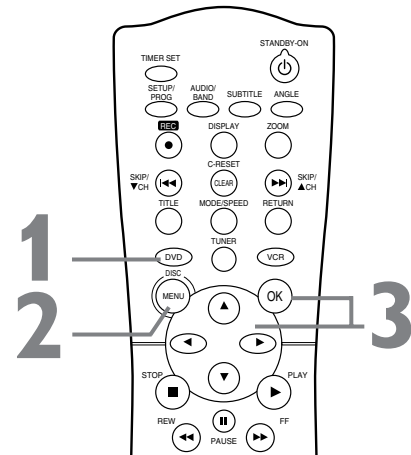

Using the Title Menu

Some DVDs have a Title Menu, which lists the Titles available on the DVD. Use the Title Menu to start playback at a specific Title.

- 1** Press **DVD** to put the System in DVD mode. The red DVD light will appear on the front of the System.
- 2** Press **TITLE**. The Title menu will appear. If a Title menu is not available, the "X" may appear on the TV screen. Or, if the DVD only has a main Disc menu as described above, it may appear when you press TITLE.
- 3** Press **▲**, **▼**, **◀**, or **▶** to select a Title, then press **OK**. Play will begin at the Title you selected.

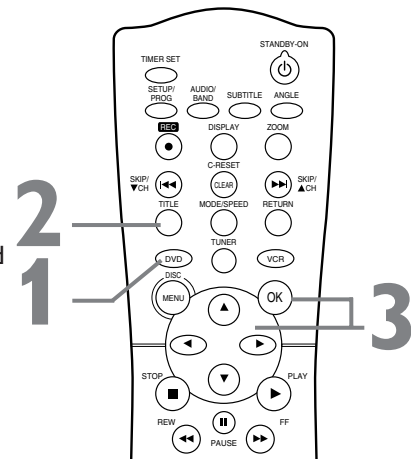

Helpful Hints

- Menus vary among DVDs. Follow the information accompanying the DVD.
- Not all DVDs have Title menus.
- Some DVDs may refer to Chapters as "scenes." Some DVDs may refer to the Title Menu as the "scene index."
- The TITLE button will not be active with all DVDs.

Fast Forward/Reverse Search 55

1 Press **DVD** to put the System in DVD mode. The red DVD light will appear on the front of the System.

2 During playback, press **FF** **▶▶** or **REW** **◀◀**. Use **FF** **▶▶** for a forward search. Press **REW** **◀◀** for a reverse search.

- During DVD playback, pressing **FF** **▶▶** or **REW** **◀◀** will forward or reverse the picture at two, eight, 50, or 100 times the normal playback speed. An **◀◀ 2**, **◀◀ 8**, **◀◀ 50**, or **◀◀ 100** will appear briefly on the TV screen to indicate reverse searching. Or, **▶▶ 2**, **▶▶ 8**, **▶▶ 50**, or **▶▶ 100** will appear briefly on the TV screen to indicate fast forward searching. Sound will be mute during searching.
- During Audio CD playback, you may search only at 16 times the normal playback speed. An **◀◀ 16** or **▶▶ 16** will appear briefly on the TV screen. Sound will be intermittent during searching on an Audio CD.
- During MP3 playback, you can search at only eight times the normal speed. An **◀◀ 8** or **▶▶ 8** will appear briefly on the TV.



Example: Playing a DVD in reverse at twice the normal playing speed.

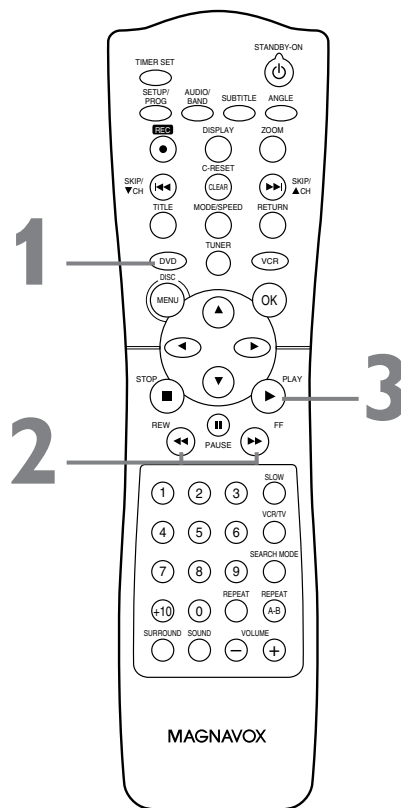

3 Press **PLAY** **▶** to return to normal playback.

56 Title/Chapter Playback, Time Playback

Title/Chapter Playback

- 1** With a DVD in the System, press **DVD**.
- 2** During DVD playback, press **SEARCH MODE** until CH (for Chapter) or TT (for Title) appears on the TV screen. The number of available Titles or Chapters will appear at the right (/4, for example).
- 3** Enter the Title or Chapter number using the **Number buttons**. The selected Title or Chapter will start to play.

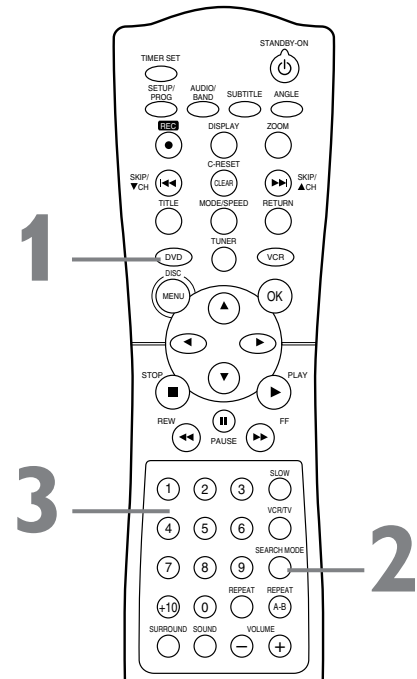
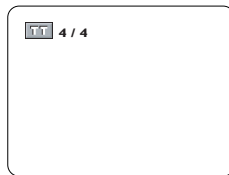

Time Playback

- 1** Press **DVD** to put the System in DVD mode.
- 2** During DVD or Audio CD playback, press **SEARCH MODE** until the Time Search display appears.

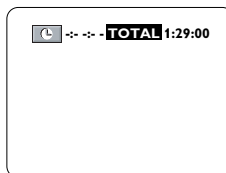

- 3** Within 30 seconds, use the **Number buttons** to enter the elapsed playing time (of the Track or Title) at which you want playback to begin. Enter the time in hours, minutes, and seconds. Within a few seconds, playback will start at the specified time.
 - Example: 1 hour, 23 minutes, and 30 seconds
1 → 2 → 3 → 3 → 0
 - Make sure the time you enter is within the total time of the current Title or Track. If it is not, the time space will clear and playback will continue at its current point. The total time available in the current Track or Title will appear at the right in the Time Search display.
 - If you make a mistake entering the time, press **C-RESET/CLEAR** to clear the time area. Enter the correct information.

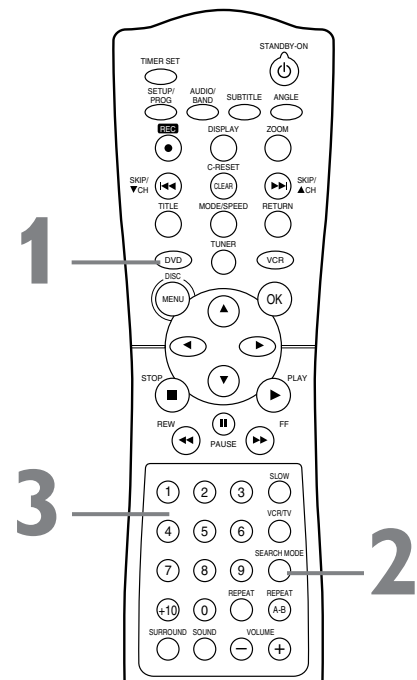

Helpful Hint

- Title/Chapter playback is not available with some DVDs.

Track Playback 57

There are three ways to play an Audio CD at a specific Track: Use the Number buttons, the SEARCH MODE button, or SKIP ►►/CH ▲ and SKIP ◀◀/CH ▼.

- Before you begin, press DVD so the red DVD light appears on the front of the System.

A

Using the Number Buttons

Press the Number buttons to enter a Track number. Play will start at the selected Track.

For single-digit Tracks (1-9), press a single Number button.

For Tracks 10 and above, press the +10 button so the Search display (TR - -) appears on the TV. Press the Number button of the first digit, then press the Number button of the second digit.

For example, to play Track 26, press +10, then Number 2, then Number 6.

If you enter a Track number that is not available on the Disc, playback will not begin (or the current Track will continue to play).

B

Using SEARCH MODE

Press SEARCH MODE so the Track Search display (TR) appears. Within 30 seconds, press the Number buttons to select the Track number. Playback will begin at the selected Track.

For a single-digit Track (1-9), enter a zero first. For example, to play Track 5, press 0, 5.

You do not have to use the +10 button in Search Mode for Tracks 10 and above.

C

Using SKIP ►►/CH ▲ or SKIP ◀◀/CH ▼

During playback, press SKIP ►►/CH ▲ to skip the current Track and move to the next Track. The Track number will appear briefly on the System's display panel.

During playback, press SKIP ◀◀/CH ▼ to return to the beginning of the current Track or press repeatedly to go to previous Tracks. The Track number will appear briefly on the System's display panel.

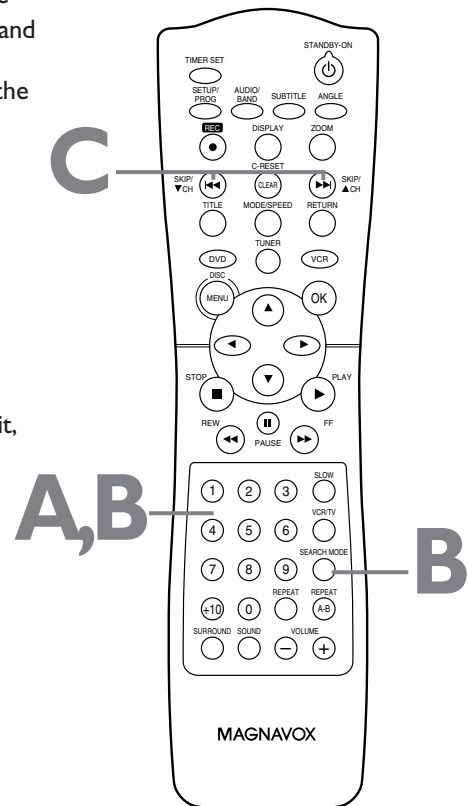

Helpful Hint

- You cannot use SKIP ►►/CH ▲ to go from the last Track on the Disc to the first Track.

58 Paused and Step-by-Step Playback, Resume

Paused and Step-by-Step Playback

- 1** Press **DVD** to make sure the System is in DVD mode.
- 2** During **Disc** playback, press **PAUSE** **||**. Play will pause and the sound will be muted.
- 3** When playing a **DVD**, press **PAUSE** **||** repeatedly to see the picture advance one frame (or step) at a time. The sound will remain mute. Pressing **PAUSE** **||** repeatedly during Audio CD, MP3, JPEG, or Picture CD playback will have no effect.
- 4** Press **PLAY** **▶** to resume playback.

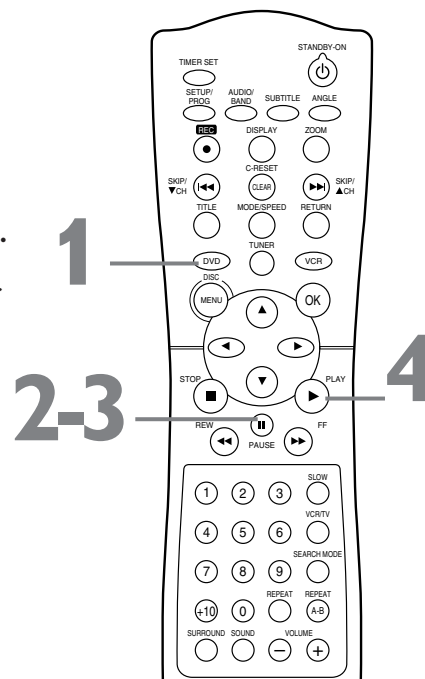

Resume

- 1** Press **DVD** to make sure the System is in DVD mode.
- 2** Press **STOP** **■** during **DVD** or **Audio CD** playback. In a few seconds, the following Resume message will appear on the TV screen. (The file list will appear when you stop Picture CD, MP3, or JPEG playback. Resume is not available.)

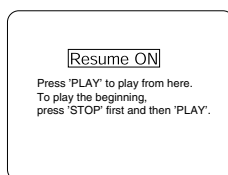

- 3** Press **PLAY** **▶**. In a few seconds, play will resume from the point at which it stopped last. You can resume play at the same point even if you turn off the System, then turn it on again later. However, opening the disc tray will cancel the Resume feature. Play will start at the beginning the next time you insert the Disc. To cancel Resume and start playing the Disc from the beginning, press **STOP** **■** a second time while playback is stopped. The Stop symbol (■) will appear briefly in the top right corner of the TV screen. Press **PLAY** **▶** to start playing the Disc from the beginning.

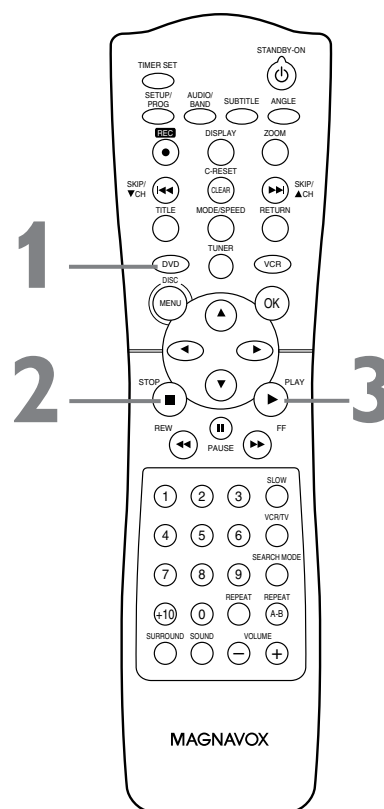

Repeat, A-B Repeat 59

Repeat

- 1** Press **DVD** to put the System in DVD mode.
- 2** During **DVD or Audio CD playback, press REPEAT until the repeat mode you want appears on the TV.**
On a DVD, select Chapter, Title, or Off.
On an Audio CD, select TRACK, ALL (all Tracks on the Disc), or OFF.
Selecting a new Track, Chapter, or Title will cancel repeat playback.



Example: Repeat a DVD Chapter

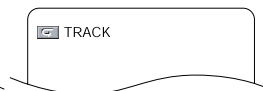

Example: Repeat an Audio CD Track

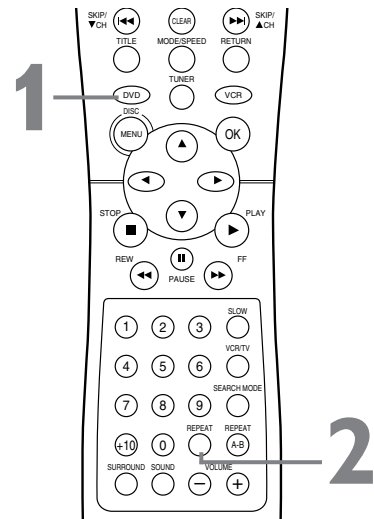

A-B Repeat

Follow these steps to play a section of a DVD or Audio CD repeatedly.

- 1** Press **DVD** to make sure the System is in DVD mode.
- 2** Press **PLAY ►** to play the Disc to the point at which you want repeated playback to begin.
- 3** Press **A-B REPEAT** to set the starting point (A). A - will appear on the TV screen briefly.
- 4** Play or fast forward the Disc to the point at which you want repeated playback to end, then press **A-B REPEAT** again. A-B will appear on the TV briefly. The section will begin to play repeatedly.
- 5** To cancel A-B Repeat, press **A-B REPEAT**. OFF will appear on the TV screen briefly. Regular play will resume.

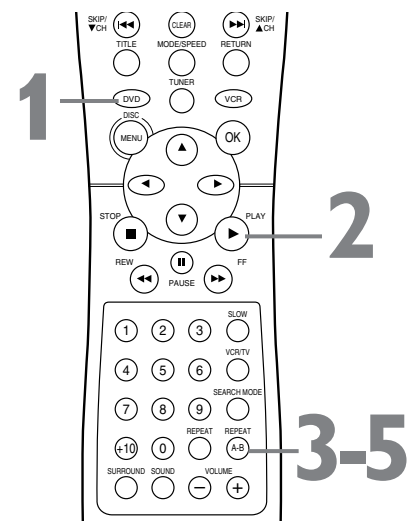

Helpful Hints

- Repeat playback and A-B Repeat are not available with all Discs.
- The entire A-B Repeat section must be within a single Title or Track. If you do not enter Point B before the end of the Track or Title is reached, the end of the Track or Title will become Point B automatically.
- Point B must be later on the Disc than Point A.

60 Markers

Use Markers to remember your favorite places on an Audio CD or DVD. To set the Markers, follow these steps.

- Before you begin, place the System in DVD mode. Press DVD so the red DVD light appears on the front of the System.

- 1 Play the Disc to within 30 seconds prior to the point at which you want to set the Marker. **During playback, press SEARCH MODE until the Markers appear at the top of the TV screen.**

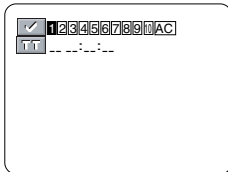

- 2 Within 30 seconds, press ◀ or ▶ to select a Marker (1-10). Make sure --:--:-- appears beneath the number.

- 3 Let the Disc play to the point at which you want to set the Marker (up to 30 seconds away). **When the Disc reaches the point you want to remember, press OK.** The Title number and elapsed playing time (DVD) or Track number and its elapsed playing time (Audio CD) will appear. The Markers will disappear after 30 seconds. Or, press SEARCH MODE again to remove them.

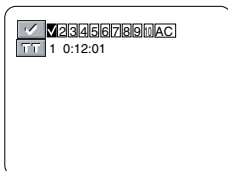

DVD example

- 4 To return to a Marker during playback, press SEARCH MODE until you see the Markers. Press ◀ or ▶ to choose the Marker you want, then press OK. Disc play will continue from the marked point.

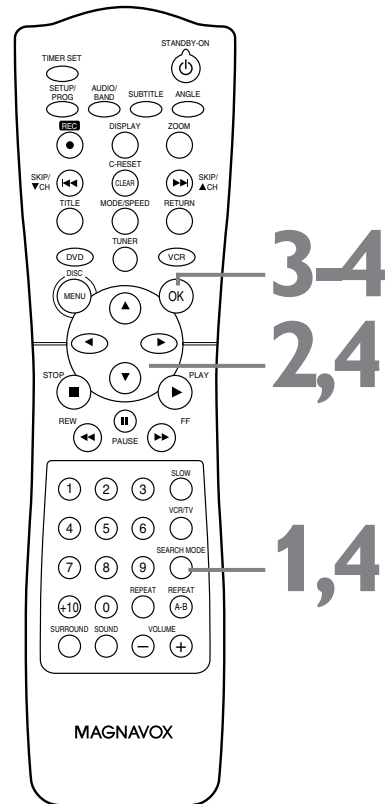

Helpful Hints

- Opening the disc tray or turning off the System will erase all the Markers.
- To erase a single Marker, press SEARCH MODE until you see the Markers. Press ◀ or ▶ to select a Marker. Press C-RESET/CLEAR. Press RETURN or SEARCH MODE to remove the Markers.
- To erase all the Markers, press SEARCH MODE until you see the Markers. Press ▶ to select AC, then press OK. Press SEARCH MODE or RETURN to remove the Markers.

Subtitles, Camera Angles 61

Subtitles

You can select a language for DVD subtitles during playback. You can select only languages that are available on the DVD.

1 Press DVD.

2 During playback, press SUBTITLE to select a subtitle language. The number of available languages appears at the right of the subtitle display. In the example below, six languages are available (/6). After a few seconds, the subtitles will appear.

Or, press SUBTITLE to turn off subtitles.



Example: English as first of six available subtitles.

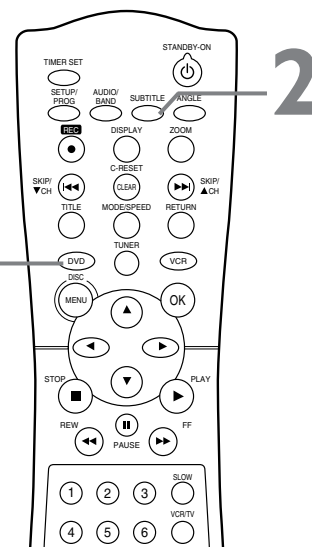

Camera Angles

Some DVDs contain scenes recorded from different angles. The camera angle will not change if the DVD does not contain sequences recorded from different camera angles.

1 Press DVD.

2 During playback, press ANGLE to select a different angle. The number of available angles appears at the right of the Angle display. In this example, eight angles are available (/8).

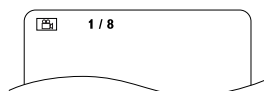

Example: Angle 1 of eight available angles.

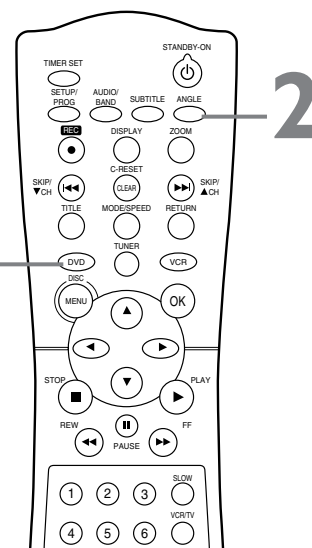

Helpful Hints

- On some DVDs, you must select a subtitle language in the Disc menu.
- If the language does not appear after pressing SUBTITLE several times, the Disc does not have subtitles in that language.
- Opening the disc tray will cancel your subtitle setting.
- If the current portion of the Disc has multiple camera angles,  will appear on the TV screen. ANGLE ICON must be ON. Details are on page 69.

62 Slow Motion, Zoom

Slow Motion

- 1 Press **PAUSE** **II** during DVD playback.
- 2 Press **FF** **▶▶** or **REW** **◀◀**. Slow motion playback will begin. Press **FF** **▶▶** or **REW** **◀◀** repeatedly during slow motion playback to play the DVD forward or backward at 1/16, 1/8, or 1/2 the normal speed.



Example: Playing a DVD forward at half the normal speed.

- 3 Press **PLAY** **▶** to return to normal playback.

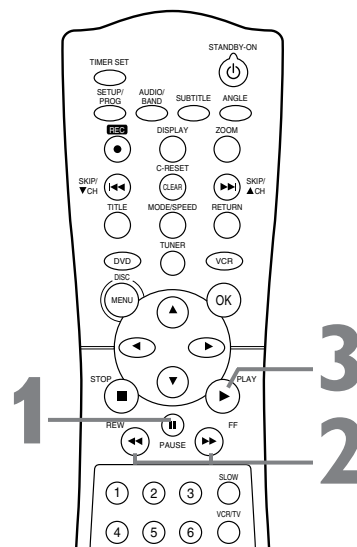

Zoom

You can enlarge the DVD picture to two or four times larger than normal.

- 1 Press **ZOOM** during playback or when play is paused. The picture will appear twice as large. Press **ZOOM** again to make the picture four times as large as normal. Either x2 or x4 will appear beside the zoom icon in the top left corner of the TV screen.
- 2 While the picture is enlarged, press **▲**, **▼**, **◀**, or **▶** to move the zoomed image up, down, left, or right. The gray box with an inner blue box that shows during Zoomed playback is the position guide. To remove it or show it, press **OK**. The position of the blue box inside the gray box indicates the position of the zoomed image within the overall picture.

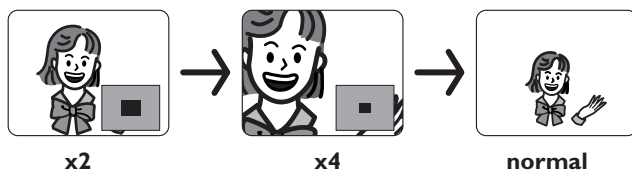

- 3 To return the picture to normal, press **ZOOM**.

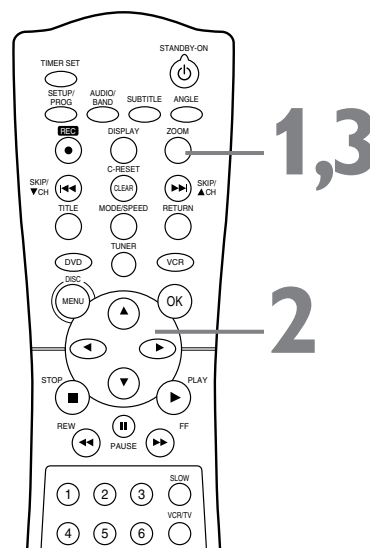

Helpful Hints

- The sound will be mute during slow motion playback.
- The **SLOW** button on the remote does not activate slow motion of DVDs.
- The x4 zooming is not active with some Discs. Only x2 zooming is available for JPEGs or a Picture CD.

Programs, Random Play 63

Programs

You may determine the order in which Audio CD Tracks will play. You also can program MP3 or JPEG files to play in a special order, including those on a Picture CD. To set a Program, follow these steps.

- 1** Press **DVD** to make sure the System is in DVD mode.
- 2** While play is stopped, press **MODE/SPEED**. The PROGRAM screen will appear.

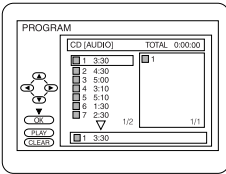

Example: Audio CD

- 3** Press **▲** or **▼** to select a Track you want to play, then press **OK**. Tracks that are in the Program appear on the right half of the screen. Press **C-RESET/CLEAR** to erase the last Track in the Program if you make an error. Repeat this step until you have selected all the Tracks you wish to play in the Program.
- 4** Press **PLAY ▶**. The Tracks will play once in the order you set. Turning off the System or opening the disc tray will erase the Program.

Random Play

You may play the Tracks of an Audio CD in Random order instead of the order in which they are recorded (1,2,3...). You can also use this feature for JPEG and MP3 files, including those on a Picture CD.

- 1** Press **DVD** to put the System in DVD mode. The red DVD light will appear on the front of the System.
- 2** While playback is stopped, press **MODE/SPEED** twice so the **RANDOM** screen appears.

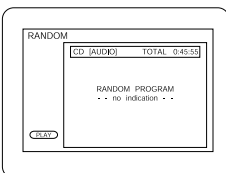

Example: Audio CD

- 3** While the **RANDOM** screen appears, press **PLAY ▶**. The Tracks will play in random order. After all the Tracks have played once, playback will stop.

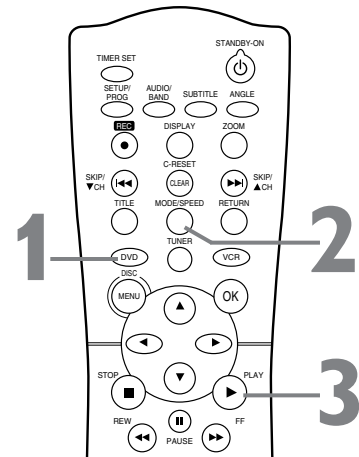
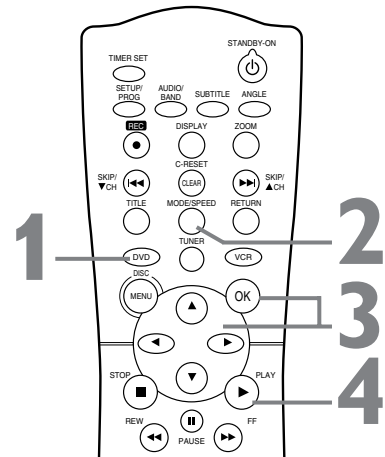

Helpful Hints

- You cannot use the Number buttons or SEARCH MODE to select another Track while playing a Program. Use SKIP ▶▶▶/CH ▲ or SKIP ◀◀◀/CH ▼ to select other Tracks within the Program.
- You cannot combine random playback with programmed playback.
- You may play a Program or a Track within a Program repeatedly. During programmed playback, press REPEAT so ALL (all Tracks in the Program) or TRACK appears. The entire Program or the current Track will play over and over.
- You cannot alter a Program during playback.
- You can start Program play only while in the PROGRAM screen.
- A Program can have a maximum of 99 Tracks.

64 Parental Controls Password

Parental Controls prevents viewing of DVDs that exceed your rating limits. This feature will not limit viewing if the DVD is not rated or coded. Check your DVDs and settings before letting children access the System. Follow these steps to change your password.

- 1** Press **DVD** to put the System in DVD mode. The red DVD light will be on. Press **STOP** to stop Disc playback.
- 2** Press **SETUP/PROG.**
- 3** Press **▶** to select **CUSTOM** at the top of the menu, then press **OK**. The following menu will appear.

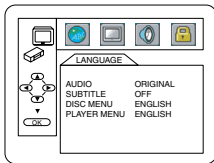

- 4** Press **▶** to select **Ⓐ** (the lock), then press **OK**. The first time you set a password, this menu will appear.

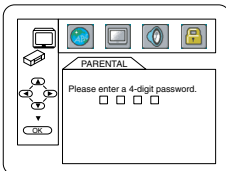

Press the **Number** buttons to enter a **four-digit password**. The password will appear on the screen. Write it down so you don't forget it.

Press **OK**. You are finished! Go to step 7.

If you have set a password before, this menu will appear.

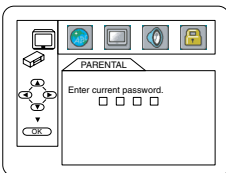

Press the **Number** buttons to enter your **current four-digit password**. Asterisks (*) will appear instead of your password. This protects its identity.

- 5** Press **▼** to select **CHANGE**, then press **OK**.

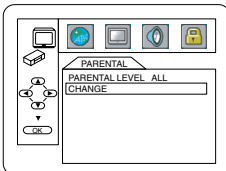

- 6** Press the **Number** buttons to enter a **four-digit password**. The password numbers will appear on the screen. Write down the password so you will not forget it. Press **OK**. The previous menu will reappear.

- 7** Press **SETUP/PROG** to remove the menu.

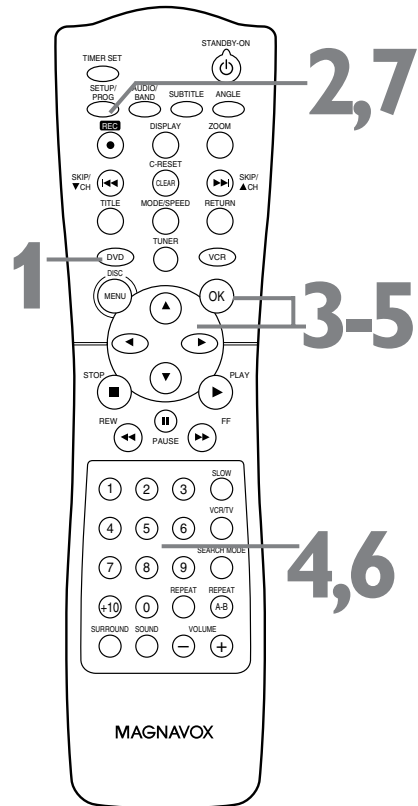

Helpful Hints

- The default password is 4737. If you forget your password, press Number buttons 4, 7, 3, 7 at step 4. You will be prompted to enter a new four-digit password. Use the Number buttons to enter a new four-digit password, then press OK. PARENTAL LEVEL will reset to ALL. See page 65 to reset PARENTAL LEVEL as you desire.
- A power failure will not erase your password.

Parental Levels 65

Follow these steps to set the rating level for your DVDs. DVDs whose ratings exceed the level you set will not play.

1 Press **DVD** to put the System in DVD mode. The red DVD light will be on. Press **STOP** to stop Disc playback if necessary.

2 Press **SETUP/PROG**. The QUICK SETUP screen will appear.

3 Press **▶** to select **CUSTOM** at the top of the menu, then press **OK**. This menu will appear.

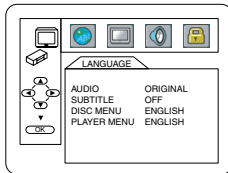

4 Press **▶** to select **LOCK** (the lock), then press **OK**.

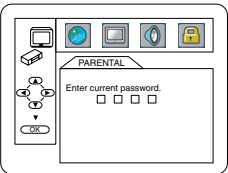

5 Press the **Number** buttons to enter your four-digit password.

6 **PARENTAL LEVEL** will be selected. Press **OK**.

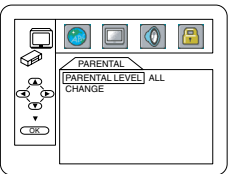

7 Press **▲** or **▼** to select a level, then press **OK**. The rating levels continue on two menu screens. Press **▲** or **▼** repeatedly to move to the next or previous screen to find the rating level you want.

After making your selection, the previous menu will appear. The level you selected will appear beside **PARENTAL LEVEL**.

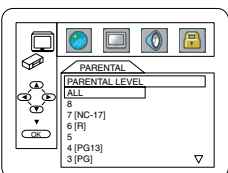

8 Press **SETUP/PROG** to remove the menu.

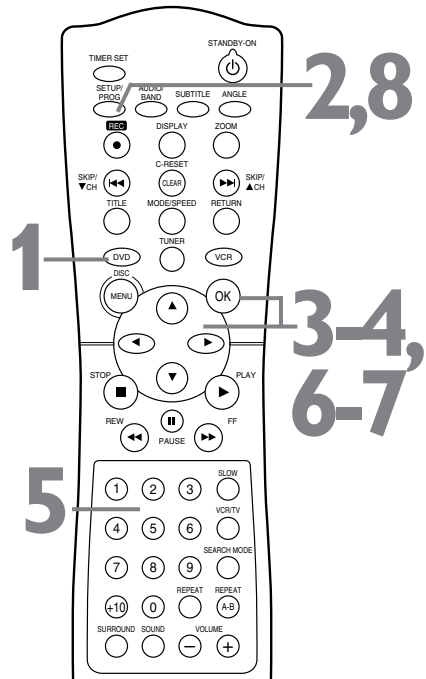

RATING EXPLANATIONS

- ALL - Parental Controls is inactive; all discs can play.
- 8 - Adult material
- 7 - NC-17 - Not appropriate for children under 17
- 6 - R - Restricted; parental approval required for viewers under 18.
- 4 - PG13 - Unsuitable for children under 13
- 3 - PG - Parental Guidance suggested.
- 1 - G - General Audience; recommended for all ages.

Helpful Hints

- When you try to play a DVD whose rating exceeds the level you set, an on-screen message will indicate the DVD cannot play. Remove the DVD, then set **PARENTAL LEVEL** to **ALL**. Reload the DVD and begin playback. Some DVDs may let you enter your four-digit password to begin playback. Follow the on-screen messages as prompted.
- You cannot use the default password (4737) to play a DVD.

66 Audio Language, Stereo Sound

Audio Language

You can select a language for DVDs during playback if multiple languages are available.

- 1 Press **DVD** to put the System in DVD mode. The red DVD light will appear on the front of the System.
- 2 During DVD playback, press **AUDIO/BAND** repeatedly to choose one of the available languages. The new audio will be heard. The display will disappear after about five seconds.

The Audio display may show if the DVD has Dolby Digital or multi-channel (5.1 ch) sound or its sampling rate (48 k, for example). The number of available languages appears after the “ / ” at the right of the display (/3, for example).

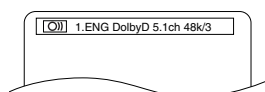

Example: English audio

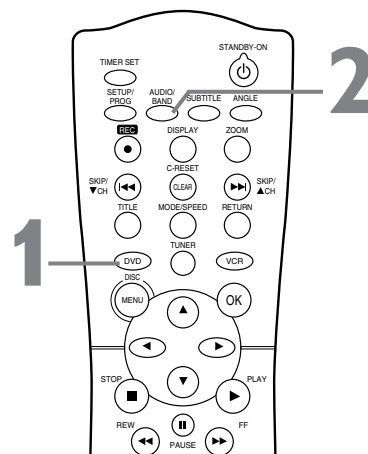

Stereo Sound

If you connected the System to a Stereo using the DIGITAL AUDIO OUT COAXIAL jack as described on page 15, you cannot adjust Stereo Sound. Otherwise, adjust Stereo Sound to determine whether you will hear the left channel, the right channel, or both channels (stereo) during Audio CD playback.

- 1 Press **DVD** to put the System in DVD mode. The red DVD light will appear on the front of the System.
- 2 Press **AUDIO/BAND** during Audio CD playback to choose **STEREO**, **L-CH**, or **R-CH**.

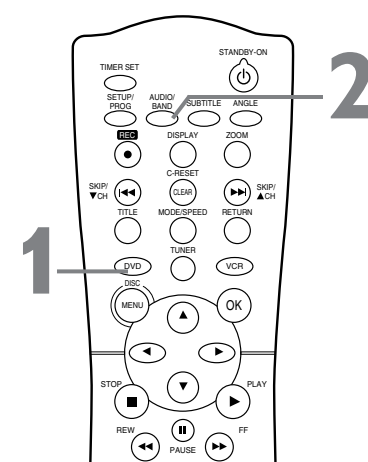
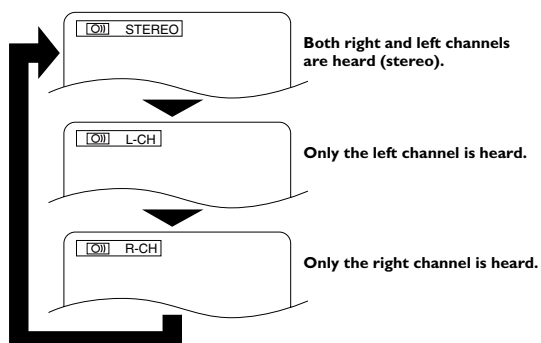

Helpful Hints

- If a language is not available after pressing **AUDIO/BAND** several times, the DVD does not have that language.
- Some DVDs only let you change the language in the Disc menu.
- Audio languages may be abbreviated (such as **ENG** for English). Or, three dashes (---) may appear instead of an abbreviation.

MP3/JPEG/Picture CD Playback 67

The DVD Player will play MP3 or JPEG files that you record and finalize on a CD-RW (Compact Disc-Rewritable) or CD-R (Compact Disc-Recordable).

These Discs may contain pictures in a JPEG format or audio Tracks in an MP3 format. For example, you may have photographic film developed by a retailer that places the pictures on a CD-R (or Picture CD) for you. These pictures may be in JPEG format.

Or, you may copy or download MP3 music files from certain legal Internet sites, then copy those files onto a CD-R or CD-RW. You cannot make or record such Discs using this System. See your computer manual for details on recording.

Keep these characteristics in mind when making Discs you intend to play on the DVD Player of this System.

- Record MP3 Tracks at a sampling frequency of 44.1 kHz or 48 kHz. Use a bit rate between 112 kbps and 320 kbps.
- When recording JPEG Files, the size of the picture should be between 32 x 32 and 6300 x 5100 dots.

- 1 Press DVD** to put the System in DVD mode. The red DVD light will appear on the front of the System.
- 2 Put a Disc in the DVD Player of the System.** When you put a CD-RW or CD-R with MP3 or JPEG files in the System, the File List will appear on the TV screen.
- 3 Press ▲ or ▼ to select a Folder, MP3 Track, or JPEG File.** If you select a Folder, press OK. The Tracks or Files within that Folder will appear. Press ▲ or ▼ to select the Track or File you want.
 - Choose FIRST PLAY to start play at the first individual File or Track listed.
 - Press TITLE to return to the first item on the first screen.
- 4 After choosing a Track or File, press PLAY ► or OK.** Starting with the Track or File you selected, the Tracks/Files will play in the order they were recorded, i.e. 1, 2, 3.
 - During JPEG or Picture CD playback, press MODE/SPEED so JPG 1 or JPG 2 appears in the top left corner of the TV screen. Within five seconds, press OK repeatedly to choose JPG 1 or JPG 2. Choose JPG 1 to have the pictures cut in and out sharply. Choose JPG 2 to have the pictures fade in and out softly.
- 5 To stop playback, press STOP ■.**

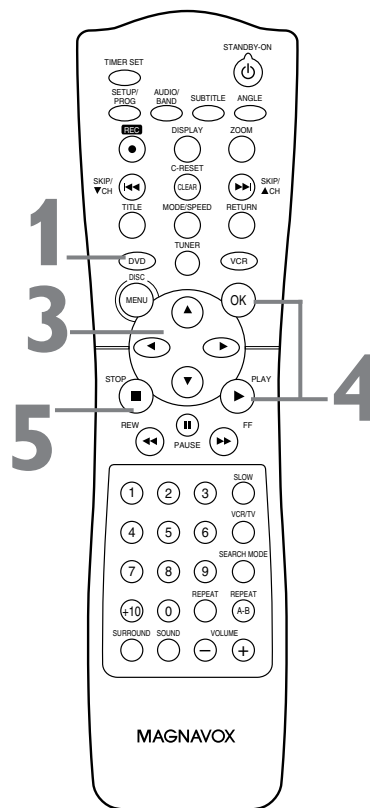

Helpful Hints

- JPEG images and MP3 Tracks are known as Files. Groups of Files are called Folders.
- JPEG Files have the ☺ icon.
- A maximum of 255 Folders can be recognized. A maximum of 256 Files can be recognized.
- MP3 Files have the 3J icon.
- During playback, press the Number buttons to select another Track. If a Track is not available, "X" will appear on the TV screen. Or, press SKIP ►►/CH ▲ or SKIP ◀◀/CH ▼ to change Tracks.
- Press ► or ◀ to rotate a JPEG image.
- To access or remove the File List during playback, press SEARCH MODE. The current Track will be highlighted.

68 MP3/JPEG/Picture CD Displays

You can review MP3, JPEG, and Picture CD information during playback.

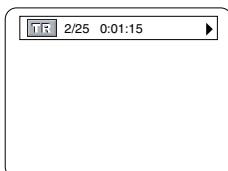

- Before you begin, make sure the System is in DVD mode. Press DVD so the red DVD light appears on the front of the System.

- 1 Press DISPLAY during playback.** The current Track/File name will show on the TV screen.
- 2 Press DISPLAY again.** The current Track/File number, total Tracks/Files available, and elapsed playing time of the current Track (MP3 only) will appear.



MP3 example

Or, the following may appear to indicate Repeat play.

-  T: The current Track is playing repeatedly.
-  G: Tracks in the current Folder (Group) are playing repeatedly.
-  A: All Tracks are playing repeatedly.

- 3 Press DISPLAY again to remove the display.**

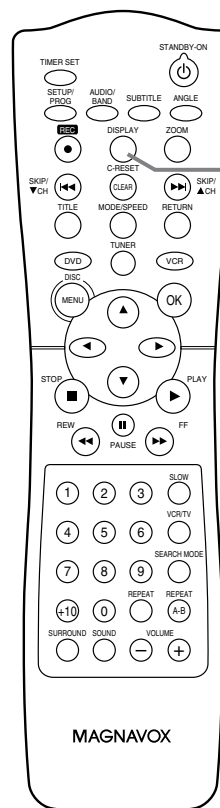

1-3

Display 69

You can change the TV Aspect, Angle Icon, and Automatic Power Off features of the DVD Player in the Display menu.

- 1** Press **DVD** to put the System in DVD mode. The red DVD light will appear on the front of the System.
- 2** When Disc play is stopped, press **SETUP/PROG**. The QUICK SETUP screen will appear.
- 3** Press **▶** to select **CUSTOM** at the top of the menu, then press **OK**. This menu will appear.

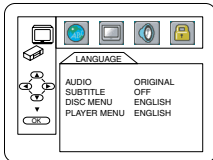

- 4** Press **◀** or **▶** to select **DISP** (display), then press **OK**.

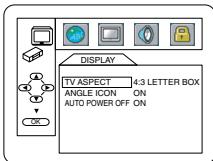

- 5** Press **▲** or **▼** to select an item, then press **OK**.
 - If you selected **TV ASPECT**, press **▲** or **▼** to select a setting, then press **OK**.
Choose 4:3 LETTER BOX if you want to see the entire, widened picture with black bars at the top and bottom of the screen. This looks like the picture you see when watching movies in a theater. This setting is possible only if the DVD was recorded in the letterbox or widescreen format. Choose 4:3 PAN & SCAN for a full height picture, with both sides trimmed. Some companies refer to this as reformatting the picture to fit your TV screen and may call it the regular or normal format. Choose 16:9 WIDE if a widescreen TV is connected to the System.
 - If you selected **ANGLE ICON**, press **OK** repeatedly to turn ANGLE ICON ON or OFF. The default setting is ON. Choose ON to see the Angle icon when multiple camera angles are available during DVD playback. Details are on page 61. Choose OFF to disable the Angle icon.
 - If you selected **AUTO POWER OFF**, press **OK** repeatedly to set AUTO POWER OFF to ON or OFF. The default setting is ON. Choose ON if you want the System to switch to VCR mode automatically if there is no activity at the DVD Player for 35 minutes.

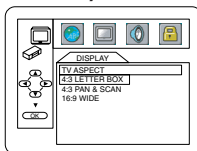

TV ASPECT

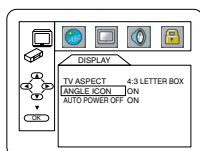

ANGLE ICON

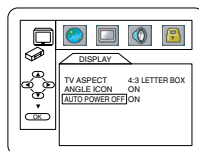

AUTO POWER OFF

- 6** Press **SETUP/PROG** to remove the menus.

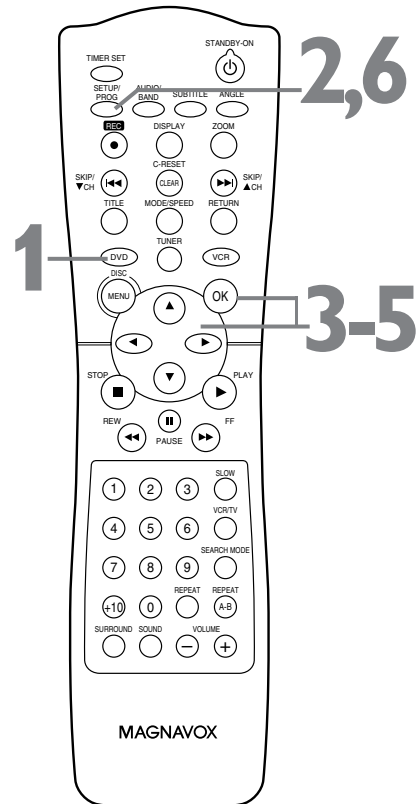

Helpful Hints

- Selecting a different TV ASPECT setting is only effective if it is available on the DVD. Check the DVD Disc menu or case for details.
- You also can adjust TV ASPECT in the QUICK SETUP menu that appears when you first press the SETUP/PROG button. With QUICK selected, press OK. Press ▼ to select TV ASPECT, then press OK. Press ▲ or ▼ to choose a setting, then press OK. Press SETUP/PROG to remove the menu.

70 Language

You can use the LANGUAGE settings to select different languages for the Audio or Subtitles of DVDs, as well as languages for DVD Disc menus and the menus of the DVD Player SETUP menus.

- 1 Press **DVD** to put the System in DVD mode. The red DVD light will appear on the front of the System.
- 2 While playback is stopped, press **SETUP/PROG**. The QUICK SETUP screen will appear.
- 3 Press **▶** to select **CUSTOM** at the top of the menu, then press **OK**. This menu will appear:

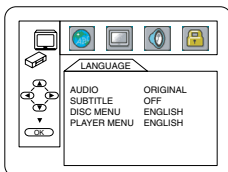

- 4 The Language menu () will be selected. Press **OK**.

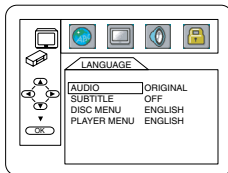

- 5 Press **▲** or **▼** to select **AUDIO**, **SUBTITLE**, **DISC MENU**, or **PLAYER MENU**. Then, press **OK**. The language options for the selected item will appear:

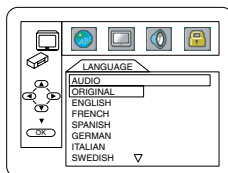

AUDIO: The DVD's audio plays in the selected language.

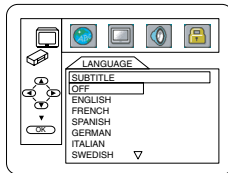

SUBTITLE: Subtitles appear in the chosen language.

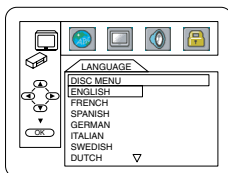

DISC MENU: A DVD's Disc menu appears in the chosen language.

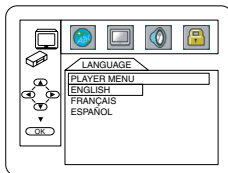

PLAYER MENU: The DVD Player's Setup menu can be in English, French, or Spanish only.

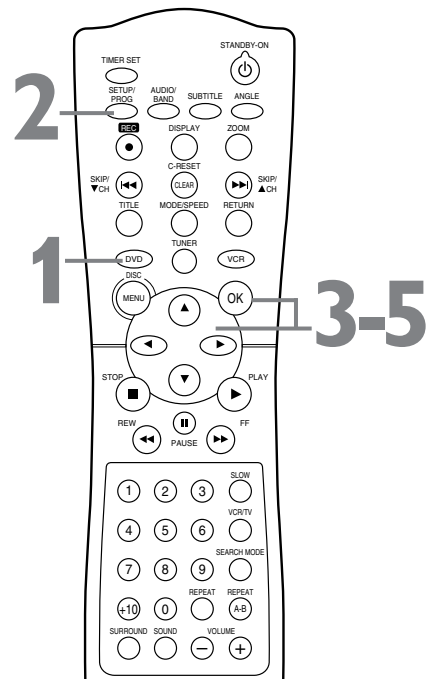

Helpful Hints

- If the DVD's default settings for Audio and Subtitle are the same language, the subtitles may not show unless you turn them on.
- Use the **AUDIO/BAND** and **SUBTITLE** buttons to select Audio and Subtitles available on the DVD. Details are on pages 61 and 66.
- Set **AUDIO** to **ORIGINAL** to play the default setting of the DVD.
- If you set **PLAYER MENU** to French or Spanish and need English: Follow steps 1-3. At step 4, the **IDIOMA** or **LANGUE** menu will appear. Press **OK**. Press **▼** to select **MENU DU LECTEUR** or **MENU REPRODUC.**, then press **OK**. Press **▲** to select **ENGLISH**, then press **OK**. The menus will change to English. Press **SETUP/PROG** to remove the menus.
- You can change the **PLAYER MENU** language in the **QUICK SETUP** menu that appears when you first press **SETUP/PROG**. With **QUICK** selected, press **OK**. **PLAYER MENU** will be selected. Press **OK**. Press **▲** or **▼** to choose a language, then press **OK**. Press **SETUP/PROG** to remove the menu.

Language (cont'd) 71

6 Press **▲** or **▼** to select a language, then press **OK**. The language list continues on multiple screens. Press **▲** or **▼** to move to the other screens if necessary to find your language.

- If you select **OTHER** for **AUDIO**, **SUBTITLE**, or **DISC MENU**, press **four Number buttons to enter the code for the language you desire**. Use the Language Codes below. The language or language code you select will appear in the Language menu beside **AUDIO**, **SUBTITLE**, or **DISC MENU**.

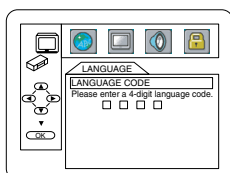

- You can select other languages for **AUDIO**, **SUBTITLE**, and **DISC MENU** only if the language is available on the Disc. If the language you select is not recorded on the DVD, changing these settings will have no effect.

7 Press **SETUP/PROG** to remove the menu.

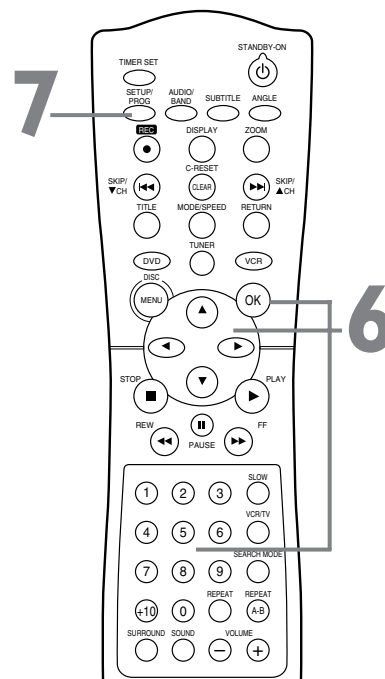

Language Codes

A-B	Dutch	6058	Japanese	5647	O-R	Spanish	5165
Abkhazian	English	5160	Javanese	5669	Occitan	Sundanese	6567
Afar	Esperanto	5161	Kannada	5760	Oriya	Swahili	6569
Afrikaans	Estonian	5166	Kashmiri	5765	Oromo (Afan)	Swedish	6568
Albanian			Kazakh	5757	Panjabi		
Amharic	F-H		Kinyarwanda	6469	Pashto	T	
Arabic	Faroese	5261	Kirghiz	5771	Persian	Tagalog	6658
Armenian	Fiji	5256	Kirundi	6460	Polish	Tajik	6653
Assamese	Finnish	5255	Korean	5761	Portuguese	Tamil	6647
Aymara	French	5264	Kurdish	5767	Pushto	Tatar	6666
Azerbaijani	Frisian	5271			Quechua	Telugu	6651
Bangla	Gaelic (Scots)	5350	L-N		Rhaeto-Romance	Thai	6654
Bashkir	Galician	5358	Laothian	5861	Romanian	Tibetan	4861
Basque	Georgian	5747	Latin	5847	Russian	Tigrinya	6655
Bengali	German	5051	Latvian	5868		Tonga	6661
Bhutani	Greek	5158	Lettish	5868	S	Tsonga	6665
Bihari	Greenlandic	5758	Lingala	5860	Samoan	Turkish	6664
Bislama	Guarani	5360	Lithuanian	5866	Sangho	Turkmen	6657
Breton	Gujarati	5367	Macedonian	5957	Sanskrit	Twì	6669
Bulgarian	Hausa	5447	Malagasy	5953	Serbian		
Burmese	Hebrew	5569	Malay	5965	Serbo-Croatian	U-Z	
Byelorussian	Hindi	5455	Malayalam	5958		Ukrainian	6757
	Hungarian	5467	Maltese	5966	Sesotho	Urdu	6764
C-E			Maori	5955	Setswana	Uzbek	6772
Cambodian	I-K		Marathi	5964	Shona	Vietnamese	6855
Catalan	Icelandic	5565	Moldavian	5961	Sindhi	Volapuk	6861
Chinese	Indonesian	5560	Mongolian	5960	Singhalese	Welsh	4971
Corsican	Interlingua	5547	Nauru	6047	Siswat	Wolof	6961
Croatian	Interlingue	5551	Nepali	6051	Slovak	Xhosa	7054
Czech	Inupiak	5557	Norwegian	6061	Slovenian	Yiddish	5655
Danish	Irish	5347			Somali	Yoruba	7161
	Italian	5566				Zulu	7267

72 Audio

Change Audio settings based on other equipment you connected to the System or according to your Disc sound features. These settings only affect the Disc Audio playback from the DVD Player of the System.

- 1** Press **DVD** to put the System in DVD mode. The red DVD light will appear on the front of the System.
- 2** While playback is stopped, press **SETUP/PROG**. The QUICK SETUP screen will appear.
- 3** Press **▶** to select **CUSTOM** at the top of the menu, then press **OK**. This menu will appear.

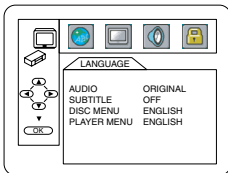

- 4** Press **▶** to select **AUDIO** () at the top of the menu, then press **OK**.

- 5** Press **▲** or **▼** to select **DRC**, **DOLBY DIGITAL**, or **DOWN SAMPLING**, then follow step 6 accordingly. Select 5.1 CH when you want to balance the System's speakers or adjust the Delay Times. *Details are on pages 50-53.*

- 6**
 - If you selected **DRC**, press **OK** repeatedly to turn Dynamic Range Control (DRC) On or Off. Choosing **ON** compresses the range of volume by suppressing loud sounds and raising low sounds.
 - If you selected **DOLBY DIGITAL**, press **OK** repeatedly to select **ON** or **OFF**. Select **ON** if you used the **DIGITAL AUDIO OUT COAXIAL** jack to connect the System to a stereo that is Dolby Digital compatible. *Details are on page 15.* Otherwise, choose **OFF**.
 - If you selected **DOWN SAMPLING**, press **OK** repeatedly to choose **ON** or **OFF**. Choose **ON** to set downsampling to 48 kHz. Choose **OFF** to set downsampling to 96 kHz.

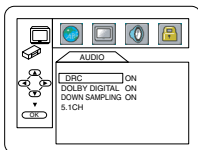

DRC

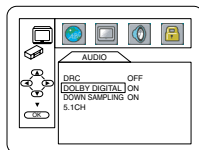

DOLBY DIGITAL

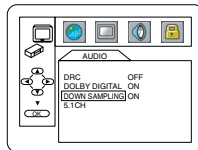

DOWN SAMPLING

- 7** Press **SETUP/PROG** to remove the menu.

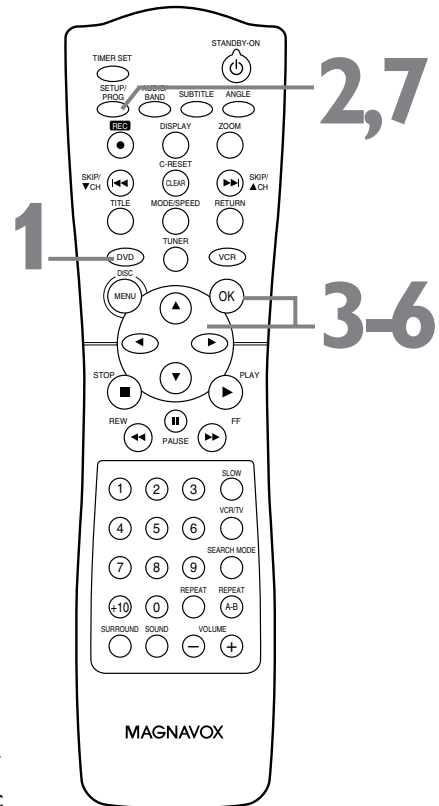

Helpful Hints

- Dolby Digital sound must be available on the DVD.
- You can adjust **DOLBY DIGITAL** in the **QUICK SETUP** menu that appears when you first press **SETUP/PROG**. With **QUICK** selected, press **OK**. Press **▼** to select **DOLBY DIGITAL**. Press **OK** to choose **ON** or **OFF**. Press **SETUP/PROG** to remove the menu.
- When you play a Disc that has copyright protection, downsampling will be at 48 kHz, even if you set **DOWN SAMPLING** to **OFF**.

On-Screen Displays 73

DVD Display

- 1 Press **DVD** to put the System in DVD mode. The red DVD light will appear on the front of the System.
- 2 Press **DISPLAY** repeatedly to see the following displays during DVD playback.

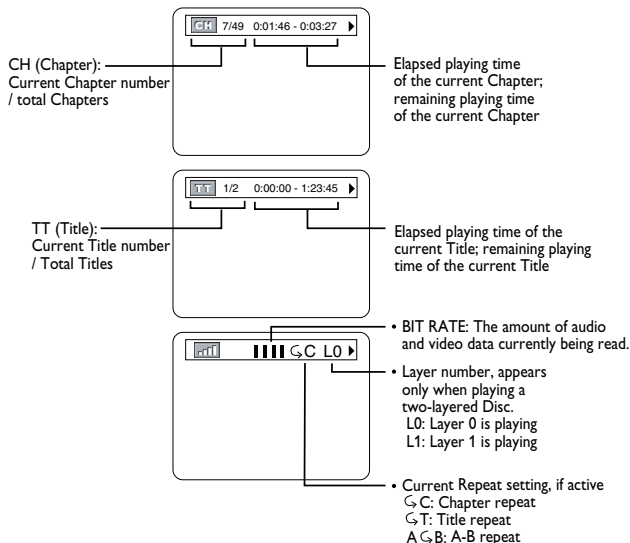

- 3 Press **DISPLAY** repeatedly or press **RETURN** to remove the display.

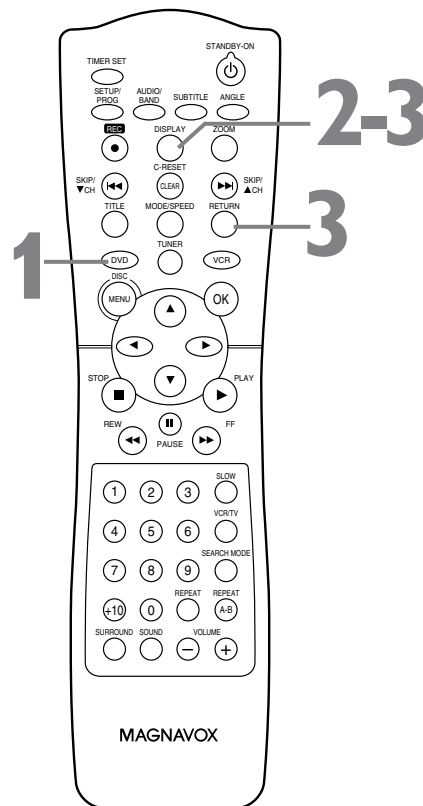

Audio CD Display

- 1 Press **DVD** to put the System in DVD mode. The red DVD light will appear on the front of the System.
- 2 Press **DISPLAY** repeatedly to see the following displays during Audio CD playback.

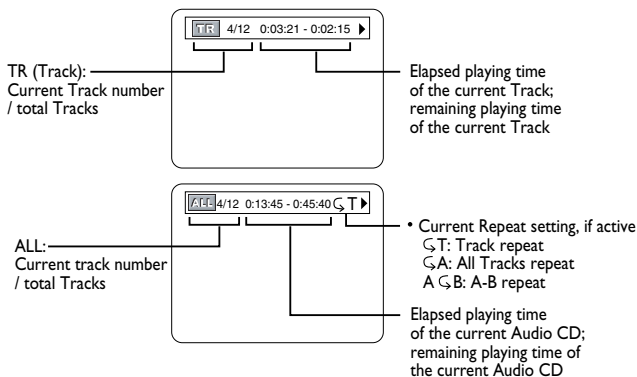

- 3 Press **DISPLAY** repeatedly or press **RETURN** to remove the display.

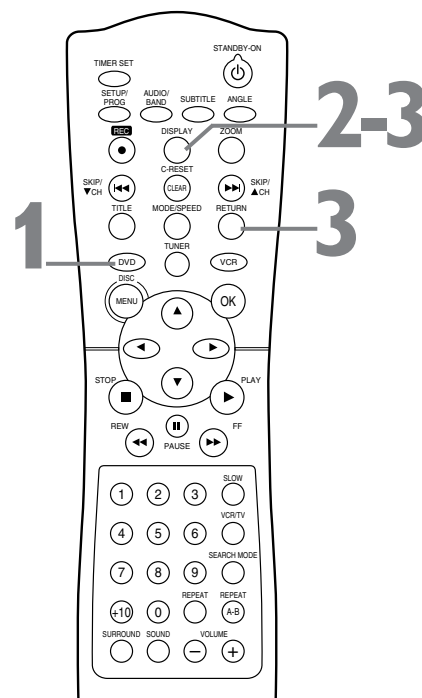

74 Black Level

Black Level

Adjust Black Level to brighten the DVD picture during playback.

- 1 Press **DVD** to ensure the System and the remote are in DVD mode. The red DVD light will appear on the front of the System.
- 2 During DVD playback, press **MODE/SPEED** so the Black Level icon shows in the top left corner of the TV screen.
- 3 Within 10 seconds, press **OK** repeatedly to choose **ON** or **OFF**. ON brightens the dark parts of the picture. OFF shows the original picture as recorded.

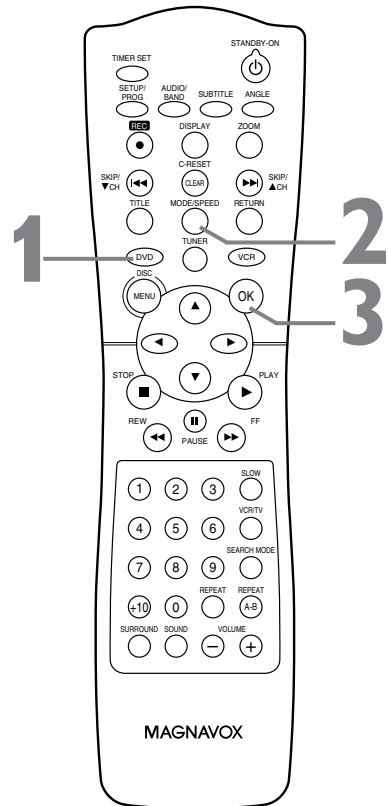

Selecting Radio Stations 75

- 1 Press TUNER to select Tuner mode.** The red TUNER light will appear on the front of the System. The current radio frequency (station number) will appear on the display panel.

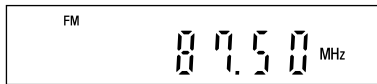

- 2 Press AUDIO/BAND to select FM or AM.**

- 3 Press ◀ or ▶ to select a preset radio station.** You also can select a preset radio station by pressing the Number buttons. The preset number will appear in the display panel to the left of the station's frequency. When choosing preset stations 10 and above, enter both digits within two seconds to ensure you enter the complete number. To set up preset radio stations, see page 76.

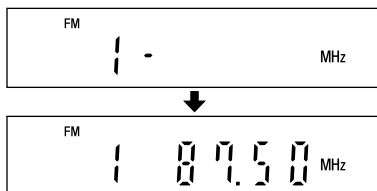

- 4 Press SKIP ▶▶/CH ▲ or SKIP ◀◀/CH ▼ to change the radio frequency by one-tenth.** For example, to go from 100.1 to 100.2, press SKIP ▶▶/CH ▲. Use these buttons to fine-tune the station you want.

Or, to search for the next available station, press and hold SKIP ▶▶/CH ▲ or SKIP ◀◀/CH ▼ for one second, then release. SEARCH will appear on the display panel when you release the button. When a station with sufficient signal strength is found, the station will be tuned and searching will stop. You can press and hold SKIP ◀◀/CH ▼ to search backward to the last available station.

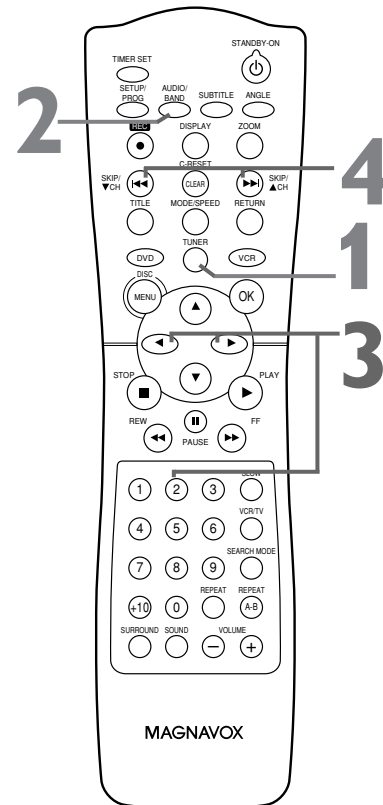
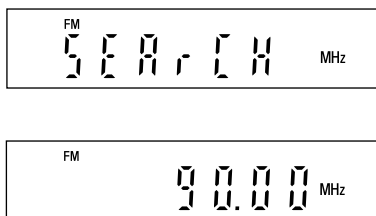

Helpful Hints

- You cannot use the VCR when the System is in Tuner mode. If you fast forward, rewind, or eject a videotape, you may hear noise through the speakers or some displays may be incorrect.
- You cannot use the Tuner when the System is in VCR mode. Make sure you stop tape play before putting the System in Tuner mode.
- If the sound is distorted during AM reception, press VCR/TV on the remote to reduce the noise. This is effective only for the current AM station. This does not work for every situation. There may be interference from other electrical appliances or weak AM signals.

76 Preset Radio Stations

Automatic Presetting

You can store up to 40 preset radio stations automatically by following these steps.

- 1 Press **TUNER** to select **Tuner mode**. The red **TUNER** light will appear on the front of the System.
- 2 Press and hold **SETUP/PROG** until **AUTO** appears on the System's display panel, then release **SETUP/PROG**. The System will start scanning for stations. FM stations will be set first, followed by AM stations. The System will store the first 40 stations found. When programming is finished, the last preset station will be tuned.

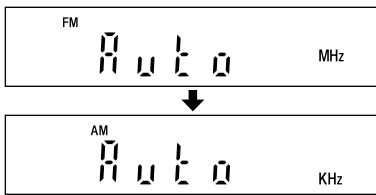

- 3 Or, you can press **SETUP/PROG** or **STOP** to stop presetting stations. The radio stations scanned so far will be stored. The last stored station will be tuned.

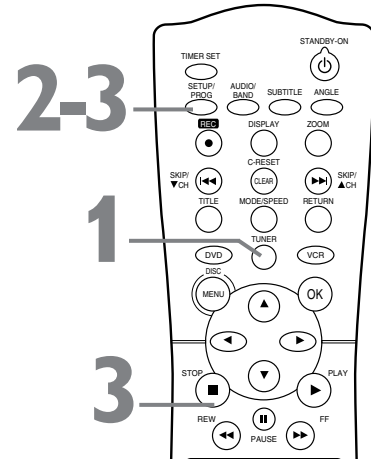

Manual Presetting

If Automatic Presetting does not memorize all the stations you want, you can preset individual stations manually.

- 1 Press **SKIP** **▶▶/CH ▲** or **SKIP** **◀◀/CH ▼** to select the station you want to designate as a preset station.

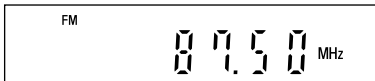

- 2 Press **SETUP/PROG**. The next available preset number and the station's frequency will blink in the display panel. To store the station under a different preset number, press **◀** or **▶** to choose a preset number. If Prog ... FULL appears before the station's frequency starts blinking, there are already 40 presets. Press **◀** or **▶** to choose a preset that you want to replace with the new station you are presetting now.

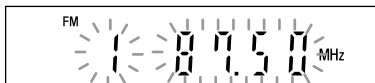

- 3 Within 20 seconds, press **SETUP/PROG** to store the radio station under the designated preset number. (After 20 seconds, the Tuner will exit presetting mode. If you've made a mistake, wait 20 seconds for the frequency and preset number to stop flashing, then try again.)

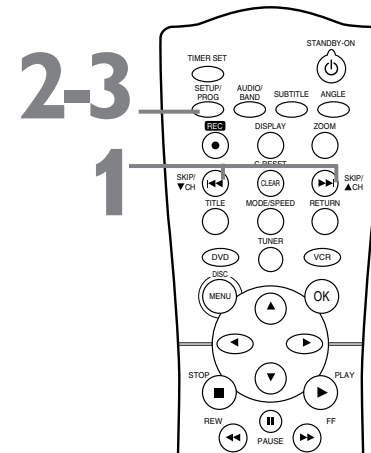
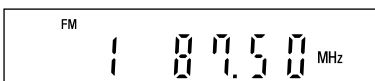

Helpful Hints

- If a radio station has been stored in one of the presets, it will not be stored again under another preset number during Automatic Presetting.
- To erase a preset, press **▶** or **◀** to select the preset station you want to delete. Then, press and hold **STOP** on the remote until **PRESET ... DELETED** appears on the System's display panel. The preset numbers of all other radio stations with higher numbers will decrease by one.

Glossary, Specifications 77

Glossary

AUDIO IN/OUT Jacks: jacks that receive audio from another source (IN) or send audio to another system (OUT). These jacks are red (right) and white (left).

Automatic Channel Setup: process in which the VCR memorizes TV channels. When you press SKIP ►►/CH ▲ or SKIP ◀◀/CH ▼ in VCR mode, you only scan through TV channels you receive.

Cable Box/DBS Output Channel: 03 or 04.

DIGITAL AUDIO OUT COAXIAL jack: Sends digital audio to a Stereo, letting you adjust the volume at the Stereo. This jack is black.

COMPONENT VIDEO OUT (Y, Pb/Cb, Pr/Cr) Jacks: jacks that send high-quality DVD video to a TV with Component Video In jacks. This provides the best picture quality for the DVD Player of the System. It does not provide a picture from the VCR of the System.

Dolby® Digital: A surround sound system that provides 5.1 channel sound as used in movie theaters.

DTS: Digital Theater Systems. This is a surround sound system, but it is different from Dolby® Digital. The formats were developed by different companies.

HQ: high quality; a feature in the VCR circuitry which provides enhanced picture detail.

Line Input: The channel to which you set your System during video cassette copying. If you connected the other video equipment to the AUDIO and VIDEO In jacks on the front of the System, select L2. If you used the AUDIO and VIDEO IN jacks on the back of the System, select L1. If you accidentally enter Line Input mode, press SKIP ►►/CH ▲ or SKIP ◀◀/CH ▼ or the Number buttons to select another channel.

S-Video: Produces a clearer DVD picture by sending separate signals for the luminance and the color. S-Video only provides a picture for the DVD Player of the System.

Tape Speeds: how fast the videotape travels during a recording or playback. The faster the tape speed, the better the picture quality. Slower tape speeds affect picture quality, but you record more onto a videotape.

- **SP** (standard play) – fastest tape speed (recording time for a T120 tape is approximately two hours); best picture quality.
- **LP** (long play) – average tape speed. You cannot record in LP with this VCR. If tapes were recorded on a different VCR in LP speed, the tape will play in LP in the VCR of this System.
- **SLP** (super long play) – slowest tape speed (recording time for a T120 tape is approximately six hours). This speed allows the maximum recording on a single videotape.

VIDEO IN/OUT Jacks: jacks that receive video from another source (IN) or send video to other video equipment or a TV (OUT). These jacks are yellow.

Specifications

VCR Video Heads

Four heads - Hi-Fi

Antenna

VHF/UHF - 75 ohm external antenna terminal

VHF Output Signal

Channel 03 or 04
75 ohms unbalanced

DVD Color System

NTSC

Amplifier

Output power (rms, 4 ohms, 1 kHz,
10% Total Harmonic Distortion)
300W total
- Front 50W/channel
- Center 50W
- Rear (Surround) 50W/channel
- Subwoofer 50W

FTC (Federal Trade Commission)
(4 ohms, 120 Hz to 12.5 kHz,
10 % Total Harmonic Distortion)
2 X 40W

Frequency Response

DVD (linear sound):
20 Hz to 22 kHz
(sample rate: 48 kHz)
20 Hz to 44 kHz (surround off)
(sample rate: 96 kHz)
Audio CD: 20 Hz to 20 kHz

Signal-to-Noise Ratio

Audio CD: 90 dB JEITIA
(Japan Electronics and Information
Technology Industries Association)

Dynamic Range

DVD (linear sound): 90 dB
Audio CD: 90 dB (JEITIA)

Total Distortion Factor

Audio CD: 0.01% (JEITIA)
DVD: 0.01%

Wow and Flutter

Below the measurement limitation
(±0.001% W PEAK) (JEITIA)

Power Requirement

120V AC +/- 10%, 60 Hz +/- 0.5%

Power Consumption

Power on: 120 W
Power off (standby): 7.6 W

Operating Temperature

41°F (5°C) to 104°F (40°C)

Relative Humidity

30% to 80%

Dimensions (w x h x d)

Receiver (System):
17" x 3.9" x 14.2"
43.5 x 9.9 x 36.2 cm

Front Speakers:
3.7" x 6.1" x 3.5"
9.4 x 15.5 x 8.8 cm

Rear Speakers:
3.7" x 6.1" x 3.5"
9.4 x 15.5 x 8.8 cm

Center Speaker:
9.8" x 3.7" x 3.5"
25 x 9.4 x 8.8 cm

Subwoofer:
7.9" x 12" x 13.6"
20 x 30.5 x 34.5 cm

Weight

16.1 lbs. (7.3 kg.)

NOTE: Designs and specifications are subject to change without notice.

78 Helpful Hints

Cleaning the System

- Wipe the front panel and other exterior surfaces of the System with a soft, slightly damp cloth.
- Never use a solvent, thinner, benzene, or alcohol to clean the System. Do not spray insecticide liquid near the System. Such chemicals may discolor the surface or damage the System.

Cleaning a Disc

- Use a soft, dry cloth to wipe the Disc.
- Wipe the Disc in a straight line from the center to the edge. Never wipe the Disc in a circular motion.
- Do not use detergent or abrasive cleaning agents.
- Handle the Discs so fingerprints and dust do not adhere to the Discs.
- Always store the Disc in its protective case when it is not in use.

Checking the Laser

- If the System does not operate as described in this manual, the DVD Player's laser may be dirty. Consult an Authorized Service Center for inspection and cleaning of the laser.

Caring for Video Cassettes

- Use only cassettes with the **VHS** mark.
- Remove any light adhesive stick-on notes from the video cassette before putting the cassette in the VCR. Removable labels can jam the VCR.

The System has no power.

- Make sure the power cord is connected completely to an AC (alternating current) outlet.
- Press the STANDBY-ON  button to turn on the System. The System turns on in the mode it was in when you turned it off. If the power fails for more than one minute, it will turn on in VCR mode.

The remote control will not operate the System.

- Aim the remote control directly at the remote sensor (IR) on the front of the System, not toward the TV. *Details are on page 24.*
- Remove all obstacles between the remote control and the System.
- Inspect and/or replace the batteries in the remote control. *Details are on page 18.*
- Use the remote control within 23 feet of the System.
- When using the DVD Player, press the DVD button, then try the other DVD feature buttons. The red DVD light appears on the front of the System when it is in DVD mode.
- To use the VCR, press VCR, then try the other VCR feature buttons. The red VCR light appears on the front of the System when it is in VCR mode.
- To use the Tuner, press TUNER, then try the other Tuner feature buttons. The red TUNER light appears on the front of the System when it is in Tuner mode.

There is no picture in DVD mode.

- Make sure the video cable is connected correctly. You may connect either the yellow video cable (supplied), an optional S-Video cable, or optional component video cables. Make sure the TV is set to the correct Video In channel (usually the AUX IN, A/V IN, Auxiliary In, EXT or External In, Component Video In, or S-Video In channel). Check your TV owner's manual for details. *Details are on pages 11-15.*
- If you only used the supplied black RF coaxial cable, make sure the TV is set to channel 3 or 4 (the output channel of the System). *(To change the System's output channel, see page eight.)* Or, if you have a Cable Box/Satellite Receiver, make sure the TV is set to the Cable Box/Satellite Receiver output channel (usually 03 or 04). *Details are on pages 8-10.*
- Insert a DVD that is playable on this System. *Details are on page six.*
- Put the System in DVD mode. Press DVD on the remote or SOURCE on the front of the System so the red DVD light appears on the front of the System.

Disc cannot play.

- Insert a playable Disc. *Details are on page six.*
- Place the Disc correctly in the Disc tray. If the Disc is one-sided, place the Disc in the tray with the label facing up. If the Disc is two-sided, make sure the label of the side you want to play is facing up.
- Clean the Disc. Make sure the Disc is not scratched or warped.
- Cancel the Parental Controls, enter the password, or change the control level. *Details are on pages 64-65.*
- Make sure the Disc is labelled for use in Region 1 or ALL regions and is NTSC compatible. *Details are on page six.*

Helpful Hints (cont'd) 79

There is no sound or sound is poor.

- Connect the audio cables firmly. Make sure the cables are connected to the AUDIO IN jacks on the TV or Stereo. *Details are on pages 11-14.*
- Check the audio settings of the DVD Player. *Details are on page 72.*
- Check the audio settings of the DVD. For example, you may have selected "soundtrack" playback or an unavailable sound setting (such as Dolby Digital). *Details are on pages 66 and 72.* Try other sound options provided in the DVD Disc menu.
- If you used audio cables (instead of only using the supplied black RF coaxial cable) make sure the TV or Stereo is set to the correct Audio In channel (usually the AUX IN, Auxiliary In, A/V IN, Audio In, or External In channel). See your TV or Stereo owner's manual for details.
- Adjust the volume or disconnect the headphones.
- Make sure the speakers are connected correctly to the System. *Details are on page 17.*

The picture is distorted.

- Connect the System directly to the TV. *Details are on pages 8-15.* Do not connect the System to a VCR, then connect the VCR to the TV. Copyright protection systems in the VCR could distort the picture playing on the System.
- A Disc or videotape picture may be distorted because of the quality in which it was recorded. This is not a malfunction of the System.
- Make sure the Disc is compatible with the DVD Player of the System. *Details are on page six.*

You cannot change the camera angle of a DVD.

- The DVD might not contain segments recorded from different camera angles. See if multiple angles are available by referring to the Disc case or DVD Disc menu. *Details are on page 61.*

You cannot change the audio or subtitle language of a DVD.

- The DVD does not contain audio or subtitles in the desired language. Not all DVDs contain audio or subtitles in multiple languages. See if other languages are available by referring to the Disc case or DVD Disc menu. *Details are on pages 61 and 66.*

An X appears in the top right corner of the TV screen when you try a DVD feature.

- The operation is not available at the current time or the feature is not available on the Disc. Some features are only available during playback. Others can be accessed only if play is stopped. Try stopping or playing the Disc, then try the feature again.

The System switches from DVD mode to VCR mode after 35 minutes of no activity.

- When AUTO POWER OFF is set to ON, the System switches itself from DVD mode to VCR mode if Disc playback stops for more than 35 minutes and you press no buttons on the remote or the System. *Details are on page 69.*

A screen saver appears on the TV screen during DVD mode.

- The DVD logo will appear on the TV screen when you stop Disc playback. You cannot remove it.

You want to use the DVD Player during a VCR timer recording or while the TIMER REC light appears.

- Press STANDBY-ON  to turn on the System. Press DVD to choose DVD mode, then continue with other DVD features as described in this manual.

Radio reception is poor.

- If the signal is too weak, adjust the antenna or connect an external antenna for better reception.
- Increase the distance between the System and your other electronics equipment.

80 Helpful Hints (cont'd)

Power Failure

- VCR timer recordings, clock setting, language selection, and channel setup may be lost if the power fails. See pages 28-32 to set up the channels, clock, and language again. See pages 38-40 to reprogram your timer recordings.

The VCR will not record a TV program.

- Put the System in VCR mode. Press VCR or SOURCE so the red VCR light appears on the front of the System.
- Check the connections between the System, TV, antenna/Cable TV signal, and Cable Box/Satellite Receiver (if applicable). *Details are on pages 8-15.* For VCR features, you must connect the System to a TV with the RF coaxial cable or the yellow video cable as described on pages eight and 11.
- Make sure the video cassette has a record tab. *Details are on page 34.*

The VCR will not perform a timer recording.

- Make sure the recording start and stop times are set correctly. *Details are on pages 38-40.*
- Make sure a tape is in the VCR and the tape has a record tab. *Details are on page 34.* If, after programming a timer recording, you press TIMER SET without putting a tape in the System, the TIMER REC light will blink.
- If the record tab on a tape is missing, the System will eject the tape. The TIMER REC light will blink.
- Press TIMER SET to put the System in standby mode for the timer recording. The TIMER REC light should appear on the front of the System.
- Make sure the VCR clock is set. *Details are on pages 30-31.*
- The VCR may not perform or continue a timer recording if the power fails.
- If you have a Cable Box/Satellite Receiver, set timer recordings differently. *Details are on page nine.*
- Finish programming a timer recording at least five minutes before it is set to begin.
- 12 p.m. is noon; 12 a.m. is midnight.

There is no picture or the picture is noisy or has streaks during video cassette playback.

- Put the System in VCR mode. Press VCR or SOURCE so the red VCR light appears on the front of the System.
- If you used the supplied RF coaxial cable to connect the System to the TV, make sure the TV is on the same channel as the System's output channel (03 or 04). The System's output channel is channel 3 when you receive it. To change it to channel 4, see page eight. Make sure channel 03 or 04 is properly adjusted at the TV.
Or, if you connected the System to the TV using audio and video cables, select the correct Video In channel at the TV. *Details are on page 11.*
You must use either the RF coaxial cable or the yellow video cable to get a VCR picture. The S-Video and Component Video connections will not supply a VCR picture.
- Adjust the tracking. *Details are on page 46.*
- TVs placed too close to the System can cause interference during tape playback. Move the System away from the TV.

The Number buttons won't work for TV channels above 69.

- Enter channel numbers as a two-digit number. If you want to select channels 100 and above, enter channel numbers as a three-digit number. If you do not have Cable TV, only channels 2-69 are possible.

TV programs cannot be watched normally.

- Check the connections between the System, TV, antenna/Cable TV signal, and Cable Box/Satellite Receiver (if applicable). *Details are on pages 8-15.*

Poor reception

- You may need to tune your TV again. Or, reset channels at the VCR using CHANNEL SET UP. *Details are on pages 28-29.*

Helpful Hints (cont'd) 81

You cannot insert a video cassette.

- Insert the tape, window side up, with the record tab facing you.
- Make sure a tape isn't already in the VCR by pressing STOP/EJECT ■▲ on the front of the System.
- Gently push on the center of the tape when putting it in the VCR. Never force the tape into the VCR.
- If a timer recording is set, you cannot insert a tape without a record tab.

You cannot remove the tape.

- Make sure the power plug is completely connected to a power outlet.
- Unplug the System power cord for five minutes. Then, plug in the power cord again and press STANDBY-ON ⓪ on the System. Press STOP/EJECT ■▲ on the System three to five times. If the tape still does not eject, you may need to have an authorized servicer remove the tape.

The System ejects the tape when you press REC ●, RECORD ●, or TIMER SET.

- Make sure the tape has a record tab. *Details are on page 34.*

Line Input mode

- If you accidentally enter Line Input mode (L1 or L2 will appear on your TV screen briefly), press SKIP ►►/CH ▲ or SKIP ◄◄/CH ▼ or the Number buttons to select another channel.

Hi-Fi Stereo Sound

- During playback, Hi-Fi audio may normally revert to normal audio when you adjust tracking.
- When connecting the System to a TV with the red and white audio cables, you will only get stereo sound if you connect the AUDIO (DVD/VCR OUT) jacks on the System to the Audio In jacks on your TV. Put the TV on its Audio/Video In channel. See your TV owner's manual for details.
- When you connect the AUDIO (DVD/VCR OUT) jacks on the System to the Audio In jacks on your TV, the stereo light on the TV might not glow. If the status display indicates you are receiving stereo, you are. *Details are on page 47.*
- Only tapes recorded in Hi-Fi audio will play in Hi-Fi audio. Tapes recorded in normal audio will play in monaural (single-channel) audio.

Cleaning the Video Heads

- Your System automatically cleans the video heads of the VCR each time you insert a tape. However, the heads may become dirty. If so, have an authorized servicer clean the video heads. Eventually, the heads may need to be replaced.

The playback picture is too dim, too bright, or fluctuates in brightness.

- Some programs may be broadcast with copyright protection technology in order to protect the rights of copyright owners. This technology is used on programs that are recorded on video cassettes or DVDs, as well as some programs broadcast by antenna/cable/satellite television channels. Programs broadcast with copyright protection may not record clearly. Likewise, if you play a tape that is a recording of a copyright protected program, the picture may not be clear. Tapes of copyright protected programs may have a picture that is dark or dim, or the brightness of the picture may fluctuate. Therefore, avoid recording or playing copies of copyright protected programs.
- This System incorporates copyright protection technology that is protected by method claims of certain U.S. patents and other intellectual property rights owned by Macrovision Corporation and other rights owners. Use of this copyright protection technology must be authorized by Macrovision Corporation and is intended for home and other limited viewing uses only, unless otherwise authorized by Macrovision Corporation. Reverse engineering or disassembly is prohibited.

82 Limited Warranty

MAGNAVOX AUDIO SYSTEM

One Year Free Exchange

This product must be carried in for an exchange.

WHO IS COVERED?

You must have proof of purchase to exchange the product. A sales receipt or other document showing that you purchased the product is considered proof of purchase. Attach it to this owner's manual and keep both nearby.

WHAT IS COVERED?

Warranty coverage begins the day you buy your product. For one year thereafter, a defective or inoperative product will be replaced with a new, renewed, or comparable product at no charge to you. A replacement product is covered only for the original warranty period. When the warranty on the original product expires, the warranty on the replacement product also expires.

WHAT IS EXCLUDED?

Your warranty does not cover:

- labor charges for installation or setup of the product, adjustment of customer controls on the product, and installation or repair of antenna systems outside of the product.
- product repair and/or part replacement because of misuse, accident, unauthorized repair or other cause not within the control of Magnavox.
- reception problems caused by signal conditions or cable or antenna systems outside the unit.
- a product that requires modification or adaptation to enable it to operate in any country other than the country for which it was designed, manufactured, approved and/or authorized, or repair of products damaged by these modifications.
- incidental or consequential damages resulting from the product. (Some states do not allow the exclusion of incidental or consequential damages, so the above exclusion may not apply to you. This includes, but is not limited to, prerecorded material, whether copyrighted or not copyrighted.)
- a product that is used for commercial or institutional purposes.

WHERE IS EXCHANGE AVAILABLE?

You may exchange the product in all countries where the product is officially distributed by Magnavox. In countries where Magnavox does not distribute the product, the local Magnavox service organization will attempt to provide a replacement product (although there may be a delay if the appropriate product is not readily available).

BEFORE REQUESTING EXCHANGE...

Please check your owner's manual before requesting an exchange. Adjustments of the controls discussed there may save you a trip.

EXCHANGING A PRODUCT IN U.S.A., PUERTO RICO, OR U.S. VIRGIN ISLANDS...

Contact Magnavox to arrange an exchange. Please call 1-800-705-2000 to arrange an exchange. (In U.S.A., Puerto Rico, and U.S. Virgin Islands, all implied warranties, including implied warranties of merchantability and fitness for a particular purpose, are limited in duration to the duration of this express warranty. But, because some states do not allow limitations on how long an implied warranty may last, this limitation may not apply to you.)

EXCHANGING A PRODUCT IN CANADA...

Please contact Magnavox at:

1-800-661-6162 (French Speaking)

1-800-705-2000 (English or Spanish Speaking)

(In Canada, this warranty is given in lieu of all other warranties. No other warranties are expressed or implied, including any implied warranties of merchantability or fitness for a particular purpose. Magnavox is not liable under any circumstances for any direct, indirect, special, incidental or consequential damages, howsoever incurred, even if notified of the possibility of such damages.)

REMEMBER...

Please record below the model and serial numbers found on the product. Also, please fill out and mail your warranty registration card promptly. It will be easier for us to notify you if necessary.

MODEL # _____
SERIAL # _____

This warranty gives you specific legal rights. You may have other rights which vary from state/province to state/province.

Magnavox, P.O. Box 520890, Miami, FL 33152 (402) 536-4171

EL6519E002 / 5-03

84 Information Index

- a-b repeat 59
a-b repeat button 22, 59
ac power cord 27
am/fm 75
angle button 22, 61
angle icon 69
antenna connections (am/fm) 16
arrow buttons 22
audio/band button 22, 66, 75
audio jacks 11-14, 25, 27, 37
audio language (dvd) 66
audio settings 72
auto power off 69
auto repeat 42
automatic tape playback 46
automatic tape rewind, eject 46
- batteries 18
bit-rate display 73
black bars 69
black level 74
- c-reset/clear button 22, 43
camera angle 61
cassette compartment 25
channel
 adding 29
 deleting 29
 selection 23
 setup 19, 28
chapters 56
clock 30-31
component video out jacks 12, 27
connections 7-17
contents, table of 4
controls
 remote 22-23
 system 24-27
copyright protection 37, 41, 81
counter (videotape) 33, 43
- delay time 50-51
digital audio out coaxial jack 15, 27
digital sound 49
disc menus 54, 70-71
disc tray 24
disc/menu button 23, 54
display button 22, 33, 68, 73
display panel 26
display panel messages 26
displays 33, 73
dolby digital 72
down sampling 72
drc (dynamic range control) 72
duplication (dvd to videotape) 41
duplication (tape) 37
dvd button 22
dvd light 24
- ejecting a tape 20, 25, 46
- fast forward 45, 55
ff ►► (fast forward) button 23
front panel 24-25
glossary 77
- head cleaner 81
helpful hints 78-81
hi-fi stereo sound 48
hookups
 antenna 16
 cable box/dbs 9-10
 component video 12
 s-video 13
 speakers 17
 stereo 14-15
 tv 8-15
 tv only (rf) 8
- index search 44
ir (infrared remote sensor) 24
- jpeg 67-68
- language (dvd) 70-71
language (vcr) 32
language codes 71
line input mode 37, 77
long play 77
lp 77
- markers 60
menus 5, 54
mode/speed button 23, 63
mp3 display 68
mp3 playback 67
- number buttons 23
- ok button 22
on-screen status displays (vcr) 33
one-touch recording 36
open/close ▲ button 21, 24
- parental controls 64-65
password 64
pause ■■ button 22, 45, 58, 62
picture cds 6, 67-68
play ► buttons 20-22, 24, 25, 45
player menu 70-71
playing discs 21
playing tapes 20
power cord 27
preset radio stations 76
program 63
- quick setup 69, 70, 72
- radio stations 75
random 63
rear panel 27
rec ● (record) button 23, 34
record ● button 25, 36
record light 25
recording
 basic 34
 one channel/watching another 35
 prevention 34
 timer 38-40
repeat button 22, 59
repeat (discs) 59
repeat (tape) 42
- rerecording 37
resume 58
return button 23
reverse searching 45, 55
rew ◀◀ (rewind) button 22, 45, 55
rf coaxial cable 8-10
- safety precautions 3
sap (second audio program) 47
search mode button 22, 44, 56-57
searching 45, 55
sensor (remote) 24
setup/prog button 22, 76
skip ►►/ch▲,
skip ◀◀/ch▼ buttons 23, 57, 75
slow button 22, 45
slow motion 45, 62
slp 77
source button 24
sp 77
speaker balance 52-53
speaker connections 17
specifications 77
standard play 77
status displays 33, 73
step-by-step playback 58
stereo (receiving/recording) 47
stereo sound 66
still picture 45, 58
stop ■ buttons 23-24
stop/eject ▲ button 25
subtitle button 22, 61
subwoofer 17
super high speed searching 45
super long play 77
surround sound 17, 49
s-video out jack 13, 27
- table of contents 4
tape speed 34, 77
time search 44
timer rec light 25, 36, 40
timer recording
 cancelling 40
 setting 38-40
timer set button 23, 40
title button 22, 54
titles 54
tracking 46
tracks 57
tuner 75-76
tv antenna in/out jacks 8-15, 27
tv aspect 69
tv hookups 7-15
- vcr button 23
vcr light 24
vcr/tv button 23
video in/out jacks 11, 14-15, 25, 27, 37
- warranty 82
- zoom 62
zoom button 22, 62



This owner's manual is made of recyclable materials. Remember to recycle!
IB8437E002 Printed In China
0VMN03700/E9000UD ***

Free Manuals Download Website

<http://myh66.com>

<http://usermanuals.us>

<http://www.somanuals.com>

<http://www.4manuals.cc>

<http://www.manual-lib.com>

<http://www.404manual.com>

<http://www.luxmanual.com>

<http://aubethermostatmanual.com>

Golf course search by state

<http://golfingnear.com>

Email search by domain

<http://emailbydomain.com>

Auto manuals search

<http://auto.somanuals.com>

TV manuals search

<http://tv.somanuals.com>