

Owner`s Manual

15MF/20MF Series
LCD TV

MAGNAVOX
SMART. VERY SMART.



NEED HELP? CALL US!

MAGNAVOX REPRESENTATIVES ARE READY TO HELP YOU WITH ANY QUESTIONS ABOUT YOUR NEW PRODUCT. WE CAN GUIDE YOU THROUGH CONNECTIONS, FIRST-TIME SETUP, AND ANY OF THE FEATURES. WE WANT YOU TO START ENJOYING YOUR NEW PRODUCT RIGHT AWAY.

CALL US BEFORE YOU CONSIDER RETURNING THE PRODUCT.

1-800-705-2000

OR VISIT US ON THE WEB AT WWW.MAGNAVOX.COM

Important!

Return your Warranty Registration Card within 10 days.

RETURN YOUR PRODUCT REGISTRATION CARD TODAY
TO GET THE VERY MOST FROM YOUR PURCHASE.

Registering your model with MAGNAVOX makes you eligible for all of the valuable benefits listed below, so don't miss out. Complete and return your Product Registration Card at once to ensure:

*Proof of Purchase

Returning the enclosed card guarantees that your date of purchase will be on file, so no additional paperwork will be required from you to obtain warranty service.

*Product Safety Notification

By registering your product, you'll receive notification - directly from the manufacturer - in the rare case of a product recall or safety defect.

*Additional Benefits of Product Ownership

Registering your product guarantees that you'll receive all of the privileges to which you're entitled, including special money-saving offers.

MAGNAVOX

Congratulations on your purchase, and welcome to the "family!"

Dear MAGNAVOX product owner:

Thank you for your confidence in MAGNAVOX. You've selected one of the best-built, best-backed products available today. We'll do everything in our power to keep you happy with your purchase for many years to come.

As a member of the MAGNAVOX "family," you're entitled to protection by one of the most comprehensive warranties and outstanding service networks in the industry. What's more, your purchase guarantees you'll receive all the information and special offers for which you qualify, plus easy access to accessories from our convenient home shopping network.

Most importantly, you can count on our uncompromising commitment to your total satisfaction.

All of this is our way of saying welcome - and thanks for investing in a MAGNAVOX product.

P.S. To get the most from your MAGNAVOX purchase, you must return your Warranty Registration Card within 10 days. So please mail it to us right now!

Know these **safety** symbols



This "bolt of lightning" indicates uninsulated material within your unit may cause an electrical shock. For the safety of everyone in your household, please do not remove product covering.



The "exclamation point" calls attention to features for which you should read the enclosed literature closely to prevent operating and maintenance problems.

WARNING: To reduce the risk of fire or electric shock, this apparatus should not be exposed to rain or moisture and objects filled with liquids, such as vases, should not be placed on this apparatus.

CAUTION: To prevent electric shock, match wide blade of plug to wide slot, fully insert.

ATTENTION: Pour éviter les choc électriques, introduire la lame la plus large de la fiche dans la borne correspondante de la prise et pousser jusqu'au fond.

For Customer Use

Enter below the Serial No. which is located on the rear of the cabinet. Retain this information for future reference.

Model No. _____
Serial No. _____

IMPORTANT SAFETY INSTRUCTIONS

READ BEFORE OPERATING EQUIPMENT

- Read these instructions.
- Keep these instructions.
- Heed all warnings.
- Follow all instructions.
- Do not use this apparatus near water.
- Clean only with a dry cloth.
- Do not block any of the ventilation openings. Install in accordance with the manufacturer's instructions.
- Do not install near any heat sources such as radiators, heat registers, stoves, or other apparatus (including amplifiers) that produce heat.
- Do not defeat the safety purpose of the polarized or grounding-type plug. A polarized plug has two blades with one wider than the other. A grounding type plug has two blades and third grounding prong. The wide blade or third prong are provided for your safety. When the provided plug does not fit into your outlet, consult an electrician for replacement of the obsolete outlet.
- Protect the power cord from being walked on or pinched particularly at plugs, convenience receptacles, and the point where they exit from the apparatus.
- Only use attachments/accessories specified by the manufacturer.
-  Use only with a cart, stand, tripod, bracket, or table specified by the manufacturer, or sold with the apparatus. When a cart is used, use caution when moving the cart/apparatus combination to avoid injury from tip-over.
- Unplug this apparatus during lightning storms or when unused for long periods of time.
- Refer all servicing to qualified service personnel. Servicing is required when the apparatus has been damaged in any way, such as power-supply cord or plug is damaged, liquid has been spilled or objects have fallen into apparatus, the apparatus has been exposed to rain or moisture, does not operate normally, or has been dropped.
- This product may contain lead and mercury. Disposal of these materials may be regulated due to environmental considerations. For disposal or recycling information, please contact your local authorities or the Electronic Industries Alliance: www.eiae.org
- Damage Requiring Service** - The appliance should be serviced by qualified service personnel when:
 - The power supply cord or the plug has been damaged;
 - Objects have fallen, or liquid has been spilled into the appliance;
 - The appliance has been exposed to rain
 - The appliance does not appear to operate normally or exhibits a marked change in performance;
- The appliance has been dropped, or the enclosure damaged.
- Tilt/Stability** - All televisions must comply with recommended international global safety standards for tilt and stability properties of its cabinet design.
 - Do not compromise these design standards by applying excessive pull force to the front, or top, of the cabinet which could ultimately overturn the product.
 - Also, do not endanger yourself, or children, by placing electronic equipment/toys on the top of the cabinet. Such items could unsuspectingly fall from the top of the set and cause product damage and/or personal injury.
- Wall or Ceiling Mounting** - The appliance should be mounted to a wall or ceiling only as recommended by the manufacturer.
- Power Lines** - An outdoor antenna should be located away from power lines.
- Outdoor Antenna Grounding** - If an outside antenna is connected to the receiver, be sure the antenna system is grounded so as to provide some protection against voltage surges and built up static charges. Section 810 of the National Electric Code, ANSI/NFPA No. 70-1984, provides information with respect to proper grounding of the mast and supporting structure, grounding of the lead-in wire to an antenna discharge unit, size of grounding connectors, location of antenna-discharge unit, connection to grounding electrodes, and requirements for the grounding electrode. See Figure below.
- Object and Liquid Entry** - Care should be taken so that objects do not fall and liquids are not spilled into the enclosure through openings.
- Battery Usage CAUTION** - To prevent battery leakage that may result in bodily injury, property damage, or damage to the unit:
 - Install all batteries correctly, with + and - aligned as marked on the unit.
 - Do not mix batteries (old and new or carbon and alkaline, etc.).
 - Remove batteries when the unit is not used for a long time.

Note to the CATV system installer: This reminder is provided to call the CATV system installer's attention to Article 820-40 of the NEC that provides guidelines for proper grounding and, in particular, specifies that the cable ground shall be connected to the grounding system of the building, as close to the point of cable entry as practical.

Example of Antenna Grounding as per NEC - National Electric Code

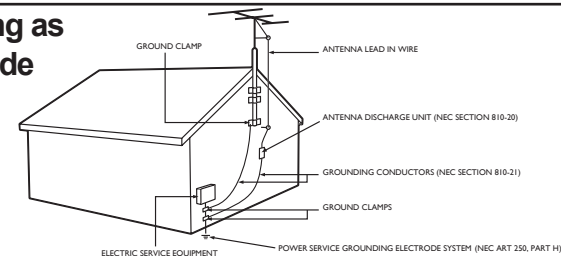

Introduction
 Welcome/Registration of Your TV2
 IMPORTANT SAFETY INSTRUCTIONS3
 Table of Content4

Getting Started
 Before Installation5
 Installing LCD TV on the wall5
 Basic TV and Remote Control Operations6
 Remote Control7
 Antenna Connection8
 Basic Cable TV Connection8
 Cable Box Connections9
 Audio/Video Input Connections10
 S-Video Connections11
 Component (YPbPr) Connections12
 PC (Monitor) Connection13

Install Menu
 Language Settings14
 Tuner Mode Control15
 Auto Program (Setting Up Channels)16
 Channel Edit Control (To Add or Delete channels)17
 Factory Reset18

Smart Picture and Smart Sound
 Smart Picture Control19
 Smart Sound Control19

Picture Menu
 TV Picture Menu Controls20

Sound Menu
 TV Sound Menu Controls21

Features Menu
 Auto Lock22
 Auto Lock Access Code23
 Auto Lock Program24
 Auto Lock - Movie Ratings25
 Auto Lock - TV Ratings26
 Using The Picture Format27
 Closed Captions28

PC Mode
 PC Picture Controls29
 PC Audio Controls30
 Using PC PIP (Picture In Picture) Feature31
 Setting Up The PC Mode32

General Information
 Trouble Shooting Tips33
 Care And Cleaning34
 Index35
 Regulatory36
 Factory Service Locations37
 Factory Service Locations38
 Limited Warranty39

Here are a few of the special features of your new LCD TV.

Audio/Video In Jacks: Use to quickly connect other equipment to your LCD TV.

Automatic Channel Programming (Auto Program): Quick and easy setup of available channels.

Closed Captioning: Allows the viewer to read TV program dialog or voice conversations as on-screen text.

On-screen Menus: Helpful messages (in English, Spanish, or French) for setting TV controls.

Remote Control: Works your LCD TV features.

Sleep Timer: Turns off the LCD TV within an amount of time you specify (15-240 minutes from the current time).

AutoLock: Lets you block viewing of certain TV channels if you do not want your children viewing inappropriate material.

Standard broadcast (VHF/UHF) or Cable TV channel capability

Stereo capability: Includes a built-in amplifier and twin-speaker system, allowing reception of TV programs broadcast in stereo.

Treble, Bass, and Balance: Enhance the LCD TV's sound.

NOTE: This manual covers different versions and models. Not all features described in this manual will match those of your LCD TV. This is normal and does not require you contacting your dealer or requesting service.

END-OF-LIFE DISPOSAL

Your new LCD TV and its packaging contain materials that can be recycled and reused. Specialized companies can recycle your product to increase the amount of reusable materials and minimize the amounts that need to be properly disposed.

Your product also uses batteries that should not be thrown away when depleted, but should be handed in and disposed of as small chemical waste. When you replace your existing equipment, please find out about the local regulations regarding disposal of your old television, batteries, and packing materials.

Before proceed to install your new LCD TV, please follow the steps and diagrams as shown to familiarize yourself with the correct and safe way of unfolding the base.

- 1 Place the set facing down on a flat surface and a protective sheet.
- 2 Unfold the base following the direction as shown on the diagram.
- 3 Place the set upright, you LCD TV is now ready for install.

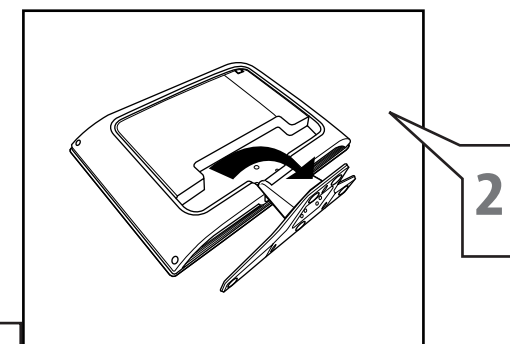
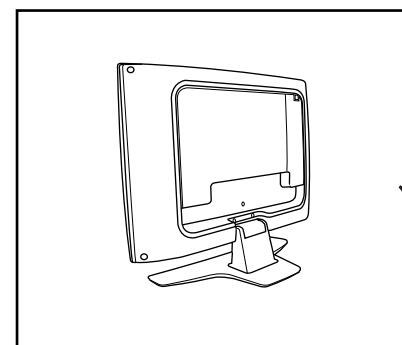
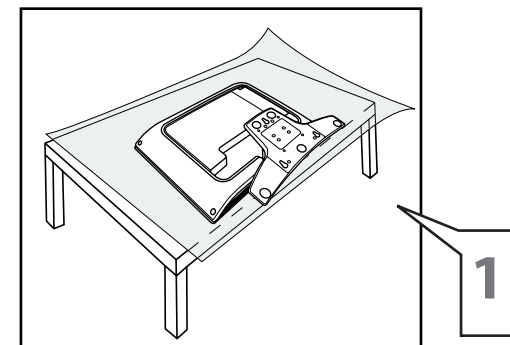

INSTALLING LCD TV ON THE WALL

The stand of your LCD TV is comply with Standard VESA 75 standard, if you intend to install the LCD TV on the wall, please consult a professional technician for proper installing.

The manufacture accepts no liability for installations not performed by professional technician.

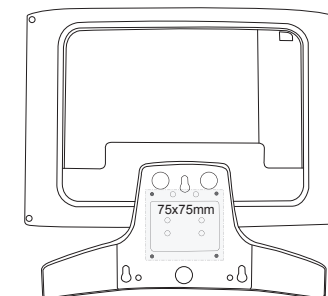
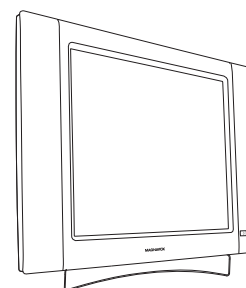

TELEVISION AND REMOTE CONTROL

- 1 Plug the DC adapter into the DC IN 16V jack on the LCD TV. Plug the power cable into an outlet.
- 2 Press POWER to turn on the LCD TV.
- 3 Press VOLUME + to increase the sound level. Or, press VOLUME- to lower the sound level.
- 4 Press CH+ or CH- to select channels.
- 5 Point the remote control toward on the front of the LCD TV when operating the LCD TV with the remote.

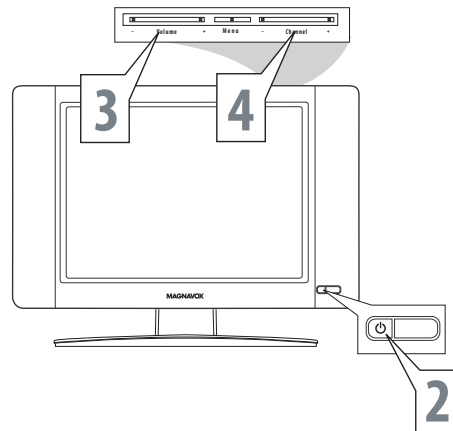

BATTERY INSTALLATION

- 6 Remove the battery compartment lid on the back of the remote.
- 7 Place two AAA batteries in the remote. Be sure the (+) and (-) ends of the batteries line up as marked inside the battery compartment.
- 8 Reattach the battery compartment lid.

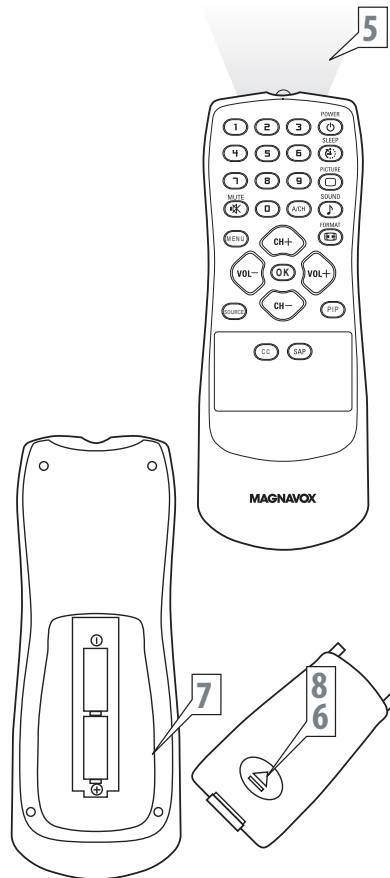

Number buttons

Press to select TV channels. When selecting single-digit channels, press the number of the desired channel. The LCD TV will pause for a few seconds then tune to the selected channel.

Mute button

Press to eliminate or restore the LCD TV sound. Mute will appear on the screen when the sound is muted.

Menu button

Press to activate onscreen menu, back to previous level inside the onscreen menu, also press to exit the onscreen menu.

Volume button

Press to increase or decrease the sound level, also press to navigate left/right in onscreen menu.

Source button

Press to select the video input source: AV, S-Video, HD, PC, TV.

OK button

Press to confirm the option you selected in the onscreen menu.

C.C button

Press the C.C button to select CC on or CC off.

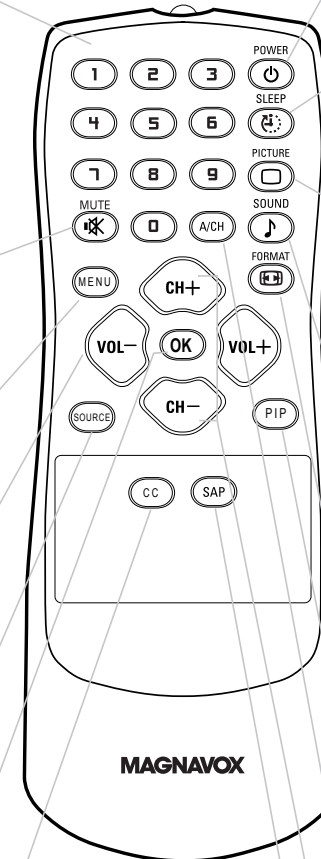

Standby (Power) button

Press to turn the LCD TV on or off.

Sleep button

Press to set the LCD TV to turn itself off within a certain time.

Smart Picture button

Press repeatedly to select either Personal, Movie, Sports, Weak signal, or Multimedia picture setting.

Smart Sound button

Press repeatedly to select among the 4 settings; Personal, News, Music, or Theater.

Picture Format button

Press the FORMAT button repeatedly to toggle among the four screen format sizes; 4:3, EXPAND 4:3, COMPRESS 16:9, or HD 4:3.

PIP button

Press repeatedly to change the size of PIP window in PC mode.

Previous Channel button

Press to go to previously selected channel.

Channel button

Press to adjust the channel up or down. Also press to select or navigate up/down in onscreen menu.

SAP button

Press to select a sound mode if available with the TV programming: Mono, Stereo, or SAP.

A combination antenna receives normal broadcast channels (VHF 2–13 and UHF 14–69). Your connection is easy because there is only one 75 Ω (ohm) antenna jack on the back of your TV, and that's where the antenna goes.

- 1 If your antenna has a round cable (75 ohm) on the end, then you're ready to connect it to the LCD TV. If your antenna has flat, twin-lead wire (300 ohm), you first need to attach the antenna wires to the screws on a 300- to 75-ohm adapter (not supplied).
- 2 Connect the antenna (or adapter) to one end of the supplied L-Adapter as shown, and connect the other end of the L-Adapter to the TV jack on the side of the LCD TV.

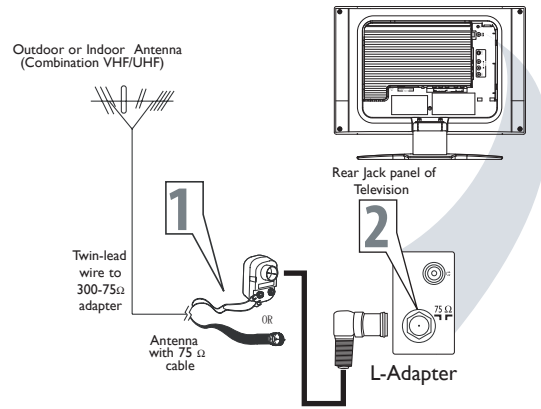

BASIC CABLE TV CONNECTION

Your Cable TV signal into your home may be a single, 75Ω (ohm) cable. If so, this connection is very simple. Follow the step below to connect your Cable TV signal to your new LCD TV.

- 1 Connect the Cable TV signal to one end of the supplied L-Adapter as shown, and connect the other end of the adapter to the TV jack on the LCD TV.

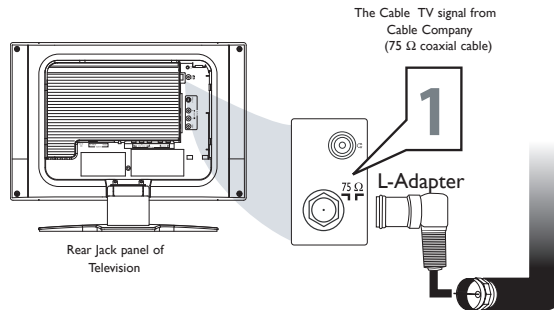

If you have a Cable Box, follow either set of these steps to complete your connections.

Cable Box with RF In/Out Jacks

This connection will not supply Stereo sound to the LCD TV.

- 1 Connect the Cable TV signal to the IN jack (or RF IN or CABLE IN) on the Cable Box.
- 2 Connect an RF coaxial cable (not supplied) to the OUT jack (or TO TV or RF OUT) of the Cable Box.
- 3 Connect the other end of the coaxial cable to one end of the supplied L-Adapter as shown, and connect the other end of the adapter to the TV jack on the LCD TV.
- 4 Plug the DC adapter into the DC IN 16V jack on the LCD TV. Plug the power cable into an outlet.
- 5 Set the Channel 3/4 (or Output channel) switch of the Cable Box to 3 or 4. Set the TV to the same channel. When watching TV programming, change channels at the Cable Box, not the LCD TV.

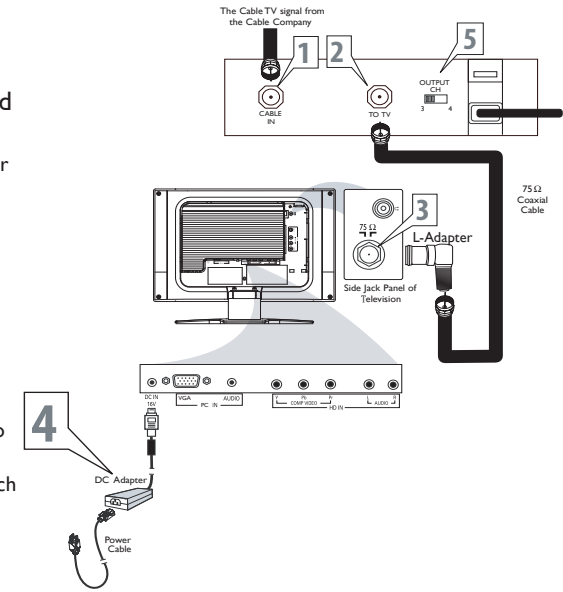
**Cable Box with Audio/Video Out Jacks**

This connection will supply Stereo sound to the LCD TV.

- 1 Connect the Cable TV signal to the IN jack (or RF IN or CABLE IN) on the Cable Box.
- 2 Using an RCA-type video cable (not supplied) connect one end of the video cable to the Video Out jack of the Cable Box. Connect the other end of the cable to the yellow VIDEO jack on the side of the TV. Video cables are usually marked with yellow and are available from Magnavox or electronics retailers. Video jacks on most equipment are yellow.
- 3 Using RCA-type, stereo audio cables (not supplied), connect one end of the cables to the left and right Audio Out jacks of the Cable Box. Connect the other end of that cable to the Audio jack on the side of the LCD TV. Audio cables are usually marked with red and white and are available from Magnavox or electronics retailers. The right audio jack is red and the left audio jack is white. Match the cable colors to the jack colors.
- 4 Plug the DC adapter into the DC IN 16V jack on the LCD TV. Plug the power cable into an outlet.

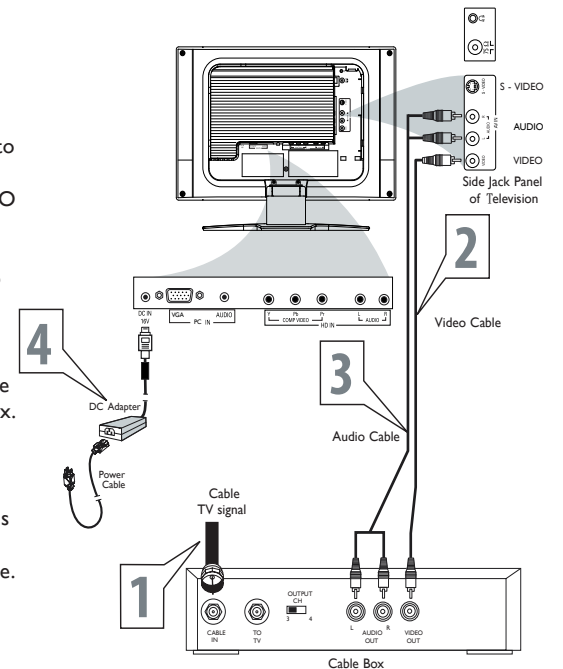

The AUDIO and VIDEO In jacks on the rear of the LCD TV enable quick connections of other equipment. Connect a VCR, DVD Player, Video Game, Camcorder, etc., to these jacks. To view the material playing on the other equipment, set the LCD TV to its AV Mode.

- 1 Connect a RCA-style video cable (usually yellow or marked CVBS) to the VIDEO OUT jacks of the other equipment (DVD Player, Camcorder, etc.) and to the yellow VIDEO jack on the side of the LCD TV.
- 2 Connect RCA-style audio cables (usually red and white) to the AUDIO OUT (left and right) jacks on the other equipment. Connect the other end of the cables to the AUDIO jack on the side of the LCD TV.
- 3 Plug the DC Adapter into the DC IN 16V jack on the TV. Plug the power cable into an outlet. Turn on the TV and other equipment.
- 4 Press the Source button to set the TV to AV Mode.
- 5 Press PLAY on the other equipment to view its material on the TV.

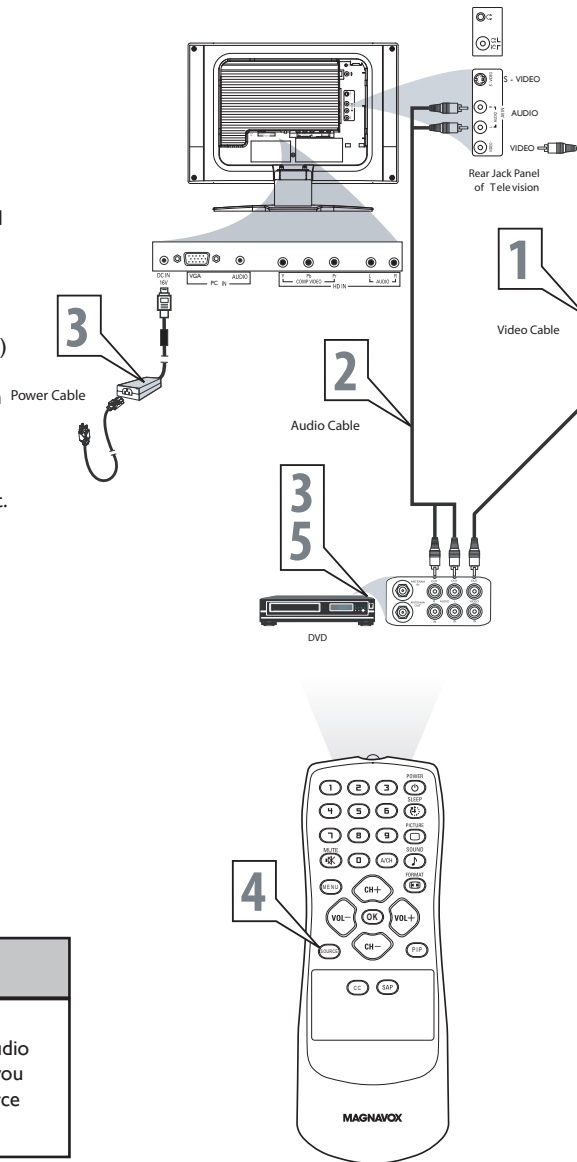

HELPFUL HINT

The Audio jack of AV IN is shared between Video (CVBS) and S-Video signals. If Audio and Video is connected to Video (CVBS) input, you can still hear sound if you select S-Video via Source select, even there appears no image on screen.

The S-Video connection on the rear of the LCD TV can provide you with better picture detail and clarity for the playback of accessory sources such as DBS (digital broadcast satellite), DVD (digital video discs), video games, and VHS VCR (video cassette recorder) tapes than the normal antenna picture connections.

Note: The accessory device must have an S-VIDEO OUT (put) jack in order for you to complete the connection on this page.

- 1 Connect an S-Video cable to the S-VIDEO jack of the other equipment (DVD Player, Camcorder, etc.) and to the S-VIDEO jack on the rear of the LCD TV.
- 2 Connect RCA-style audio cables (usually red and white) to the AUDIO OUT (left and right) jacks on the other equipment. Connect the other end of the cables to the AUDIO jack on the side of the LCD TV.
- 3 Plug the DC Adapter into the DC IN 16V jack on the LCD TV. Plug the power cable into an outlet. Turn on the LCD TV and other equipment.
- 4 Press the Source button to set the LCD TV to its S-VIDEO mode.
- 5 Press PLAY on the other equipment to view its material on the LCD TV.

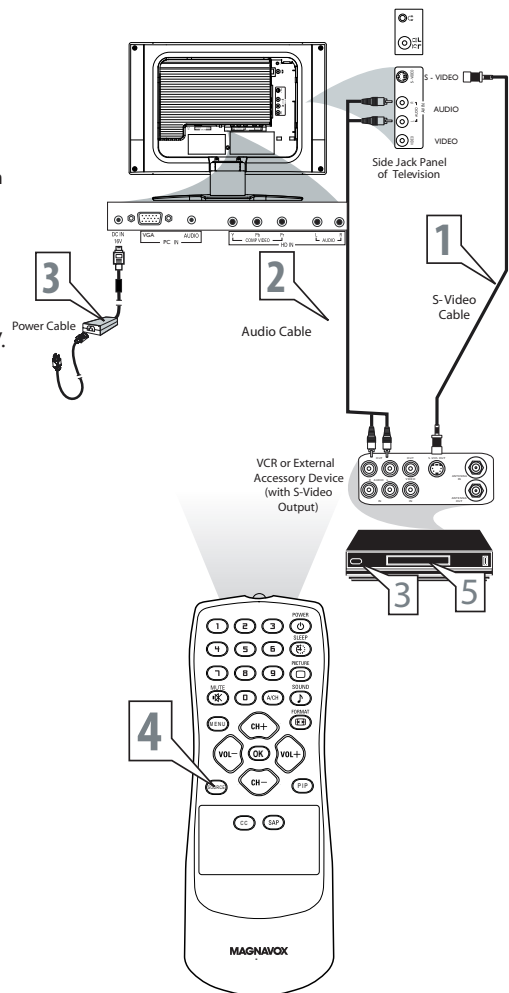

HELPFUL HINT

The Audio jack of AV IN is shared between Video (CVBS) and S-Video signals. If Audio and Video is connected to S-Video input, you can still hear sound if you select Video via Source select, even there appears no image on screen.

Component Video input provide the highest possible color and picture resolution in the playback of digital signal source material, such as with DVD players.

Note: The accessory device must have an component (YPbPr) output jack in order for you to complete the connection on this page.

- 1 Connect the component (Y, Pb, Pr) Video OUT jacks from the DVD player (or similar device) to the COMP(onent) VIDEO Input jacks on the bottom of the LCD TV.
- 2 Connect the red and white AUDIO CABLES to the Audio (left and right) output jacks on the rear of the accessory device to the AUDIO IN jack. Connect the other end of the cable to the Audio jack on the rear of LCD TV.
- 3 Plug the DC Adapter into the DC IN 16 V jack on the LCD TV. Plug the power cable into an outlet. Turn on the LCD TV and other equipment.
- 4 Press the SOURCE button on the remote control to select HD. HD will appear in the upper left corner on the TV screen.
- 5 Insert a DVD disc into the DVD player and press the PLAY button on the DVD Player.

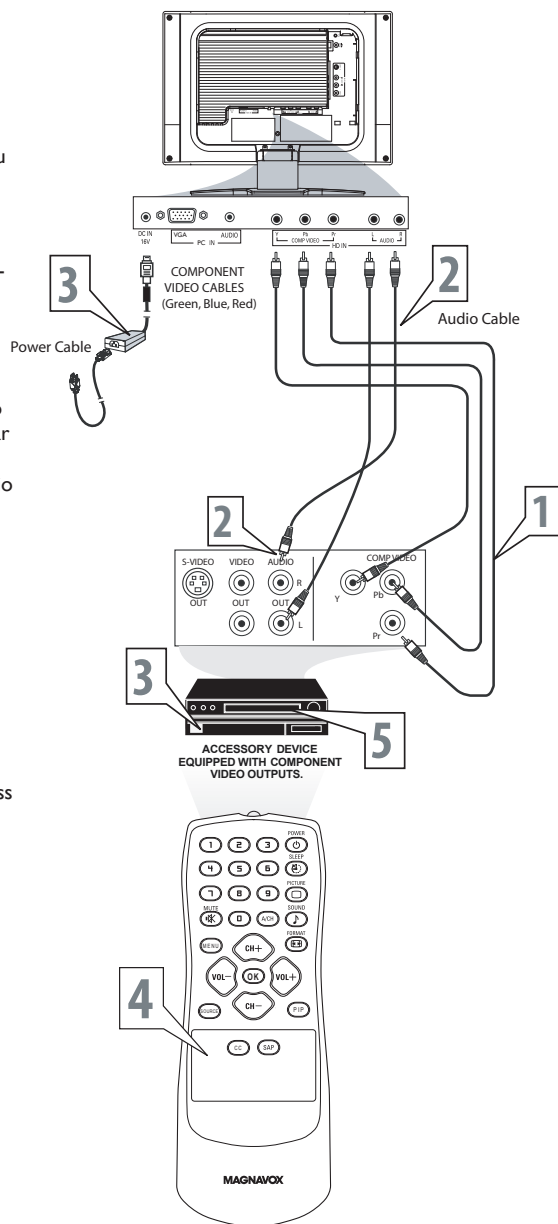

This LCD TV can be used as a PC. Your computer will have to be equipped with a VGA type video output and VGA cable.

- 1 Connect one end of the VGA Video cable (not supplied) to the Monitor (video) output on the computer, while connecting the other ends to the VGA INPUT jack on the LCD TV.
- 2 Although audio connections are not required, the LCD TV can reproduce the computers audio out by an AUDIO ADAPTER to the Audio output jack on the computer (if available) while connecting the other ends of the Audio cables to the PC AUDIO Jacks on the bottom of the TV.
- 3 Plug the DC Adapter into the DC IN 16V jack on the LCD TV. Plug the power cable into an outlet. Turn on the LCD TV and PC.
- 4 Press the SOURCE button until PC MODE appears on the screen.

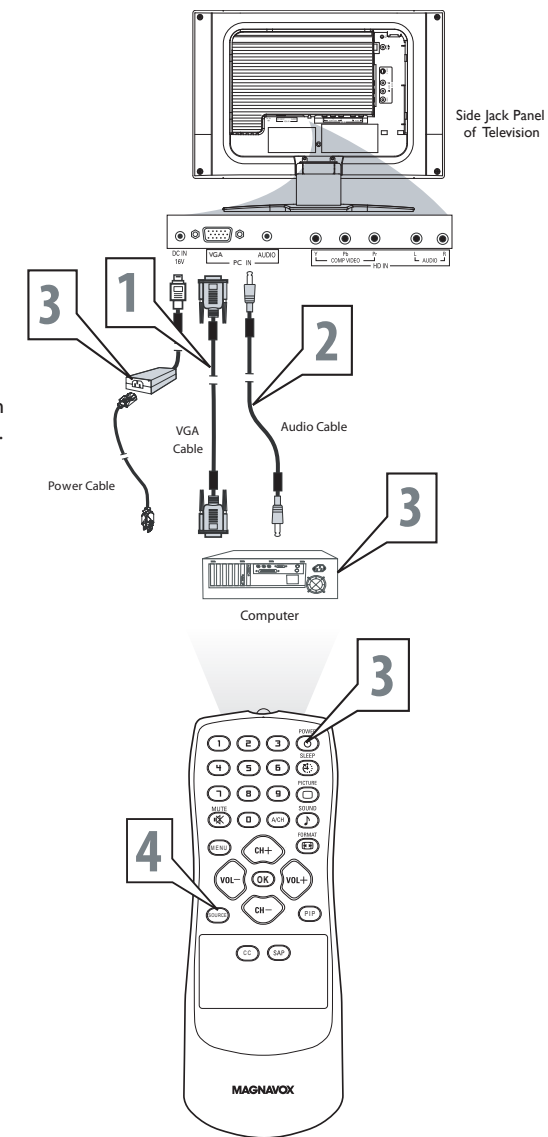



For English, French or Spanish-speaking TV owners, an onscreen LANGUAGE option is present. The LANGUAGEM control enables you to set the TV's onscreen menu to be shown in either English, French or Spanish.

- 1 Press the MENU (MENU) button on the remote control to see the onscreen menu.
- 2 Press the (CH-) (CH-) button to highlight the INSTALL menu.
- 3 Press the (VOL+) (VOL+) button to enter the INSTALL menu.
- 4 Press the (VOL+) (VOL+) button to select English, French or Spanish.
- 5 Press the MENU (MENU) button repeatedly to clear the menu from the screen.

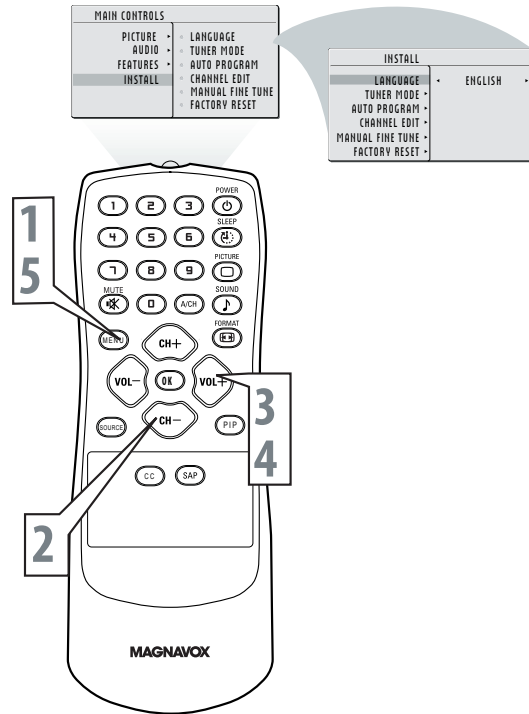

HELPFUL HINT

Remember, the LANGUAGE control makes only the TV's onscreen MENU items appear in English, French or Spanish text. It does not change the other onscreen text features, such as Closed Captioning (CC), with TV shows.



The Tuner Mode allows you to change the LCD TV's signal input to Cable or Air (antenna). It's important for the LCD TV to know if you want to receive channels from a cable TV signal or an antenna signal.

- 1 Press the Menu (MENU) button to see the onscreen menu.
- 2 Press the (CH-) (CH-) button to highlight the INSTALL menu.
- 3 Press the (VOL+) (VOL+) button to enter the INSTALL menu.
- 4 Press the (CH-) (CH-) button to highlight the TUNER MODE menu.
- 5 Press the (VOL+) (VOL+) or (VOL-) (VOL-) buttons to select CABLE, AIR (antenna), or AUTO.
- 6 Press the MENU (MENU) button repeatedly to clear the menu from the screen.

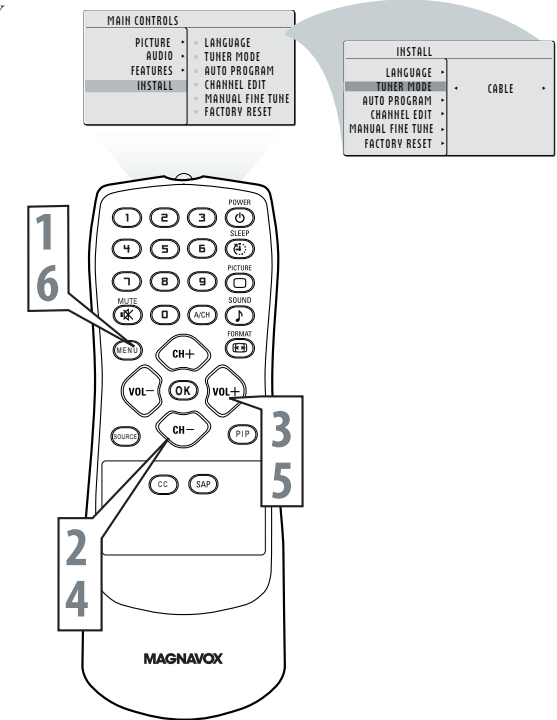

HELPFUL HINT

- When CABLE is selected, channels 1-125 are available.
- When ANTENNA is selected, channels 2-69 are available.
- When AUTO is selected, your LCD TV will search automatically for antenna and cable channels.

Your LCD TV can automatically set itself for local area (or cable TV) channels. This makes it easy for you to select only the TV stations in your area by pressing the CH (+) or CH (-) button.

- 1 Press the MENU (MENU) button on the remote control to show the onscreen menu.
- 2 Press the (CH-) (CH-) button to highlight the INSTALL menu.
- 3 Press the (VOL+) (VOL+) button to enter the INSTALL menu.
- 4 Press the (CH-) (CH-) button to highlight the AUTO PROGRAM control.
- 5 Press the (VOL+) (VOL+) button to start the AUTO PROGRAM scanning of channels.
- 6 Press the MENU (MENU) button repeatedly to clear the menu from the screen, after AUTO STORE has finished.

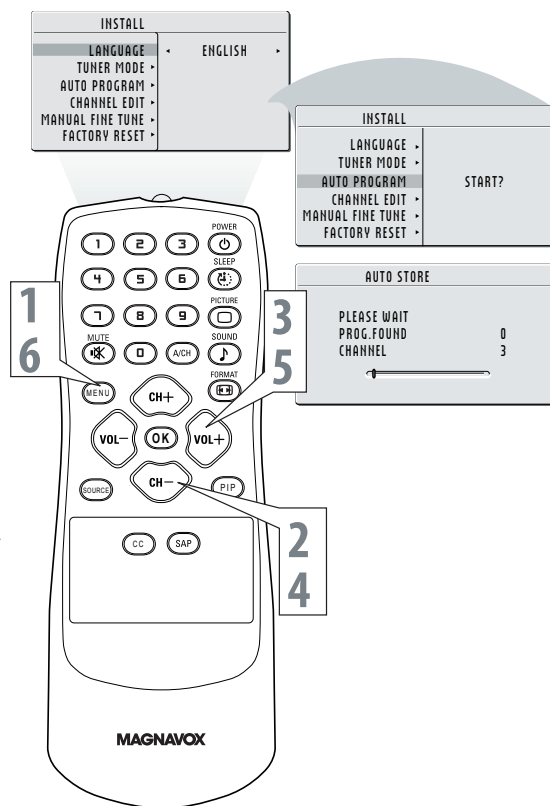

Channel Edit control lets you edit the channel listing. You can add or remove a channel in the LCD TV's memory.

- 1 Press the Menu (MENU) button to see the onscreen menu.
- 2 Press the (CH-) (CH-) button to highlight the INSTALL menu.
- 3 Press the (VOL+) (VOL+) button to enter the INSTALL menu.
- 4 Press the (CH-) (CH-) button to highlight the CHANNEL EDIT menu.
- 5 Press the (VOL+) (VOL+) button to enter the CHANNEL EDIT menu.
- 6 In CHANNEL column, press (VOL+) (VOL+) or (VOL-) (VOL-) to select the channel you wish to add or remove.
- 7 In SKIPPED column, press (VOL+) (VOL+) or (VOL-) (VOL-) to select ACTIVE (to add) or SKIPPED (to delete) the channel you selected.
- 8 Press the MENU (MENU) button repeatedly to clear the menu from the screen.

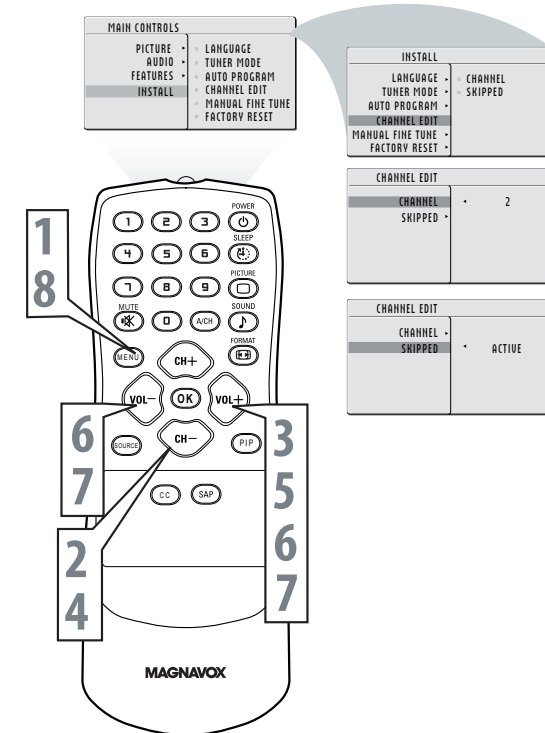

HELPFUL HINT

After you've run Auto Program, check out the results. Press the CH+ (CH+) or the CH- (CH-) button and see which channels you can select.

Remember, an antenna or cable TV signal must first be connected to your LCD TV (see pages 8-9 of this owner's manual).

HELPFUL HINT

Repeat steps 6-7 to add or delete additional channels to or from the LCD TV's memory.



Your TV can be reset to the original factory settings by performing the following steps.

- 1 Press the MENU button on the remote control to see the onscreen menu.
- 2 Press the (CH-) button to highlight the INSTALL menu.
- 3 Press the (VOL+) button to enter the INSTALL menu.
- 4 Press the (CH-) button to highlight the FACTORY RESET control.
- 5 Press the (VOL+) button to reset the TV to the original factory settings.
- 6 Press the MENU button repeatedly to clear the menu from the screen.

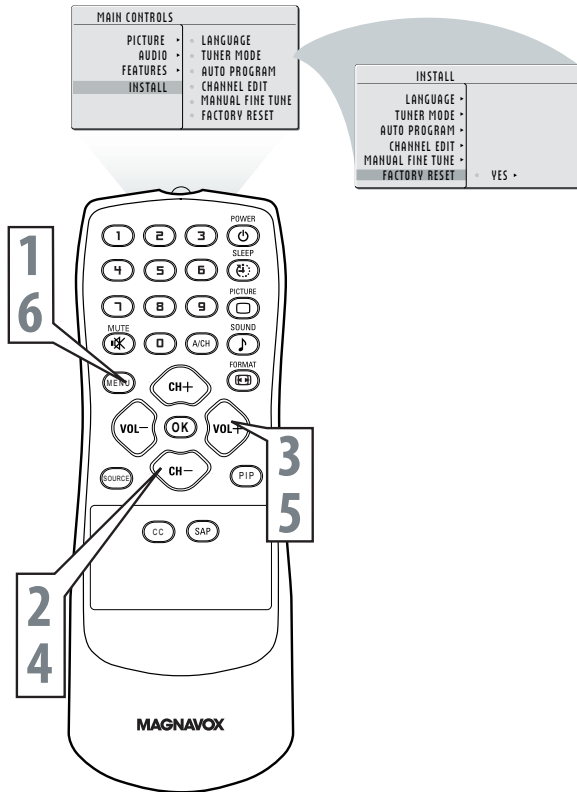

HELPFUL HINT

If you reset the TV to the factory settings, all your present setting on picture, audio, Close Caption and other feature settings will be erased and replaced by the manufacture's default settings. However, your AutoLock access code will not be erased. Please refer to page 23 for details.



Whether you're watching a movie or a video game, your LCD TV has video control preset that will match with your current program source or content. Smart Picture quickly resets your TV's video controls for a number of different types of programs and viewing conditions that you may have in your home. The Movies, Sports, Weak Signal, Multimedia, and Night Smart Picture controls have been preset at the factory to easily adjust the TV's brightness, color, picture, sharpness, tint, and color temperature levels. In the Personal smart picture mode you can create your own preferred video settings.

- 1 Press the PICTURE button on the remote control. The current Smart Picture setting will appear on the screen.
- 2 Press the PICTURE button repeatedly to select either Personal, Movies, Sports, Weak Signal, Multimedia, and Night Smart Picture settings.

Note: The settings of the Personal smart picture mode can be adjusted in picture options within the onscreen menu. The Personal mode is the only mode which can be adjusted by the user via the onscreen picture control menu.

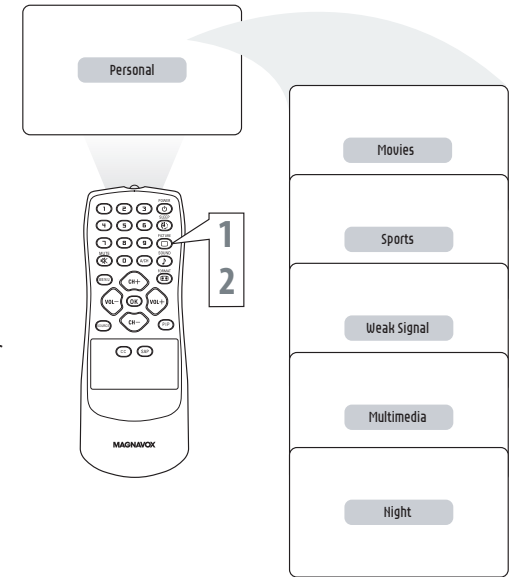

SMART SOUND CONTROL



Smart Sound allows you to select from three user presets and a personal mode that you set according to your own preferences through the onscreen Sound menu. The three user presets (News, Music, and Theatre) enable you to tailor the TV sound so as to enhance the particular program you are watching. Following these steps to select any of the options.

- 1 Press the Sound button on the remote control. The current Smart Sound setting will appear on the screen.
- 2 Press the Sound button repeatedly to toggle among the four settings: Personal, News, Music, or Theatre.

Note: The settings of the Personal smart sound mode can be adjusted in sound control within the onscreen menu. The Personal mode is the only mode which can be adjusted by the user via the onscreen sound control menu.

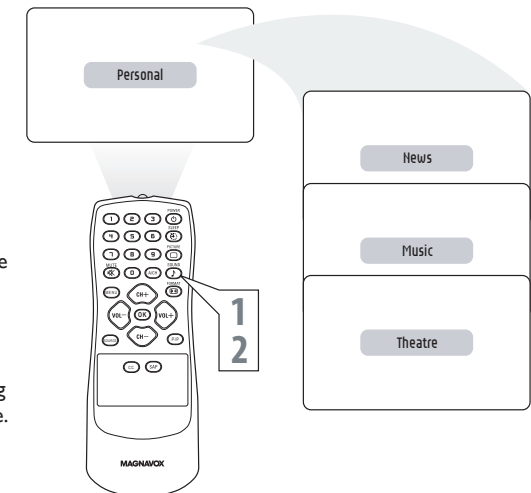

To adjust your LCD TV picture, select a channel and follow these steps.

- 1 Press the MENU (MENU) button to see the onscreen menu.
- 2 When PICTURE menu is highlighted, press the (VOL+) (VOL+) button to enter the PICTURE menu.
- 3 Press the (CH+) (CH+) or (CH-) (CH-) button to choose the item you want to adjust: Smart Picture, Brightness, Color, Contrast, Sharpness or Tint.

Smart Picture: Please refer to page 20, for details on Smart Picture Settings.

Brightness: Adjust to brighten the dark parts of the picture. This appears to add white to the color.

Color: Adjust to add or reduce color.

Contrast: Adjust to “sharpen” the Picture quality. The black portions of the picture become richer in darkness and the white become brighter.

Sharpness: Adjust to improve detail.

Tint: Adjust to obtain natural skin tones.

- 4 Press the (VOL+) (VOL+) or (VOL-) (VOL-) button to adjust the item.
- 5 Press the (CH+) (CH+) or (CH-) (CH-) button to select and adjust other picture controls.
- 6 Press the MENU (MENU) button repeatedly to remove the menu.

HELPFUL HINT

Brightness, color, contrast and sharpness can only be accessed when Smart Picture is set to PERSONAL.

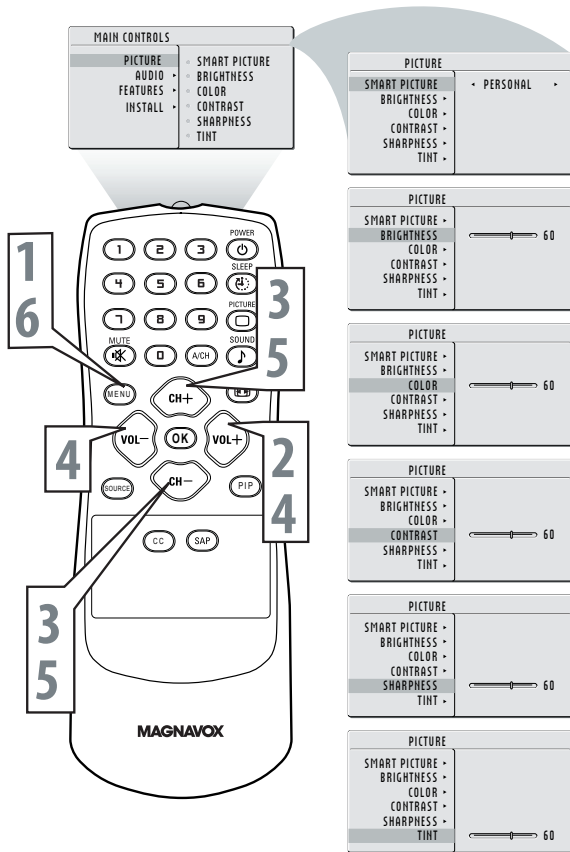

To adjust your LCD TV Sound, select a channel and follow these steps.

- 1 Press the MENU (MENU) button to see the menu.
- 2 Press the (CH-) (CH-) button to highlight the AUDIO menu.
- 3 Press the (VOL+) (VOL+) button to enter the AUDIO menu.
- 4 Press the (CH+) (CH+) or (CH-) (CH-) button to choose the item you want to adjust: Smart Sound, Settings, Stereo, Virtual Surround, AVL.
- 5 Press the (VOL+) (VOL+) or (VOL-) (VOL-) button to adjust the item.
- 6 Press the (CH+) (CH+) or (CH-) (CH-) button to select and adjust other sound controls.
- 7 Press MENU (MENU) to remove the menu.

Smart Sound: Please refer to page 19 for details on Smart Sound Settings.

Settings: Allows you to adjust Treble, Bass, and Balance of the sound.

Stereo: Adjust to select between Stereo, Mono, or SAP.

Virtual Surround: Adds greater depth and dimension to TV sound. Select from Virtual Surround or OFF.

AVL (Auto Volume Leveler): When On, AVL will level out the sound being heard when sudden changes in volume occur during commercial breaks or channel changes.

HELPFUL HINT

- Treble and Bass can only be accessed when Smart Sound is set to Personal.
- If Stereo is not presented on a selected show and the TV is placed in Stereo mode, the sound coming from TV will remain in Mono mode.

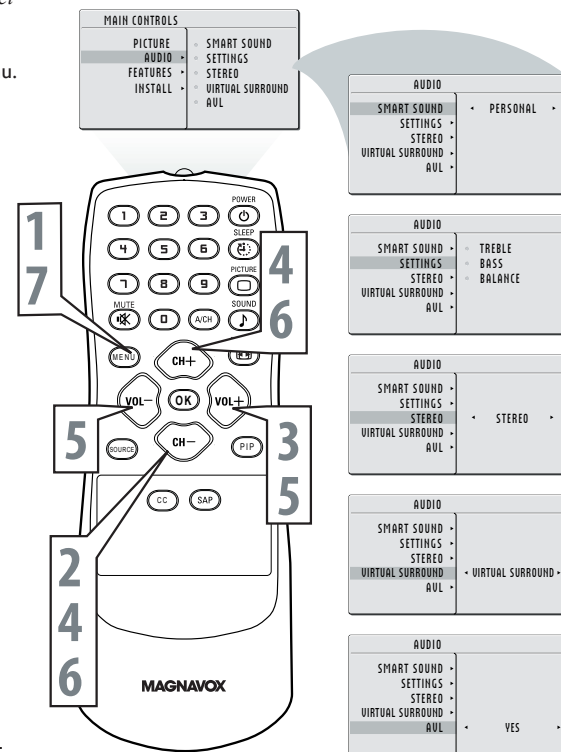



The AUTO Lock feature is an integrated circuit that receives and processes data sent by broadcasters, or other program providers, that contain program content advisories. When programmed by the viewer, a TV with AUTO Lock can respond to the content advisories and block program content that may be found objectionable (such as offensive language, violence, sexual situations, etc.). This is a great feature to censor the type of viewing children may watch.

AUTO Lock offers various BLOCKING controls from which to choose:

Access Code - An Access Code must be set to prevent children from unblocking questionable or censored programming set by their parents.

Block Enable - After an access code has been programmed, you can block programming depending on the received rating and user setting.

Movie Ratings - Certain blocking options exist which will block programming based on ratings patterned by the Motion Pictures Association of America.

TV Ratings - Just like the Movie Ratings, programs can be blocked from viewing using standard TV ratings set by TV broadcasters.

| MOVIE RATING | |
|--------------|----|
| G | OH |
| PG | |
| PG13 | |
| R | |
| NC17 | |
| X | |

MOVIE RATINGS

G: General Audience - All ages admitted. Most parents would find this program suitable for all ages. This type of programming contains little or no violence, no strong language, and little or no sexual dialog or situations.

PG: Parental Guidance Suggested - This programming contains material that parents may find unsuitable for younger children. It may contain one or more of the following: moderate violence, some sexual situations, infrequent coarse language, or some suggestive dialog.

PG-13: Parents Strongly Cautioned - This programming contains material that parents may find unsuitable for children under the age of 13. It contains one or more of the following: violence, sexual situations, coarse language, or suggestive dialog.

R: Restricted - This programming is specifically designed for adults. Anyone under the age of 17 should only view this programming with an accompanying parent or adult guardian. It contains one or more of the following: intense violence, intense sexual situations, strong coarse language, or intensely suggestive dialog.

NC-17: No children under the age of 17 will be admitted. - This type of programming should be viewed by adults only. It contains graphic violence, explicit sex, or crude, indecent language.

X: Adults Only - This type of programming contains one or more of the following: very graphic violence, very graphic and explicit or indecent sexual acts, and very coarse and intensely suggestive language

| TV RATING | |
|-----------|----|
| V | OH |
| V7 | |
| G | |
| PG | |
| 14 | |
| MA | |

TV RATINGS

TV-Y All children - Appropriate for all children. Designed for a very young audience, including children ages 2-6. This type of programming is not expected to frighten younger children.

TV-Y7 Directed to Older Children - Designed for children age 7 and above. It may be more appropriate for children who can distinguish between make-believe and reality. This programming may include mild fantasy and comic violence (FV or fantasy violence).

TV-G General Audience - Most parents would find this programming suitable for all ages. This type of programming contains little or no violence, no strong language, and little or no sexual dialog or situations.

TV-PG Parental Guidance Suggested - Contains material that parents may find unsuitable for younger children. This type of programming contains one or more of the following: Moderate violence (V), some sexual situations (S), infrequent coarse language (L), or some suggestive dialog (D).

TV-14 Parents Strongly Cautioned - Contains some material that many parents would find unsuitable for children under age 14. This type of programming contains one or more of the following: intense violence (V), intense sexual situations (S), strong coarse language (L), or intensely suggestive dialog (D).

TV-MA Mature Audience Only - Specifically designed to be viewed by adults and may be unsuitable for children under 17. This type of programming contains one or more of the following: graphic violence (V), explicit sexual situations (S), or crude, indecent language (L)



Over the next few pages you'll learn how to block programs and understand the rating terms for certain broadcasts. First, set an access code.

- 1 Press the MENU button to see the onscreen menu.
- 2 Press the (CH-) button to highlight the FEATURES menu.
- 3 Press the (VOL+) button to enter the FEATURES menu.
- 4 Press the (CH-) button to select AUTO LOCK.
- 5 Press the (VOL+) button CHANGE CODE will appear on the screen.
- 6 Enter a four-digit code using the Number buttons. The screen will prompt you to confirm the code you just entered. Enter your same new code again.
- 7 Press MENU repeatedly to remove the menu from the screen.

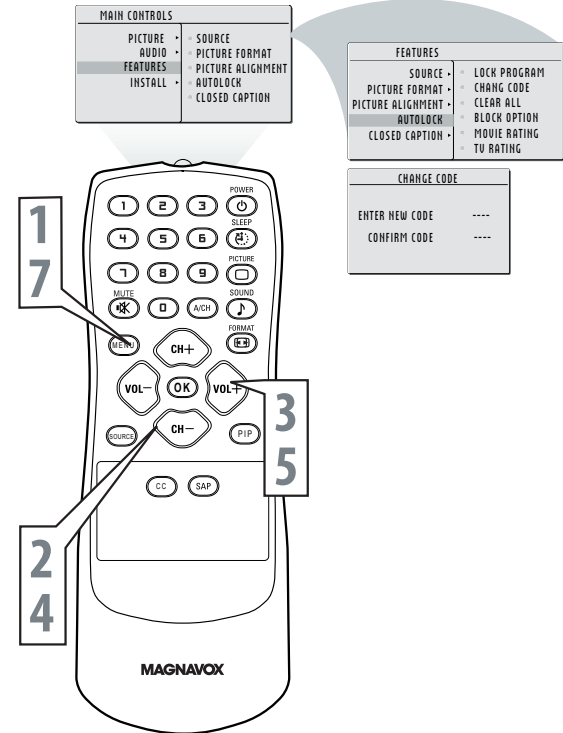

HELPFUL HINT

Remember that 0711 is the default AutoLock code. If your access code has been changed by someone other than you (a child, for example) or you have forgotten the code, you can always get in by inputting the default code.

NOTE TO PARENTS:

It is not possible for your child to unblock a channel without knowing your access code or changing it to a new one. If your code has been changed without your knowledge, then you will become aware that blocked channels may have been viewed.



After your personal access code has been set (see the previous page), you are ready to select the channels or inputs you want to block out or censor.

- 1 Press the MENU button to see the onscreen menu.
- 2 Press the (CH-) button to highlight the FEATURES menu.
- 3 Press the (VOL+) button to enter the FEATURES menu.
- 4 Press the (CH-) button to select AUTO LOCK.
- 5 Press the (VOL+) button to enter AUTO LOCK menu.
- 6 Use the Number buttons to enter your access code.
- 7 Press the (VOL+) button to block current selected channel or (VOL-) button to unblock a channel.
- 8 Press MENU repeatedly to remove the menu from the screen.

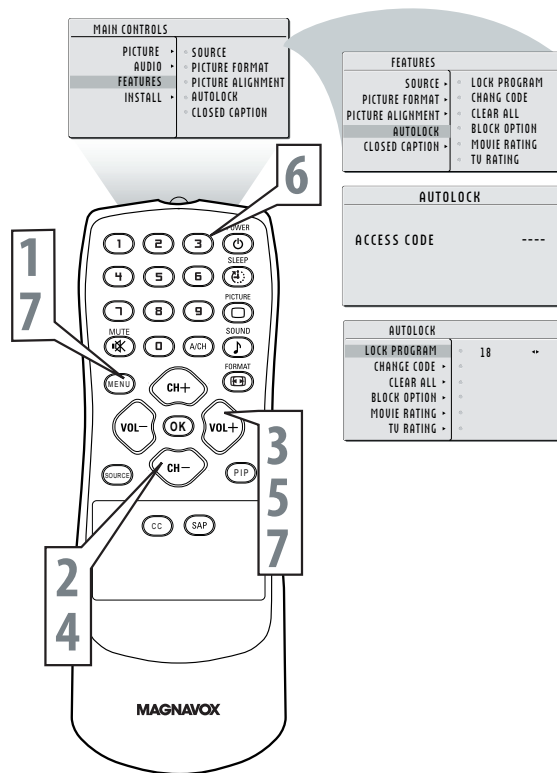

Note: You can block additional channels by using Number buttons to jump to another channel.



The AUTO Lock feature can block programming based on the Movie Industry ratings. Once you've entered your access code and the AUTO Lock features are displayed on the screen:

- 1 Press the MENU button to see the onscreen menu.
- 2 Press the (CH-) button to highlight the FEATURES menu.
- 3 Press the (VOL+) button to enter the FEATURES menu.
- 4 Press the (CH-) button to select AUTO LOCK.
- 5 Press the (VOL+) button, INPUT USER CODE will appear.
- 6 Use the Number buttons to enter your access code.
- 7 Press the (CH-) button to select MOVIE RATING.
- 8 Press the (VOL+) button to highlight any of the Movie Rating options. When highlighted, all these options can be (ON) blocked or (OFF) unblocked.
- 9 Press MENU repeatedly to remove the menu from the screen.

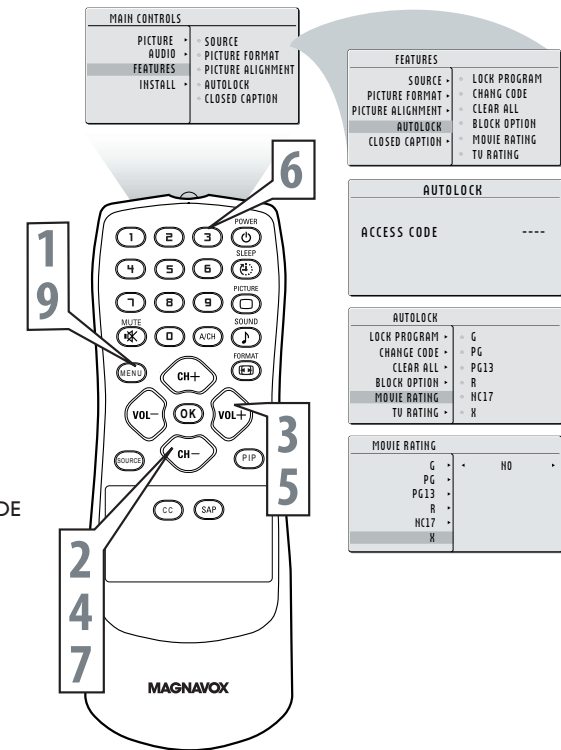

HELPFUL HINT

When a rating is chosen to be blocked, any higher level rating will also be blocked from viewing. (i.e.: If "R" is selected to be blocked, NC-17 and X will automatically be blocked.) Also, when a rating is set to unblock, any rating lower will be automatically set to unblock. (i.e.: if PG-13 is unblocked, PG and G will automatically be unblocked.)

The AUTO Lock feature can block programming based on the TV Industry ratings. Once you've entered your access code and the AUTO Lock features are displayed on the screen:

- 1 Press the MENU button to see the onscreen menu.
- 2 Press the (CH-) button to highlight the FEATURES menu.
- 3 Press the (VOL+) button to enter the FEATURES menu.
- 4 Press the (CH-) button to highlight AUTO Lock.
- 5 Press the (VOL+) button, INPUT USER CODE will appear on the screen.
- 6 Use the Number buttons to enter your access code.
- 7 Press the (CH-) button to select TV RATING.
- 8 Press the (VOL+) or (VOL-) button to highlight any of the TV Rating options. When highlighted, all these options can be (ON) blocked or (OFF) unblocked.
- 9 Press MENU repeatedly to remove the menu from the screen.

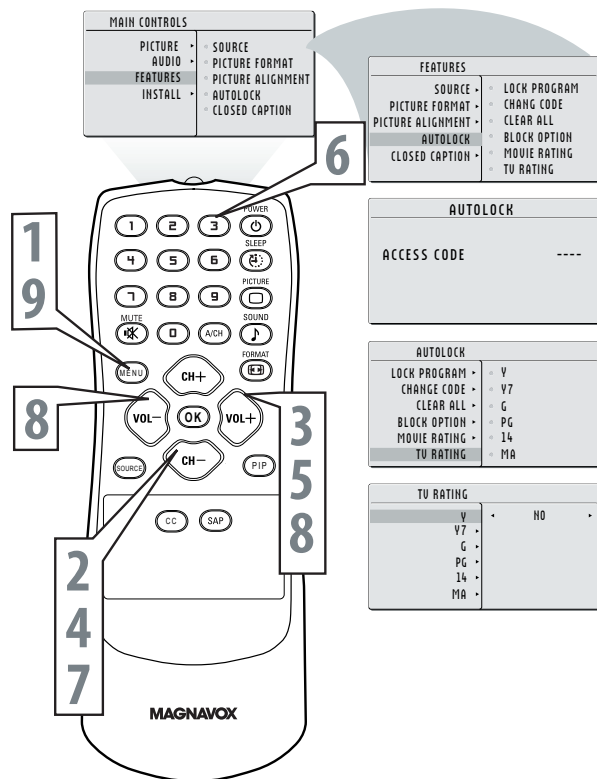

You can change the picture format size to match the type of program you are watching. Select the normal 4:3, EXPAND 4:3, or COMPRESS 16:9, or HD 4:3 aspect ratios.

- 1 Press the MENU button to see the onscreen menu.
 - 2 Press (CH-) button to highlight the FEATURES menu.
 - 3 Press (VOL+) button to enter the FEATURES menu.
 - 4 Press (CH-) button to highlight the PICTURE FORMAT menu.
 - 5 Press (VOL+) button to change the PICTURE FORMAT.
- Note: Press the FORMAT button repeatedly to toggle among the four screen format sizes; 4:3, EXPAND 4:3, or COMPRESS 16:9, or HD 4:3.
- 6 Press MENU repeatedly to remove the menu from the screen.
- Note: HD 4:3 Picture Format is available in HD Mode with 720p/1080i only.

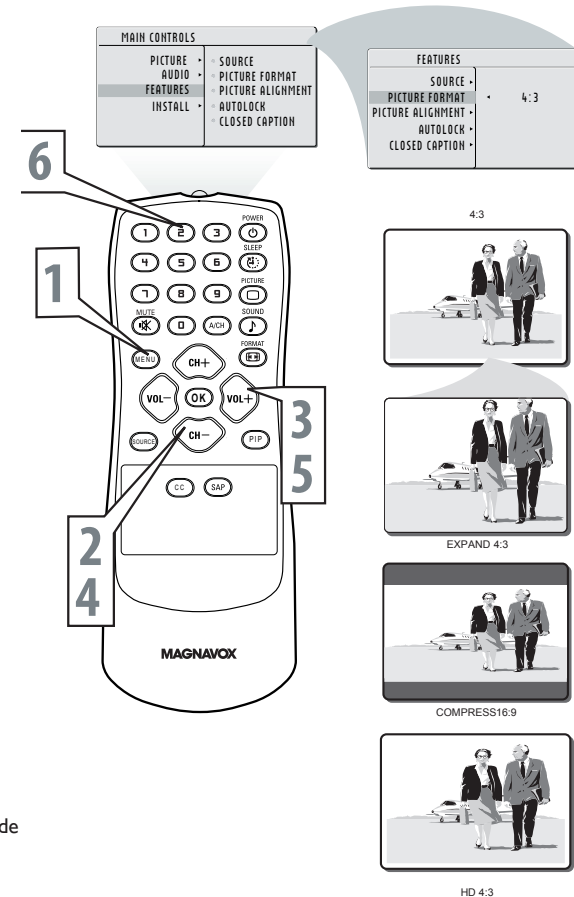



Closed Captioning (CC) allows you to read the voice content of television programs on the TV screen. Designed to help the hearing impaired, this feature uses onscreen "text boxes" to show dialogue and conversations while the TV program is in progress.

- 1 Press the MENU (MENU) button to see the onscreen menu.
- 2 Press the (CH -) (CH-) button to highlight the FEATURES menu.
- 3 Press the (VOL+) (VOL+) button to enter the FEATURES menu.
- 4 Press the (CH -) (CH-) button to select CLOSE CAPTION.
- 5 Press the (VOL+) (VOL+) button to select the closed caption you want: CC MUTE, CCI, CC2, CC3, CC4, Txt1, Txt2, Txt3 or Txt4.

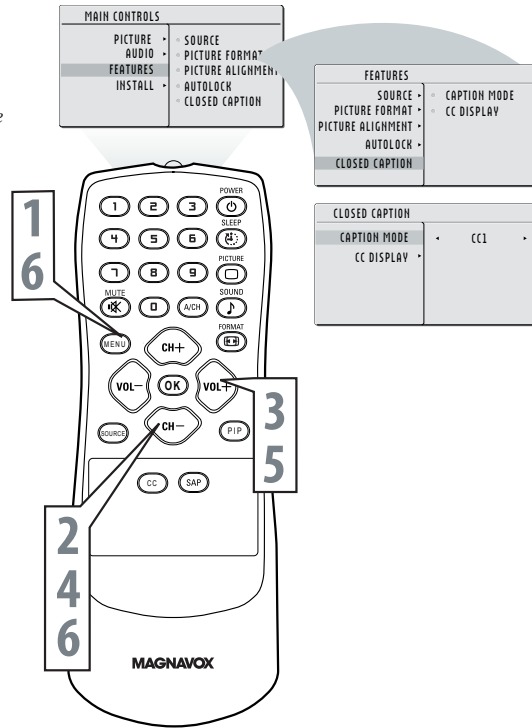

Note: Closed Caption can also be activated by pressing CC button on your remote control.

HELPFUL HINT

Not all TV programs and product commercials are broadcast with Closed Captioning (CC). Nor are all Closed Captioning MODES (CAPTION 1-4 or TEXT 1-4) necessarily being used by broadcast stations during the transmission of a program offering Closed Captioning. Refer to your area's TV program listings for the stations and times of shows being broadcast with Closed Captioning.



This TV can also be used as a PC Monitor. A PC video signal must be present or the TV will go into standby mode. The PC Picture controls allow you to adjust the picture.

Note: Make sure you are in PC mode.

- 1 Press the MENU (MENU) button on the remote control to see the onscreen menu.
- 2 When the PICTURE menu is highlighted, press the (VOL+) (VOL+) button to enter the PICTURE menu.
- 3 Press the (CH +) (CH+) or (CH -) (CH-) button to highlight the item that you would like to adjust.
 - Smart Picture:** Adjust the color temperature of the picture. Select from Normal, Cool, or Warm.
 - Brightness:** Adjust to brighten the darkest parts of the picture.
 - Contrast:** Adjust to "sharpen" the Picture quality. The black portions of the picture become richer in darkness and the white become brighter.
 - Auto Adjust:** The LCD Monitor will automatically adjust to the best image position, phase, and clock setting.
 - Manual Adjust:** The Manual Adjust control allow you to manually fine tune the image as it appears on the screen.
 - Phase-eliminates** the horizontal interfering lines.
 - Clock-eliminates** the vertical interfering lines.
 - Horizontal-adjust** the horizontal placement of the picture.
 - Vertical-adjust** the vertical placement of the picture.
- 4 Press the (VOL+) (VOL+) or (VOL-) (VOL-) button to adjust the item.
- 5 Press MENU (MENU) repeatedly to remove the menu from the screen.

Note: To adjust other items repeat steps 4 and 5.

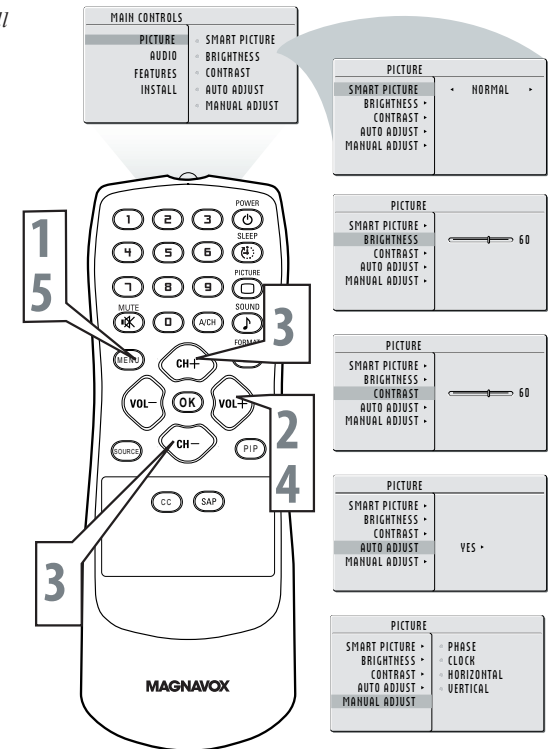



This TV can also be used as a PC Monitor. A PC video signal must be present or the TV will go into standby mode. The AUDIO controls allow you to adjust the sound.

Note: Make sure you are in PC mode.

- 1 Press the MENU (MENU) button on the remote control to show the onscreen menu.
- 2 Press the (CH-) (CH-) button to highlight the AUDIO menu.
- 3 Press the (VOL+) (VOL+) button to shift the menu to the right to enter the AUDIO menu.
- 4 Press the (CH+) (CH+) or (CH-) (CH-) button to highlight the item that you would like to adjust:
Smart Sound: Allows you to select from 3 factory-set controls and a personal control. The 3 factory-set controls (News, Music, and Theatre) enhance the particular program you are watching.
Settings: Allows you to adjust Treble, Bass, and Balance of the Sound.
Stereo: To select from Stereo, Mono, and SAP.
Virtual Sound: Adds greater depth and dimension to PC sound.
AVL (Auto Volume Leveler)- When ON, AVL will level out the sound being heard when sudden changes in volume occur during commercial breaks or channel changes.
- 5 Press the (VOL+) (VOL+) or (VOL-) (VOL-) buttons to adjust the item.
- 6 Press MENU (MENU) repeatedly to remove the menu from the screen.

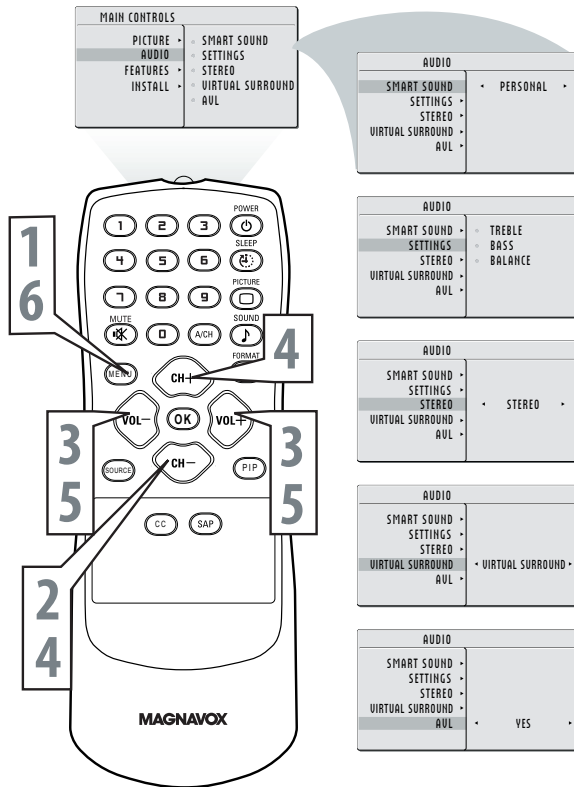

PIP (Picture-in-Picture) feature allows you to call up a subscreen when you are using your TV as a monitor.

Note: Make sure you are in PC mode.

- 1 Press the MENU (MENU) button to see the onscreen menu.
- 2 Press (CH-) (CH-) button to highlight the FEATURES menu.
- 3 Press (VOL+) (VOL+) button to enter the FEATURES menu.
- 4 Press (VOL+) (VOL+) button to enter the PIP menu.
- 5 Press the (CH+) (CH+) or (CH-) (CH-) buttons to highlight the item that you would like to adjust.
SIZE: Turn off and set the size of PIP. You can choose your preferred size of small, medium, large, or PBP (Picture Beside Picture).
Video: Select video source of PIP from AV, S-Video, TV, or Component.
Audio: Select audio source of PIP or PC.
Display: Select which corner of the position of PIP.

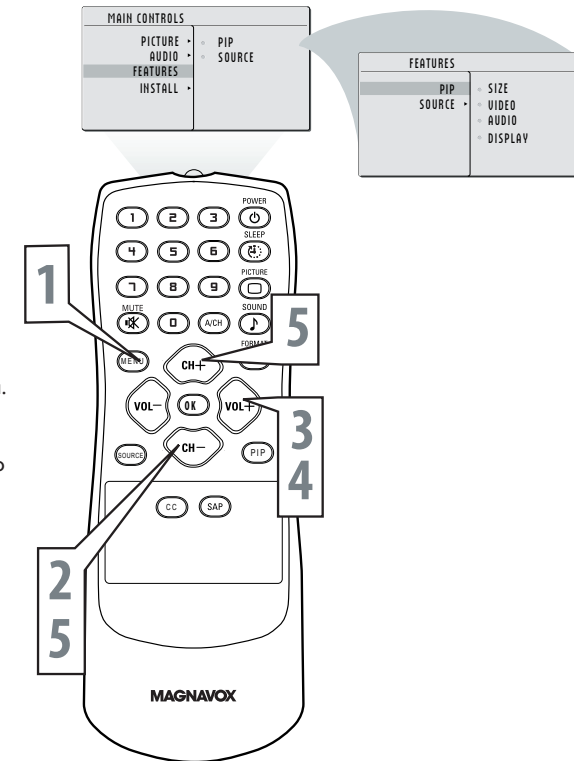

HELPFUL HINT

To adjust other items repeat steps 4 and 5.

HELPFUL HINT

PIP windows with component video source can only support up to 480i (SD) video signal.

**15MF Series (15" LCD TV)**

| No | Resolution | Mode | V. Frequency (Hz) | H. Frequency (kHz) |
|----|------------|--------------|-------------------|--------------------|
| 1 | 640 x 480 | VGA VESA 60 | 59.940 | 31.469 |
| 2 | 800 x 600 | SVGA VESA 56 | 56.250 | 35.156 |
| 3 | | SVGA VESA 60 | 60.317 | 37.897 |
| 4 | 1024 x 768 | XGA VESA 60 | 60.004 | 48.363 |

20MF Series (20" LCD TV)

| No | Resolution | Mode | V. Frequency (Hz) | H. Frequency (kHz) |
|----|------------|--------------|-------------------|--------------------|
| 1 | 640 x 480 | VGA VESA 60 | 59.940 | 31.469 |
| 2 | 800 x 600 | SVGA VESA 56 | 56.250 | 35.156 |
| 3 | | SVGA VESA 60 | 60.317 | 37.897 |

No Power

- Check the TV power cord. Disconnect the power cord from the power outlet for 10 seconds, then reinsert the plug into the outlet. Press POWER to turn on the TV again.
- Make sure the outlet is not on a wall switch.
- Make sure a fuse has not blown at the power outlet.

No Picture

- Check the antenna or Cable TV connections. Connect the antenna or Cable TV signal securely to the TV's 75Ω jack on the rear of the TV.
- Set TUNER MODE correctly. Details are on page 15.
- Activate AUTO PROGRAM to find all available channels. Details are on page 16.
- In case you hear only sound and don't see any picture in S-Video or Video (CVBS) mode. Please check if you have connected Video signal to S-Video or Video (CVBS) input. Only one of the two video inputs can be connected to sound. This means that the same sound can be heard in S-Video and Video (CVBS) mode.

No Sound

- Press the VOL+ and VOL- buttons to adjust the volume.
- Press the MUTE button on the remote control to cancel or restore the volume.
- If you have connected other equipment to the TV (such as a VCR or DVD Player), make sure the audio cables are connected securely between the TV and the other equipment.
- Check the SOUND settings. Details are on page 19 or 21.
- In case you hear wrong sound in S-Video or Video (CVBS) mode. Please check if you have connected the right sound signal to AV in (S-Video or Video input). Only one of the two video inputs can be connected to sound, but both video signals can be connected. This means that only one of the two sound inputs can be heard in S-Video and Video (CVBS) mode.

Remote Control does not work.

- Check the batteries. If necessary, replace them with two AAA heavy duty (zinc chloride) or alkaline batteries.
- Clean the remote control as well as the remote control sensor on the front of the TV.
- Check the TV power cord. Disconnect the power cord from the power outlet for 10 seconds, then reinsert the plug into the outlet. Press POWER to turn on the TV again.
- Make sure the outlet is not on a wall switch.
- Make sure a fuse has not blown at the power outlet.
- Always point the remote control toward the front of the TV (toward the remote sensor).
- Make sure that you use the supplied Magnavox Remote control, only the supplied Magnavox Remote control can be used with this LCD-TV set.

TV displays wrong channel or no channels.

- Repeat channel selection.
- Add the channel number(s) into the TV's memory. Use STORE. Details are on page 15.
- Make sure TUNER MODE is set correctly. Details are on page 15.
Then activate AUTO PROGRAM to set up all available channels. Details are on page 16.

**WARNING** concerning stationary images on the TV

Screen: Do not leave fixed images on the screen for extended periods of time. This can cause uneven aging of the LCD panel. Normal use of the TV should involve viewing of programs that have constantly moving or changing images. Do not leave onmoving images on screen for extended periods of time. Do not display the same images too frequently; if you do, subtle "ghost" images can be left on the LCD screen. Sources of stationary images may be Laser discs, video games, Compact Discs Interactive (CD-i), or paused Digital Video Discs (DVDs) or video tapes.

Here are some common examples of stationary images:

- DVD menus list DVD content.
- Letterbox black bars appear at the top and bottom of the TV screen when a wide screen (16:9) movie is viewed on a TV with standard (4:3) aspect ratio. This is available with some DVDs.
- Video game images and scoreboards
- Television station logos cause a problem if they are bright and stationary. Moving or low-contrast graphics are less likely to damage the picture tube.
- Stock market tickers may appear at the bottom of the TV screen if the TV programming covers this news.
- Shopping channel logos, pricing displays may be bright and may appear constantly during the show. These are usually in the same location on the TV screen.

TV Location

- To avoid cabinet warping, cabinet color changes, and an increased chance of TV failure, do not place the TV where temperatures can become excessively hot (for example, in direct sunlight or near a heating appliance).
- Allow a free flow of air around the TV.

Cleaning

- To avoid possible shock hazard, remove the TV's power cord from the electrical outlet before cleaning.
- Regularly dust the TV with a dry, non-scratching duster.
- When cleaning the TV, take care not to scratch or damage the screen surface. Avoid wearing jewelry or using anything abrasive. Do not use household cleaners. Wipe the screen with a clean cloth dampened with water. Use even, easy, vertical strokes when cleaning.
- Occasionally vacuum the vents on the rear of the TV.
- Never use thinners, insecticide sprays, or other chemicals on or near the cabinet. They may blemish the cabinet permanently.

A

| | |
|--------------------------|-----------|
| Antenna Connection | 4, 8 |
| Audio In jack | 10 |
| Auto Program | 4, 16, 24 |

B

| | |
|------------------|-----------|
| Balance | 4, 21, 30 |
| Bass | 4, 21, 30 |
| Batteries | 6 |
| Blocking | 25 |
| Brightness | 20, 29 |

C

| | |
|-----------------------------|-------|
| Cable Box Connections | 4, 9 |
| Cable TV Connection | 4, 8 |
| Care and Cleaning | 34 |
| Channel Edit | 4, 17 |
| Closed Captions | 4, 28 |
| Color | 20 |

F

| | |
|-----------------------------------|-----------|
| Factory Service | 4, 36, 37 |
| Factory Service Information | 36, 37 |
| Factory reset | 18 |

I

| | |
|-------------|-------|
| Index | 4, 35 |
|-------------|-------|

L

| | |
|------------------------|-------|
| Language | 4, 14 |
| Limited Warranty | 4, 38 |

M

| | |
|------------|-----------|
| Mono | 7, 21, 30 |
|------------|-----------|

P

| | |
|-------------------------------|-------|
| PC (Monitor) Connection | 4, 13 |
|-------------------------------|-------|

R

| | |
|------------------|----|
| Regulatory | 36 |
|------------------|----|

S

| | |
|--------------------------|----------------------|
| S-Video Connection | 11 |
| Sound | 4, 7, 19, 21, 30, 33 |
| Sound Mode | 19 |
| Stereo | 4, 7, 9, 21, 30 |

T

| | |
|----------------------------|-----------|
| Table of Contents | 4 |
| Tint | 20 |
| Treble | 4, 21, 30 |
| Troubleshooting | 33 |
| TV Operation (Basic) | 6 |

W

| | |
|----------------|-----------------|
| Warranty | 1, 2, 4, 36, 38 |
| Welcome | 4 |

MAGNAVOX LIMITED WARRANTY

Ninety (90) Days Labor & One (1) Year Parts & One (1) Year Display

MAGNAVOX warrants this product against defect in material or workmanship, subject to any conditions set forth as follows:

PROOF OF PURCHASE:

You must have proof of the date of purchase to receive warranted repair on the product. A sales receipt or other document showing the product and the date that you purchased the product as well as the authorized retailer included, is considered such proof.

COVERAGE:

(If this product is determined to be defective)

LABOR: For a period of ninety (90) days from the date of purchase, Magnavox will repair or replace the product, at its option, at no charge, or pay the labor charges to any Magnavox authorized service center. After the period of ninety (90) days, Magnavox will no longer be responsible for charges incurred.

PARTS: For a period of one (1) year, Magnavox will supply, at no charge, new or rebuilt replacement parts in exchange for defective parts. Magnavox authorized service centers will provide removal and installation of the parts under the specified labor warranty.

DISPLAY: For a period of one (1) year from the date of purchase, Magnavox will supply, at no charge, a new or rebuilt active display device in exchange for the defective display. Magnavox authorized service centers will provide removal and installation of the parts under the specified labor warranty. (PTV screens carry a thirty (30) day replacement warranty.)

EXCLUDED FROM WARRANTY COVERAGE

Your warranty does not cover:

- Labor charges for installation or setup of the product, adjustment of customer controls on the product, and installation or repair of antenna systems outside of the product.
- Product repair and/or part replacement because of improper installation, connections to improper voltage supply, abuse, neglect, misuse, accident, unauthorized repair or other cause not within the control of Magnavox.
- A product that requires modification or adaptation to enable it to operate in any country other than the country for which it was designed, manufactured, approved and/or authorized, or repair of products damaged by these modifications.
- Damage occurring to product during shipping when improperly packaged or cost of associated packaging.
- Product lost in shipment and no signature verification of receipt can be provided.
- A product used for commercial or institutional purposes (including but not limited to rental purposes).
- Products sold AS IS or RENEWED.

TO OBTAIN WARRANTY SERVICE IN THE U.S.A., PUERTO RICO, OR U.S. VIRGIN ISLANDS...

Contact Magnavox Customer Care Center at:
1-800-705-2000

TO OBTAIN WARRANTY SERVICE IN CANADA...

1-800-661-6162 (French Speaking)
1-800-705-2000 (English or Spanish Speaking)

REPAIR OR REPLACEMENT AS PROVIDED UNDER THIS WARRANTY IS THE EXCLUSIVE REMEDY FOR THE CONSUMER. MAGNAVOX SHALL NOT BE LIABLE FOR ANY INCIDENTAL OR CONSEQUENTIAL DAMAGES FOR BREACH OF ANY EXPRESS OR IMPLIED WARRANTY ON THIS PRODUCT. EXCEPT TO THE EXTENT PROHIBITED BY APPLICABLE LAW, ANY IMPLIED WARRANTY OF MERCHANTABILITY OR FITNESS FOR A PARTICULAR PURPOSE ON THIS PRODUCT IS LIMITED IN DURATION TO THE DURATION OF THIS WARRANTY.

Some states do not allow the exclusions or limitation of incidental or consequential damages, or allow limitations on how long an implied warranty lasts, so the above limitations or exclusions may not apply to you. In addition, if you enter into a service contract agreement with the MAGNAVOX partnership within ninety (90) days of the date of sale, the limitation on how long an implied warranty lasts does not apply.

This warranty gives you specific legal rights. You may have other rights which vary from state/province to state/province.

Magnavox, P.O. Box 671539, Marietta, GA. 30006-0026

(Warranty: 4835 710 28125)

Free Manuals Download Website

<http://myh66.com>

<http://usermanuals.us>

<http://www.somanuals.com>

<http://www.4manuals.cc>

<http://www.manual-lib.com>

<http://www.404manual.com>

<http://www.luxmanual.com>

<http://aubethermostatmanual.com>

Golf course search by state

<http://golfingnear.com>

Email search by domain

<http://emailbydomain.com>

Auto manuals search

<http://auto.somanuals.com>

TV manuals search

<http://tv.somanuals.com>