

OWNER'S MANUAL

LCD TV Monitor
20MF200V

MAGNAVOX
SMART . VERY SMART .

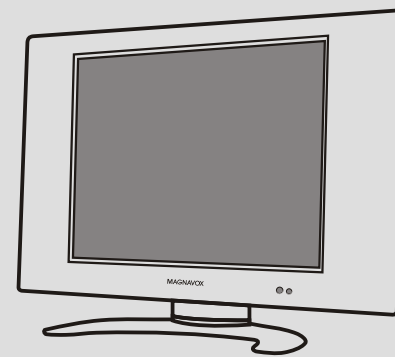

NEED HELP? CALL US!

MAGNAVOX REPRESENTATIVES ARE READY TO HELP YOU WITH ANY QUESTIONS ABOUT YOUR NEW PRODUCT. WE CAN GUIDE YOU THROUGH CONNECTS, FIRST-TIME SETUP, AND ANY OF THE FEATURES. WE WANT YOU TO START ENJOYING YOUR NEW PRODUCT RIGHT AWAY.

CALL US BEFORE YOU CONSIDER RETURNING THE PRODUCT.
1-800-705-200



OR VISIT US ON THE WEB AT WWW.MAGNAVOX.COM

Important!
Return your **Warranty Registration Card** within 10 days.
See Why Inside.

Table of Contents

Important Safety Instructions.....	3
FCC Statement	5
Precautions and Reminders	6
Wall Mount	8
Specifications	9
Front and Rear Panel	10
Quick Connecting Guide	12
PC Connection	14
Remote Control Function	15
OSD Menu Descriptions	16
OSD Function (PC picture controls)	23
Troubleshooting	25
Warranty Information	26

Important Safety Instructions

	Caution Risk of electronic shock Do not open	
CAUTION: TO REDUCE THE RISK OF ELECTRIC SHOCK. DO NOT REMOVE COVER (OR BACK). NO USER SERVICEABLE PARTS INSIDE.		
REFER SERVICING TO QUALIFIED SERVICE PERSONNEL.		



The lightning flash with arrowhead symbol. Within an equilateral triangle. is intended to alert the presence of uninsulated "dangerous voltage" within the product's enclosure that may be of a sufficient magnitude to constitute a risk of electric shock to persons.



The exclamation point within an equilateral triangle. is intended to alert the user to the presence of important operating and maintenance (servicing) instructions in the literature accompanying the appliance.

Caution

1. Read these instructions.
2. Keep these instructions.
3. Heed all warnings and follow all instructions.
4. Please use this product within operating temperature 5 C ~ 40 C, relative humidity 20 ~ 80%.
5. Clean only with a damp cloth.
6. Do not block any of the ventilation openings. Install in accordance with the manufacturers instructions.
7. Do not install near any heat source such as radiators, heat registers, stoves or other apparatus that produce heat.
8. Do not defeat the safety purpose of the polarized or grounding type plug. A polarized plug has type blades with one wider than the other. A grounding - type plug has two blades and a third grounding prong. The wide blade or third prong are provide for your safety. When the provided plug does not fit into your outlet, consult an electrician for replacement of the obsolete outlet.
9. Protect the power cord from being walked on or pinched particularly at plugs, convenience receptacles, and the point where they exit from the apparatus.
10. Only use attachment/accessories specified by the manufacturer.
11. Use only with a cart, stand, tripod, bracket or table specified by the manufacturer, or sold with the apparatus.
When a cart is used, use caution when moving the cart/apparatus combination to avoid injury from tip-over.



Important Safety Instructions

12. Unplug this apparatus during lightning storms or when unused for long periods of time.
13. Refer all servicing to qualified service personal.
Servicing is required when the apparatus has been damaged in any way, such as power supply cord or plug is damaged, liquid has been spilled or objects have fallen into the apparatus, the apparatus has been exposed to rain or moisture, does not operate normally, or have been dropped.
14. Apparatus shall not be exposed to dripping or splashing and no objects filled with liquids, such as vases, shall be placed on the apparatus.
15. Unplug the unit and inform the service center in case of abnormalities seen with regards to the operation of the unit.
16. Use soft dry cloth for cleaning the cabinet/screen of the television.
DON'T USE ALCOHOL/ACETONE in cleaning the unit.
17. Always use the POWER BUTTONS on the unit or remote control when turning off in order to prolong lamp life.
18. Contact service center if the picture displayed by the unit is getting dimmer.
19. Don't place the unit on an uneven surface. Make sure it has a 15cm space from the wall.
20. Keep unit away from direct sunlight.
21. Don't step or put heavy materials on top of the unit.
22. Make sure to unplug the unit when there are no people left in the house for a long period of time (days).
23. Do not install this equipment in a confined space such as a book case or similar unit

This product satisfies FCC regulations when shielded cables and connectors are used to connect the unit to other equipment.

Prevent electromagnetic interference with electric appliances such as radios and televisions, use shielded cables and connectors for connections.

Warning

FCC Regulations state that any unauthorized changes or modifications to this equipment not expressly approved by the manufacturer could void the user's authority to operate this equipment.

FCC Statement

FCC notice

This equipment has been tested and found to comply with the limits for a Class B digital device, pursuant to part 15 of the FCC Rules.

These limits are designed to provide reasonable protection against harmful interference in a residential installation. This equipment generates, uses and can radiate radio frequency energy and, if not installed and used in accordance with the instructions, may cause harmful interference to radio communications. However, there is no guarantee that interference will not occur in a particular installation. If this equipment does cause harmful interference to radio or television reception, which can be determined by turning the equipment off and on, the user is encouraged to try to correct the interference by one or more of the following measures:

- 1.Reorient or relocate the receiving antenna.
- 2.Increase the separation between the equipment and receiver.
- 3.Connect the equipment into an outlet on a circuit different from that to which the receiver is connected.
- 4.Consult the dealer or an experienced radio/TV technician for help.

Modifications not expressly approved by the manufacturer could void the user's authority to operated the equipment under FCC rules. This device complies with part 15 of the FCC Rules.

Operation is subject to the following two conditions:

- 1.This device may not cause harmful interference, and
- 2.This device must accept any interference received, including interference that may cause undesired operation.

Precautions And Reminders

Place unit on even surfaces.

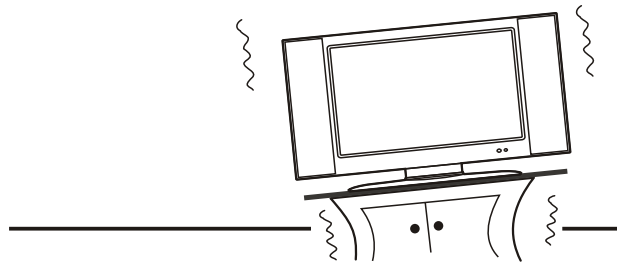

Don't place the TV in a box when using it.

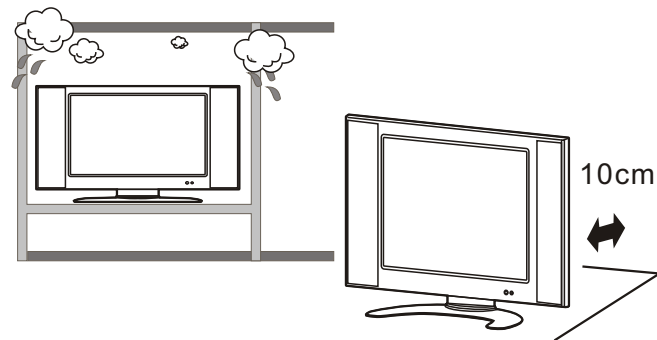

Unplug immediately if there is malfunction like no picture, no video/audio, smoke, bad odor from TV..

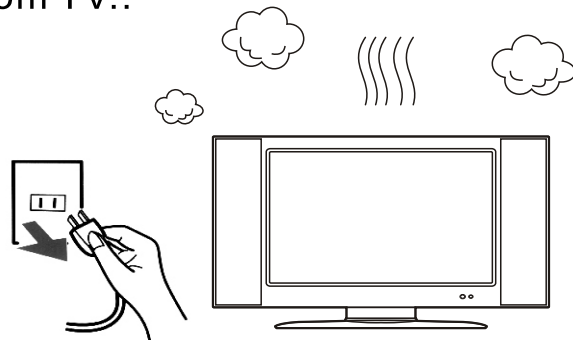

Unplug immediately if other foreign materials are put inside TV box or if the TV fell down.

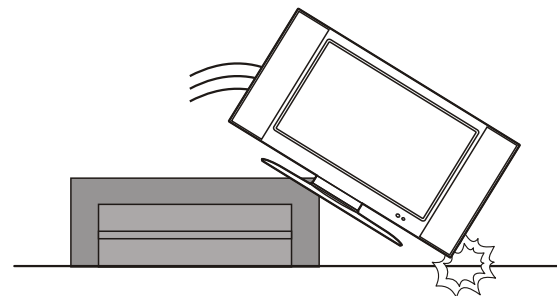

Don't throw any object inside the TV box like metals or other flammable materials.

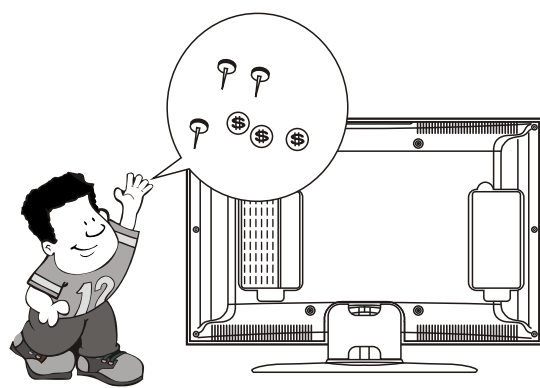

Prohibit/Avoid opening the TV box

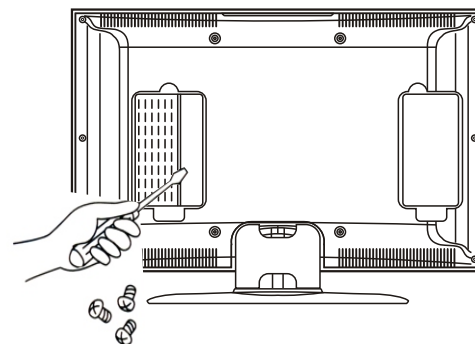

Precautions And Reminders

Remember to unplug the AC cord from the AC outlet before cleaning the display unit. Do not use liquid cleaners or aerosol cleaners to clean the display.

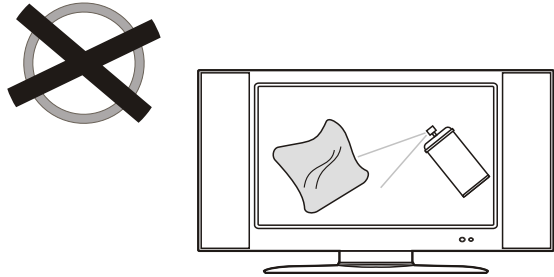

Avoid direct sunlight contact to TV. Avoid dusty, high humidity and smoky areas.

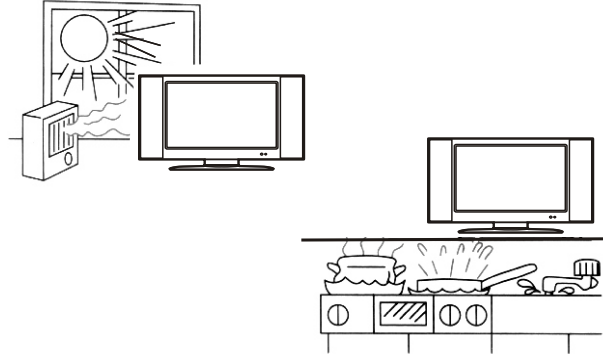

Make sure to unplug the unit when there are no people left in the house for a long period of time (days).

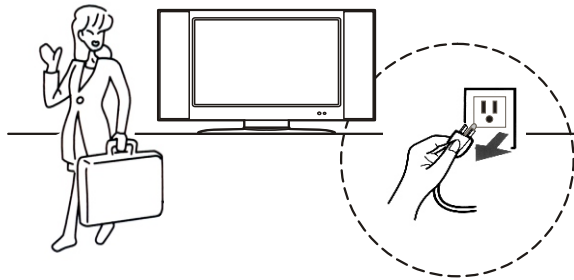

Call service personnel in cleaning the internal part of the TV box once a year.

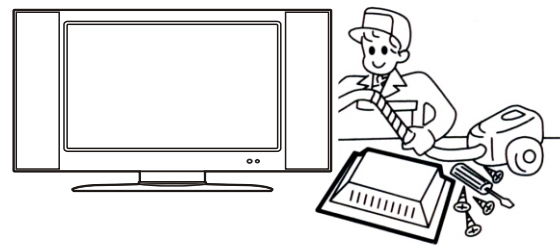

Do not cover or block these vents and openings, because inadequate ventilation may shorten the life of the display unit and cause overheating.

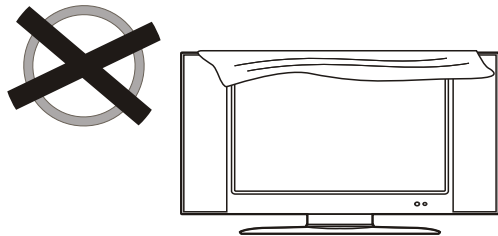

Do not place the display near water. Like bathtub, washbasin, kitchen sink laundry tub, swimming pool or in a damp basement.



Notice for Remote Controller

Avoid Dropping



Avoid Soaking



Avoid Aerosol Cleaners



Wall Mount

The wall mount set (Optional)

Contact a professional installer if you are unsure about wall mount installation, as unskilled installation may cause injury and may damage to the display unit.

Caution: In order not to damage the display unit during disassembling the unit stand, place the display panel on a soft fabric (i.e., a blanket) and face down.

Adjust View Angle (Wall Mount)

Use standard VESA mounting for wall mount.
Please mount this product solidly on the wall or pole.

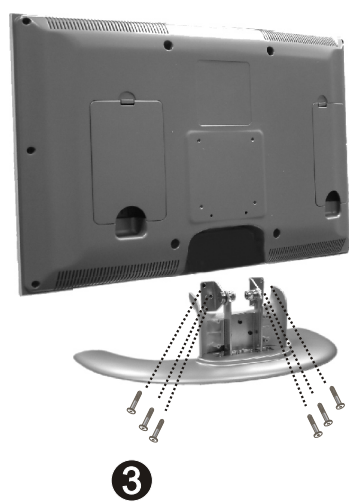

1. Take off Cable Cover.
2. Loosen screws on back cover, and take off..
3. Loosen screws on stand, and dismantle it.
4. Install wall mount.

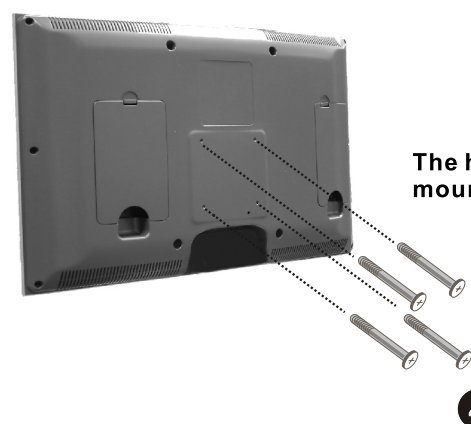
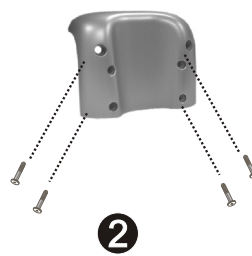

The holes for VESA mounting (Total 4 holes)

Specifications

LCD Panel	
Screen Size	20.1 Inch, 50cm
Display Type	TFT LCD (Active Matrix)
Resolution	800x600xRGB
Colors	16.7 Million colors
View Angle	Horizontal 160°, Vertical 120°, CR≥10
Dot Pitch	0.51 mm
Brightness	500 cd/m ²
Contrast Ratio	500:1
Aspect Ratio	4:3
Response Time	16 ms (gray to gray)
Lamp Life	6xCCFL backlight Lamps w/50,000hrs
VGA	
VGA Resolution	Support 640x480, 800x600
VGA Input	analog, 15-pin mini D-SUB female connector
Vertical Frequency	56 Hz~75 Hz
Horizontal Frequency	30 kHz~48 kHz
TV	
TV Channels	Air and cable TV
Video Audio	
Video Input Format	NTSC / PAL (auto detected), SECAM
Video Input	Video 1 : Composite Video / S-Videox1, S-Video priority Video 2 : Composite Video Video 3 : Component in (YCbCr 480i, 576i)
Audio Input	R / Lx4 (CVBS, S-Video)x1, Video 2x1, Componentx1, Pc x1
Audio Output	Speaker R / Lx1 (3Wx2). Volume, bass, Treble adjustable Mute Control. Sound effect included
Headphone	Build-in, Stereo
Others	
Accessories	Remote Controlx1, AC power cordx1, Manualx1, AV cable, Wall mount
OSD	English / Spanish / French
Safety / EMI	UL / FCC Part 15 Class B
Power Source	100-240V AC, 50 / 60 Hz, DC 12V, 5A
Power Consumption	60 W (Max) / 1.5W (Stand By)

Front And Rear Panel

Front panel

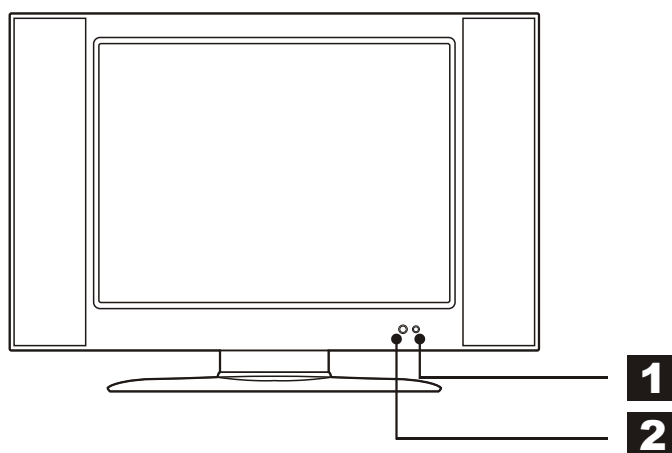

Function panel

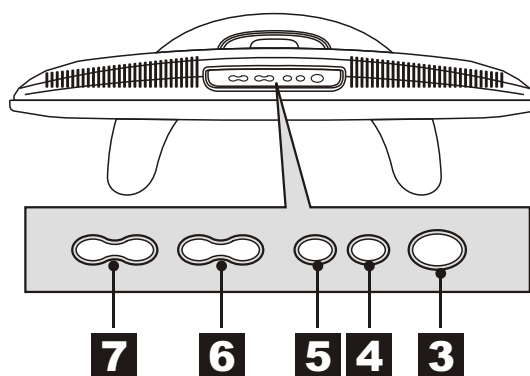

- 1 Power Indicator:**
Stand by mode displays red. Power on displays green.
- 2 IR Receiver:**
Aim the IR receiver window when using Remote Controller.
- 3 Power key:**
Press once to turn on. Press again to return stand by mode.
- 4 TV / Video key:**
Select signal source, following by
TV → AV 1 / S-VIDEO → AV 2 → COMPONENT → PC mode circle.
- 5 Menu key:**
Press to display the Menu. Also press to exit the Menu.
- 6 Volume Control / Setting keys:**
Press " - " to decrease volume, and press " + " to increase volume. When OSD menu displays, these two keys enable to set each selection of menu.
- 7 Channels / Cursor Up/Down key :**
Press " - " to select channels from high to low, and press " + " to select channels from low to high. When OSD menu displays, these two keys enable to select each setting.

Front And Rear Panel

Rear Panel

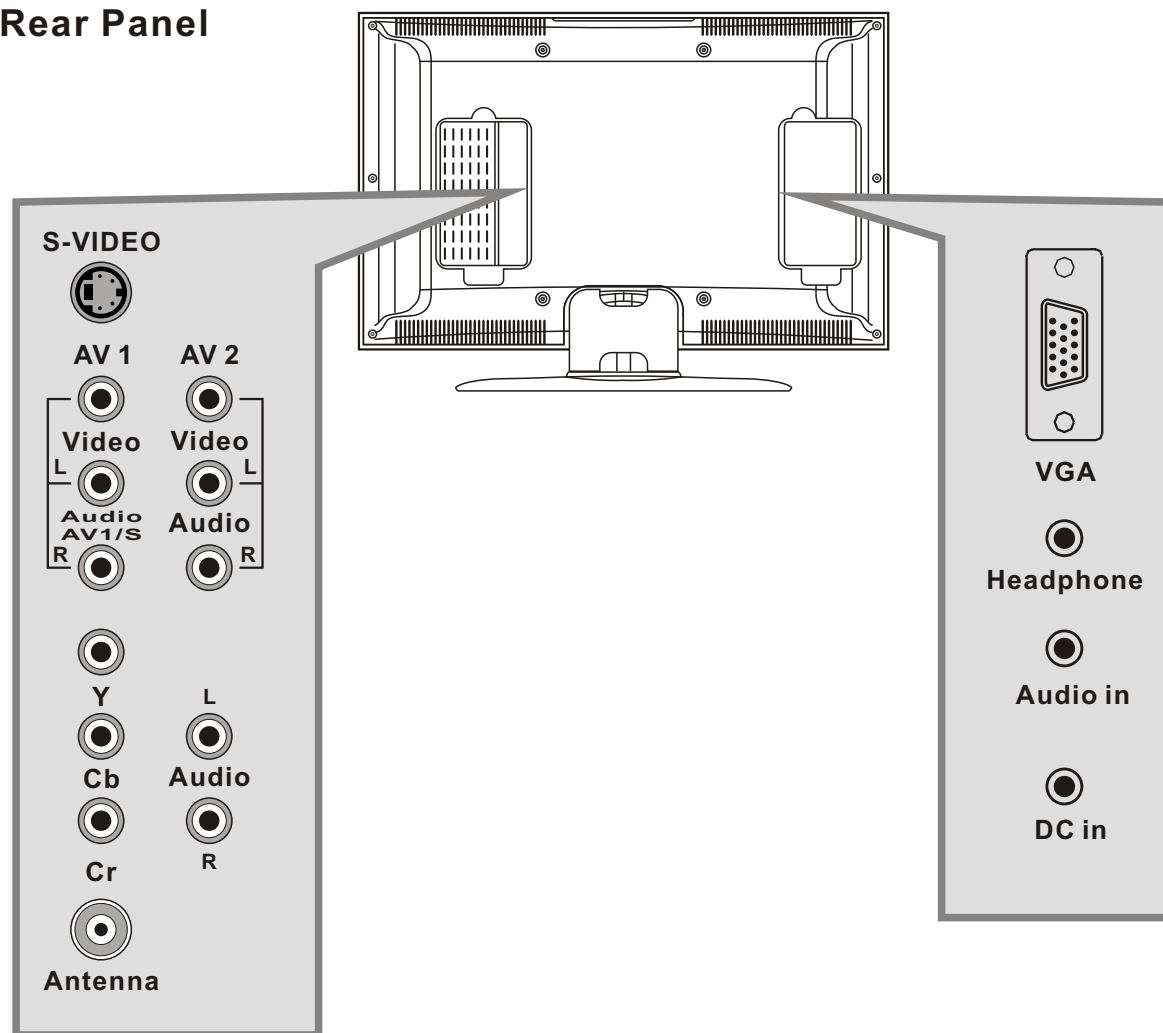

ANT Input Socket : 75 Ω F type coaxial cable connector.

Y Cb Cr Input Socket : Connecting with other component output included appliance.

AV 1 Socket : Connecting with DVD player or VCR AV output.

S-VIDEO Input Socket : Connecting with other S-VIDEO output included appliance.

AV 2 Input Socket : Connecting with DVD player or VCR AV output.

VGA Input Socket : Connecting with VGA input socket of PC to display monitor.

Headphone Socket

PC Audio Input Socket : Connecting with Line Out socket of PC.

Quick Connecting Guide

This product includes AV, S-VIDEO, COMPONENT input sockets to connect with DVD player, VCR, DV Cam to obtain better picture quality.

When both Av1 and S-Video input are connected (Internal Auto-detect), S-VIDEO is priority to be applied.

All input sockets need to select proper sources to work.

Video and Audio is specified with standard colors.
Please follow the colors to connect:

Video.....Yellow (Y)
Audio (L)..White (W)
Audio (R)..Red (R)
Y.....Green
Cb.....Blue
Cr.....Red

Connection Instruction

1. Connect preferred home entertainment appliances with AV1 / S-VIDEO / AV2 / COMPONENT / PC input sockets.
2. Press Source key to select following: AV1/S-VIDEO → AV2 → COMPONENT



Connecting DVD Player / VCR

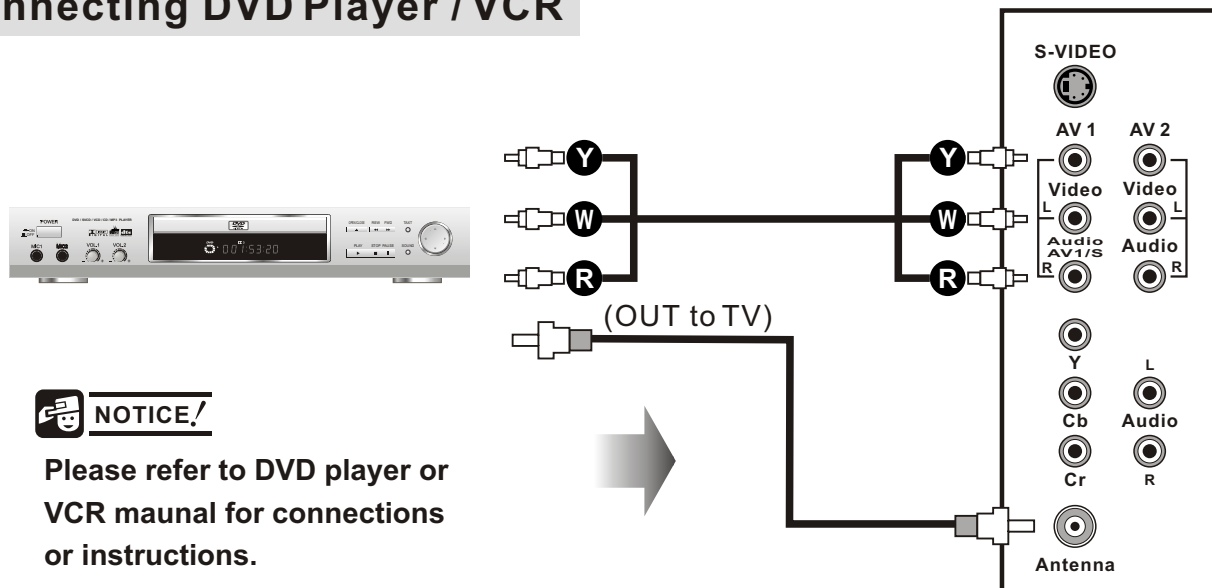

Quick Connecting Guide

Using COMPONENT Input for DVD Player and Av2 for VCR

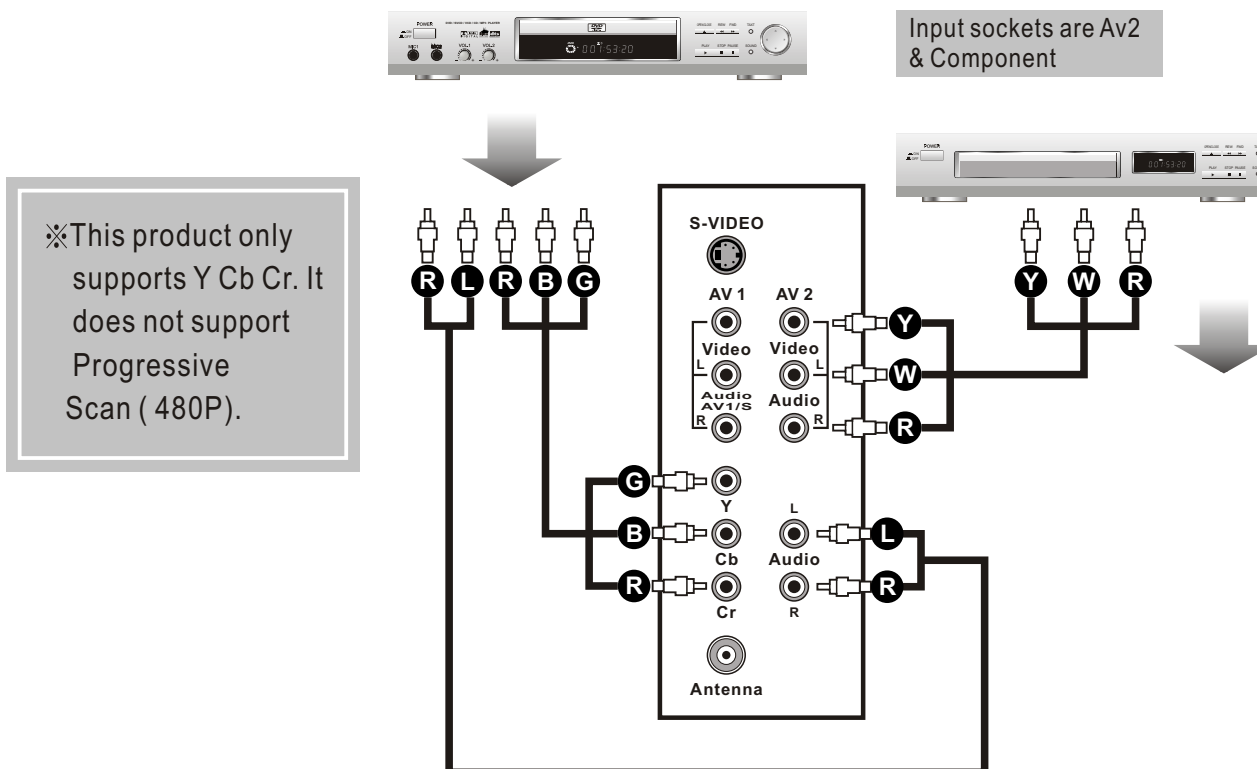

Using S-VIDEO for DVD Player / VCR

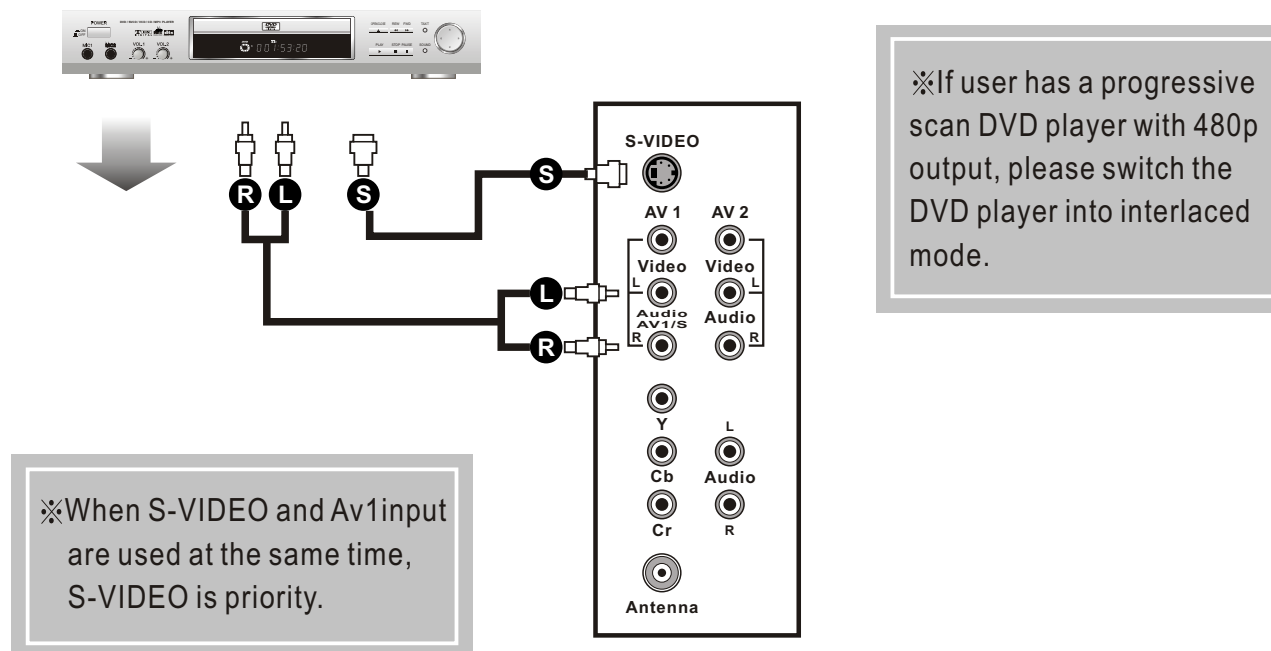

PC Connection

Connecting PC Instructions

1. Video Signal Connection:
Connect VGA signal cable to VGA input socket and VGA output of the graphic card on the computer.
2. Audio Signal Connection:
Connect audio signal cable to AUDIO IN socket and LINE OUT plug on the computer.

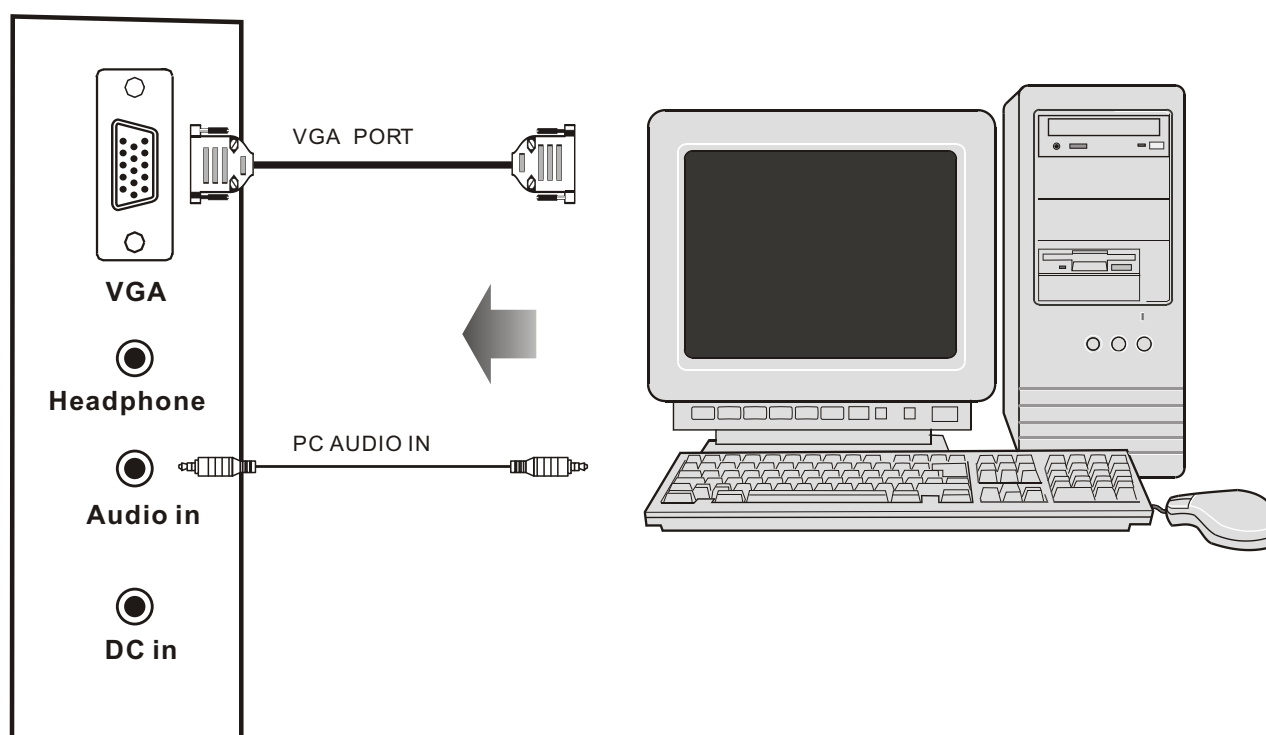

Operating Instructions

1. Turn on the power of this product.
2. Press Source key to select PC mode.
3. Turn on computer, and screen will display.

- When user switches to a resolution not listed, screen at right will display **OUT OF RANGE**. Please wait for while, as computer will return back to previous resolution.
- When PC/VGA signal loses, power indicator will display red and green colors flash in waiting condition. User can switch to other source or return to computer to support VGA signal again.

MODE	Resolution	Refresh Rate
VGA	640x480	60
	640x480	72
	640x480	75
SVGA	800x600	60
	800x600	72
	800x600	75

Remote Control Functions

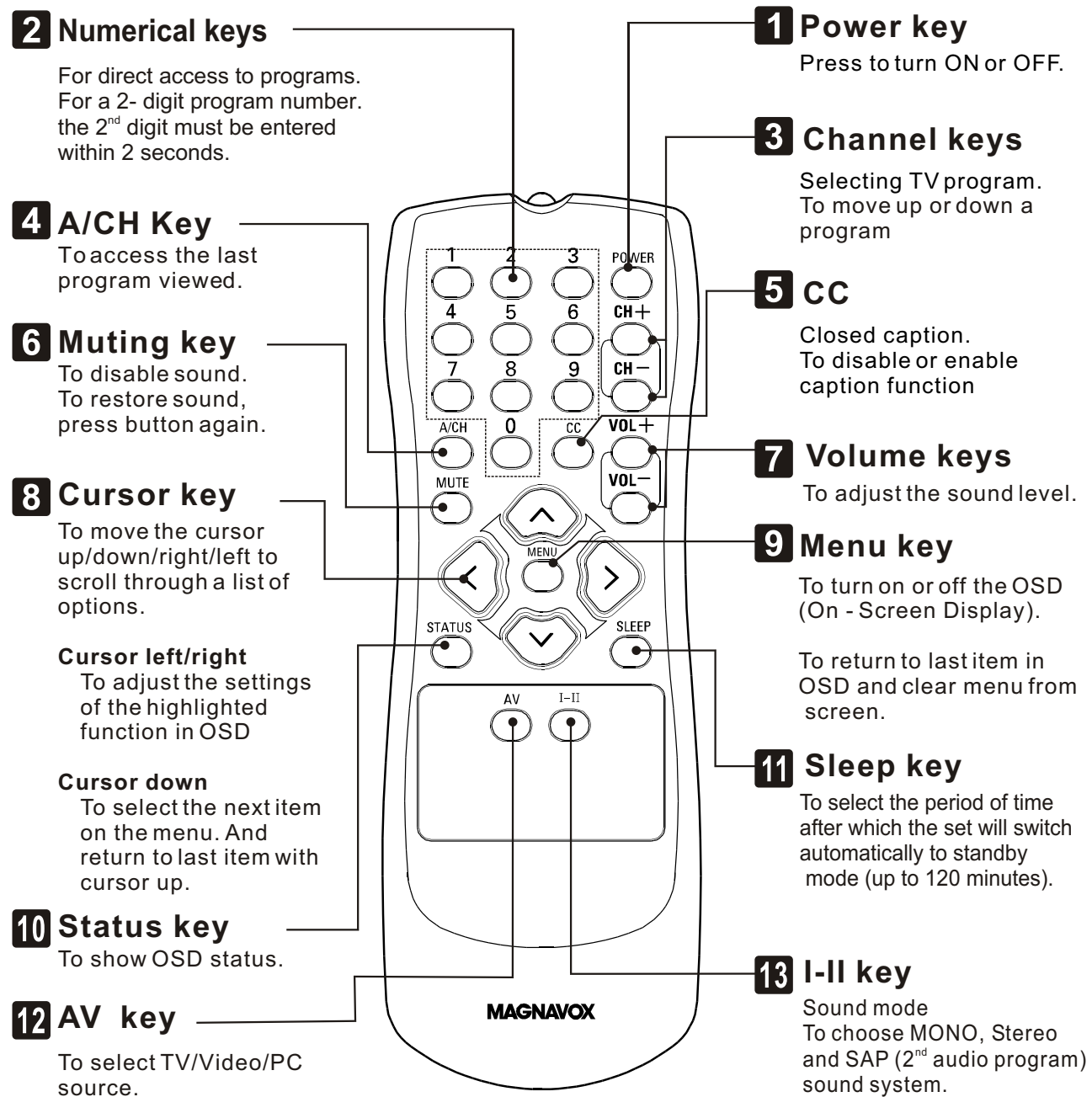

OSD Menu Descriptions

Menu Instruction:

Press Menu key on front or remote controller
On the OSD menu, the INSTALLATION, PICTURE, AUDIO and SETUP sections can be adjusted

Active sections display Yellow. Adjustable sections display Green. Inactive sections display Gray. Selected section displays Red.

1. Press Cursor Up/Down key to select section.
2. Press Cursor Left/Right keys to adjust sections.
3. Follow the info on screen to adjust.

Once setting is finish, please press Menu key to exit, and follow above instruction to adjust other settings.

OSD will disappear automatically if no key is pressed.

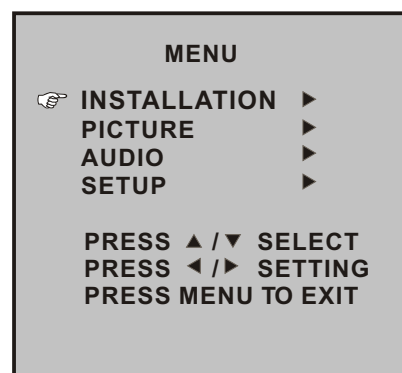

INSTALLATION

TV Setting, adjustable settings as right figure:



OSD Menu Descriptions

CHANNELS ADD / SKIP

After running **AUTO PROGRAM**, use following steps to add or delete channels.

1. ADD: Press number or Cursor Up/Down key to select channel, and press Cursor Left/Right key to add.

2. SKIP: Press number or Cursor Up/Down key to select channel, and press Cursor Left/Right key to erase.



AUTO PROGRAM

This product memorizes channels automatically after running **AUTO PROGRAM**. Once memorized, use remote controller or front keys to select channels.

To turn on **AUTO PROGRAM** function, press Cursor Left/Right key to operate.



CHANNEL MODE

To select **CATV** or **AIR** mode, press Cursor Left/Right key to change.

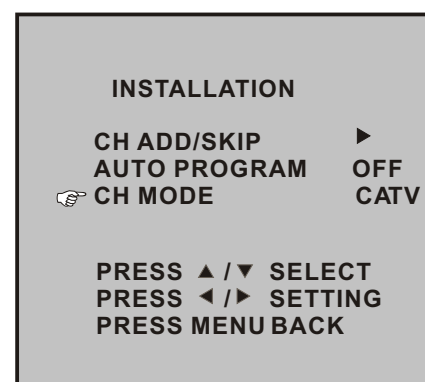

OSD Menu Descriptions

PICTURE SETTING

Please refer to below figure, and adjust with preferred settings.

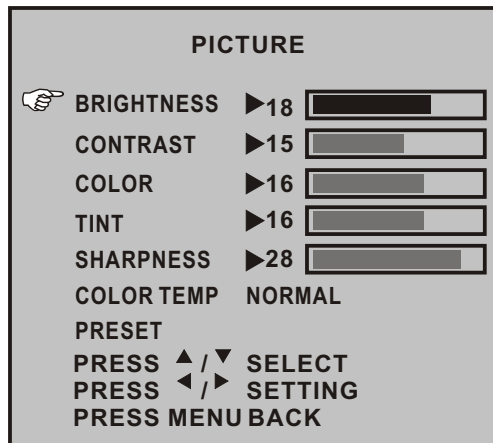

BRIGHTNESS : Brighter or darken the picture.

CONTRAST : Deepen or soften the picture.

COLOR : Adjust picture color intensity.

TINT : Adjust picture color tint.

SHARPNESS : Sharpen or soften the picture.

COLOR TEMP : Adjust picture color following by :

→ NORMAL / COOL / WARM ←

PRESET : Back to default setting.

AUDIO SETTING

Please refer to below figure, and adjust with preferred settings.

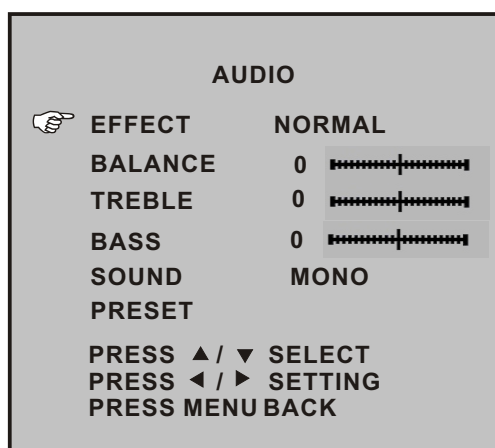

EFFECT: NORMAL / SURROUND two mode.
 TREBLE and BASS are adjustable on NORMAL mode only.

BALANCE: Default 0 is centralized and balanced.
 When number is increased, right speaker performs stronger.
 When number is decreased, left speaker performs stronger.

TREBLE: When number is increased, treble performs stronger.
 When number is decreased, treble performs weaker.

BASS: When number is increased, bass performs stronger.
 When number is decreased, bass performs weaker.

SOUND: To select sound mode, press Cursor Left/Right keys to change.
 I-II key on remote controller is the same function.

→ STEREO / SAP / MONO ←

※Bilingual mode is only activated when program contains stereo and SAP (Second Audio Program).

※When MONO is selected, any sound source would be MONO even it is stereo broadcasting.

OSD Menu Descriptions

SETUP

Please refer to below figure, and adjust with preferred settings.

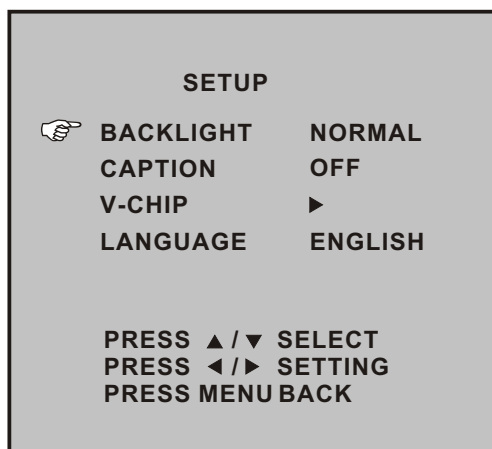

BACKLIGHT: Adjust backlight brightness following by:

→ NORMAL / BRIGHTEN / DARKEN ←

LANGUAGE: English / Spanish / French selectable.

CLOSED CAPTION

Allow user to select from three closed modes as below:

Off: Turn off Caption Vision.

CC1/ CC2 : Displays a printed version of the dialog or sound effects of a program.
CC1 should be set for most programs.

CC MUTE: Mute the sound but still display caption. The CC MUTE option can be used to set the TV to turn the CLOSE CAPTION mode ON whenever the MUTE button is pressed.

To activate closed caption function, you can :

1. Press CC Key on remote controller.
2. Press Cursor Up/Down key to select the Caption option of TV setting. The closed caption selection as following:

→ OFF / CC1 / CC2 / CC-MUTE ←

Not all broadcasting programs support Closed Caption.

OSD Menu Descriptions

V-CHIP

Understanding V-Chip

The V-Chip feature receives and processes the data that contains program content advice sent by the broadcasters or other program providers. When programmed by the viewer, a TV with V-Chip can respond to the content advice and block any program content that may be considered unsuitable (such as offensive language, violence, sexual situations, etc.). This is a great feature for censoring the type of programs children watch.

In the V-Chip section you'll learn how to block channels and programs that are not rated, are unrated, or have no rating. You will also find out how to turn these blocking features ON or OFF. Below brief explanations are given of some terms and ratings relate to the V-Chip feature.

You can block individual channels or block programs on the basis of the ratings of the MPAA and TV broadcasters.

Movie Ratings (Motion Picture Association of America)

G: General Audience

All ages admitted. Most parents would find these programs suitable for all ages. This type of program contains little or no violence, no strong language and little or no sexual dialogue or sexual situations.

PG: Parental Guidance Suggested

These types of programs contain material that parents may find unsuitable for younger children. It may contain one or more of the following: moderate violence, some sexual situations, infrequent coarse language, or some suggestive dialog.

PG13: Parents Strongly Cautioned

These types of programs contain material that parents may find unsuitable for children under the age of 13. It contains one or more of the following: violence, sexual situations, coarse language, or suggestive dialog.

R: Restricted

This type of program has been designed specifically for adults. Anyone under the age of consent should view these programs only with an accompanying parent or adult guardian. They will contain one or more of the following: intense violence, explicit sexual situations, strong or coarse language, or intensely suggestive dialogue.

Nc17

No one under the age 17 will be admitted. These types of programs should be viewed by adults only. They will contain graphic violence, explicit sex, or crude, indecent language.

X: Adults Only

These types of programs contain one or more of the following: very graphic violence, very graphic and explicit or indecent sexual activity, very coarse and intensely suggestive language. This is used to rate TV programming. There are two parts in this rating system: an age-base ratings that indicates the age group for particular designed program, and a content-base ratings to details if the program contains higher levels of sex, violence or adult language.

OSD Menu Descriptions

V-CHIP SETTING

The options in V-CHIP setting include:

MOVIE RATING
TV RATING
PASSWORD
V-CHIP

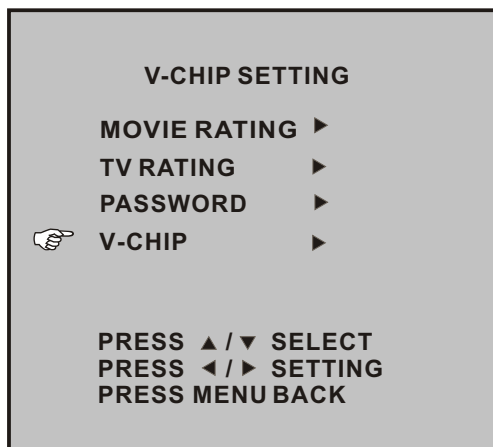

Select to V-CHIP and press Cursor Left/Right key to enable V-CHIP function.

For the first time to use V-CHIP-setting, entering default password [1111] is required.

MOVIE RATING SETTING

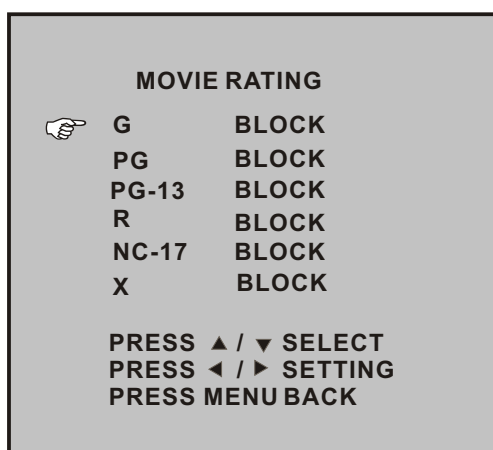

Press Cursor Up/Down key and Cursor Left/Right keys to block or unblock each rating.

When the rating is blocked, higher ratings for older ages will be blocked automatically.

Ex. When R is blocked, NC-17 and X ratings will also be blocked automatically.

OSD Menu Descriptions

TV RATING SETTING

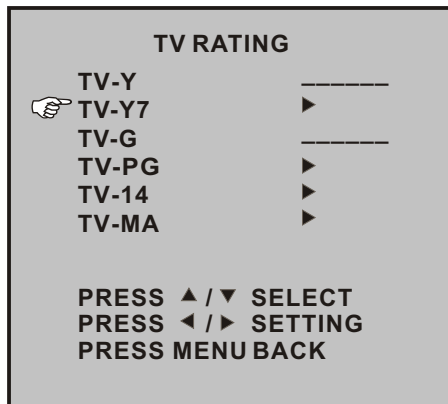

To adjust TV ratings, press Cursor Up/Down and Left/Right key to select and adjust.

V - CHIP SETTING

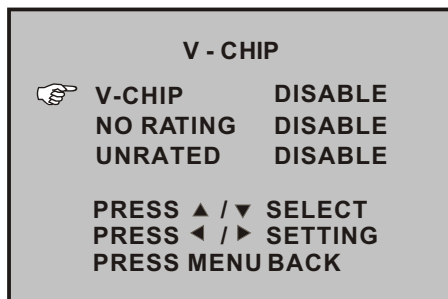

V-CHIP : When DISABLE, UNRATED and NO RATING is not activated.

NO RATING : When ENABLE, the program will be blocked automatically if no V - CHIP data receipt.

UNRATED : When ENABLE, the program will be blocked automatically if program is unrated.

PASSWORD SETTING

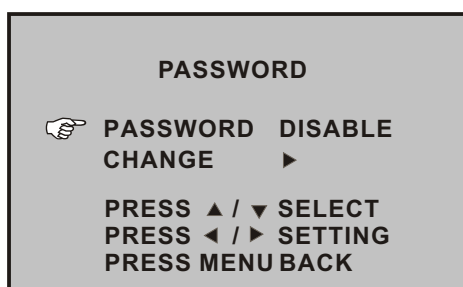

Press Cursor Left/Right keys to enable or disable Password function.

To change password, please select CHANGE and input new password as the left bottom figure.

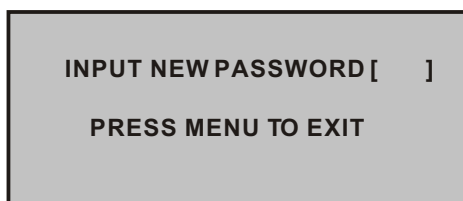

If password function is disabled, there is no need to input password when using V-Chip function.

If password is forgotten, please do the following steps:

1. Enter code [2567], INCORRECT PASSWORD blinking on the screen.
2. Enter code [2567] again, V-Chip Setting menu will appear on the screen.

OSD Function (PC Picture Controls)

1. Press front Menu key to display OSD menu.
2. Press Cursor Up/Down key to select Screen Adjust, Picture Adjust, Audio Adjust and OSD Adjust.
3. Press Cursor Left/Right keys to adjust sub-items.

Active sections display Yellow. Adjustable sections display Green. Inactive sections display Gray. Selected section displays Red.

Screen Adjust

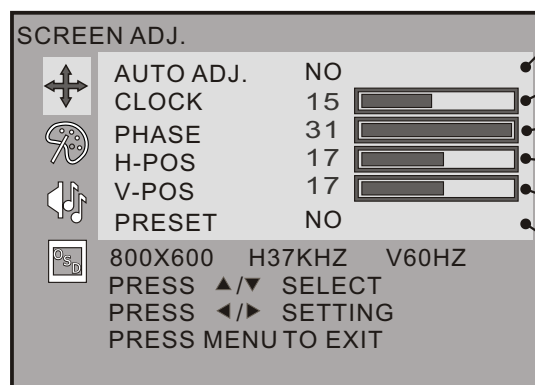

- Adjust the best position and display on the screen automatically.
- Adjust pixel clock.
- Adjust phase.
- Adjust horizontal display position.
- Adjust vertical display position.
- Recall Default Settings.

Picture Adjust

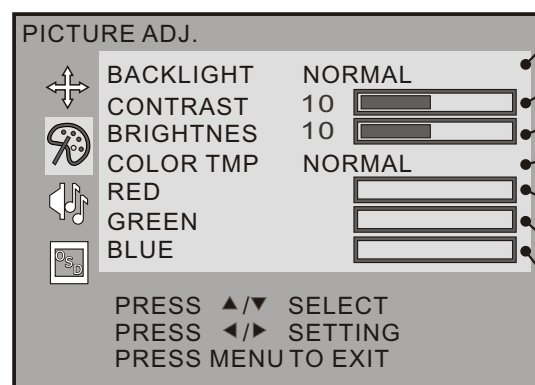

- Adjust backlight brightness following by:
- Adjust contrast ratio
- Adjust brightness
- Adjust color temperature following by:
- Longer bar displays picture more reddish, and shorter is less reddish.
- Longer bar displays picture more greenish, and shorter is less greenish.
- Longer bar displays picture more bluish, and shorter is less bluish.
- These three settings are only activated when COLOR TEMP selects USER setting.

OSD Function (PC Picture Controls)

Audio Adjust

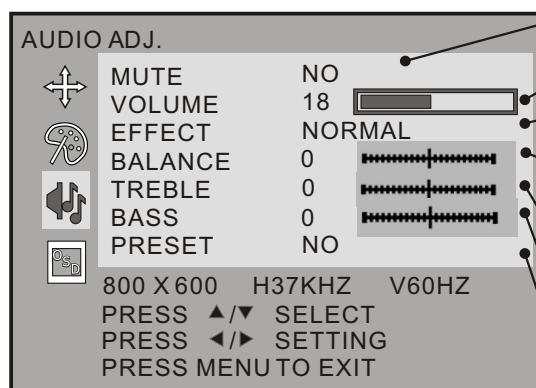

- Turn ON to mute the sound.
- Adjust volume. Longer bar represents louder sound.
- NORMAL / SURROUND two mode when AX Box is connected. (TREBLE and BASS are adjustable on NORMAL mode only.)
- Default 0 is centralized and balanced.
- When number is increased, right speaker performs stronger.
- When number is decreased, left speaker performs stronger.
- When number is increased, treble performs stronger.
- When number is decreased, treble performs weaker.
- When number is increased, bass performs stronger.
- When number is decreased, bass performs weaker.
- Recall Default Settings.

Note: Effect, Balance, Treble, Bass and Preset settings will be activated when AV Box is combined.

OSD Adjust



- The same function as press Menu key to exit.
- Adjust screen horizontal position.
- Adjust screen vertical position.
- Adjust the time of OSD Menu display on the screen. Per second as unit, Maximum is 30 seconds, and minimum is 3 seconds.
- LANGUAGE: English / Spanish / French selectable.

Troubleshooting

Troubleshooting

Symptoms	Checks
No Picture and Sound	<ul style="list-style-type: none"> ● Check power cord ● Check if in stand-by mode ● Check the connections and source
Noise from Cabinet	<ul style="list-style-type: none"> ● Due to outer temperature change. Please note this does not affect the performance of this product.
Interference	<ul style="list-style-type: none"> ● Electrical appliances, Cars / Motorcycles or Fluorescent lights interference
Poor or Distorted Picture	<ul style="list-style-type: none"> ● Check antenna connection
Playing Stereo but receiving Mono	<ul style="list-style-type: none"> ● Check OSD if Audio is selected Mono
No Color	<ul style="list-style-type: none"> ● Adjust Picture Setting
No Sound	<ul style="list-style-type: none"> ● Try to adjust volume ● Headphone jack is using ● Video and Audio plugs connect different sources ● Mute function is activated
Snowy Picture	<ul style="list-style-type: none"> ● Adjust antenna location or connection
Multiple Picture	<ul style="list-style-type: none"> ● Adjust antenna location or connection
No power	<ul style="list-style-type: none"> ● Check Power Cord
Remote Controller not working	<ul style="list-style-type: none"> ● Check batteries ● Aim remote controller to IR receiver
No picture when playing DVD	<ul style="list-style-type: none"> ● If DVD player supports progressive scan, switch the DVD player into interlaced mode.

MAGNAVOX LIMITED WARRANTY

Ninety (90) Days Free Product Exchange

MAGNAVOX warrants this product against defect in material or workmanship, subject to any conditions set forth as follows:

PROOF OF PURCHASE:

You must have proof of the date of purchase to exchange the product. A sales receipt or other document showing the product and the date that you purchased the product as well as the authorized retailer included, is considered such proof.

COVERAGE:

Warranty coverage begins the day you buy the product. For a period of ninety (90) days from the date of purchase, if the product is determined to be defective, Magnavox will exchange the defective product with a new or renewed product, at its option, at no charge. The replacement product is covered only for the warranty period of the original product. When the warranty on the original product expires, the warranty on all replaced products also expires. When it is necessary for you to ship the product to Magnavox for exchange, you will pay the shipping cost for shipment to Magnavox. Magnavox will pay the shipping costs when returning a product to you.

Note: The exchange model supplied will be the most comparable one in Magnavox current inventory. Shipping of your product to Magnavox implies intent to follow the specified requirements of the warranty and exchange program. Product received by Magnavox cannot be returned. Replacement product can only be sent if all warranty requirements are met. Failure to follow all requirements can result in delay of exchange process.

EXCLUDED FROM WARRANTY COVERAGE

Your warranty does not cover:

- Shipping charges to return defective product.
- Labor charges for installation or setup of the product, adjustment of customer controls on the product, and installation or repair of antenna systems outside of the product.
- Product repair and/or part replacement because of improper installation, connections to improper voltage supply, abuse, neglect, misuse, accident, unauthorized repair or other cause not within the control of Magnavox.
- A product that requires modification or adaptation to enable it to operate in any country other than the country for which it was designed, manufactured, approved and/or authorized, or repair of products damaged by these modifications.
- Damage occurring to product during shipping when improperly packaged or cost associated with packaging.
- Product lost in shipment and no signature verification of receipt can be provided.
- A product used for commercial or institutional purposes (including but not limited to rental purposes).
- Product sold AS IS or RENEWED.

WHERE WARRANTY EXCHANGE IS AVAILABLE:

Exchange is available in all countries where Magnavox officially distributes the product. In countries where Magnavox does not distribute the product, the local Magnavox organization will attempt to exchange the product, although there may be a delay if the appropriate product is not readily available or special customs processes are implied.

FOR EXCHANGE IN THE U.S.A., PUERTO RICO, OR U.S. VIRGIN ISLANDS ...

Contact Magnavox Customer Care Center at:
1-800-705-2000

FOR EXCHANGE IN CANADA ...

1-800-661-6162 (French Speaking)
1-800-705-2000 (English or Spanish Speaking)

REPLACEMENT AS PROVIDED UNDER THIS WARRANTY IS THE EXCLUSIVE REMEDY FOR THE CONSUMER. MAGNAVOX SHALL NOT BE LIABLE FOR ANY INCIDENTAL OR CONSEQUENTIAL DAMAGES FOR BREACH OF ANY EXPRESS OR IMPLIED WARRANTY ON THIS PRODUCT. EXCEPT TO THE EXTENT PROHIBITED BY APPLICABLE LAW, ANY IMPLIED WARRANTY OF MERCHANTABILITY OR FITNESS FOR A PARTICULAR PURPOSE ON THIS PRODUCT IS LIMITED IN DURATION TO THE DURATION OF THIS WARRANTY.

Some states do not allow the exclusions or limitation of incidental or consequential damages, or allow limitations on how long an implied warranty lasts, so the above limitations or exclusions may not apply to you. In addition, if you enter into a service contract agreement with the MAGNAVOX partnership within ninety (90) days of the date of sale, the limitation on how long an implied warranty lasts does not apply.

This warranty gives you specific legal rights. You may have other rights which vary from state/province to state/province.

Magnavox, P.O. Box 520890, Miami, FL 33152 (402) 536-4171

EL6578E001 / 01-04

GARANTIE LIMITEE MAGNAVOX

Échange gratuit de quatre-vingt-dix (90) jours sur les produits

MAGNAVOX garantit ce produit contre tout défaut de matière et de main d'œuvre, sous réserve de toutes les conditions énoncées, comme suit :

PREUVE D'ACHAT :

Vous devez fournir une preuve de la date d'achat pour pouvoir échanger votre produit. Un reçu ou tout autre document faisant preuve de la date d'achat du produit et du détaillant agréé est considéré comme une preuve d'achat.

COUVERTURE :

La protection offerte par la garantie commence le jour où vous avez acheté votre produit. Pour une période de quatre-vingt-dix (90) jours à partir de la date d'achat, s'il est déterminé que le produit est défectueux, Magnavox s'engage à échanger le produit défectueux pour un produit neuf ou remis à neuf, à son choix, gratuitement. Le produit de remplacement n'est couvert que pour la période de garantie du produit d'origine. Lorsque la garantie du produit d'origine arrive à terme, la garantie sur tous les produits remplacés expire également. Lorsque vous devez renvoyer le produit à Magnavox pour l'échanger, vous devrez payer les frais d'expédition à Magnavox. Magnavox s'engage à payer les frais d'expédition pour le renvoi du produit à votre domicile.

Remarque : Le modèle d'échange fourni sera le modèle le plus comparable dans l'inventaire actuel de Magnavox. L'expédition de votre produit à Magnavox implique l'intention de respecter les exigences spécifiques de la garantie et du programme d'échange. Les produits reçus par Magnavox ne peuvent pas être retournés. Un produit de remplacement ne pourra être envoyé que si toutes les exigences de la garantie ont été respectées. Tout manquement de répondre à toutes les exigences pourra entraîner un délai dans la procédure d'échange.

EXCLUSIONS DE LA GARANTIE

Votre garantie ne couvre pas :

- les frais d'expédition pour le renvoi du produit défectueux.
- les frais de main d'œuvre pour l'installation ou la configuration du produit, le réglage des commandes sur le produit du client ainsi que l'installation ou la réparation du système d'antenne externe au produit.
- la réparation du produit et/ou le remplacement des pièces à cause d'une mauvaise installation, d'un raccordement à une alimentation électrique incorrecte, d'un emploi abusif, d'une négligence, d'un mauvais usage, d'un accident, d'une réparation non autorisée ou de toute autre cause non contrôlable par Magnavox.
- un produit nécessitant une modification ou adaptation afin de permettre l'utilisation dans tout pays autre que celui pour lequel il était désigné, fabriqué, approuvé et/ou autorisé ou toute réparation du produit endommagé par ces modifications.
- tout dommage au produit lors de l'expédition lorsque celui-ci n'a pas été emballé correctement ou tout frais associé à l'emballage.

- un produit perdu lors de l'expédition sans preuve signée de la réception.
- un produit utilisé à des fins commerciales ou institutionnelles (y compris mais non de façon limitative les fins de location).
- un produit vendu TEL QUEL ou RÉNOVÉ.

OÙ ÉCHANGER LE PRODUIT :

Le service d'échange est disponible dans tous les pays où le produit est distribué officiellement par Magnavox. Dans le cas où Magnavox n'est pas distributeur du produit dans votre pays, l'organisme de service Magnavox local tentera d'échanger le produit, bien qu'il y ait possibilité d'un délai si le produit approprié n'est pas disponible tout de suite ou si des procédures de douane spéciales sont nécessaires.

POUR ÉCHANGER UN PRODUIT AUX ÉTATS-UNIS, À PORTO RICO OU AUX ÎLES VIERGES AMÉRICAINES ...

Communiquez avec le centre de service à la clientèle de Magnavox au :

1-800-705-2000

POUR ÉCHANGER UN PRODUIT AU CANADA...

1-800-661-6162 (pour un service en français)

1-800-705-2000 (pour un service en anglais ou en espagnol)

LE REMPLACEMENT CONFORMÉMENT À CETTE GARANTIE CONSTITUE LE SEUL REMÈDE POUR LE CONSOMMATEUR. MAGNAVOX N'EST AUCUNEMENT RESPONSABLE DE TOUT DOMMAGE ACCESSOIRE OU INDIRECT RÉSULTANT DE LA VIOLATION DE TOUTE GARANTIE EXPRESSE OU IMPLICITE SUR CE PRODUIT. SAUF DANS LA MESURE INTERDITE PAR LES LOIS APPLICABLES, TOUTE GARANTIE IMPLICITE DE QUALITÉ LOYALE ET MARCHANDE OU D'UTILITÉ PARTICULIÈRE DU PRODUIT EST LIMITÉE DANS LE TEMPS À LA DURÉE DE CETTE GARANTIE.

Certains états ne reconnaissent pas l'exclusion ou la limitation de la responsabilité pour dommages indirects ou accessoires, ou autorisent des limitations sur la durée d'une garantie implicite, il est donc possible que les limitations ou exclusions mentionnées ci-dessus soient sans effet dans votre cas. En outre, si vous concluez une entente de contrat de service avec la société MAGNAVOX dans les quatre-vingt-dix (90) jours suivant la date d'achat, la limitation sur la durée de la garantie implicite ne s'applique pas.

Cette garantie vous donne des droits légaux spécifiques. Il est possible que vous bénéficiiez de droits supplémentaires variant d'un état/province à l'autre.

Magnavox, P.O. Box 520890, Miami, FL 33152 (402) 536-4171

EL6578F001 / 01-04

GARANTIE LIMITEE MAGNAVOX

Cambio gratuito del producto hasta noventa (90) días

MAGNAVOX garantiza este producto contra defectos en el material o en la mano de obra, sujeto a las condiciones que se establecen a continuación:

COMPROBANTE DE COMPRA:

Para cambiar el producto, debe presentar un comprobante de la fecha de su compra. Se considera como tal comprobante un recibo de venta o algún otro documento que indique tanto el producto y la fecha en que lo compró, como también el distribuidor minorista autorizado.

COBERTURA:

La cobertura de la garantía comienza el día en que usted compra el producto. Si se determina que el producto tiene defectos, Magnavox cambiará sin costo el producto defectuoso por uno nuevo o reacondicionado, según sea su criterio, durante un período de noventa (90) días a partir de la fecha de compra. El producto de reemplazo está cubierto sólo por el período de garantía del original. Cuando expira la garantía de éste, también expira la de todos los productos reemplazados. Cuando deba enviar el producto a Magnavox para su cambio, usted deberá pagar los costos de envío. Magnavox pagará los costos de envío al regresarle el producto.

Nota: El modelo por el que se cambie el producto será el de mayor similitud en el inventario actual de Magnavox. El envío de su producto a Magnavox implica el intento de seguir los requisitos especificados del programa de garantía e intercambio. No se puede devolver el producto que reciba Magnavox. El producto de reemplazo sólo se puede enviar si se cumplen todos los requisitos de la garantía. El incumplimiento de tales requisitos puede ocasionar el retardo en el proceso de cambio.

SIN COBERTURA DE GARANTÍA

Su garantía no cubre:

- Los costos de envío al devolver el producto defectuoso.
- Los costos de mano de obra por la instalación o preparación del producto, el ajuste de controles del cliente en el producto y la instalación o reparación de los sistemas de antena externos al producto.
- La reparación del producto y/o el reemplazo de piezas debido a la instalación inadecuada, a conexiones hechas a un suministro de voltaje inadecuado, al abuso, descuido, mal uso, accidentes, reparaciones no autorizadas u otras causas que no se encuentren en control de Magnavox.
- Un producto que requiera modificación o adaptación para permitir su operación en cualquier país que no sea el país para el que se diseñó, fabricó, aprobó y/o autorizó o la reparación de productos dañados por estas modificaciones.
- Los daños al producto durante el envío cuando el empaque no ha sido el adecuado o los costos asociados con el empaque.
- La pérdida del producto en el traslado y cuando no se pueda proporcionar una firma que verifique el recibo.

- Un producto que se use para propósitos comerciales o institucionales (lo que incluye, entre otros, los de alquiler).
- Producto vendido TAL COMO ESTÁ o RENOVADO.

DÓNDE SE ENCUENTRA DISPONIBLE EL CAMBIO POR GARANTÍA:

El cambio se encuentra disponible en todos los países en que Magnavox distribuya oficialmente el producto. En los países en que Magnavox no distribuye el producto, la organización Magnavox local intentará cambiar el producto, aunque puede haber un retardo si no es fácil disponer del producto o si existen procesos especiales de aduana.

PARA REALIZAR CAMBIOS EN EE.UU., PUERTO RICO O EN LAS ISLA VÍRGENES DE EE.UU...

Comuníquese con el Centro de Atención al Cliente al:
1-800-705-2000

PARA REALIZAR CAMBIOS EN CANADÁ...

1-800-661-6162 (si habla francés)
1-800-705-2000 (si habla inglés o español)

EL REEMPLAZO, SEGÚN LO DISPONE ESTA GARANTÍA, ES LA SOLUCIÓN EXCLUSIVA PARA EL CLIENTE. MAGNAVOX NO SERÁ RESPONSABLE DE LOS DAÑOS CASUALES O EMERGENTES QUE INFRINJAN ALGUNA GARANTÍA EXPRESA O IMPLÍCITA SOBRE ESTE PRODUCTO. CON EXCEPCIÓN DE LO QUE PROHIBA LA LEY VIGENTE, TODA GARANTÍA IMPLÍCITA DE COMERCIABILIDAD Y ADECUACIÓN PARA UN PROPÓSITO PARTICULAR EN ESTE PRODUCTO ESTÁ LIMITADA EN DURACIÓN A LO QUE ESPECIFIQUE ESTA GARANTÍA.

Algunos estados no permiten las exclusiones o la limitación de los daños casuales o importantes, ni permiten limitaciones sobre la duración de la garantía implícita, de modo que es posible que las limitaciones o exclusiones anteriores no se apliquen a usted. Además, si usted celebra un contrato de servicio con la sociedad MAGNAVOX en un plazo de noventa (90) días a partir de la fecha de venta, no se aplicará la limitación sobre la duración de la garantía implícita.

Esta garantía le otorga derechos legales específicos. Usted puede tener otros derechos que varían entre los diferentes estados y provincias.

Magnavox, P.O. Box 520890, Miami, FL 33152 (402) 536-4171

EL6578S001 / 01-04

Free Manuals Download Website

<http://myh66.com>

<http://usermanuals.us>

<http://www.somanuals.com>

<http://www.4manuals.cc>

<http://www.manual-lib.com>

<http://www.404manual.com>

<http://www.luxmanual.com>

<http://aubethermostatmanual.com>

Golf course search by state

<http://golfingnear.com>

Email search by domain

<http://emailbydomain.com>

Auto manuals search

<http://auto.somanuals.com>

TV manuals search

<http://tv.somanuals.com>