

Owner`s Manual

26MD255V LCD TV

MAGNAVOX
SMART. VERY SMART.



NEED HELP?CALL US!

MAGNAVOX REPRESENTATIVES ARE READY TO HELP YOU WITH ANY QUESTIONS ABOUT YOUR NEW PRODUCT. WE CAN GUIDE YOU THROUGH CONNECTIONS, FIRST-TIME SETUP, AND ANY OF THE FEATURES. WE WANT YOU TO START ENJOYING YOUR NEW PRODUCT RIGHT AWAY.

CALL US BEFORE YOU CONSIDER RETURNING THE PRODUCT.

1-800-705-2000

OR VISIT US ON THE WEB AT WWW.USASUPPORT.MAGNAVOX.COM

Important!

Return your Warranty Registration Card within 10 days.

TABLE OF CONTENTS

IMPORTANT INFORMATION.....	2
IMPORTANT SAFETY INSTRUCTIONS.....	3-4
SUPPLIED ACCESSORIES.....	5
REMOTE CONTROL.....	6-7
FUNCTIONAL OVERVIEW.....	8
CONNECTIONS.....	9
BASIC OPERATIONS.....	10
WATCHING TV.....	11-12
MENU ADJUSTMENT.....	13-18
BASIC OPERATIONS DVD.....	19-24
PLAY DISCS IN VARIOUS WAYS.....	24-29
MENU SETTING DVD.....	30-34
KODAK PICTURE CD PLAYBACK.....	35
TROUBLESHOOTING.....	36-37
TECHNICAL SPECIFICATIONS.....	38
WARRANTY PAGE.....	39

IMPORTANT INFORMATION

WARNING: TO REDUCE THE RISK OF FIRE OR ELECTRIC SHOCK, DO NOT EXPOSE THIS PRODUCT TO RAIN OR MOISTURE.



The lightning flash with arrowhead symbol, within an equilateral triangle, is intended to alert the user to the presence of uninsulated "dangerous voltage" within the product's enclosure that may be of sufficient magnitude to constitute a risk of electric shock to persons.



The exclamation point within a triangle is intended to alert the user to the presence of important operation and maintenance (servicing) instructions in the literature accompanying the product.

FCC RF INTERFERENCE STATEMENT

NOTE: This equipment has been tested and found to comply with the limit for a Class B digital device, pursuant to Part 15 of the FCC Rules. These limits are designed to provide reasonable protection against harmful interference in a residential installation.

This equipment generates, uses and can radiate radio frequency energy and, if not installed and used in accordance with the instructions, may cause harmful interference to radio communications. However, there is no guarantee that interference will not occur in a particular installation.

If this equipment does not cause harmful interference to radio or television reception which can be determined by turning the equipment off and on, the user is encourage to try to correct the interference by one or more of the following measure.

- Reorient or relocate the receiving antenna.
- Increase the separation between the equipment and receiver.
- Correct the equipment into an outlet on a circuit different from that to which the receiver is connected.
- Consult the dealer or an experienced radio, TV technical for help.
- Only shielded interface cable should be used.

IMPORTANT SAFETY PRECAUTIONS

The present set has been designed and manufactured to assure personal safety. Improper use can result in electric shock or fire hazard. The safeguards incorporated in the present unit will protect you if you observe the following procedures in installing, using and servicing. The present unit is fully transistorized and does not contain any element that can be repaired by the user.

1. Read these instructions.
2. Keep these instructions.
3. Heed all warnings.
4. Follow all instructions.
5. Do not use this apparatus near water.
6. Clean only with dry cloth.
7. Do not block any ventilation openings. Install in accordance with the manufacturer's instructions.
8. Do not install near any heat sources such as radiators, heat registers, stoves, or other apparatus (including amplifiers) that produce heat.
9. Do not defeat the safety purpose of the polarized or grounding-type plug. A polarized plug has two blades with one wider than the other. A grounding type plug has two blades and a third grounding prong. The wide blade or the third prong are provided for your safety. If the provided plug does not fit into your outlet, consult an electrician for replacement of the obsolete outlet.
10. Protect the power cord from being walked on or pinched particularly at plugs, convenience receptacles, and the point where they exit from the apparatus.
11. Only use attachments/accessories specified by the manufacturer.
12. Use only with the cart, stand, tripod, bracket, or table specified by the manufacturer, or sold with the apparatus. When a cart is used, use caution when moving the cart/apparatus combination to avoid injury from tip-over.
13. Unplug this apparatus during lightning storms or when unused for long periods of time.
14. Refer all servicing to qualified service personnel. Servicing is required when the apparatus has been damaged in any way, such as power-supply cord or plug is damaged, liquid has been spilled or objects have fallen into the apparatus, the apparatus has been exposed to rain or moisture, does not operate normally, or has been dropped.
15. Repair - If any of the following conditions occurs, unplug the AC cord from the AC outlet, and request a qualified service person to perform repairs.
 - a) When the AC cord or plug is damaged.
 - b) When a liquid was spilled on the product or when objects have fallen into the product.
 - c) When the product has been exposed to rain or water.



IMPORTANT SAFETY PRECAUTIONS

- d) When the product does not operate properly as described in the operating instructions. Do not touch the controls other than those described in the operating instructions. Improper adjustment of controls not described in the instructions can cause damage, which often requires extensive adjustment work by a qualified technician.
 - e) When the product has been dropped or damaged.
 - f) When the product displays an abnormal condition. Any noticeable abnormality in the product indicates that the product needs servicing.
16. Replacement parts - In case the product needs replacement parts, make sure that the service person uses replacement parts specified by the manufacturer, or those with the same characteristics and performance as the original parts. Use of unauthorized parts can result in fire, electric shock and/or other danger.
 17. The LCD panel used in this product is made of glass. Therefore, it can be broken when the product is dropped or gets shock. Be careful not to be injured by glass pieces in case the panel is broken.
 18. The LCD panel is a product of very high technology with 2,949,120 thin film transistors, giving you fine picture details. Occasionally, a few non-active pixels may appear on the screen as a fixed blue, green or red point. Please note that this does not affect your product's performance.

SUPPLIED ACCESSORIES

Make sure the following accessories are provided with the product.



Power adapter



Remote control

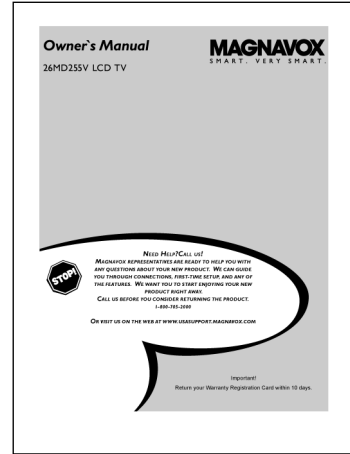

Owner's Manual

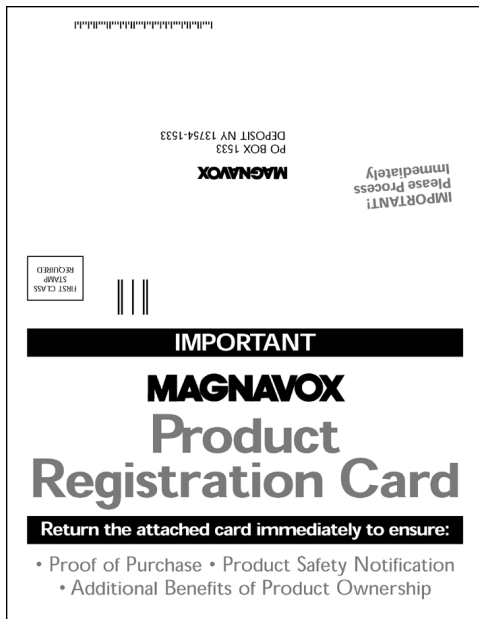

Warranty card



AAA batteries

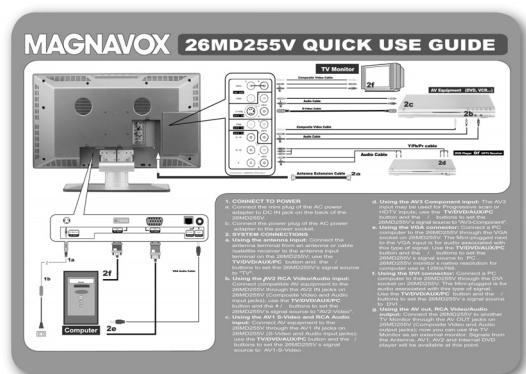

Quick setup guide

REMOTE CONTROL

INSERTING BATTERIES INTO THE REMOTE CONTROL

Insert supplied batteries via the battery compartment on the back of the remote control. Make sure polarity matches the (+) and (-) marks inside the compartment.

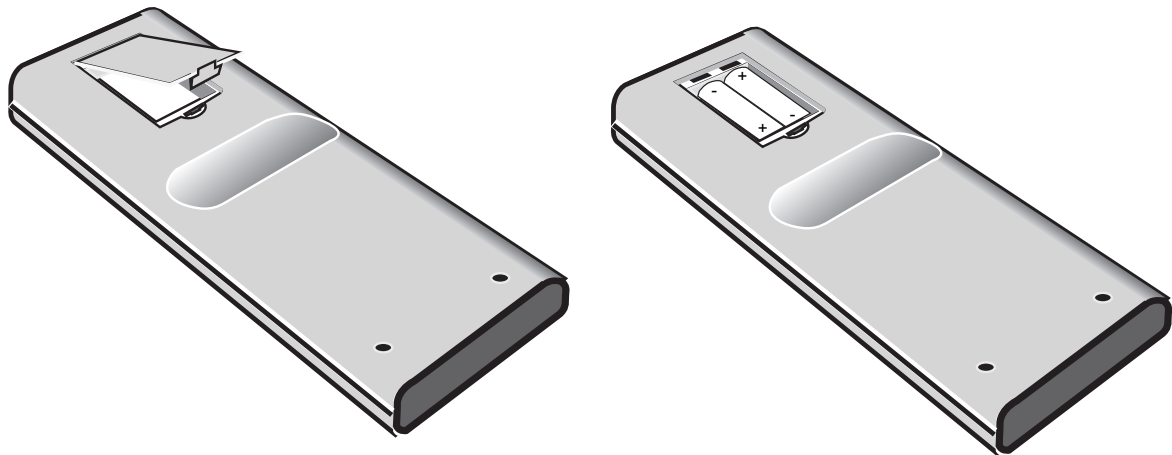

USING THE REMOTE CONTROL UNIT

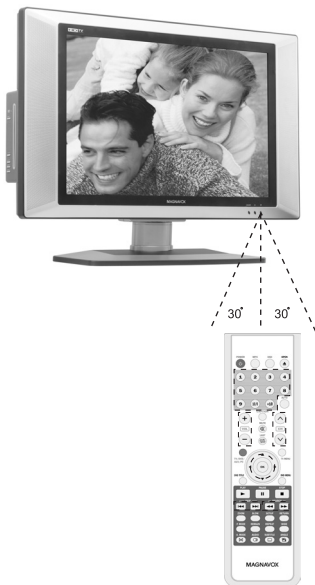

- Use the remote control by pointing it towards the remote sensor on the TV. Objects between the remote control and the sensor may disrupt operation.
- Effective range is 20 feet but is dependant on what your viewing angle is.
- Range can also be affected by direct sunlight on the TV's sensor.

CAUTIONS REGARDING REMOTE CONTROL UNIT

- Do not expose remote to liquids, direct sunlight or shock.
- The remote control unit may not work properly if the remote sensor window of the Display is under direct sunlight or strong lighting. In such case, change the angle of the lighting or Display, or operate the remote control unit closer to the remote sensor window.

REMOTE CONTROL

POWER

Use to turn the unit on and off.

Number Buttons

Use to set the channel and to enter DVD chapter numbers.

CAPTION

Use to select close caption mode.

VOLUME+/-

Use to adjust the volume.

LAST

Press to return to the previous channel in normal viewing mode.

TV/DVD/AUX/PC

Use to bring up the AV signal source selection screen and use the ▲/▼ buttons to select between: TV, DVD, AV1-S-Video, AV2-Video, AV3-Component, PC-Analog(VGA), PC-Digital(DVI), and press the **OK** button to confirm.

Cursor Buttons

Use to navigate in menus.

OK

Use to confirm your selections.

DVD TITLE

Use to bring up the DVD title menu.

PLAY

Use to begin the DVD playback.

PAUSE

Use to pause the DVD playback.

PREV/NEXT

Use to skip to the previous/next chapter.

ZOOM

Use to zoom the DVD playback picture.

SLOW

Use to slow the DVD playback speed.

P. MODE

Use to shift DVD play mode.

REMAIN

Use to display the time of the DVD playback.

A. MODE

Use to shift the DVD playback audio mode.

AUDIO

Use to shift DVD audio language.

MPX

Use to select the sound multiplex mode. (See page 16.)

OSD

Use to bring up the DVD On-Screen-Display.

OPEN(▲)

Use to eject the disc being played in the disc slot, the main unit must be set to DVD status.

AUTO

Auto adjustment for PC signals.

MUTE

Mute the sound.

CH+/-

Use to skip to the previous/next channel.

TV MENU

Use to bring up TV menu; and exits TV menu by pressing again.

DVD MENU

Use to bring up the DVD root menu.

STOP

Use to stop the DVD playback.

FF/FR

Use to play DVD fast forward/backward.

RETURN

Return to the previous menu screen.

SETUP

Use to bring up DVD setup menu.

WIDE

In DVD mode, use to set TV display mode.

ANGLE

Use to shift DVD viewing angle.

REPEAT

Use to repeat the DVD playback.

SUBTITLE

Use to shift DVD subtitle language.

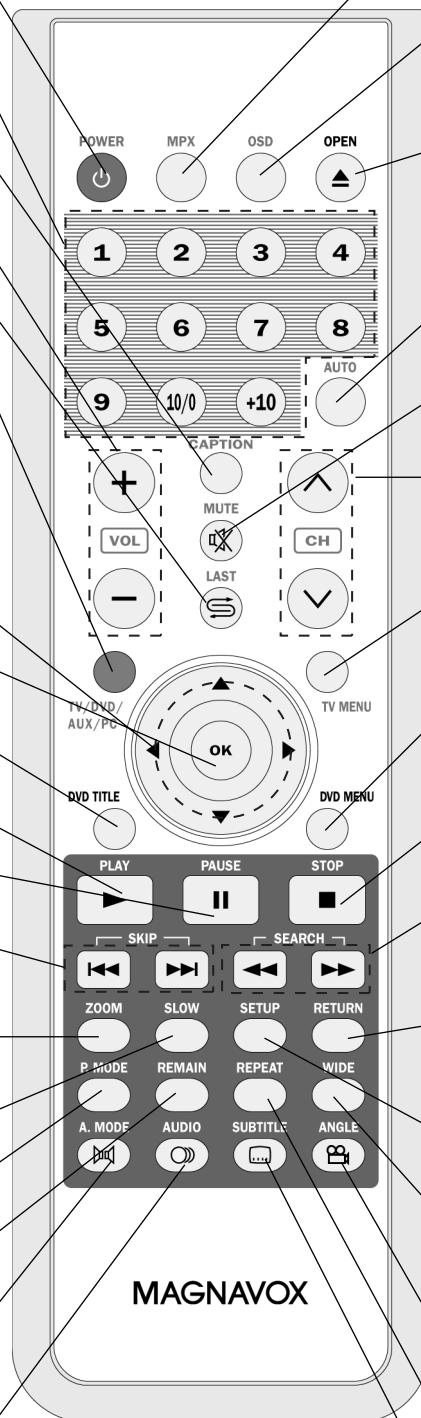

FUNCTIONAL OVERVIEW

FRONT VIEW

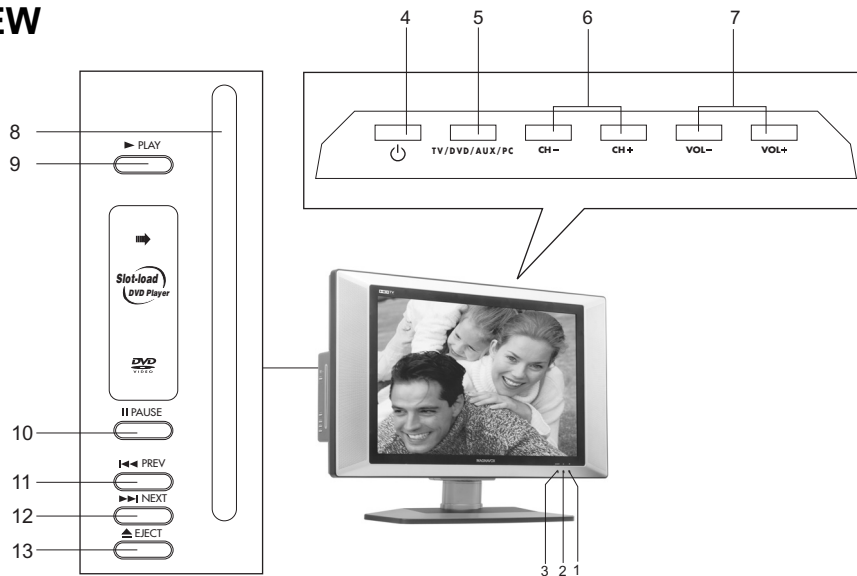

- 1) REMOTE SENSOR
- 2) POWER ON INDICATOR
- 3) STANDBY INDICATOR
- 4) POWER BUTTON: Use to turn the unit on and off.
- 5) TV/DVD/AUX/PC: Use to select the AV signal source among: TV, DVD, AV1-S-Video, AV2-Video, AV3-Component, PC-Analog(VGA), PC-Digital(DVI) and use the **OK** button to confirm.
- 6) CH+/-: To skip to the previous/next channel.
- 7) VOLUME +/-: Use to adjust the volume.
- 8) DISC SLOT: Insert a DVD or CD disc to play under DVD status.
- 9) PLAY BUTTON: Use to begin the DVD playback.
- 10) PAUSE BUTTON: Use to pause the DVD playback.
- 11) PREV: Use to skip to the previous chapter.
- 12) NEXT: Use to skip to the next chapter.
- 13) EJECT BUTTON: Use to eject the disc being played in the disc slot.

REAR VIEW

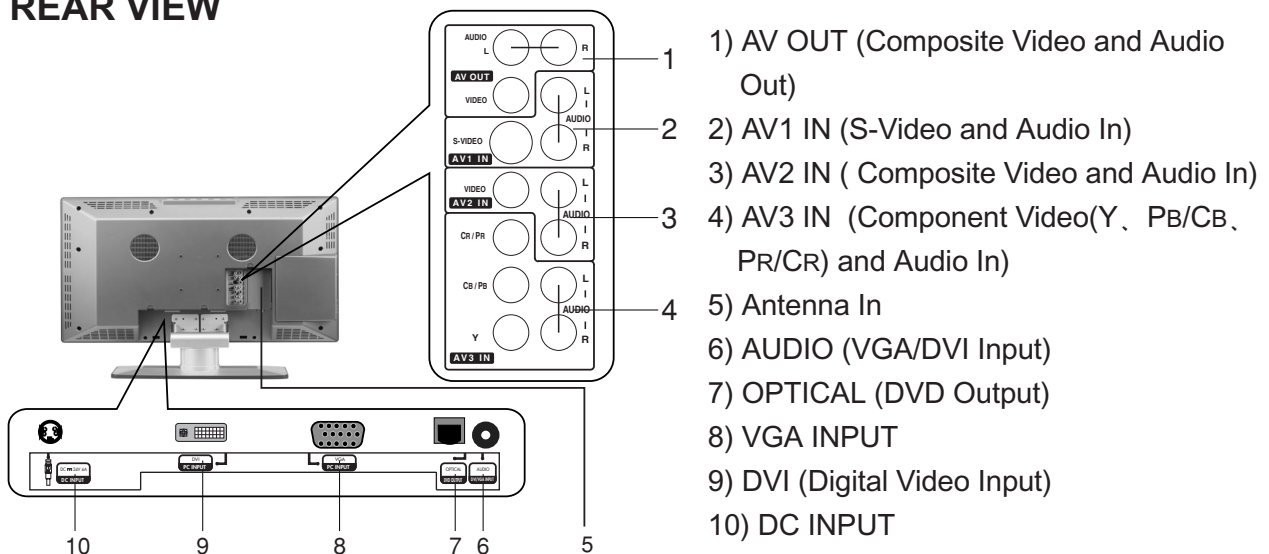

CONNECTIONS

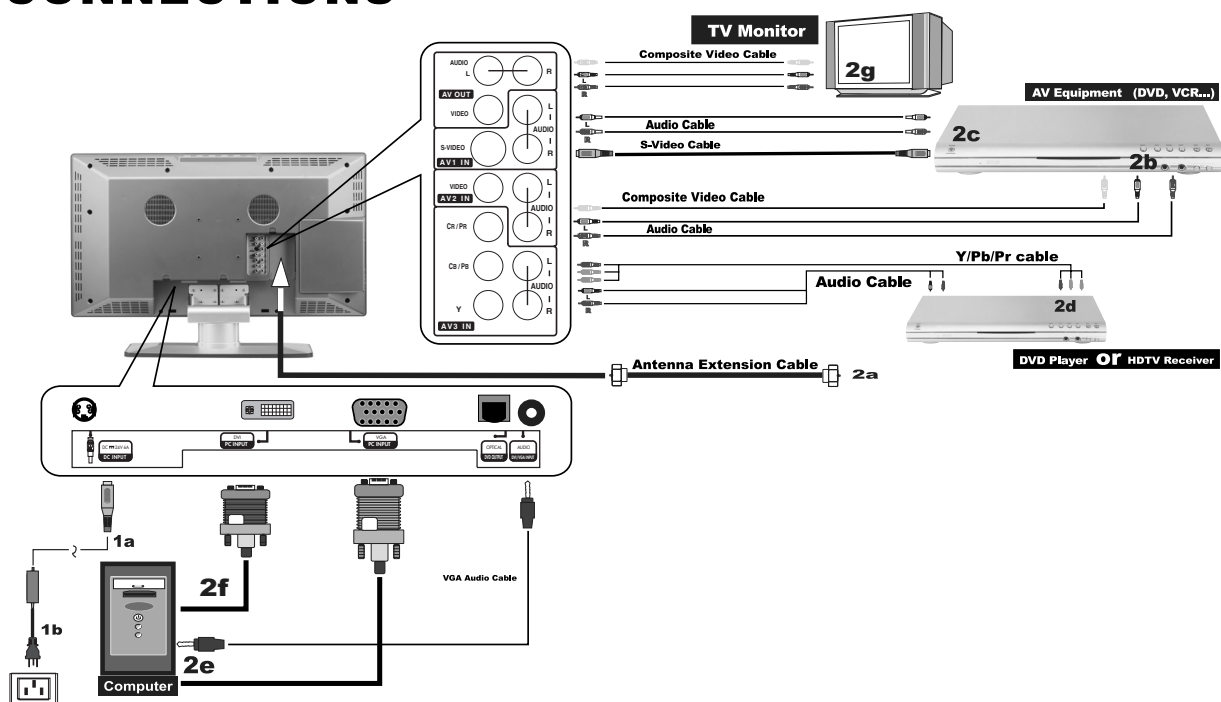

1. CONNECT TO POWER

- a. Connect the mini plug of the AC power adapter to DC IN jack on the back of the 26MD255V.
- b. Connect the power plug of the AC power adapter to the power socket.

2. SYSTEM CONNECTIONS

- a. **Using the antenna input:** Connect the antenna terminal from an antenna or cable /satellite receiver to the antenna input terminal on the 26MD255V; use the **TV/DVD/AUX/PC** button and the **▲ / ▼** buttons to set the 26MD255V's signal source to "TV".
- b. **Using the AV2 RCA Video/Audio input:** Connect compatible AV equipment to the 26MD255V through the AV2 IN jacks on 26MD255V (Composite Video and Audio input jacks); use the **TV/DVD/AUX/PC** button and the **▲ / ▼** buttons to set the 26MD255V's signal source to "AV2-Video".
- c. **Using the AV1 S-Video and RCA Audio input:** Connect AV equipment to the 26MD255V through the AV1 IN jacks on 26MD255V (S-Video and Audio input jacks); use the **TV/DVD/AUX/PC** button and the **▲ / ▼** buttons to set the 26MD255V s signal source to AV1-S-Video .

- d. **Using the AV3 Component input:** The AV3 input may be used for Progressive scan or HDTV inputs; use the **TV/DVD/AUX/PC** button and the **▲ / ▼** buttons to set the 26MD255V's signal source to "AV3-Component".
- e. **Using the VGA connector:** Connect a PC computer to the 26MD255V through the VGA socket on 26MD255V. The Mini-plugged next to the VGA input is for audio associated with this type of signal. Use the **TV/DVD/AUX/PC** button and the **▲ / ▼** buttons to set the 26MD255V s signal source to PC-Analog(VGA) . 26MD255V monitor s native resolution for computer use is 1280x768.
- f. **Using the DVI connector:** Connect a PC computer to the 26MD255V through the DVI socket on 26MD255V. The Mini-plugged is for audio associated with this type of signal. Use the **TV/DVD/AUX/PC** button and the **▲ / ▼** buttons to set the 26MD255V s signal source to PC-Digital(DVI) .
- g. **Using the AV out, RCA Video/Audio output:** Connect the 26MD255V to another TV Monitor through the AV OUT jacks on 26MD255V (Composite Video and Audio output jacks); now you can use the TV Monitor as an external monitor. Signals from the Antenna, AV1, AV2 and Internal DVD player will be available at this point.

BASIC OPERATIONS

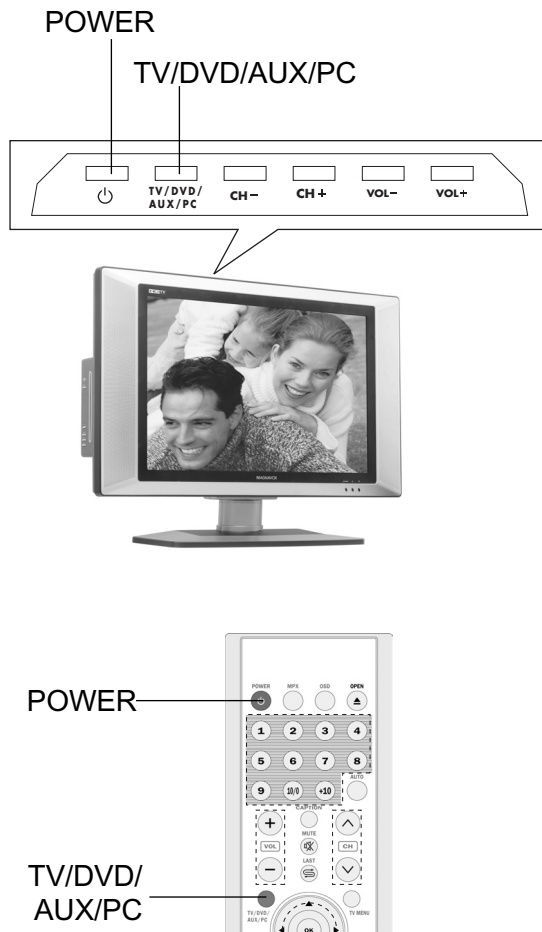

TURNING OFF THE POWER

1. Press **POWER** on the remote control, the image on the screen disappears and the **STANDBY** indicator lights up red.

NOTE: Small amounts of electric power is still consumed even when the power is turned off.

TV/AV MODE SELECTION

By pressing the **TV/DVD/AUX/PC** on the TV set and confirming by the **OK** button, you can change the mode as follows:

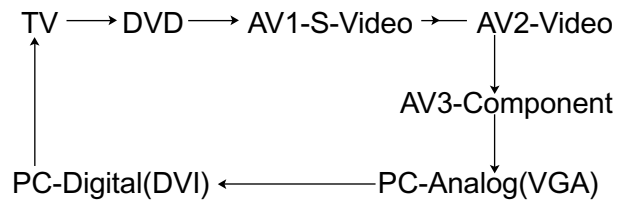

TURNING ON THE POWER

1. Press **POWER** button on the front panel to turn on the TV set. The **POWER** indicator lights up green.
2. If the **STANDBY** indicator still lights up red, press **POWER** on the remote control to turn the TV set on.

WATCHING TV

TURNING ON THE POWER

1. Press **POWER** button on the front panel to turn on the TV set. The POWER indicator lights up green.
2. If the STANDBY indicator still lights up red, press **POWER** on the remote control to turn the TV set on.

TURNING OFF THE POWER

1. Press **POWER** on the remote control, the image on the screen disappears and the STANDBY indicator lights up red.

NOTE: Weak electric power is still consumed even when the power is turned off.

SIMPLE BUTTON OPERATIONS FOR CHANGING CHANNELS

You can change channels in several ways.

Using CH+/- on the remote unit

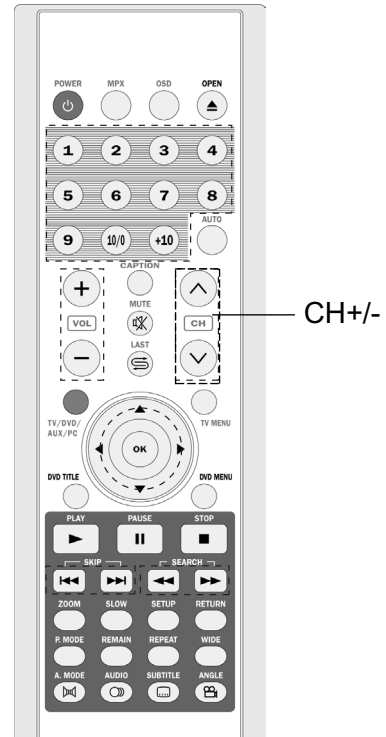
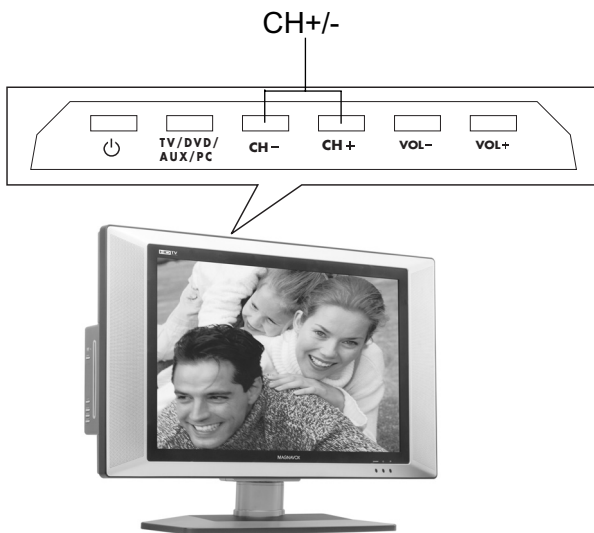

1. Press **CH+** to increase channel number.
2. Press **CH-** to decrease channel number.

NOTE: **CH+/-** on the TV set operates the same as **CH+/-** on the remote unit.

WATCHING TV

Using number buttons on the remote unit

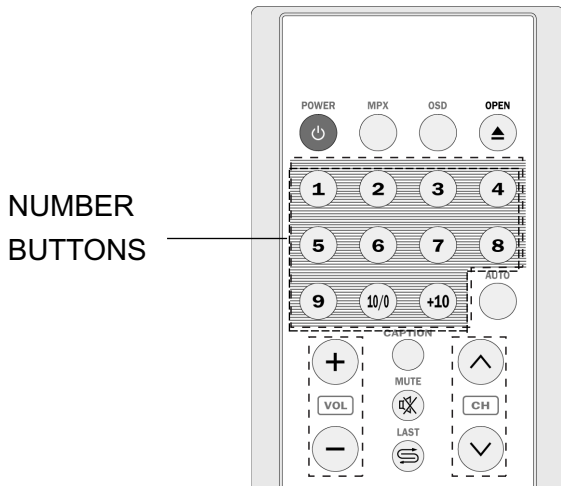

Select the channels directly by pressing the number buttons.

EXAMPLE:

To select a 1-digit channel (e.g. channel 2):

- Press **2** .

To select a 2-digit channel (e.g. channel 12):

- Press **1** , followed by **2** .

USING LAST ON THE REMOTE UNIT

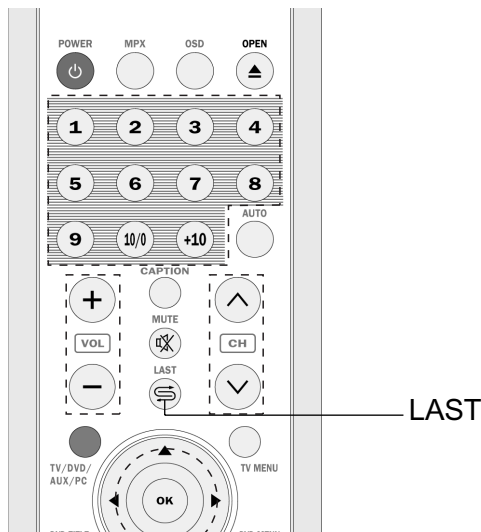

Press **LAST** to switch the currently tuned channel to the previous tuned channel.

Press **LAST** again to switch back to the currently tuned channel.

SIMPLE BUTTON OPERATION FOR CHANGING VOLUME/SOUND

Changing the volume

You can change the volume on the front panel or on the remote control unit.

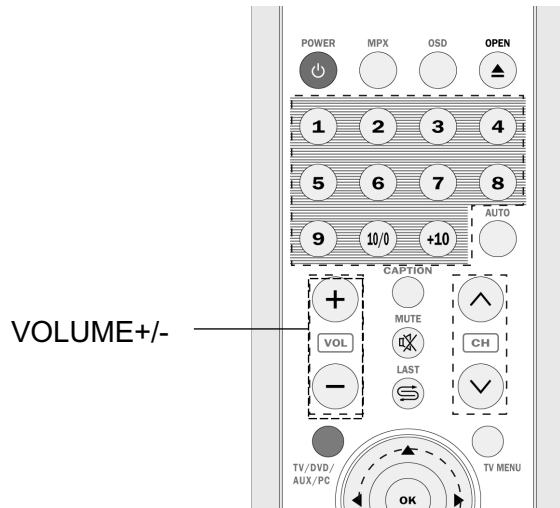

1. Press **VOL+** to increase the volume.
2. Press **VOL-** to decrease the volume.

Using MUTE on the remote control

Press **MUTE** to mute the current sound output.

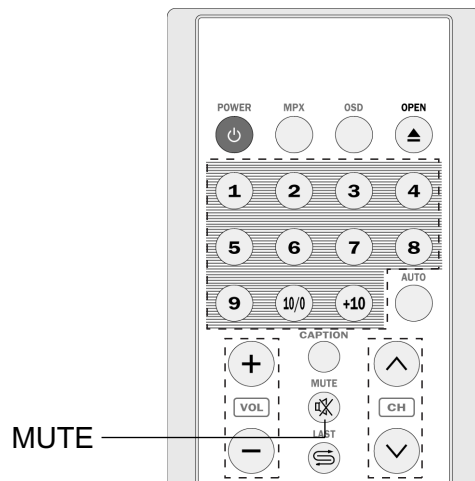

1. Press **MUTE** . " ~~XX~~ " will display on the screen.
2. Press **MUTE** again to cancel the mute.

MENU ADJUSTMENT

TV TUNER ADJUSTMENT

Press **TV MENU** to bring up the TV menu screen.

Press ◀ / ▶ to select "Settings" and press ▼ to enter into the items below "Settings".

NOTE: Only when in TV status, there is "TV Tuner" option below "Settings".

Make sure press **TV MENU** to exit TV menu screen before other operations.

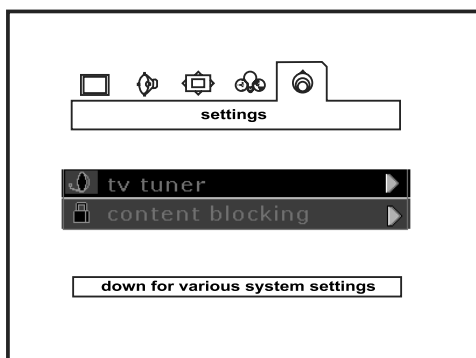

Cable

1. Press **TV MENU** to bring up the TV menu screen.
2. Press ◀ / ▶ to select "Settings" and press ▼ to select "TV Tuner".
3. Press ▶ to enter "TV Tuner" menu.

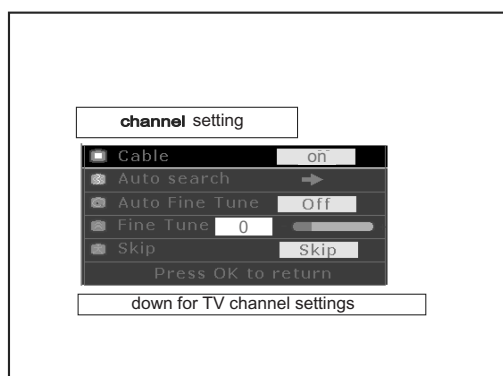

4. Press ▲ / ▼ to select "Cable".
5. Press ◀ / ▶ to change cable on and off; press **OK** to return; press **TV MENU** to exit.

Automatic channel search

Channel auto search finds and memorizes all channels viewable in your area.

1. Press **TV MENU** to bring up the TV menu screen.
2. Press ◀ / ▶ to select "Settings" and press ▼ to select "TV Tuner".
3. Press ▶ to enter "TV Tuner" menu.
4. Press ▲ / ▼ to select "Auto Search".
5. Press ▶ to begin the searching. Wait until the searching ends.

NOTE: The illustrations and on-screen displays in this manual are for explanation purposes and may vary from the actual operations.

Auto Fine Tune

1. Press **TV MENU** to bring up the TV menu screen.
2. Press ◀ / ▶ to select "Settings" and press ▼ to select "TV Tuner".
3. Press ▶ to enter "TV Tuner" menu.
4. Press ▲ / ▼ to select "Auto Fine Tune".
5. Press ◀ / ▶ to select between on and off ; press **OK** to return; press **TV MENU** to exit.

Fine tune

1. Press **TV MENU** to bring up the TV menu screen.
2. Press ◀ / ▶ to select "Settings" and press ▼ to select "TV Tuner".
3. Press ▶ to enter "TV Tuner" menu.
4. Press ▲ / ▼ to select "Fine Tune".
5. Press ▶ to enter "Fine Tune" screen.
6. Press ◀ / ▶ to tune for a better picture and sound; press **OK** to return; press **TV MENU** to exit.

Channel skip

1. Press **TV MENU** to bring up the TV menu screen.
2. Press ◀ / ▶ to select "Settings" and press ▼ to select "TV Tuner".
3. Press ▶ to enter "TV Tuner" menu.
4. Press ▲ / ▼ to select "Skip".
5. Press ◀ / ▶ to select between "Skip" and "Add"; press **OK** to return; press **TV MENU** to exit.

MENU ADJUSTMENT

CONTENT BLOCKING

Password

1. Press **TV MENU** to bring up the TV menu screen.
2. Press **◀ / ▶** to select "Settings" and press **▼** to select "Content Blocking".
3. Press **▶** to enter "Content Blocking (Password)" menu.

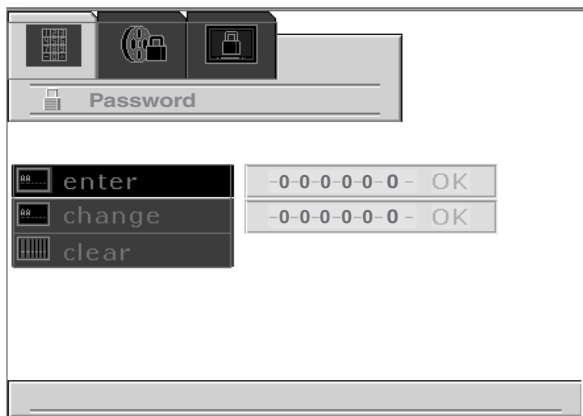

4. Press **▼** to select "Enter" and press **▶** to enter the password.
5. Press **◀ / ▶** to select digit and press **▲ / ▼** to change the selected digit.
6. Press **▶** to select "OK" and press **OK** to check the password. Then there will be "Change" and "Clear" under "Enter".

7. Press **▼** to select "Change" and press **▶** to change the password.
8. Press **◀ / ▶** to select digit and press **▲ / ▼** to change the selected digit.
9. Press **▶** to select "OK" and press **OK** to confirm your change.
10. Press **▼** to select "Clear" and press **▶** to clear the password; press **OK** to return; press **TV MENU** to exit.

NOTE:The preset password is 071100.

- Enter 071100 , there will be ERROR displayed on the screen.
- Enter 071100 again, the menu for changing password appears.

MENU ADJUSTMENT

PICTURE ADJUSTMENT

Press **TV MENU** to bring up the TV menu screen.

Press ◀ / ▶ to select "Picture" and press ▼ to enter into below items.

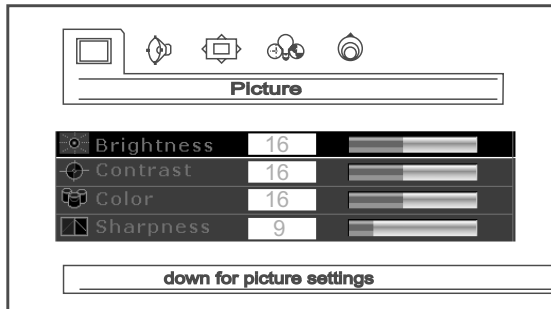

Brightness

1. Press **TV MENU** to bring up the TV menu screen.
2. Press ◀ / ▶ to select "Picture".
3. Press ▲ / ▼ to move to "Brightness".
4. Press ◀ / ▶ to adjust the picture brightness; press **OK** to return; press **TV MENU** to exit.

Contrast

1. Press **TV MENU** to bring up the TV menu screen.
2. Press ◀ / ▶ to select "Picture".
3. Press ▲ / ▼ to move to "Contrast".
4. Press ◀ / ▶ to adjust the picture contrast; press **OK** to return; press **TV MENU** to exit.

Color

1. Press **TV MENU** to bring up the TV menu screen.
2. Press ◀ / ▶ to select "Picture".
3. Press ▲ / ▼ to move to "Color".
4. Press ◀ / ▶ to adjust the picture color; press **OK** to return; press **TV MENU** to exit.

Sharpness

1. Press **TV MENU** to bring up the TV menu screen.
2. Press ◀ / ▶ to select "Picture".
3. Press ▲ / ▼ to move to "Sharpness".
4. Press ◀ / ▶ to adjust the picture sharpness; press **OK** to return; press **TV MENU** to exit.

NOTE: In DVD status, there is no "Sharpness"; there is "Phase".

AUDIO ADJUSTMENT

Press **TV MENU** to bring up the TV menu screen.

Press ◀ / ▶ to select "Audio" and press ▼ to enter into below items.

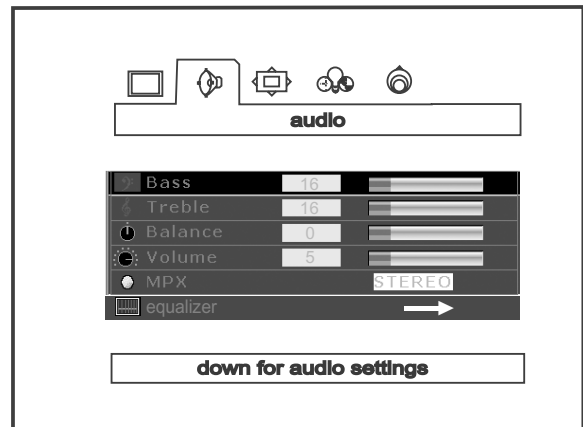

Volume

1. Press **TV MENU** to bring up the TV menu screen.
2. Press ◀ / ▶ to select "Audio".
3. Press ▲ / ▼ to move to "Volume".
4. Press ◀ / ▶ to adjust the volume; press **OK** to return; press **TV MENU** to exit.

Bass

1. Press **TV MENU** to bring up the TV menu screen.
2. Press ◀ / ▶ to select "Audio".
3. Press ▲ / ▼ to move to "Bass".
4. Press ◀ / ▶ to adjust the bass weaker or stronger; press **OK** to return; press **TV MENU** to exit.

Treble

To stress high frequency sound

1. Press **TV MENU** to bring up the TV menu screen.
2. Press ◀ / ▶ to select "Audio".
3. Press ▲ / ▼ to move to "Treble".
4. Press ◀ / ▶ to adjust the treble weaker or stronger; press **OK** to return; press **TV MENU** to exit.

MENU ADJUSTMENT

AUDIO ADJUSTMENT (CONTINUED)

Balance

1. Press **TV MENU** to bring up the TV menu screen.
2. Press ◀ / ▶ to select "Audio".
3. Press ▲ / ▼ to move to "Balance".
4. Press ◀ / ▶ to adjust audio output between left and right speakers; press **OK** to return; press **TV MENU** to exit.

MPX

This function is to select a MPX mode.

1. Press **TV MENU** to bring up the TV menu screen.
2. Press ◀ / ▶ to select "Audio".
3. Press ▲ / ▼ to move to "MPX".
4. Press ◀ / ▶ to select a MPX mode; press **OK** to return; press **TV MENU** to exit.

- NOTE:**
1. You can also use the **MPX** button on the remote control to select a MPX mode.
 2. Only when in TV status, there is MPX option.

Equalizer

1. Press ▲ / ▼ to select "Equalizer" in "Audio" menu.
2. Press ▶ to enter "Equalizer" menu to adjust.



3. Press **OK** to exit and return to "Audio" menu.
4. Press **TV MENU** to exit.

WINDOW ADJUSTMENT

PC mode input format

	Resolution	Freq. (Hz)
VGA	640 × 480	60
	640 × 480	72
	640 × 480	75
SVGA	800 × 600	60
	800 × 600	75
	800 × 600	72
XGA	1024 × 768	60
	1024 × 768	70
	1024 × 768	75
WXGA	1280 × 768	60
SXGA	1280 × 1024	60

In case of inputting the PC signal other than above signals, "OUT OF RANGE" will display.

Press **TV MENU** to bring up the TV menu screen.

Press ◀ / ▶ to select "Window" and press ▼ to enter into below items.

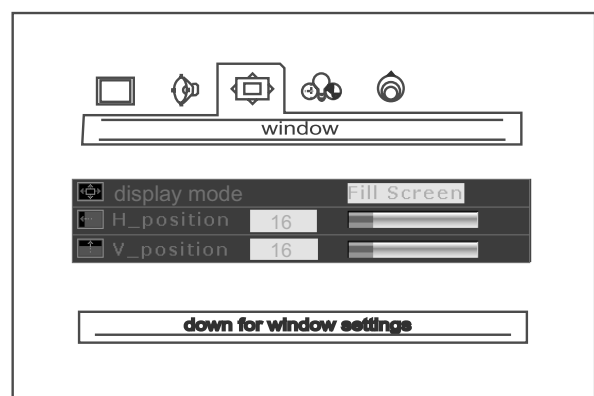

MENU ADJUSTMENT

WINDOW ADJUSTMENT (CONTINUED)

Display Mode

1. Press **TV MENU** to bring up the TV menu screen.
2. Press ◀ / ▶ to select "Window".
3. Press ▲ / ▼ to move to "Display Mode".
4. Press ◀ / ▶ to select a Display mode; press **OK** to return; press **TV MENU** to exit.

H-Position

1. Press **TV MENU** to bring up the TV menu screen.
2. Press ◀ / ▶ to select "Window".
3. Press ▲ / ▼ to move to "H-Position".
4. Press ◀ / ▶ to adjust the horizontal position of displayed image; press **OK** to return; press **TV MENU** to exit.

V-Position

1. Press **TV MENU** to bring up the TV menu screen.
2. Press ◀ / ▶ to select "Window".
3. Press ▲ / ▼ to move to "V-Position".
4. Press ◀ / ▶ to adjust the vertical position of displayed image; press **OK** to return; press **TV MENU** to exit.

NOTE: In TV, VIDEO, S-VIDEO and COMPONENT Status, there is only Display Mode option.

OPTIONS ADJUSTMENT

Press **TV MENU** to bring up the TV menu screen.

Press ◀ / ▶ to select "Options" and press ▼ to enter into below items.

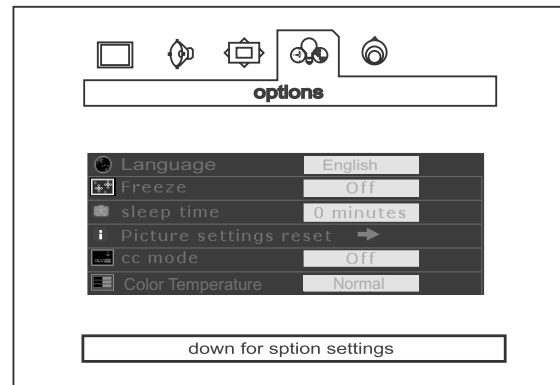

Language

It is used to set the menu language between : English, French and Spanish.

1. Press ▲ / ▼ to select "Language " in "Option" menu.
2. Press ◀ / ▶ to adjust the language between : English, French and Spanish.
3. Press **TV MENU** to exit.

Freeze

It is used to freeze the image.

1. Press ▲ / ▼ to select "Freeze" in "Options" menu.
2. Press ◀ / ▶ to select ON or OFF in Freeze .
 - ON: Freeze the image being played.
 - OFF: Turn off Freeze , the image continue playing.
3. Press **TV MENU** to exit.

BASIC OPERATIONS (FOR DVD PLAYER)

Play Discs

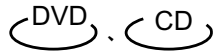

1. Press **POWER** to turn on the unit.
2. Press the **TV/DVD/AUX/PC** button on the remote control to bring up the AV signal source selection screen and use the **▲/▼** buttons to select "DVD", press the **OK** button to confirm.
3. Insert a disc into the disc slot, with the label side facing to yourself.
4. The unit begins to read the disc.
5. Press **▶** (PLAY) to play the disc.

AFTER STEP 4 IS FINISHED:

- If playing a DVD, the TV screen shows DVD menu or title menu.
 - If playing a CD, press **▶** (PLAY), and the unit plays the disc according to the track numbers.
5. Stop playback.
Press **■**.

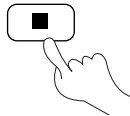

6. Press the **▲** button on the remote control to remove the disc and turn off the unit.
- You have to push "**■**" button twice to stop playback of a DVD disc.

Pause



Press **||**

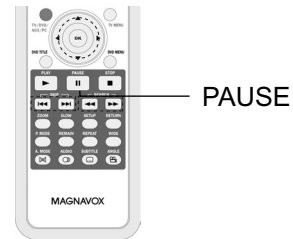

DVD

- To pause playback of a DVD while it is playing, press **||**. The unit enters step play status. Each time you press **||**, the picture advances one frame.

CD

- Press **||** to make playback pause.
Press **▶** (PLAY) to resume playback.

OSD

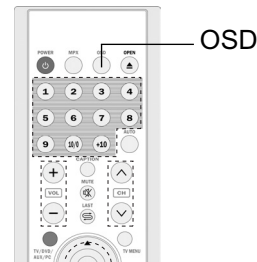
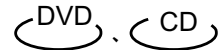

The On-Screen Display (OSD) contains many playback features. To see the Display, press the **OSD** button on the remote while a disc is playing. The picture being played will be zoomed out to the top of the screen. The Display appears under the zoomed picture. Use the **▼** or **▲** buttons on the remote to move through the different playback features in the Display.

When a playback feature is highlighted, press the **▶** (PLAY) button and the text box by the right side of it will be highlight. Use the **▼** or **▲** buttons on the remote to move through the choices displayed in the text box.

BASIC OPERATIONS (FOR DVD PLAYER)

Remember, you can only access the Display when you're playing a disc. Also, the Display features are only available if the disc was created with that particular feature.

The invalid symbol "⊗" appears on the screen when you press a button that doesn't have any function. If one of the playback features is "grayed out", that Display feature isn't available for the disc you're playing.

To make the Display disappear from the screen, press **OSD** on the remote.

WHEN PLAYING DVD

DVD discs have the following playback features: Title, Chapter, Audio, Subtitle, Angle, TT (Title) Time, CH (Chapter) Time, Repeat and Time Display.

■ Select a Title

Some discs contain more than one title. Each title is divided into chapters. To select a title:

1. While the disc is playing, press **OSD** on the remote to bring up the Display.
2. If the Title icon on the Display isn't highlighted, use the ▲ or ▼ buttons to highlight it.
3. Press the ► (PLAY) button, the text box by the right side is now highlighted.
4. Use the number buttons on the remote to enter a title number that you want to play.

Note: Some discs only have one title.

■ Select a Chapter

Because DVD discs use digital technology, a title can be divided into chapters (similar to tracks on a CD). You can skip to a specific chapter by using the Chapter feature in the Display.

1. While the disc is playing, press **OSD** on the remote to bring up the Display.
2. Press the ▲ or ▼ buttons to highlight the Chapter icon.

3. Press the ► (PLAY) button, the text box by the right side is now highlighted.

4. Use the number buttons on the remote to enter a chapter number that you want to play.

Notes: The chapter feature won't work if the disc isn't formatted with separate chapters. You can also advance to the next chapter by pressing ►| on the remote and go to the preceding chapter by pressing ◀◀ on the remote.

■ Changing the Audio Language

If the disc was created with different language tracks (recorded in different languages), you can use the Display to temporarily change the DVD player's Audio Language setting.

1. While the disc is playing, press **OSD** on the remote to bring up the Display.
2. Press the ▲ or ▼ buttons to highlight the Audio icon.
3. Press the ► (PLAY) button, the audio languages appear on the screen.
4. Press the ▲ or ▼ buttons to move through the audio languages that are available on the disc. Press the ► (PLAY) button when the audio language you want to use is highlighted.
5. To make the Display disappear, press the **OSD** button on the remote.

Note: The language feature only works if the disc was created with multiple audio tracks.

When you choose an audio language from the Display, you only override the audio language setting in the DVD player's main menu temporarily.

The audio language can also be changed through the DVD player menu.

■ Selecting the Subtitle Language

If the disc was created with subtitles, you can use the Display to change the Subtitle language.

BASIC OPERATIONS (FOR DVD PLAYER)

1. While the disc is playing, press **OSD** on the remote to bring up the Display.
2. Press the **▲** or **▼** buttons to highlight the "Subtitle".
3. Press the **▶** (PLAY) button, the subtitle languages appear.
4. Press the **▲** or **▼** buttons to move through the subtitle languages that are available on the disc. Press the **▶** (PLAY) button when the subtitle language you want to use is highlighted.
5. To make the Display disappear, press the **OSD** button on the remote.

Notes: Changing the subtitle language with the Display will only affect the disc currently being played. When the disc is removed or the player is turned off, the subtitle language will revert to the language setting specified through the DVD player main menu.

The subtitle language can also be changed through the DVD player menu.

■ Changing the Camera Angle

Some discs contain multiple angles of a particular scene or sequence. When multiple angles are available, to change the camera angle:

1. While the disc is playing, press **OSD** on the remote to bring up the Display.
2. Press the **▲** or **▼** buttons to highlight "Angle".
3. Press the **▶** (PLAY) button, the text box by the right side is now highlighted.
4. Use the number buttons to enter an angle number that you want to play.
5. To make the Display disappear, press the **OSD** button on the remote.

■ Setting Title Time

You can skip to a specific title time by using the Title Time feature in the Display.

1. While the disc is playing, press **OSD** on the remote to bring up the Display.
2. Press the **▲** or **▼** buttons to highlight "TT (Tile) Time" .
3. Press the **▶** (PLAY) button, the text box by the right side is now highlighted.
4. Use the number buttons to enter an angle number that you want to play.

■ Setting Chapter Time

You can skip to a specific chapter time by using the Chapter Time feature in the Display.

1. While the disc is playing, press **OSD** on the remote to bring up the Display.
2. Press the **▲** or **▼** buttons to highlight "CH (Chapter) Time" .
3. Press the **▶** (PLAY) button, the text box by the right side is now highlighted.
4. Use the number buttons to enter an angle number that you want to play.

■ Using the Repeat Feature

The default mode for the Repeat feature is off.

There are three Repeat options:

- All - repeats the disc that is playing
- Title - repeats the title that is playing
- Chapter - repeats the chapter that is playing

To Use Repeat:

1. While the disc is playing, press **OSD** on the remote to bring up the Display.
2. Press the **▲** or **▼** buttons to highlight "Repeat".
3. Press the **▶** (PLAY) button, the repeat options appear.
4. Press the **▲** or **▼** buttons to move through the repeat options. Press the **▶** (PLAY) button when the repeat option you want to use is highlighted.
5. The selected repeat option will loop repeatedly until you turn Repeat off.

BASIC OPERATIONS (FOR DVD PLAYER)

How to Cancel Repeat:

There are three ways to cancel Repeat:

- Press STOP twice.
- Go to Repeat icon in the Display and select Off.
- Eject the disc.

■ Shifting the Displayed Time

Using the Time Display feature in the Display, you can shift the time displayed on the screen, between: Title Elapsed Time, Title Remain Time, Chapter Elapsed Time, and Chapter Remain Time.

1. While the disc is playing, press **OSD** on the remote to bring up the Display.
2. Press the **▲** or **▼** buttons to highlight "Time Disp".
3. Press the **▶** (PLAY) button, the time options appear.
4. Press the **▲** or **▼** buttons to move through the time options. Press the **▶** (PLAY) button when the option you want to use is highlighted.
5. To make the Display disappear, press the **OSD** button on the remote.

WHEN PLAYING CD

CD discs have the following playback features: Track, Disc Time, Track Time, Repeat and Time Display.

■ Select a Specific Track

1. While the disc is playing, press **OSD** on the remote to bring up the Display.
2. Press the **▲** or **▼** buttons to highlight "Track".
3. Press the **▶** (PLAY) button, the text box by the right side is now highlighted.
4. Use the number buttons on the remote to enter a track number that you want to play.

■ Setting Disc Time

You can skip to a specific disc time by using the Disc

Time feature in the Display.

1. While the disc is playing, press **OSD** on the remote to bring up the Display.
2. Press the **▲** or **▼** buttons to highlight "Disc Time", while a disc is playing.
3. Press the **▶** (PLAY) button, the text box by the right side is now highlighted.
4. Use the number buttons on the remote to enter a disc time that you want to play.

■ Setting Track Time

You can skip to a specific track time by using the Track

Time feature in the Display.

1. While the disc is playing, press **OSD** on the remote to bring up the Display.
2. Press the **▲** or **▼** buttons to highlight "Track Time", while a disc is playing.
3. Press the **▶** (PLAY) button, the text box by the right side is now highlighted.
4. Use the number buttons on the remote to enter a track time that you want to play.

■ Using the Repeat Feature

The default mode for the Repeat feature is off.

There are two Repeat options for CDs:

- All - repeats the disc that is playing
- Track - repeats the track that is playing

To use Repeat:

1. While the disc is playing, press **OSD** on the remote to bring up the Display.
2. Press the **▲** or **▼** buttons to highlight "Repeat", while a disc is playing.
3. Press the **▶** (PLAY) button, the repeat options appears.
4. Press the **▲** or **▼** buttons to move through the repeat options. Press the **▶** (PLAY) button when the repeat option you want to use is highlighted.
5. The selected repeat option will loop repeatedly until you turn Repeat off.

■ Shifting the Displayed Time

Using the Time Display feature in the Display, you can shift the time displayed on the screen, between: Single (Track) Elapsed Time, Single (Track) Remain Time, Total (Disc) Elapsed Time, and Total (Disc) Remain Time.

BASIC OPERATIONS (FOR DVD PLAYER)

1. While the disc is playing, press **OSD** on the remote to bring up the Display.
2. Press the **▲** or **▼** buttons to highlight "Time Disp" in the Display while a disc is playing.
3. Press the **▶** (PLAY) button, the time options appears.
4. Press the **▲** or **▼** buttons to move through the time options. Press the **▶** (PLAY) button when the option you want to use is highlighted.
5. To make the Display disappear, press the **OSD** button on the remote.

Volume Control



- Press **VOLUME** on the TV or amplifier to adjust the volume.
- Press **VOLUME** on the remote control.

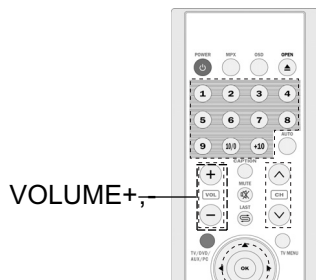

1. Press **+** to raise the volume.

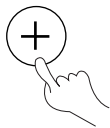

2. Press **-** to lower the volume.

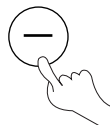

DVD Menu Play

Some DVDs have title menus and chapter menus.

Press **▶** (PLAY), the screen shows the menu. Press **▶▶** or **◀◀** to skip to the next or previous page. Select with number buttons or direction buttons.

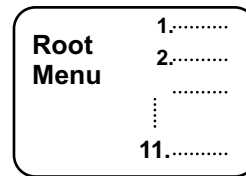

Example: select track 13.

1. Press **▶▶** to enter the next menu.

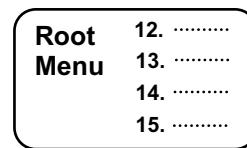

2. Press number buttons to select directly.



You can also select as follows:

1. Press **▼** to select track 13.

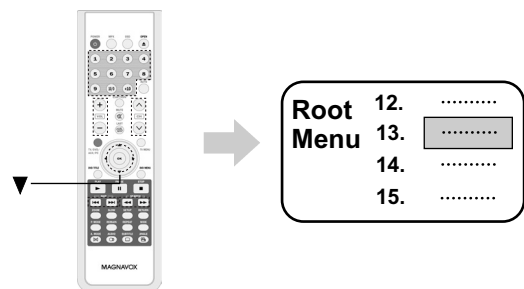

2. Press **▶** (PLAY) to start playing track 13.

Press **DVD TITLE** once to return to the title menu.

Press **DVD MENU** once to return to the root menu; press it again to resume to play.

BASIC OPERATIONS

Select with Number Buttons

Load a disc. Press number buttons to select tracks after the unit finishes reading the disc.

- If the track number isn't over 10, just push buttons 1-10.
Example: push **8** to select track 8.



The screen shows:

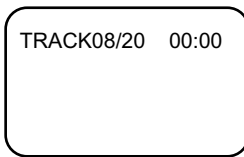

- If the track number is over 10, press **+ 10** once and a button between 1-10.
Example: if you select track 12, press **+10** once and button **2**.



The screen shows:

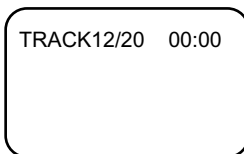

PLAY DISCS IN VARIOUS WAYS

Audio Mode

- You may select a language from a multi-language DVD.
- You may select the right channel, left channel, or stereo options from a multi-channel CD.

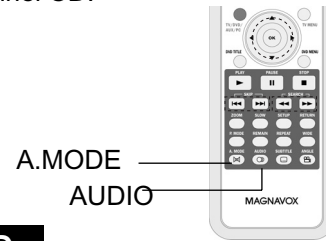

DVD

- To select a language, press **AUDIO**.
The screen will show the following in order:

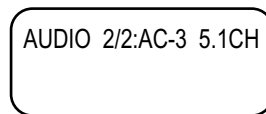
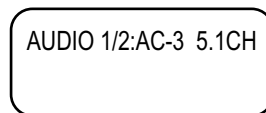

Different discs may differ in languages available.

- To select audio channel option, press **A.MODE**, the screen shows the following in order:

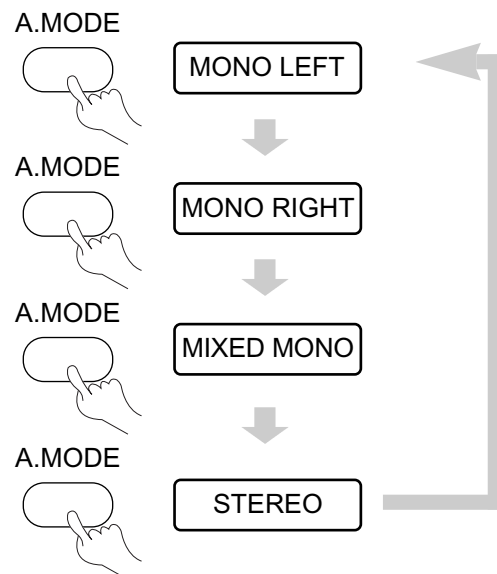

PLAY DISCS IN VARIOUS WAYS

CD

To select audio channel option when for CD playback, press **A.MODE**. The screen will show the following in order:

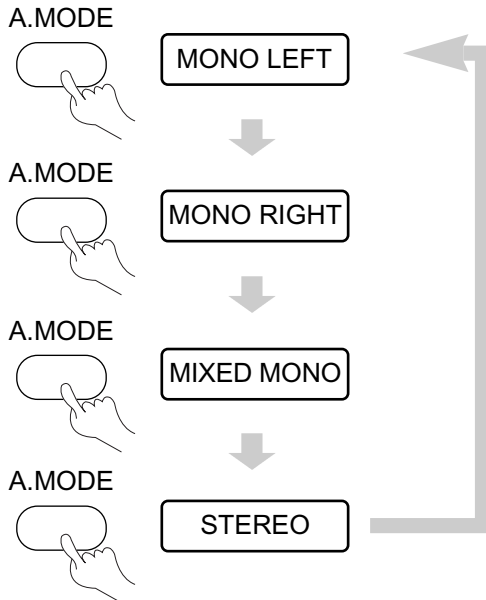

You may select one mode.

Notes:

- Different discs differ in languages available.

Mute



When playing a disc, this function removes the sound.

1. TO REMOVE SOUND

Press **MUTE**, the screen shows "⊗".

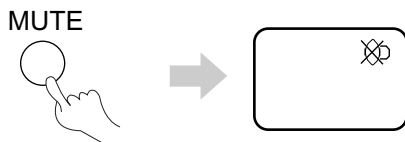

2. TO RESUME SOUND

Press **MUTE** again, to resume sound.

Fast Play

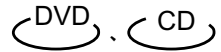

When playing a disc, you can play it in fast-forward or fast-reverse mode to find what you want to view.

DVD OR CD

1. While disc is playing, press **▶▶** to play in fast-forward mode. Each time you press the button, the screen shows the following in order:

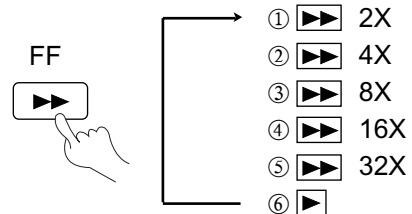

2. While disc is playing, press **◀◀** to play in fast-reverse mode. Each time you press the button, the screen shows the following in order:

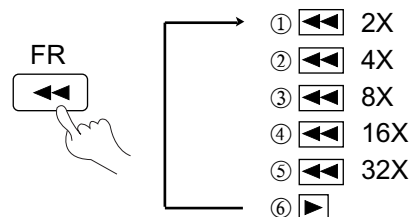

3. Press **▶** (PLAY) to switch to normal play while in fast-forward or fast-reverse playing mode.

PLAY DISCS IN VARIOUS WAYS

Slow Play



Enjoy slow motion by the following the steps below.

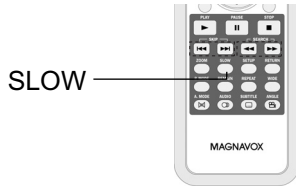

DVD

1. Press **SLOW** to play in slow motion.

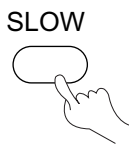

The screen shows the following in order:

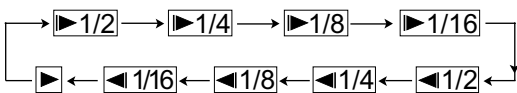

2. Press **▶** (PLAY) to resume play at normal speed.

Repeat Play



This function can be used to repeatedly play a title, chapter, track, or a whole disc.

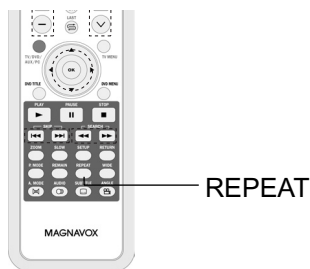

Playing A Disc Repeatedly

DVD

You can repeat a title or chapter.

1. To repeat a chapter:

Press **REPEAT**, the screen will show:

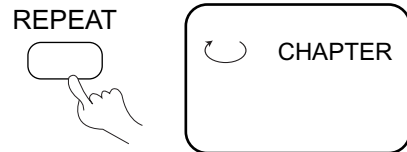

2. To repeat a title:

Press **REPEAT** twice, the screen will show:

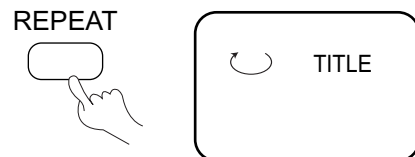

3. To repeat all:

Press **REPEAT** third time, the screen shows " ALL".

4. To remove "REPEAT" function:

Press **REPEAT** until " ALL" disappears.

CD

- You may repeat a track or an entire disc according to the following steps.

1. To repeat a track:

Press **REPEAT**, the screen shows " TRACK".

The unit plays the current track.

PLAY DISCS IN VARIOUS WAYS

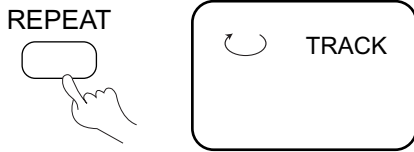

2. To repeat a disc:

Press **REPEAT** , the screen shows " ALL".

The unit plays all the tracks on the disc.

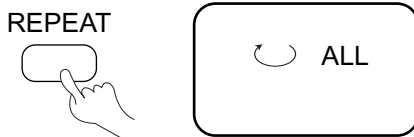

3. To remove "REPEAT" function:

Press **REPEAT** till " ALL" disappears.

Zoom Play

This function can be used to watch a motion or motionless picture.

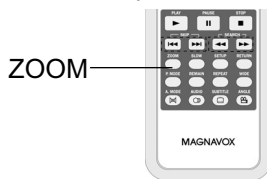

1. Press **ZOOM** during playback, the screen shows:

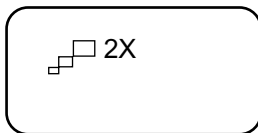

The picture is enlarged twice the size.

2. Press **ZOOM** again, the screen shows:

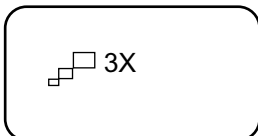

The picture is enlarged three times the size.

Note: The unit has six zoom levels:

2X, 3X, 4X, 1/2 , 1/3 , and 1/4 .

3. Press **◀**, **▲**, **▼**, **▶** to move the enlarged picture.

4. To resume the picture, press **ZOOM** until the picture is in normal size.

Select Subtitles



This operation works only with discs with multiple subtitle languages recorded.

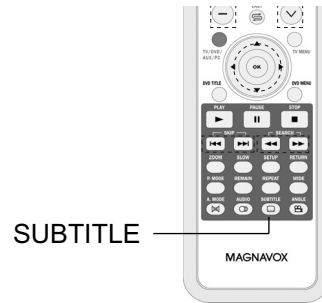

DVD

1. Press **SUBTITLE** repeatedly until the desired language is selected.

The screen shows:

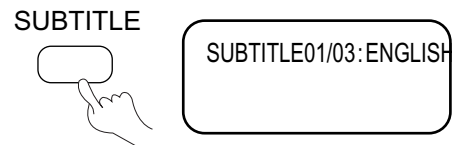

2. Remove the subtitle.

Press **SUBTITLE** until the screen shows "SUBTITLE OFF".

Notes:

- For some discs, subtitles cannot be removed.
- Different discs differ in the language of subtitles.
- If the subtitles of discs cannot be selected, the screen shows " " when you press **SUBTITLE** .

PLAY DISCS IN VARIOUS WAYS

Angles Select

Some discs have images with different viewing angles, you may select among them. For example, when you watch a running train, you may watch it from the front, the left window or the right window without stopping it.

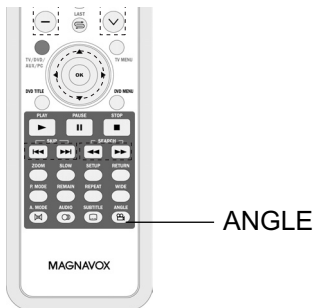



Example:

A DVD has four viewing angles at your option.

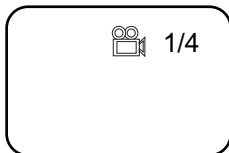
1. Press **ANGLE** to select ANGLE1.



2. Press **ANGLE** to select other angles, the screen shows respectively:

-  2/4 (select ANGLE2)
-  3/4 (select ANGLE3)
-  4/4 (select ANGLE4)

3. To resume normal playback, press **ANGLE** to select original angle.

Program Play

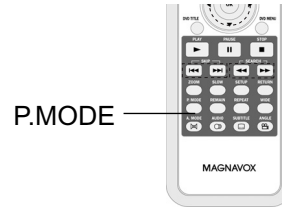

To use the program playback feature, you must enter the order in which you want the titles (and chapters) on the DVD or the tracks on the CD to play by creating a program.

DVD

1. Press **P.MODE** until the screen shows:

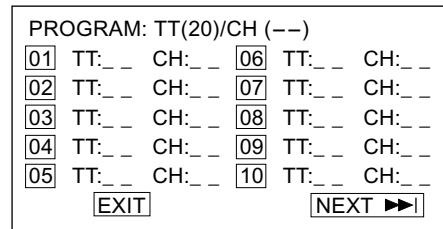

2. Use the number buttons on the remote to enter the title (and chapter) you want to play first. The title (and chapter) number you entered appears in the box. For example: Enter Chapter 1 in Title 8, the screen shows:

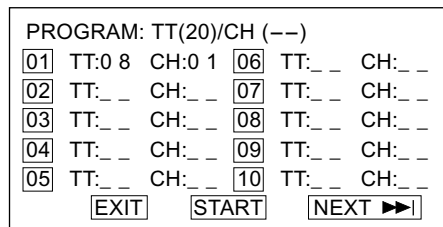

3. The cursor jumps to the next spot in the program list section. Make sure the box is highlighted and enter your next track.
4. Continue adding title (and chapter) until your program is complete. You can play your program by highlighting **START** and press **PLAY**.

Note: If you want to program more than 10 titles (and chapters), highlight **NEXT** and press **PLAY** to go to the next page. Proceed to program 11-20 in the same way titles 1-10 were programmed.

5. To remove program playback, press the **STOP** button twice during the program play.

PLAY DISCS IN VARIOUS WAYS

CD

1. Press **P.MODE** until the screen shows:

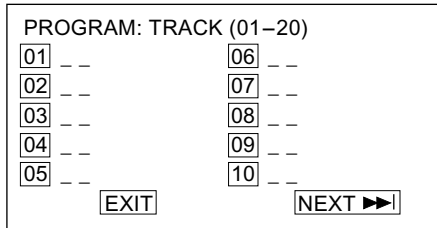

2. Use the number buttons on the remote to enter the track number you want to play first. The track number entered appears in the box. The example: To program track 8 of a CD to play first, enter 8, and the screen shows:

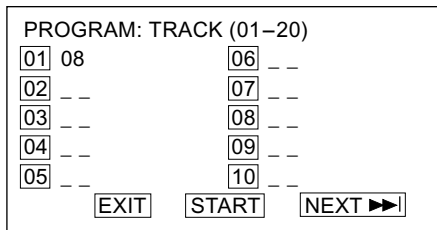

- The cursor jumps to the next spot in the program list section. Make sure the box is highlighted and enter your next track.
- Continue adding tracks until your program is complete. You can play your program by highlighting **START** and press **PLAY**.

Note: If you want to program more than 10 tracks, highlight **NEXT** and press **PLAY** to go to next page. Program 11-20 in the same way 1-10 were programmed.

5. To remove program playback, press the **STOP** button during the program play.

Shuffle (Random) Play



The unit can play DVD chapters or audio tracks in random order.

The order is different each time.

- Press **P.MODE** to select shuffle or random play mode when a disc is playing.

P.MODE



The screen shows:

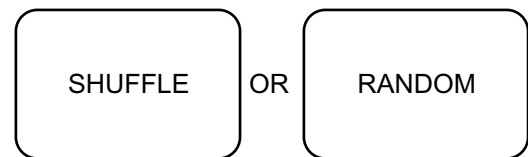

- Shuffle or random play will begin.
- Remove shuffle or random play.
 - When playing a DVD disc, press **■** twice.
 - When playing a CD disc, press **■** twice.

MENU SETTING

According to the recorded information and external equipment, set the following functions for the player to obtain the best playing status.

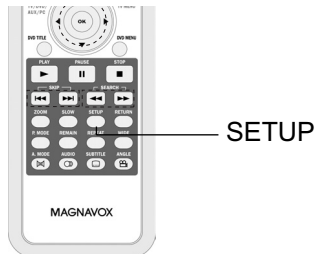

1. Press **SETUP** to set options in the main menu.

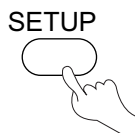

The main menu appears on the screen, with icons across the top of the screen, illustrating General Setup, Audio Setup, Preference Setup, Password Setup, and Exit Setup. The screen shows:

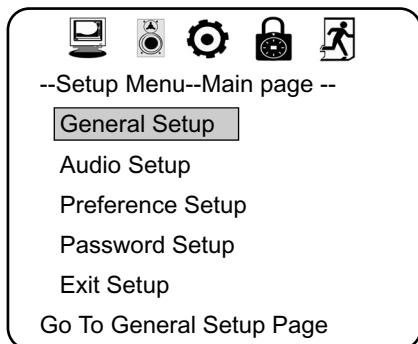

2. Press direction buttons (▼ or ▲) to select and press ► (PLAY) to confirm.

Example: Select "Audio Setup" and do some setup.

- Press direction button ▼ to highlight "Audio Setup", press ► (PLAY) to enter "Audio Setup Page".

The screen shows:



- Press direction buttons (▼ or ▲) to highlight "Dolby Digital Setup", and press ► (PLAY) to enter "Dolby Digital Setup" Page. The screen shows the submenu for your selection.

The screen shows:

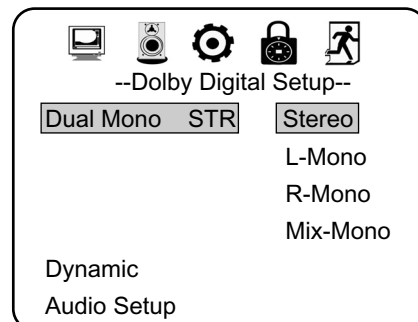

- Press direction buttons ►, ▼ to select "L-Mono".

The screen shows:

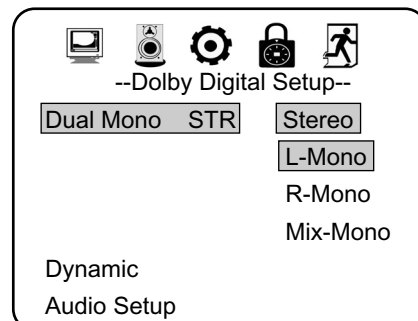

MENU SETTING

- Press ► (PLAY) to confirm your selection.
Set "Dual Mono" in "Dolby Digital Setup" to "L-Mono".

The screen shows:

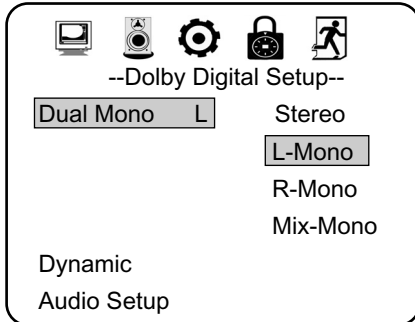

3. Exit setup menu.

- Press the direction button ◀ to exit from "Dual Mono".
- Press the direction button ◀ to exit from "Dolby Digital Setup".
- Press the direction button ▼ to highlight "Main Page" and press ► (PLAY). The screen shows:

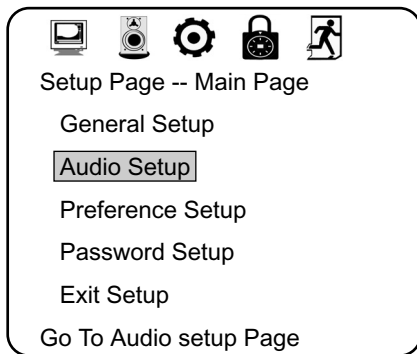

- Press the direction button ▼ to highlight "Exit Setup" and press ► (PLAY) to exit setup menu completely.

NOTE: You can also keep pressing the direction button ◀ until the cursor is moved to the last icon illustrating Exit, then press the ► (PLAY) button to exit setup menu completely.

General Setup

The setting structure is :

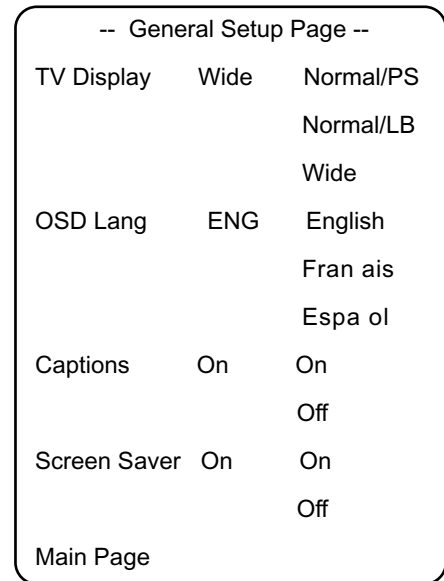

■ TV DISPLAY

1. NORMAL/PS

This is selected when the unit is connected to a normal TV.

Wide-screen images are shown on the screen, but with some parts cut automatically.



2. NORMAL/LB

This is selected when the unit is connected to a normal TV. Wide-screen images are shown on the screen with black bars on the top and bottom of the screen.



3. WIDE

This is selected when the unit is connected to a wide-screen TV.

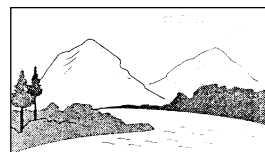

NOTE: You can use the **WIDE** button on the remote control to set TV display mode.

MENU SETTING

■ OSD LANGUAGE

- ENGLISH
The OSD is in English.
- FRENCH
The OSD is in French.
- SPANISH
The OSD is in Spanish.

■ CAPTIONS

- ON
Subtitles are shown.
- OFF
Subtitles are hidden.

■ SCREEN SAVER

The screen saver image appears when the unit stops or the image is frozen for a few minutes. The screen saver prevents damage to the TV screen.

- ON: Start the screen saver.
- OFF: Remove the screen saver.

Audio Setup

The setting structure is:

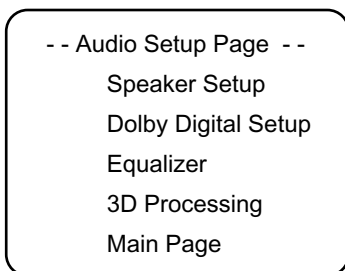

■ SPEAKER SETUP

The setting structure is:

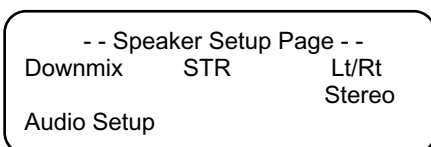

- Lt/Rt
A disc recorded multi channel soundtrack, the output signal will be incorporated to left and right channel.
- STEREO
A disc recorded multi channel soundtrack, the output signal will be incorporated to stereo.

■ DOLBY DIGITAL SETUP

The setting structure is:

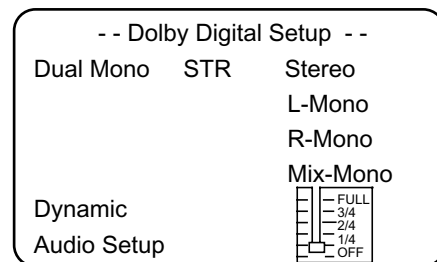

- DUAL MONO
This is the output mode of the L and R signals of the set audio output. If it is set to "MIX-MONO", the function only works when the DVD being played is 5.1-channel.
- Dynamic
This is selected to adjust linear compression rate to obtain the different compression results of the signals.

■ EQUALIZER

This will help you to select graphic equalizer patterns according to the genre of the music being played, and adjust the equalizer.

The setting structure is:

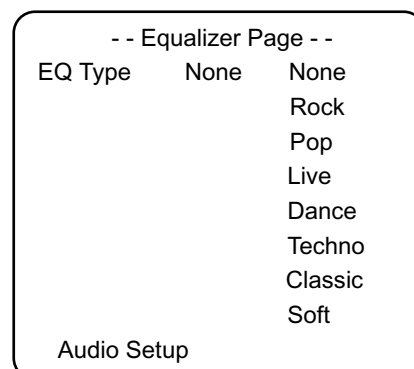

- EQ TYPE
You can select music category by pressing the direction buttons and confirm by pressing the **PLAY** button.

MENU SETTING

■ 3D PROCESSING

The setting structure is:

-- 3D Processing Page --

V SURR	Off	On
		Off
Reverb Mode	Off	Off
		Concert
		Living Room
		Hall
		Bathroom
		Cave
		Arena
		Church

Audio Setup

- V SURR

Use to turn the above function off.

- REVERB MODE

Use to select a Reverb Mode which you want.

Password Setup

The setting structure is :

-- Password Setup Page --

PW Mode	Off	On
		Off
Password		Change
Main Page		

■ PASSWORD MODE

- ON: The password function is on and "PARENTAL" is dim and cannot be selected.
- OFF: The password is locked, "PARENTAL" can be selected.

■ PASSWORD CHANGE

Select this to adapt the code, the screen shows:

Old Password	<input type="text"/>
New Password	<input type="text"/>
Confirm PWD	<input type="text"/>
	<input type="button" value="OK"/>

Enter a password according to the screen.

Note: The password is automatically factory set to 99999.

MENU SETTING

Preferences

The setting structure is :

-- Preference Page --		
Audio	ENG	English French Spanish Chinese Japanese
Subtitle	ENG	English French Spanish Chinese Japanese Off
Disc Menu	ENG	English French Spanish Chinese Japanese
Parental	08	1 KID SAFE 2 G 3 PG 4 PG 13 5 PGR 6 R 7 NC17 8 ADULT
Default		Reset
Main Page		

■ LANGUAGE SELECTION

If a language mentioned above is recorded on the disc, you can select sound, subtitles or disc menu languages. If not, the language recorded on the disc is shown.

■ PARENTAL LOCK

When playing a disc with parental lock function, you may select an age control grade according to the rating your desire.

Example: If "PG" is selected, you cannot play DVD video discs rated higher than the PG grade.

■ DEFAULT >> RESET

Each function setting returns to the initial status in the factory if you select this option.

Note:

- "PREFERENCES" can only be selected when password is OFF when the unit is in stop mode.

KODAK PICTURE CD PLAYBACK

A Kodak Picture CD has the size and shape of a regular CD. You can order a KODAK Picture CD simply by checking the box on the photofinishing envelope when you drop off a roll of film (35 mm or Advanced Photo System (APS) color print film) at the time of processing in photo processing outlet displaying "Kodak Picture CD" sign. When your order is returned, you receive your prints, negatives, and your full roll of pictures safely stored on your KODAK Picture CD. Each KODAK Picture CD brings you the tools to enhance, share and manage your pictures on your computer.

Now, you can playback Kodak Picture CDs on XXX DVD players and view your pictures on your TV in the comfort of your living room.

Playing back your Kodak Picture CD

The new feature enables the decoding of JPEG files from a Kodak Picture CD disk.

Playback modes

Normal

When a Kodak Picture CD is inserted on a player an automatic slide show is launched. Each picture in the Kodak Picture CD will be displayed consecutively in a slide-show fashion and will be scaled to fit in the TV screen. Twelve slideshow transition modes are provided, use "P. MODE" key to select. Select transition mode prior to start of slideshow if one mode is desired for the entire show.

Mode 0: no special transition effect (by default)	Mode 8: wipe from right bottom to left top
Mode 1: wipe from top to bottom	Mode 9: wipe from center to top/bottom
Mode 2: wipe from bottom to top	Mode 10: wipe from center to left/right
Mode 3: wipe from left to right	Mode 11: wipe from top/bottom to center
Mode 4: wipe from right to left	Mode 12: wipe from left/right to center
Mode 5: wipe from left top to right bottom	Mode 13: horizontal blinds
Mode 6: wipe from right top to left bottom	Mode 14: vertical blind
Mode 7: wipe from left bottom to right top	Mode 15: wipe from edge to center
	Mode 16: random

Customer can set transition effects for each picture in a slideshow by using the "P. MODE" functions while viewing a slideshow. The last transition mode selected will be used in any future slideshows.

To display an image indefinitely, press the PAUSE key. To view the Next or Previous picture press NEXT or PREVIOUS keys. To resume the slideshow press the PLAY key.

Image Rotation

There are four modes to rotate a picture: "Invert", "Mirror", "Left", and "Right". These operations are allowed only when a picture is being displayed normally and will be cancelled automatically when a new picture is displayed. The arrow key is used to select the different rotation modes:

Up	▲	-Invert/Normal
Down	▼	-Mirror/Normal
Left	◀	-Turn left
Right	▶	-Turn right

Zoom

We provide both ZOOM in/out and Zoom pan function for the pictures. The "ZOOM" key is used to turn on or off this function. When this mode is on, any picture will be displayed at the last ratio selected by the user. A message on the screen will indicate the current Zoom ratio.

If zoom mode is on, "FF" and "FR" keys are used to control the ratio of zoom in/out. With ZOOM mode off, a picture is scaled to fit the TV screen.

Notes: During ZOOM function, slideshow transition and image rotation are disabled. TO cancel the ZOOM function, press the ZOOM key again and resume the slideshow.

Digest

The "MENU" or "STOP" key is used to display thumbnail size pictures. After it is enabled, up to 9 scaled-down thumbnail pictures will be displayed on the screen. The "NEXT" and "PREV" keys can be used to display the next/prev nine pictures in the the Kodak Picture CD.

You can select any of the nine displayed thumbnails by using the Arrow Keys and pressing the "PLAY" key. The thumbnail will be enlarged to fit the TV screen and the slide show will start. If you desire to display an image indefinitely, press the PAUSE key. To view the Next or Previous picture press NEXT or PREVIOUS keys. To resume the slideshow press the PLAY key.

IMPORTANT NOTE:

Quality of pictures displayed on the screen is highly dependent on the viewing device.

TROUBLESHOOTING -- WATCHING TV

Please check the following items before asking for repair service.

Symptom	Check Items
Neither picture nor sound.	<ul style="list-style-type: none">• Check the contact of sockets is all right.• Check the TV main power is on.
Picture is OK, but no sound.	<ul style="list-style-type: none">• Check the volume control is set to minimum or mute.
Sound is OK, but no color.	<ul style="list-style-type: none">• Check the color control and adjust it properly.• Check the programme is in color or in black & white.
The picture is overlapped image.	<ul style="list-style-type: none">• Check the antenna is installed correctly and if not, adjust the antenna toward the broadcasting station.• Check the "FINE TUNE "is set up correctly and if not, adjust the fine tuning properly.
Picture has "snow noise ".	<ul style="list-style-type: none">• Check the antenna or its connection is correct and if not, correct the antenna fault or connection cable fault.• Check if car traffic or neon sign disturbs the sound effect.
Stripes on picture.	<ul style="list-style-type: none">• Check the susceptible interference by other electronic devices such as radio and television and keep magnetic or electronic devices away from the TV.
Bad stereo or SAP sound.	<ul style="list-style-type: none">• Long distance from the station or other radio waves can generate bad sound. Reception. If so, change the mode to Mono.
Remote control does not work.	<ul style="list-style-type: none">• Check if the batteries in the Remote control die.• Check if any object between IR sensor of the TV and the Remote control does not obstruct.
"Out Of Range" appears on the screen.	<ul style="list-style-type: none">• Check the resolution and frequency of your PC. Then, adjust them to optimum condition for LCD TV: 1280X768 and 60Hz.• Refer to the table of PC mode input format indicated on page 15. (Not being registered resolution and frequency on the table won't be displayed.)
"No Signal" appears on the screen.	<ul style="list-style-type: none">• Ensure that the signal cable is firmly connected to PC and TV.
Image is not clear in PC mode.	<ul style="list-style-type: none">• Adjust the PHASE control. (Refer to the PICTURE ADJUSTMENT.)
Image is not centered.	<ul style="list-style-type: none">• Adjust the H-POSITION, and IMAGE SIZE Control. (Refer to the WINDOW ADJUSTMENT.)

TROUBLESHOOTING — WATCHING DVD

If you experience the following problems while using the unit, this troubleshooting guide can help you.

No sound

- Check if the unit is connected securely.
- Make sure the TV or amplifier is working properly.
- Make sure the amplifier is set to receive DVD signal output.

No image

- Check if the unit is connected securely.
- Make sure the TV is working properly.
- Make sure the color system is set correctly.

Bad sound quality

- Make sure the audio output mode is set correctly.
- Make sure the audio connection between the unit and amplifier is in place.

Disc cannot be played

- There is no disc in the unit.
- Put the disc on the disc tray properly with the label side up.
- Clean the disc.
- Moisture has condensed in the unit. Remove the disc and leave the unit on for about an hour.

The unit doesn't operate normally

- Disconnect the power plug and insert it into the wall outlet again.

Remote control does not work

- Remove barriers between the remote control and the unit.
- Point the remote control at the remote control sensor of the unit.
- Replace the batteries with new ones.

This product incorporates copyright protection technology that is protected by method claims of certain U.S. patents and other intellectual property rights owned by Macrovision Corporation and other rights owners. Use of this copyright protection technology must be authorized by Macrovision Corporation, and is intended for home and other limited viewing uses only unless otherwise authorized by Macrovision Corporation. Reverse engineering or disassembly is prohibited.

TECHNICAL SPECIFICATIONS

LCD

- PANEL 26" WIDE TFT LCD
- RESOLUTION 1280 X 768 X RGB
- ACTIVE AREA (mm) 370 X 222
- VIEWING ANGLE (° ,H/V) 176/176

DIMENSION

- WITH STAND (mm) 770 X 552 X 210
- WITHOUT STAND (mm) 770 X 443 X 100

- WEIGHT (WITHOUT ACCESSORIES) 15.8kg

TV-FUNCTION

- TV STANDARD NTSC
- TUNING SYSTEM ELECTRIC TUNING SYSTEM
- FREQUENCY RANGE VHF/UHF
- STEREO MTS + SAP
- CATV 125 CHANNELS

SOUND

- SOUND OUTPUT 8W × 2

TERMINALS

- AV IN VIDEO, S-VIDEO, AUDIO L&R
- COMPONENT Y, Pb (Cb), Pr (Cr)
- MONITOR OUT VIDEO OUT
- PC IN D-SUB 15PIN RGB IN, DVI
- ANTENNA IN F-TYPE

DVD

- Applicable disc DVD/CD-R/CD-RW/CD/MP3/Picture CD

Power adapter

- Output DC 24Volt, 6.0 Ampere
- Input 100~240Volt

Power consumption

- Power consumption (TV) 130 Watt
- Power consumption (DVD) ≤ 130 Watt

This manual is only for your reference, any change to the design and specifications will not be advised.



REGULATORY

FEDERAL COMMUNICATIONS COMMISSION (FCC) NOTICE (U.S. ONLY)

	<p>This equipment has been tested and found to comply with the limits for a Class B digital device, pursuant to Part 15 of the FCC Rules. These limits are designed to provide reasonable protection against harmful interference in a residential installation. This equipment generates, uses and can radiate radio frequency energy and, if not installed and used in accordance with the instructions, may cause harmful interference to radio communications. However, there is no guarantee that interference will not occur in a particular installation. If this equipment does cause harmful interference to radio or television reception, which can be determined by turning the equipment off and on, the user is encouraged to try to correct the interference by one or more of the following measures:</p>
---	---

- Reorient or relocate the receiving antenna.
- Increase the separation between the equipment and receiver.
- Connect the equipment into an outlet on a circuit different from that to which the receiver is connected.
- Consult the dealer or an experienced radio/TV technician for help.

	<p>Changes or modifications not expressly approved by the party responsible for compliance could void the user's authority to operate the equipment.</p>
---	--

Use only RF shielded cable with ferrite core when connecting this monitor to a computer device.

- RF shield cable with ferrite core can be obtained from multiple retail outlets or Philips Factory Service Center.
- The RF shield cable with ferrite core part number is 3138 198 71441.
- If your RF shield cable without ferrite core, you can obtain the ferrite core from Philips Factory Service Center; installation as following.

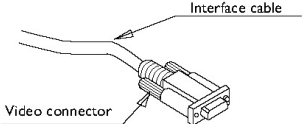
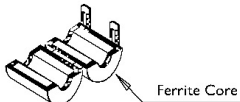
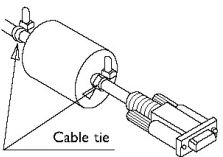
1. Open the ferrite core.
2. Locate the video connector that goes to the computer and plugs into the unit. Place the ferrite core as close to the video connector as possible, as shown in the figure below.

3. Lock the ferrite core.

4. Place two cable tie wrap on either side of the ferrite core to prevent it from sliding down the cable, as shown in the figure below.

5. Draw the tie wraps tight and cut off the excess leads.

Ferrite Core Installation

To ensure compliance of this unit to the Class B limits of the FCC Rules, Part 15, Subpart B.

This kit must be utilized when "non-ferrited" video cables are used with this unit. This instruction sheet gives the details for proper installation.

Additional FCC information may be found in the radio frequency interference statement located in the user's manual.

To prevent damage which may result in fire or shock hazard, do not expose this appliance to rain or excessive moisture.
THIS CLASS B DIGITAL APPARATUS MEETS ALL REQUIREMENTS OF THE CANADIAN INTERFERENCE-CAUSING EQUIPMENT REGULATIONS.



COMMISSION FEDERALE DE LA COMMUNICATION (FCC DECLARATION)

	<p>Cet équipement a été testé et déclaré conforme aux limites des appareils numériques de class B, aux termes de l'article 15 Des règles de la FCC. Ces limites sont conçues de façon à fournir une protection raisonnable contre les interférences nuisibles dans le cadre d'une installation résidentielle. CET appareil produit, utilise et peut émettre des hyperfréquences qui, si l'appareil n'est pas installé et utilisé selon les consignes données, peuvent causer des interférences nuisibles aux communications radio. Cependant, rien ne peut garantir l'absence d'interférences dans le cadre d'une installation particulière. Si cet appareil est la cause d'interférences nuisibles pour la réception des signaux de radio ou de télévision, ce qui peut être décelé en fermant l'équipement, puis en le remettant en fonction, l'utilisateur pourrait essayer de corriger la situation en prenant les mesures suivantes:</p>
--	---

- Réorienter ou déplacer l'antenne de réception.
- Augmenter la distance entre l'équipement et le récepteur.
- Brancher l'équipement sur un autre circuit que celui utilisé par le récepteur.
- Demander l'aide du marchand ou d'un technicien chevronné en radio/télévision.

	<p>Toutes modifications n'ayant pas reçu l'approbation des services compétents en matière de conformité est susceptible d'interdire à l'utilisateur l'usage du présent équipement.</p>
--	--

N'utiliser que des câbles RF blindés avec ame en ferrite pour les connections avec des ordinateurs ou périphériques.

- Vous pouvez vous procurer le câble de blindage RF avec tore magnétique dans les différents magasins de détails ou au centre de service d'usine Phillips.
- Le numéro de pièce du câble de blindage RF avec tore magnétique est 3138 198 71441.
- Si votre câble de blindage RF ne possède pas de tore magnétique, vous pouvez l'obtenir auprès du centre de service d'usine Phillips. Suivez les instructions ci-dessous pour l'installation.

1. Ouvrez le tore magnétique.
2. Localisez le connecteur d'écran allant dans l'ordinateur et se branchant dans l'unité. Placez le tore magnétique aussi près possible du connecteur d'écran comme illustré dans la figure ci-dessous.

3. Verrouillez le tore magnétique.
4. Placez deux attaches à tête d'équerre de câble sur l'un des deux côtés du tore magnétique pour l'empêcher de glisser le long du câble, comme illustré ci-dessous.

5. Tirez les attaches à tête d'équerre pour enlever le surplus des broches de raccordement.

Installation du tore magnétique

Pour assurer la conformité de cette unité avec les limites de la Classe B des règlements de la FCC, partie 15, sous-partie B.

Cet ensemble doit être utilisé lorsque des câbles vidéo « sans magnétisme » sont utilisés avec cette unité. Cette feuille d'instructions vous donne les détails concernant l'installation adéquate.

Des renseignements FCC additionnels peuvent être trouvés dans l'énoncé d'interférence des radiofréquences contenus dans le manuel de l'utilisateur.

CET APPAREIL NUMERIQUE DE LA CLASSE B RESPECTE TOUTES LES EXIGENCES DU REGLEMENT SUR LE MATERIEL BROUILLEUR DU CANADA.

Warranty Page

Ninety (90) Days Free Product Exchange

MAGNAVOX warrants this product against defect in material or workmanship, subject to any conditions set forth as follows:

PROOF OF PURCHASE:

You must have proof of the date of purchase to exchange the product. A sales receipt or other document showing the product and the date that you purchased the product as well as the authorized retailer included, is considered such proof.

COVERAGE:

Warranty coverage begins the day you buy the product. For a period of ninety (90) days from the date of purchase, if the product is determined to be defective, Magnavox will exchange the defective product with a new or renewed product, at its option, at no charge. The replacement product is covered only for the warranty period of the original product. When the warranty on the original product expires, the warranty on all replaced products also expires. When it is necessary for you to ship the product to Magnavox for exchange, you will pay the shipping cost for shipment to Magnavox. Magnavox will pay the shipping costs when returning a product to you.

Note: The exchange model supplied will be the most comparable one in Magnavox current inventory. Shipping of your product to Magnavox implies intent to follow the specified requirements of the warranty and exchange program. Product received by Magnavox cannot be returned. Replacement product can only be sent if all warranty requirements are met. Failure to follow all requirements can result in delay of exchange process.

EXCLUDED FROM WARRANTY COVERAGE

Your warranty does not cover:

- Shipping charges to return defective product.
- Labor charges for installation or setup of the product, adjustment of customer controls on the product, and installation or repair of antenna systems outside of the product.
- Product repair and/or part replacement because of improper installation, connections to improper voltage supply, abuse, neglect, misuse, accident, unauthorized repair or other cause not within the control of Magnavox.
- A product that requires modification or adaptation to enable it to operate in any country other than the country for which it was designed, manufactured, approved and/or authorized, or repair of products damaged by these modifications.
- Damage occurring to product during shipping when improperly packaged or cost associated with packaging.
- Product lost in shipment and no signature verification of receipt can be provided.
- A product used for commercial or institutional purposes (including but not limited to rental purposes).
- Product sold AS IS or RENEWED.

This warranty gives you specific legal rights. You may have other rights which vary from state/province to state/province.

WHERE WARRANTY EXCHANGE IS AVAILABLE:

Exchange is available in all countries where Magnavox officially distributes the product. In countries where Magnavox does not distribute the product, the local Magnavox organization will attempt to exchange the product, although there may be a delay if the appropriate product is not readily available or special customs processes are implied.

FOR EXCHANGE IN THE U.S.A., PUERTO RICO, OR U.S. VIRGIN ISLANDS

Contact Magnavox Customer Care Center at:
1-800-705-2000

FPR EXCHANGE IN CANADA...

1-800-661-6162 (French Speaking)
1-800-705-2000 (English or Spanish Speaking)

REPLACEMENT AS PROVIDED UNDER THIS WARRANTY IS THE EXCLUSIVE REMEDY FOR THE CONSUMER. MAGNAVOX SHALL NOT BE LIABLE FOR ANY INCIDENTAL OR CONSEQUENTIAL DAMAGES FOR BREACH OF ANY EXPRESS OR IMPLIED WARRANTY ON THIS PRODUCT. EXCEPT TO THE EXTENT PROHIBITED BY APPLICABLE LAW, ANY IMPLIED WARRANTY OF MERCHANTABILITY OR FITNESS FOR A PARTICULAR PURPOSE ON THIS PRODUCT IS LIMITED IN DURATION TO THE DURATION OF THIS WARRANTY.

Some states do not allow the exclusions or limitation of incidental or consequential damages, or allow limitations on how long an implied warranty lasts, so the above limitations or exclusions may not apply to you. In addition, if you enter into a service contract agreement with the MAGNAVOX partnership within ninety (90) days of the date of sale, the limitation on how long an implied warranty lasts does not apply.

Free Manuals Download Website

<http://myh66.com>

<http://usermanuals.us>

<http://www.somanuals.com>

<http://www.4manuals.cc>

<http://www.manual-lib.com>

<http://www.404manual.com>

<http://www.luxmanual.com>

<http://aubethermostatmanual.com>

Golf course search by state

<http://golfingnear.com>

Email search by domain

<http://emailbydomain.com>

Auto manuals search

<http://auto.somanuals.com>

TV manuals search

<http://tv.somanuals.com>