

# MAGNAVOX

AZ 7351 Portable Compact Disc Player

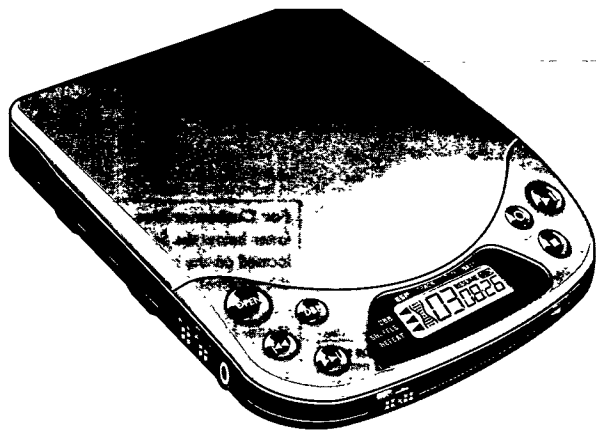

Owner's Manual

**Toll Free Help Line**

Ligne d'assistance en service libre  
Línea de ayuda telefónica sin cargo

**800-531-0039**



Return your Warranty Registration card today to ensure you receive all the benefits you're entitled to.

- Once your MAGNAVOX purchase is registered, you're eligible to receive all the privileges of owning a MAGNAVOX product.
- So complete and return the Warranty Registration Card enclosed with your purchase at once. And take advantage of these important benefits.

### Warranty Verification

Registering your product within 10 days confirms your right to maximum protection under the terms and conditions of your MAGNAVOX warranty.

### Owner Confirmation

Your completed Warranty Registration Card serves as verification of ownership in the event of product theft or loss.

### Model Registration

Returning your Warranty Registration Card right away guarantees you'll receive all the information and special offers which you qualify for as the owner of your model.

Know these  
*safety symbols*

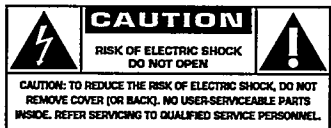

 This "bolt of lightning" indicates uninsulated material within your unit may cause an electrical shock. For the safety of everyone in your household, please do not remove product covering.

 The "exclamation point" calls attention to features for which you should read the enclosed literature closely to prevent operating and maintenance problems.

#### For Customer Use

Enter below the Serial No. which is located on the rear of the cabinet. Retain this information for future reference.

Model No. \_\_\_\_\_

Serial No. \_\_\_\_\_

**WARNING:** TO PREVENT FIRE OR SHOCK HAZARD, DO NOT EXPOSE THIS EQUIPMENT TO RAIN OR MOISTURE.

**CAUTION:** To prevent electric shock, match wide blade of plug to wide slot, and fully insert.

MAC5097

Introduction .....	4
Safety Instructions.....	5
Controls.....	6/7
Connections, Accessories .....	8
Power Supply.....	9
Operation .....	10/12
General Information.....	13
Troubleshooting.....	14/15
Limited Warranty.....	16/17

## Canada

### English:

This digital apparatus does not exceed the Class B limits for radio noise emissions from digital apparatus as set out in the Radio Interference Regulations of the Canadian Department of Communications.

### Français:

Cet appareil numérique n'émet pas de bruits radioélectriques dépassant les limites applicables aux appareils numériques de Classe B prescrites dans le Règlement sur le Brouillage Radioélectrique édicté par le Ministère des Communications du Canada.

## Mexico



Es necesario que lea cuidadosamente su instructivo de manejo.

	<b>PRECAUCIÓN - ADVERTENCIA</b>	
	No abrir, riesgo de choque eléctrico	
<b>ATENCIÓN</b>		
Verifique que el voltaje de alimentación sea el requerido para su aparato		
Para evitar el riesgo de choque eléctrico, no quite la tapa. En caso de requerir servicio, dirijase al personal calificado.		

**MAGNAVOX**  
Smart. *Very smart.*°



***Congratulations on your purchase,  
and welcome to the "family!"***

**Dear MAGNAVOX product owner:**

Thank you for your confidence in MAGNAVOX. You've selected one of the best-built, best-backed products available today. And we'll do everything in our power to keep you happy with your purchase for many years to come.

As a member of the MAGNAVOX "family," you're entitled to protection by one of the most comprehensive warranties and outstanding service networks in the industry.

What's more, your purchase guarantees you'll receive all the information and special offers for which you qualify, plus easy access to accessories from our convenient home shopping network.

And most importantly you can count on our uncompromising commitment to your total satisfaction.

All of this is our way of saying welcome—and thanks for investing in a MAGNAVOX product.

Sincerely,

A handwritten signature in black ink, appearing to read "Robert Minkhorst".

**Robert Minkhorst**  
President and Chief Executive Officer

**P.S. Remember, to get the most from your MAGNAVOX product, you must return your Warranty Registration Card within 10 days. So please mail it to us right now!**

# Read before operating equipment - SAFETY INSTRUCTIONS

This product was designed and manufactured to meet strict quality and safety standards. There are, however, some installation and operation precautions of which you should be particularly aware.

- 1. Read Instructions** - All the safety and operating instructions should be read before the appliance is operated.
- 2. Retain Instructions** - The safety and operating instructions should be retained for future reference.
- 3. Heed Warnings** - All warnings on the appliance and in the operating instructions should be adhered to.
- 4. Follow Instructions** - All operating and use instructions should be followed.
- 5. Water and Moisture** - The appliance should not be used near water - for example, near a bathtub, washbowl, kitchen sink, laundry tub or swimming pool, or in a wet basement, etc.
- 6. Carts and Stands** - The appliance should be used only with a cart or stand that is recommended by the manufacturer.
- 6A.**  An appliance and cart combination should be moved with care. Quick stops, excessive force, and uneven surfaces may cause the appliance and cart combination to overturn.
- 7. Wall or Ceiling Mounting** - The appliance should be mounted to a wall or ceiling only as recommended by the manufacturer.
- 8. Ventilation** - The appliance should be situated so that its location or position does not interfere with its proper ventilation. For example, the appliance should not be situated on a bed, sofa, rug, or similar surface that may block the ventilation openings or placed in a built-in installation, such as a bookcase or cabinet that may impede the flow of air through the ventilation openings.
- 9. Heat** - The appliance should be situated away from heat sources, such as radiators, heat registers, stoves, or other appliances (including amplifiers) that produce heat.
- 10. Power Sources** - The appliance should only be connected to a power supply of the type described in the operating instructions or as marked on the appliance.
- 11. Power Cord Protection** - Power supply cords should be routed so that they are not likely to be walked on or pinched by items placed upon or against them, paying particular attention to cords and plugs, convenience receptacles, and the point where they exit from the appliance.
- 12. Cleaning** - The appliance should be cleaned only as recommended by the manufacturer.
- 13. Power Lines** - An outdoor antenna should be located away from power lines.
- 14. Non-use Periods** - The power cord of the appliance should be unplugged from the outlet when the appliance is unused for a long period of time.
- 15. Object and Liquid Entry** - Care should be taken so that objects do not fall and liquids are not spilled through openings into the enclosure.
- 16. Damage Requiring Service** - The appliance should be serviced by qualified service personnel when:
  - A.** The power supply cord or the plug has been damaged; or
  - B.** Objects have fallen or liquid has spilled into the appliance; or
  - C.** The appliance has been exposed to rain; or
  - D.** The appliance does not appear to operate normally or exhibits a marked change in performance; or
  - E.** The appliance has been dropped or the enclosure damaged.
- 17. Servicing** - The user should not attempt to service the appliance beyond as described in the operating instructions. All other servicing should be referred to qualified service personnel.

# CONTROLS

TOP VIEW

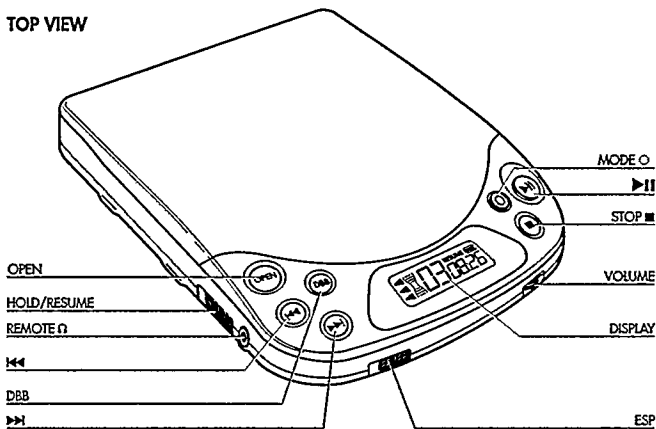

BOTTOM VIEW

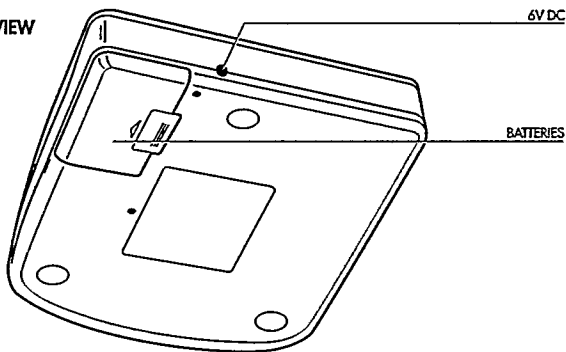

# CONTROLS

- DISPLAY** ..... Window for showing the different playing modes, tracks and times
- OPEN** ..... Button for opening the lid of the CD player
- VOLUME** ..... Control for adjusting the volume at the headphone output
- ▶||** ..... Button for starting and pausing CD play
- STOP ■** ..... Button for stopping CD play, deleting various settings, and switching off the CD player
- DBB** ..... **Dynamic Bass Boost:** Button for boosting the bass response
- ◀◀** ..... Button for selecting the previous music track or, if held down, for searching backward for a particular passage on the CD
- ▶▶** ..... Button for selecting the next music track or, if held down, for searching forward for a particular passage on the CD
- MODE ○** ..... Button for selecting the different playing modes:  
SHUFFLE--REPEAT/SHUFFLE--REPEAT--off
- ESP** ..... **Electronic Skip Protection:** Switch for activating the electronic buffer memory for an undisturbed sound
- RESUME/HOLD** ..... Switch for activating the RESUME feature (resuming CD play) and/or HOLD feature (blocking all buttons)
- REMOTE**  ..... Headphone control jack (3.5mm)
- 6 V DC** ..... Jack for external power supply
- Battery compartment** ..which holds four batteries

**WARNING:** To reduce the risk of fire or electric shock, do not expose this appliance to rain or moisture.

**CAUTION:** Use of controls or adjustments or performance of procedures other than those herein may result in hazardous radiation exposure.

*The set complies with the FCC-Rules, Part 15 and with 21 CFR 1040.10.*

**REMOTE  – headphone control jack**

- Connect the supplied headphones (16-32 ohms /3.5mm jack plug) with the REMOTE  jack.

*Note : Use this jack also for connecting your HiFi system or your car radio (the cassette adapter from the car accessory kit or a signal lead): in both cases the volume of the CD player has to be set to midposition (aprox. 6-8).*

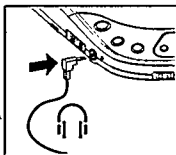
**Accessories**

- Headphones 3.5 mm.
- SBC 6622 - AC power adapter.

**Use your head when using headphones**

- **Hearing safety:** Do not play your headset at a high volume. Hearing experts advise against continual extended play.
- If you experience a ringing in your ears, reduce the volume or discontinue use.
- **Traffic safety:** Do not use while driving a motorized vehicle. Using while driving may create a traffic hazard and is illegal in many areas.
- You should use extreme caution or temporarily discontinue use in potentially hazardous situations.
- Even if your headset is an open-air type designed to let you hear outside sounds, don't turn up the volume so high that you can't hear the sounds around you.

EL 3498-2



# POWER SUPPLY

## AC power adapter SBC6622 (supplied)

- 1 Make sure that the local voltage corresponds to the voltage of the adapter (see accessories).
  - 2 Connect the supplied AC power adapter (6 V/400 mA Direct Current plus-pole to the center pin) to the player's 6 V DC jack and to the wall outlet.
- Always disconnect the adapter if you are not using it.

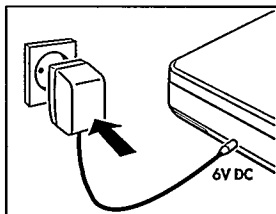

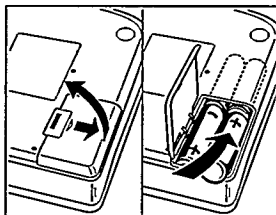

## Batteries, type R6, UM3 or AA (optional)

- Open the battery compartment and insert four alkaline batteries.
- Approx. playing times under normal conditions:  
Alkaline batteries: 10 hours
- Remove the batteries if they are empty or the CD player is not to be used for a long time.



*Note: In the top right corner of the display the battery condition will be indicated:*

- **Full** batteries: no indication.
- **Weak** batteries:  ("full" symbol) flashes. (This symbol is not available when nickel-cadmium batteries are used.)
- **Empty** batteries:  ("empty" symbol) flashes and the message BATT appears. Replace the batteries or connect the AC power adapter.

# OPERATION

## Inserting the CD

- Push gently on the CD center so that it fits onto the hub.

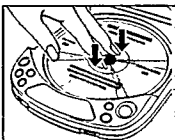

## Removing the CD

- Hold the CD by its edge and press the hub gently.



## Playing a CD

- 1 Open the lid by pressing the OPEN button.
  - 2 Insert an audio CD, printed side up.
  - 3 Close the lid by pushing it on its left side.
    - Display indication of: (example)  
 $23 = \text{total number of tracks} / 69:33 = \text{total playing time}$
  - 4 Press the ►|| button to start CD play.
    - Display indication of: (example)  
 $2 = \text{current track} / 1:08 = \text{elapsed time of current track}$
  - 5 Adjust the sound using the controls VOLUME and DBB.
  - 6 You can interrupt CD play by pressing the ►|| button. Continue CD play by pressing the ►|| button again.
    - Display indication of: time of the current position (flashing).
  - 7 Press the STOP ■ button to stop CD play.
    - Display indication of: total number of tracks / the total playing time.
- If you press the STOP ■ button again, you will switch off the set.

*Note: If no button is pressed for 10 seconds, the set will switch off automatically.*



## Selecting another track

- Briefly press the ◀◀ or ▶▶ button once/several times to skip to the beginning of the current/previous or next track(s).
  - Display indication of: selected track number.
  - During play: CD play continues automatically with the selected track.
  - In stop position: press the ▶|| button to start CD play.

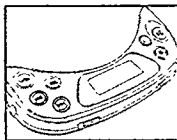

## Searching for a passage during CD play

- 1 Hold down the ◀◀ or ▶▶ button to find a particular passage in forward or backward direction.
  - After two seconds, searching will start at high speed.
- 2 Release the button when you have reached the desired passage.

*Note: In the shuffle mode, searching is only possible within the particular track.*

## MODE ○ – different playing modes

- By pressing the MODE ○ button, you can successively activate the playing modes:

**SHUFFLE:** The tracks are played *in random order* until all of them have been played once.

**SHUFFLE REPEAT:** All tracks are played *repeatedly in random order* until you leave this mode.

**REPEAT:** The CD is played *repeatedly* until you leave this mode.

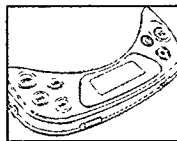

- Display indication of: an arrow pointing towards the selected playing mode.
  - During play: CD play continues automatically with the selected playing mode.
  - In stop position: press the ▶|| button to start CD play.
- Deactivate all modes with the MODE ○ button.

# OPERATION

## ESP – Electronic Skip Protection system

- Activate the ESP system by sliding the ESP switch to the right.
  - The ESP system constantly stores the CD data to be played in advance in order to prevent sound skipping during play caused by shock and vibration.
  - The ESP symbol in the display starts filling, as the example at the right illustrates:
  - The state of the ESP symbol in the display changes according to the state of the ESP memory.

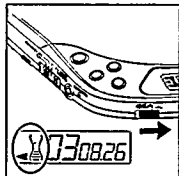

*Note: When switching the ESP system on and off, CD play will be delayed or interrupted for a short time.*

## RESUME / HOLD

### RESUME – playing from where you have stopped

- Activate the RESUME feature by sliding the RESUME/HOLD switch to the middle.
  - The display indicates: RESUME.
- If you stop CD play by pressing the STOP ■ button, the last played position will be stored.
- Press ►|| to resume CD play from the position where it was stopped.

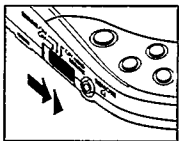

*Note: Do not open the lid. Otherwise, the information about the position last played gets lost.*

### HOLD – Deactivating all buttons

- Activate the HOLD feature by sliding the RESUME/HOLD switch to the very right.
  - Now, all buttons are deactivated and will not function until you switch the feature off again. The lid cannot be opened.
  - If you press a button (except OPEN), the display will indicate HOLD.

*Note: In the hold position, the resume function is automatically activated.*

# GENERAL INFORMATION

## Maintenance and CD handling

- The lens (⊗) of the CD player should never be touched!
- Do not expose the CD player, batteries or CDs to rain, dampness, sand, dust or excessive heat caused by heating equipment, or to direct sunlight (for example inside a car parked in the sun).
- The lens may cloud over when the set is suddenly moved from cold to warm surroundings. Playing a CD is then not possible. Leave the CD player in a warm environment until the moisture evaporates.
- You can clean the CD player with a soft and slightly dampened chamois leather. Do not use any cleaning agents as they may have a corrosive effect.
- Always pick up the CD by the edge and put it back in its box after use.
- To clean the CD, wipe it off in a straight line from the center towards the edge using a soft, lint-free cloth. A cleaning agent may damage the disc!
- When a newly purchased CD does not stay on the hub, this is caused by small burrs around the center hole of the CD. Remove the burrs by rubbing the edge of the center hole with a pen or other such instrument.





## Environmental information

Please observe the local regulations regarding the disposal of packing materials, exhausted batteries, and old equipment.

- All redundant packaging material has been omitted. We have done our utmost to make the packaging easy separable into three mono-materials: cardboard (box), expandable polystyrene (buffer), polyethylene (bags, protective foam sheet)
- Your set consists of materials which can be recycled if disassembled by a specialized company.
- Do not dispose of exhausted batteries with your household waste.

# TROUBLESHOOTING

- If a problem occurs, please check the points listed below before taking your set for repair.
- If you are not able to remedy a problem by following these hints, consult your dealer or service facility.

Problem	Possible cause	Remedy
<b>No power or CD play does not start</b> Display: no indication	<b>Batteries</b> Batteries incorrectly inserted	Insert the batteries correctly
	Use of new batteries	Press ►
	Batteries are empty	Change/recharge the batteries
	Contact pins are dirty	Clean them with a cloth
	<b>AC power adapter</b> Loose connection	Connect the adapter securely
 <b>CD play does not start or interrupts</b> Display: -no indication or -ERROR or -NO DISC	<b>HOLD feature is activated</b>	<b>Switch off the HOLD feature</b>
	Moisture condensation	Leave the player in a warm place until the moisture evaporates
	CD lid is not securely closed	Close the lid securely
	CD is not or incorrectly inserted	Insert a CD, label facing up
	CD is badly scratched	Use another CD
CD is dirty	Clean the CD	
 <b>Lid of CD player does not open</b>	<b>HOLD feature is activated</b>	<b>Switch off the HOLD feature</b>
<b>Play does not start from the first track</b>	RESUME or SHUFFLE is activated	Switch off RESUME or SHUFFLE

# TROUBLESHOOTING

Under no circumstances should you try to repair the unit yourself, as this will invalidate the warranty.

<b>Problem</b>	<b>Possible cause</b>	<b>Remedy</b>
<b>No sound or bad sound quality</b>	PAUSE is activated	Press ►
	Loose or wrong connections	Check connections
	Volume is not turned up	Adjust the volume
	Headphones worn the wrong way	Pay attention to the <b>L</b> (left) and <b>R</b> (right) indications
	Headphone plug is dirty	Clean the headphone plug
	Strong magnetic fields near the CD player	Change the player's position or connections
	Electrostatic discharge of the user through the CD player	Press ◀◀ or ▶▶ once or press ►   twice
	<b>In-car use</b>	
	Strong vibrations	Find another place for the set
	Adapter cassette is incorrectly inserted	Insert the adapter cassette correctly
Temperature inside car is too high/low	Let the CD player acclimatize	
Cigarette lighter/jack is too dirty	Clean the cigarette lighter/jack	
Wrong playback direction of the auto reverse feature of the car cassette player	Change the auto reverse direction	

## LIMITED WARRANTY

### MAGNAVOX PORTABLE COMPACT DISC

One Year Free Exchange

This product must be carried in for an exchange.

#### **WHO IS COVERED?**

You must have proof of purchase to exchange the product. A sales receipt or other document showing that you purchased the product is considered proof of purchase. Attach it to this owner's manual and keep both nearby.

#### **WHAT IS COVERED?**

Warranty coverage begins the day you buy your product. For one year thereafter, a defective or inoperative product will be replaced with a new, renewed or comparable product at no charge to you. A replacement product is covered only for the original warranty period. When the warranty on the original product expires, the warranty on the replacement product also expires.

#### **WHAT IS EXCLUDED?**

Your warranty does not cover:

- labor charges for installation or setup of the product, adjustment of customer controls on the product, and installation or repair of antenna systems outside of the product.
- product repair and/or part replacement because of misuse, accident, unauthorized repair or other cause not within the control of Philips Consumer Electronics Company.
- reception problems caused by signal conditions or cable or antenna systems outside the unit.
- a product that requires modification or adaptation to enable it to operate in any country other than the country for which it was designed, manufactured, approved and/or authorized, or repair of products damaged by these modifications.
- incidental or consequential damages resulting from the product. (Some states do not allow the exclusion of incidental or consequential damages, so the above exclusion may not apply to you. This includes, but is not limited to, prerecorded material, whether copyrighted or not copyrighted.)
- a product that is used for commercial or institutional purposes.

#### **WHERE IS EXCHANGE AVAILABLE?**

You may exchange the product in all countries where the product is officially distributed by Philips Consumer Electronics Company. In countries where Philips Consumer Electronics Company does not distribute the product, the local Philips service organization will attempt to provide a replacement product (although there may be a delay if the appropriate product is not readily available).

#### **BEFORE REQUESTING EXCHANGE...**

Please check your owner's manual before requesting an exchange. Adjustments of the controls discussed there may save you a trip.

---

Philips Service Company, P.O. Box 555,  
Jefferson City, Tennessee 37760, (423) 475-8869



### **EXCHANGING A PRODUCT IN U.S.A., PUERTO RICO OR U.S.VIRGIN ISLANDS...**

Contact your dealer to arrange an exchange. Or, ship the product, insured and freight prepaid, and with proof of purchase enclosed, to the address listed below.

Small Product Service Center  
Philips Service Company  
907 Snapps Ferry Road, Plant 2, Building 6  
Greeneville, TN 37743

(In U.S.A., Puerto Rico and U.S.Virgin Islands, all implied warranties, including implied warranties of merchantability and fitness for a particular purpose, are limited in duration to the duration of this express warranty. But, because some states do not allow limitations on how long an implied warranty may last, this limitation may not apply to you.)

### **EXCHANGING A PRODUCT IN CANADA...**

Contact your dealer to arrange an exchange. Or, ship the product, insured and freight prepaid, and with proof of purchase enclosed, to one of the Philips consumer service centers listed below.

Philips Electronics Ltd.  
601 Milner Avenue, Scarborough, Ontario, M1B 1M8  
(416) 292-5161  
4977 Levy Street, St. Laurent, Québec, H4R 2N9  
(514) 956-0120  
1741 Boundary Road, Vancouver, B.C., V5M 3Y7  
(604) 294-3441

(In Canada, this warranty is given in lieu of all other warranties. No other warranties are expressed or implied, including any implied warranties of merchantability or fitness for a particular purpose. Philips is not liable under any circumstances for any direct, indirect, special, incidental or consequential damages, howsoever incurred, even if notified of the possibility of such damages.)

### **TO GET OUT-OF-WARRANTY EXCHANGE...**

In U.S.A., Puerto Rico or U.S.Virgin Islands, contact Philips Service Company at (800) 851-8885 to obtain the cost of out-of-warranty exchange. Then carefully pack the product and ship it to the Small Product Service Center (address listed above). In Canada, contact the nearest Philips consumer service center (phone number and address listed above) to obtain the cost of out-of-warranty exchange. Then carefully pack the product and ship it to that service center.

### **REMEMBER...**

Please record the model and serial numbers found on the product below. Also, please fill out and mail your warranty registration card promptly. It will be easier for us to notify you if necessary.

MODEL # \_\_\_\_\_

SERIAL # \_\_\_\_\_

*This warranty gives you specific legal rights. You may have other rights  
which vary from state/province to state/province.*

EL4967E004 / MAC 4110 / 12-95





# PHILIPS CONSUMER ELECTRONICS COMPANY

A Division of Philips Electronics North America Corporation  
Knoxville, Tennessee 37914-1810, U.S.A.



3140 115 2362.1

PRINTED IN HONG KONG

IB7748T001/VieSRP9643

## Free Manuals Download Website

<http://myh66.com>

<http://usermanuals.us>

<http://www.somanuals.com>

<http://www.4manuals.cc>

<http://www.manual-lib.com>

<http://www.404manual.com>

<http://www.luxmanual.com>

<http://aubethermostatmanual.com>

Golf course search by state

<http://golfingnear.com>

Email search by domain

<http://emailbydomain.com>

Auto manuals search

<http://auto.somanuals.com>

TV manuals search

<http://tv.somanuals.com>