

User guide

MAGNAVOX
SMART. VERY SMART.

MAS-100 MINI HI-FI STEREO SYSTEM



Read this manual first!

Congratulations on purchasing this Magnavox product. We've included everything you need to get started.

If you have any problems, Magnavox Representatives can help you get the most from your new product by explaining:

- Hookups,
- First Time Setup, and
- Feature Operation.

Do not attempt to return this product to the store.

For fast help, call us first!

1-800-705-2000

Thank you for making Magnavox a part of your home!



824000934231

Canada

English:

This digital apparatus does not exceed the Class B limits for radio noise emissions from digital apparatus as set out in the Radio Interference Regulations of the Canadian Department of Communications.

Français:

Cet appareil numérique n'émet pas de bruits radioélectriques dépassant les limites applicables aux appareils numériques de Class B prescrites dans le Règlement sur le Brouillage Radioélectrique édicté par le Ministère des Communications du Canada.

This warning label is located on the rear side and inside this laser product.

CAUTION: INVISIBLE LASER RADIATION WHEN OPEN. DO NOT STARE INTO BEAM.

DANGER: INVISIBLE LASER RADIATION WHEN OPEN. AVOID DIRECT EXPOSURE TO BEAM.

VARO! AVATTAESSA JA SUOJALUKITUS OHITETTAESSA OLET ALTTIINANAKYMATTOMAALE LASERSATEILYLLE. ALA KATSO SATEESEEN.

WARNING! OSYNLIG LASERSTRÅLNING NÄR DENNA DEL ÄR ÖPPNAD. OCH SPARREN ÄR URKOPPLAD BETRAKTA EJ STRÅLEN.

or

DANGER - Invisible laser radiation when open. AVOID DIRECT EXPOSURE TO BEAM.

CAUTION

Use of controls or adjustments or performance of procedures other than herein may result in hazardous radiation exposure or other unsafe operation.

ATTENTION

L'utilisation des commandes ou réglages ou le non-respect des procédures ci-incluses peuvent se traduire par une exposition dangereuse à l'irradiation.

ATENCIÓN

El uso de mando o ajustes o la ejecución de métodos que no sean los aquí descritos puede ocasionar peligro de exposición a radiación.

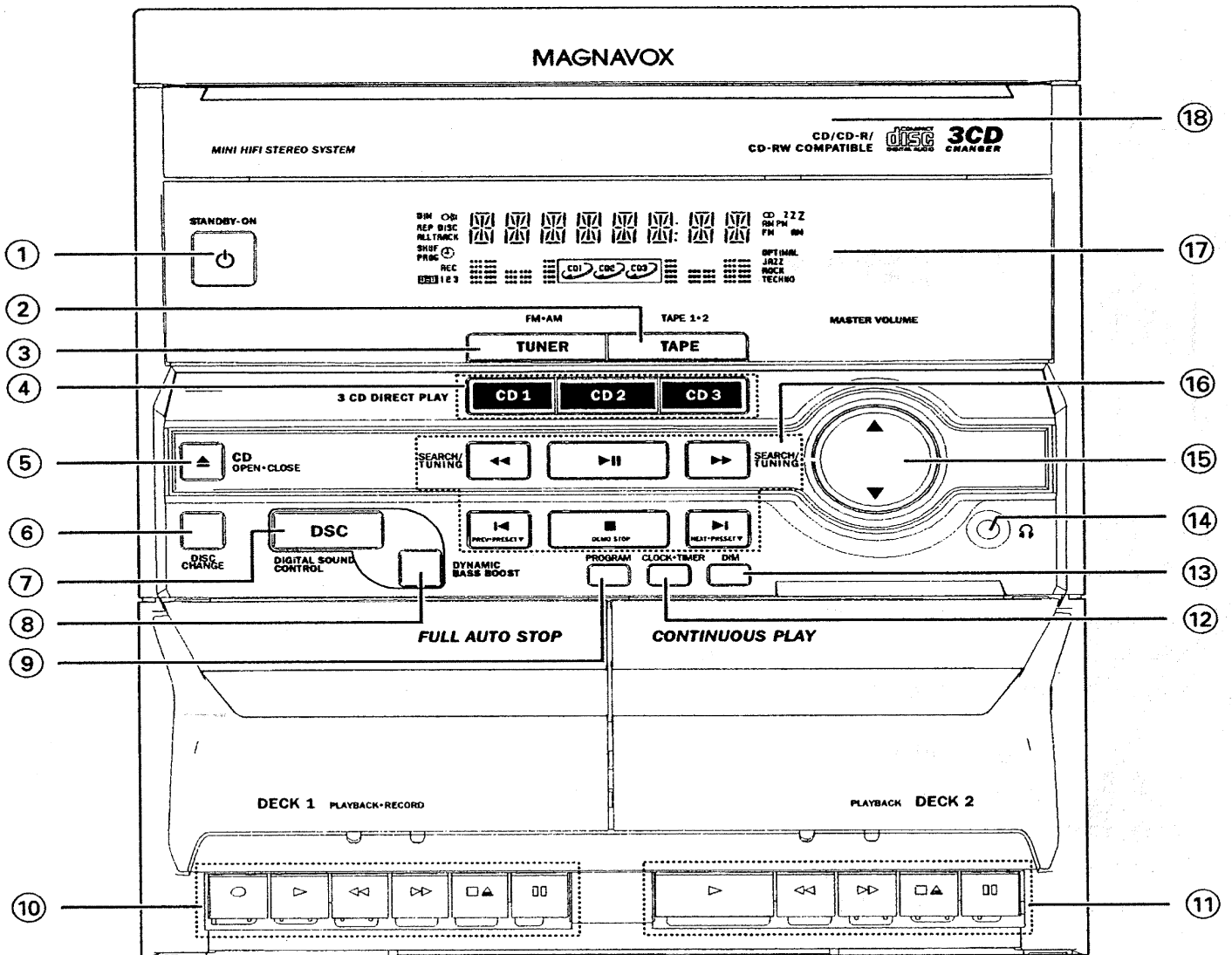
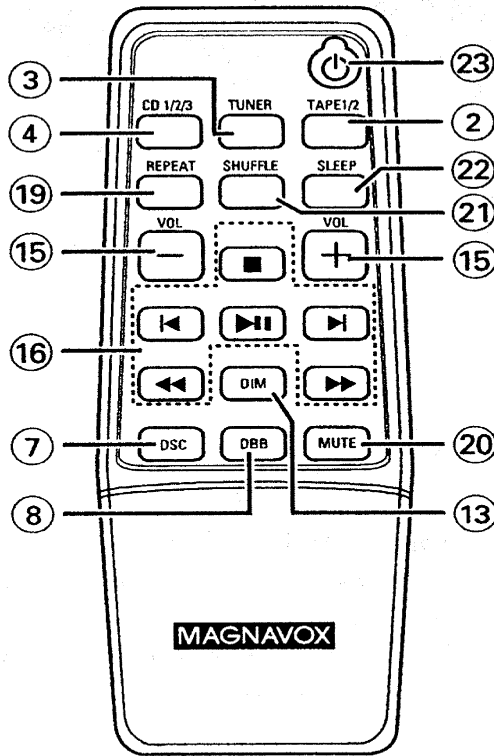

Return your Warranty Registration card today to ensure you receive all the benefits you're entitled to.

- Once your Magnavox purchase is registered, you're eligible to receive all the privileges of owning a Magnavox product.
- So complete and return the Warranty Registration Card enclosed with your purchase at once, and take advantage of these important benefits.

Warranty Verification

Registering your product within 10 days confirms your right to maximum protection under the terms and conditions of your Magnavox warranty.

Owner Confirmation

Your completed Warranty Registration Card serves as verification of ownership in the event of product theft or loss.

Model Registration

Returning your Warranty Registration Card right away guarantees you'll receive all the information and special offers which you qualify for as the owner of your model.

Know these
safety symbols

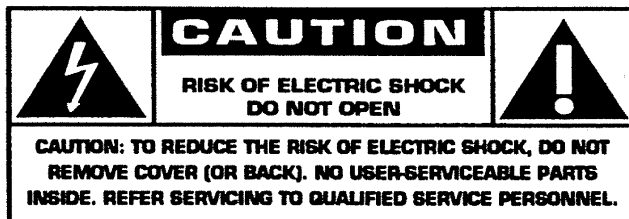

 This "bolt of lightning" indicates uninsulated material within your unit may cause an electrical shock. For the safety of everyone in your household, please do not remove product covering.

 The "exclamation point" calls attention to features for which you should read the enclosed literature closely to prevent operating and maintenance problems.

For Customer Use

Enter below the Serial No. which is located on the rear of the cabinet. Retain this information for future reference.

Model No. _____

Serial No. _____

WARNING: TO PREVENT FIRE OR SHOCK HAZARD, DO NOT EXPOSE THIS EQUIPMENT TO RAIN OR MOISTURE.

CAUTION: To prevent electric shock, match wide blade of plug to wide slot, and fully insert.

MAGNAVOX



***Congratulations on your purchase,
and welcome to the "family!"***

Dear Magnavox product owner:

Thank you for your confidence in Magnavox. You've selected one of the best-built, best-backed products available today. And we'll do everything in our power to keep you happy with your purchase for many years to come.

As a member of the Magnavox "family," you're entitled to protection by one of the most comprehensive warranties and outstanding service networks in the industry.

What's more, your purchase guarantees you'll receive all the information and special offers for which you qualify, plus easy access to accessories from our convenient home shopping network.

And most importantly you can count on our uncompromising commitment to your total satisfaction.

All of this is our way of saying welcome – and thanks for investing in a Magnavox product.

Sincerely,

Lawrence J. Blanford
President and Chief Executive Officer

**P.S. Remember, to get the most from your Magnavox product,
you must return your Warranty Registration Card within
10 days. So please mail it to us right now!**

IMPORTANT SAFETY INSTRUCTIONS

1. Read these instructions.
2. Keep these instructions.
3. Heed all warnings.
4. Follow all instructions.
5. Do not use this apparatus near water.
6. Clean only with a dry cloth.
7. Do not block any ventilation openings. Install in accordance with the manufacturer's instructions.
8. Do not install near any heat sources such as radiators, heat registers, stoves, or other apparatus (including amplifiers) that produce heat.
9. Do not defeat the safety purpose of the polarized or grounding-type plug. A polarized plug has two blades with one wider than the other. A grounding type plug has two blades and a third grounding prong. The wide blade or the third prong are provided for your safety. If the provided plug does not fit into your outlet, consult an electrician for replacement of the obsolete outlet.
10. Protect the power cord from being walked on or pinched, particularly at plugs, convenience receptacles, and the point where they exit from the apparatus.
11. Only use attachments/accessories specified by the manufacturer.

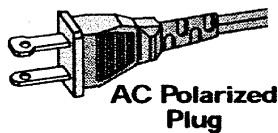

12.  Use only with the cart, stand, tripod, bracket, or table specified by the manufacturer or sold with the apparatus. When a cart is used, use caution when moving the cart/apparatus combination to avoid injury from tip-over.

13. Unplug this apparatus during lightning storms or when unused for long periods of time.

14. Refer all servicing to qualified service personnel. Servicing is required when the apparatus has been damaged in any way, such as power-supply cord or plug is damaged, liquid has been spilled or objects have fallen into the apparatus, the apparatus has been exposed to rain or moisture, does not operate normally, or has been dropped.

15. **Battery usage CAUTION** – To prevent battery leakage which may result in bodily injury or damage to the unit:

- Install **all** batteries correctly, + and - as marked on the unit.
- Do not mix batteries (**old** and **new** or **carbon** and **alkaline**, etc.).
- Remove batteries when the unit will not be used for a long time.

EL 6475-E003: 01/6

Class II equipment symbol



This symbol indicates that the unit has a double insulation system

English ----- 8

Français ----- 33

Español ----- 59

English

Français

Español

Contents

General Information

Supplied accessories	9
Environmental information	9
Safety information	9

Preparations

Rear connections	10–11
Power	
Antennas connection	
Speakers connection	
Inserting batteries into the remote control.	11

Controls

Controls on the system and remote control	12
---	----

Basic Functions

Plug and Play	13
Demonstration mode	14
Switching the system on	14
Switching the system to standby mode	14
Dim mode	14
Volume control	14
Sound control	15
DSC (Digital Sound Control)	
DBB (Dynamic Bass Boost)	

CD Operation

Discs for playback	16
Loading discs	16
Playing discs	17
Selecting a desired track/passage	17
Replacing discs during playback	17
Repeat and Shuffle	17–18
Repeat play	
Random play	
Programming the disc tracks	18
Erasing the program	18

Radio Reception

Tuning to radio stations	19
Storing preset radio stations	19–20
Automatic preset programming	
Manual preset programming	
Tuning to preset radio stations	20
Erasing a preset radio station	20

Tape Operation/Recording

Loading tape	21
Playing tapes	21
Rewinding/Fast forwarding	22
General information on recording	22
Preparation for recording	22
One touch recording	22
CD Synchronized start recording	22
Dubbing tapes	23

Maintenance

23

Clock/Timer

View clock	24
Clock setting	24
Timer setting	24–25
Deactivating the timer	
Activating the timer	
Sleep timer setting	25

Specifications

26

Troubleshooting

27–28

This system complies with the FCC rules, Part 15 and with 21 CFR 1040.10.

Operation is subject to the following two conditions:

- This device may not cause harmful interference, and***
- This device must accept any interference received, including interference that may cause undesired operation.***

Supplied accessories

- 2 speaker boxes
- remote control
- AM loop antenna
- FM wire antenna

Environmental information

All unnecessary packaging has been omitted. We have tried to make the packaging easy to separate into three materials: cardboard (box), polystyrene foam (buffer) and polyethylene (bags, protective foam sheet).

Your system consists of materials which can be recycled and reused if disassembled by a specialized company. Please observe the local regulations regarding the disposal of packaging materials, exhausted batteries and old equipment.

Safety information

- Before operating the system, check that the operating voltage indicated on the typeplate (or the voltage indication beside the voltage selector) of your system is identical with the voltage of your local power supply. If not, please consult your dealer.
- Place the system on a flat, hard and stable surface.
- Place the system in a location with adequate ventilation to prevent internal heat build-up in your system. Allow at least 10 cm (4 inches) clearance from the rear and the top of the unit and 5 cm (2 inches) from each side.
- Do not expose the system, batteries or discs to excessive moisture, rain, sand or heat sources caused by heating equipment or direct sunlight.
- The lens may cloud over when the system is suddenly moved from cold to warm surroundings, making it impossible to play a disc. Leave the system in the warm environment until the moisture evaporates.
- The mechanical parts of the set contain self-lubricating bearings and must not be oiled or lubricated.
- **When the system is switched to Standby mode, it is still consuming some power. To disconnect the system from the power supply completely, remove the AC power plug from the wall socket.**

Preparations

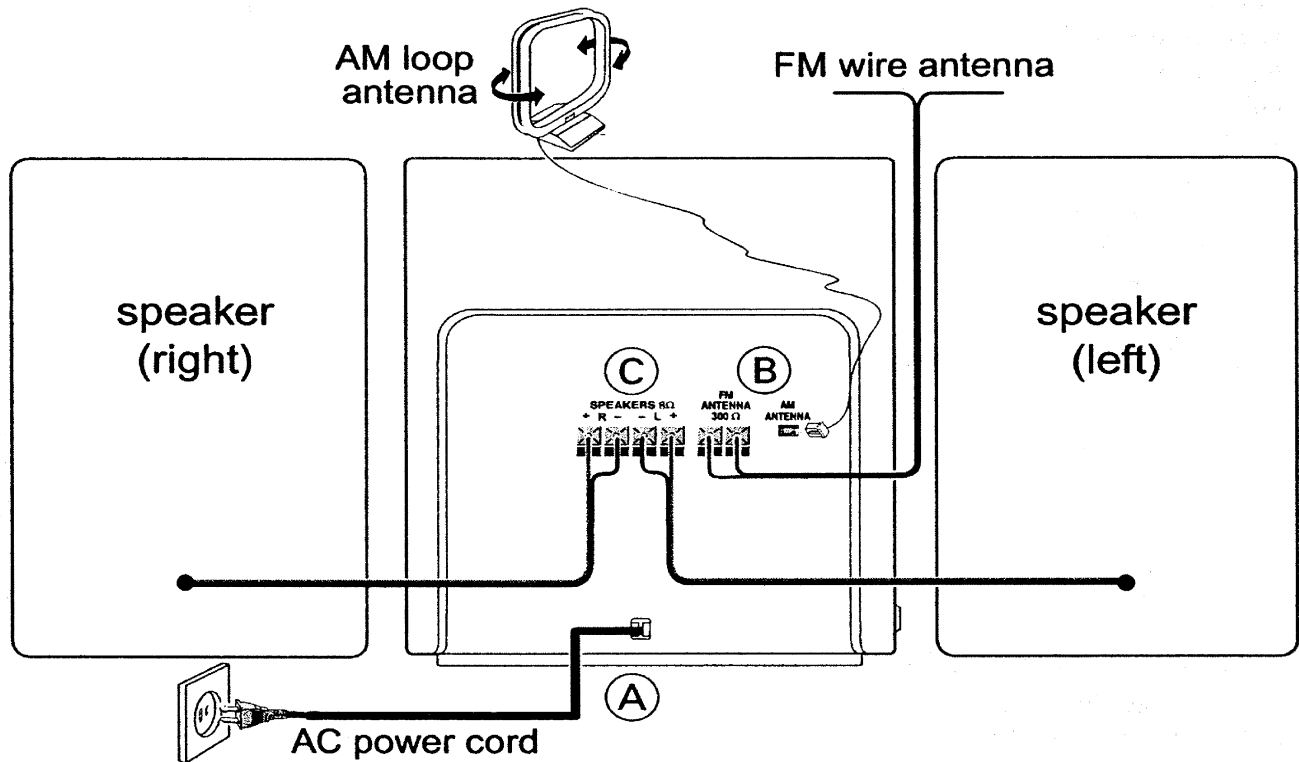

Rear connections

The type plate is located at the rear of the system.

A Power

Before connecting the AC power cord to the wall outlet, ensure that all other connections have been made.

WARNING!

- For optimal performance, use only the original power cable.
- Never make or change any connections with the power switched on.

B Antennas Connection

Connect the supplied AM loop antenna and FM antenna to the respective terminals. Adjust the position of the antenna for optimal reception.

AM Antenna

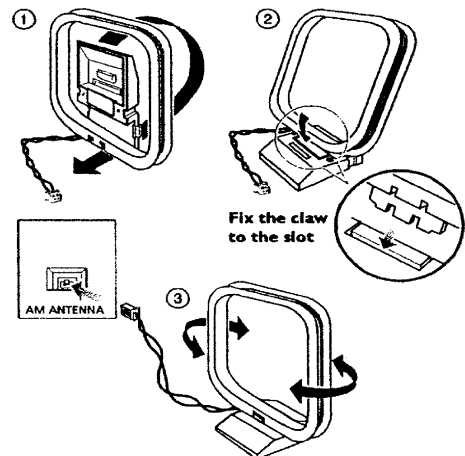

- Position the antenna as far as possible from a TV, VCR or other radiation source.

FM Antenna

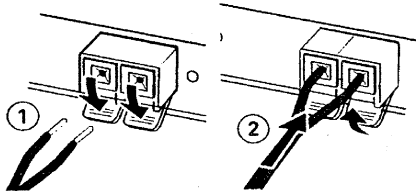

- For better FM stereo reception, connect an outdoor FM antenna to the FM AERIAL (FM ANTENNA) terminal.

Speakers Connection

Front Speakers

Connect the speaker wires to the SPEAKERS terminals, right speaker to "R" and left speaker to "L", colored (marked) wire to "+" and black (unmarked) wire to "-".

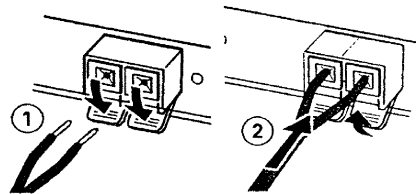



- Fully insert the stripped portion of the speaker wire into the terminal as shown.

Notes:

- For optimal sound performance, use the supplied speakers.

Controls (illustrations on page 3)

Controls on the system and remote control

- ① **STANDBY ON** 
- to switch the system on or to standby mode.
- ② **TAPE** (TAPE 1/2)
- to select tape mode.
- ③ **TUNER** (FM•AM)
- to select waveband : FM or AM.
- ④ **CD 1 / CD 2 / CD 3** (CD 1/2/3)
- to select disc tray 1, 2 or 3.
- ⑤ **CD OPEN/CLOSE**
- to open or close the disc tray.
- ⑥ **DISC CHANGE**
- to change disc(s).
- ⑦ **DIGITAL SOUND CONTROL (DSC)**
- to select the desired sound effect : JAZZ, ROCK, TECHNO or OPTIMAL.
- ⑧ **DYNAMIC BASS BOOST (DBB)**
- to select the desired bass boost level.
- ⑨ **PROGRAM**
- for CD to program disc tracks.
 - for Tuner to program preset radio stations.
 - for Clock to select 12- or 24-hour clock mode.
 - for Timer to select CD program mode as the wake up source.
- ⑩ **Tape deck 1 operation**
- to start recording.
 - ▶ to start playback.
 - ◀◀ / ▶▶ to rewind or fast forward.
 - ▲ to stop playback/recording or to open the tape door.
 - || to interrupt playback or recording.
- ⑪ **Tape deck 2 operation**
- ▶ to start playback.
 - ◀◀ / ▶▶ to rewind or fast forward.
 - ▲ to stop playback or to open the tape door.
 - || to interrupt playback.
- ⑫ **CLOCK•TIMER**
- to view the clock, set the clock or set the timer.
- ⑬ **DIM**
- to select different brightness for the display screen : DIM 1, DIM 2, DIM 3 or DIM OFF.
- ⑭ 
- to connect headphones.
- ⑮ **MASTER VOLUME ▲ ▼ (VOL +/-)**
- to increase or decrease the volume.
- ⑯ **Mode Selection**
- PLAY•PAUSE ▶ ||**
- for CD to start or interrupt playback.
 - for Plug & Play... (on the system only) to initiate and start plug & play mode.
- SEARCH/TUNING ◀◀ ▶▶**
- for CD to search backward/forward.
 - for Tuner to tune to a lower or higher radio frequency.
 - for Clock (on the system only) to set the hour.
- STOP•CLEAR / DEMO STOP ■**
- for CD to stop playback or to clear a program.
 - for Tuner (on the system only) to stop programming or to erase a selected preset.
 - for Demo (on the system only) to activate/deactivate the demonstration.
 - for Clock (on the system only) to exit clock setting or cancel timer.
 - for Plug & Play... (on the system only) to exit plug & play mode.
- PREV ◀ / NEXT ▶ (PRESET ▼ / ▲)**
- for CD to skip to the beginning of the current, previous, or next track.
 - for Tuner to select a preset radio station.
 - for Clock (on the system only) to set the minute.
- ⑰ **Display screen**
- to view the current status of the system.
- ⑱ **Disc tray**
- ⑲ **REPEAT**
- to playback track(s)/disc(s)/program repeatedly.
- ⑳ **MUTE**
- to interrupt or resume sound reproduction.
- ㉑ **SHUFFLE**
- to playback all available discs and their tracks/program in random order.
- ㉒ **SLEEP**
- to activate/deactivate or set the sleep timer.
- ㉓ 
- to switch the system to standby mode.

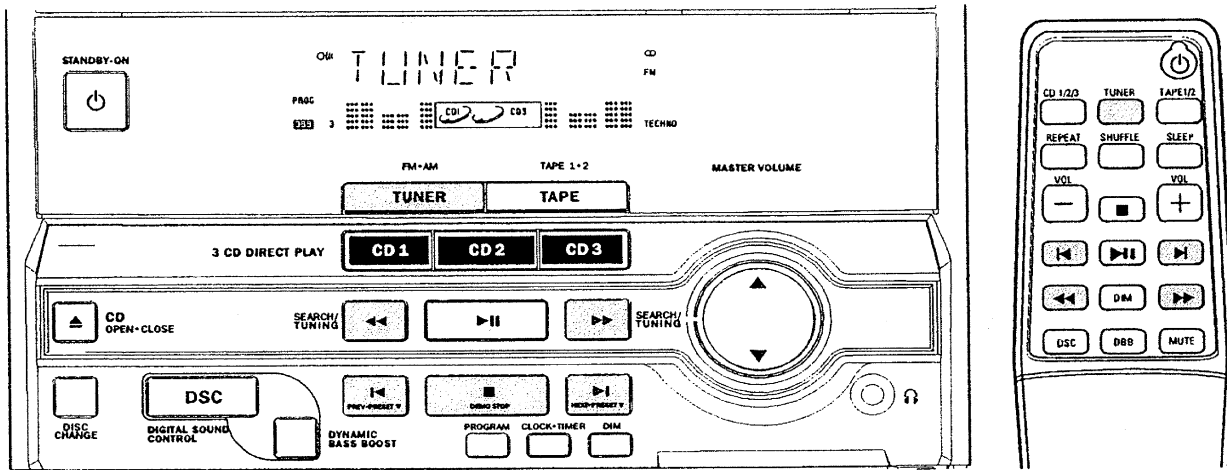

IMPORTANT!

Before you operate the system, complete the preparation procedures.

Plug and Play

Plug and Play allows you to store all available radio stations automatically.

First time setup/power up

- 1 When you turn on the main power, "AUTO INSTALL - PRESS PLAY" is displayed.
- 2 Press ►|| on the system to start installation.
 - "INSTALL" is displayed, followed by "TUNER" and "AUTO".
 - **PROG** starts flashing.
 - All available radio stations with sufficient signal strength will be stored automatically, starting from FM and followed by AM band.
 - When all the available radio stations are stored or the memory for 40 presets are used, the last preset radio station will be played.

To reinstall Plug and Play

- 1 In Standby or Demonstration mode, press and hold ►|| on the system until "AUTO INSTALL - PRESS PLAY" is displayed.
- 2 Press ►|| again to start installation.
 - All previously stored radio stations will be replaced.

To exit without storing the Plug and Play

- Press ■ on the system.
 - If you do not complete the Plug and Play installation, the function will be restarted when you next turn on the main power again.

Notes:

- When the power is turned on, the disc tray may open and close to initialize the system.
- If no stereo frequency is detected during Plug and Play, "CHECK ANTENNA" will be displayed.
- During Plug and Play, if no button is pressed within 15 seconds, the system will exit Plug and Play mode.

Basic Functions

Demonstration mode

The system has a demonstration mode that shows the various available features.

To activate the demonstration

- In standby mode, press and hold **■** on the system until "WELCOME" is displayed.
→ The demonstration will begin.

To deactivate the demonstration

- Press and hold **■** on the system until "DEMO OFF" is displayed.
→ The system will switch to standby mode.

Note:

– If you have not deactivated the demonstration, it will resume five seconds after the system switches to standby mode.

Switching the system on

In standby/demonstration mode

- Press **STANDBY ON** to switch on the last selected source.
- Press **CD 1/2/3**, **TUNER** or **TAPE (TAPE 1/2)**.
- Press **CD OPEN/CLOSE**.
→ The system will switch to CD mode.

Switching the system to standby mode

In demonstration mode

- Press and hold **■** on the system.

In any other source mode

- Press **STANDBY ON** (or **⏻** on the remote control).
→ The clock will appear on the display when the system is in standby mode.

Dim mode

You can select the desired brightness for the display.

- In any source mode (except standby mode), press **DIM** repeatedly to select : DIM 1, DIM 2, DIM 3 or DIM OFF.
→ **DIM** is shown, except for DIM OFF mode.

DIM mode	Brightness	Spectrum Analyzer
1	normal	off
2	half	on
3	half	off
OFF	normal	on

Note:

– In standby mode, pressing DIM to select half or full brightness for clock display.

Volume control

Press **MASTER VOLUME ▲** or **▼ (VOL +** or **–** on the remote control) to increase or decrease the volume level.

To listen through the headphones

- Connect the headphones plug to the  socket at the front of the system.
→ The speakers will be muted.

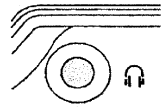

To switch off the volume temporarily

- Press **MUTE** on the remote control.
→ Playback will continue without sound and "MUTE" is displayed.
- To restore the volume, press **MUTE** again or increase the volume level.

Sound control

DSC (Digital Sound Control)

The DSC feature enables you to enjoy special sound effects that have preset equalizer settings, which provide improved music reproduction.

- Press **DSC** to select : JAZZ, ROCK, TECHNO or OPTIMAL.
→ The selected DSC is shown.

DBB (Dynamic Bass Boost)

There are three DBB settings to enhance the bass response.

- Press **DBB** repeatedly to select a bass boost level.
→ "DBB 1 (or 2/3)" and the respective bass boost level are shown.

To deactivate DBB

- Press **DBB** repeatedly until "DBB OFF" is displayed.

Note:

– Some discs or tapes might be recorded in high modulation, which causes a distortion at high volume. If this occurs, switch off DBB or reduce the volume.

Automatic DSC-DBB selection

The best DBB setting is generated automatically for each DSC selection. You can manually select the DBB setting that best suits your listening environment.

DSC	DBB
JAZZ	off
ROCK	on (3)
TECHNO	on (3)
OPTIMAL	on (2)

CD Operation

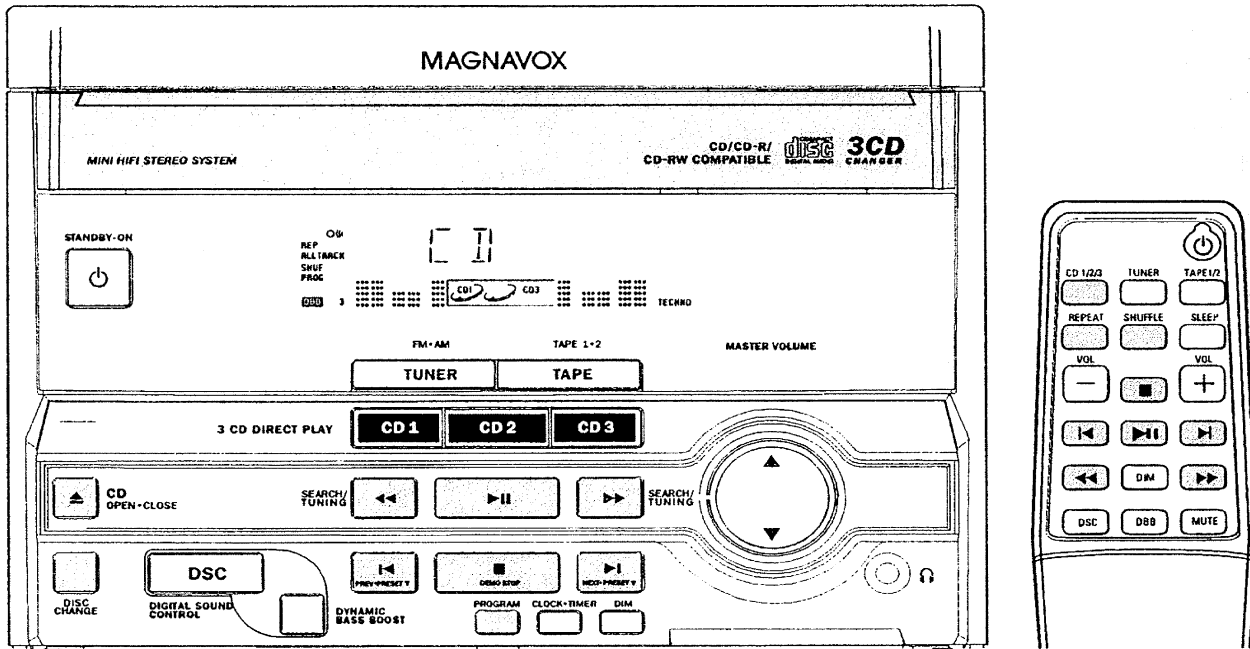

IMPORTANT!

- This system is designed for regular discs. Therefore, do not use any accessories such as disc stabilizer rings or disc treatment sheets, etc., which may jam the changer mechanism.
- Do not load more than one disc into each tray.

Discs for playback

This system can playback all digital audio CD, finalized digital audio CD-Recordable (CDR) discs and finalized digital audio CD-Rewritable (CDRW) discs.



Loading discs

- 1 Press **CD OPEN/CLOSE** to open the disc tray.
- 2 Load up to two discs on the individual disc trays. To load the third disc, press **DISC CHANGE**.
→ The disc tray will rotate until the empty tray is ready for loading.

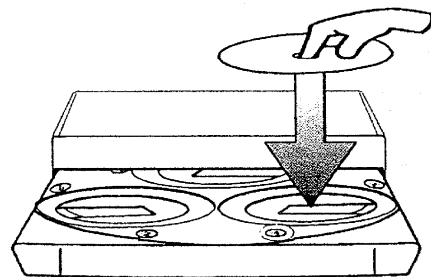

- 3 Press **CD OPEN/CLOSE** to close the disc tray.
→ "READING" is displayed. The selected disc tray, total number of tracks and the playing time will appear on the display.

Notes:

- Load the discs with the label side facing up.
- To ensure good system performance, wait until the disc tray completely reads the disc(s) before proceeding.

Playing discs



a disc is loaded in the disc tray



the current selected disc tray is empty



the current selected disc tray is loaded or playing

To play all discs on the disc tray

- Press **▶||**.
 - All the available discs will play once, then stop.
 - During playback, the selected disc tray, track number and elapsed playing time of the current track are displayed.

To play the selected disc only

- In CD mode, press **CD 1**, **CD 2** or **CD 3** on the system.
 - The selected disc will play once, then stop.

To interrupt playback

- Press **▶||**.
 - The current track time flashes.
- To resume playback, press **▶||** again.

To stop playback

- Press **■**.

Selecting a desired track/passage

To search for a particular passage during playback

- Press and hold **◀◀** or **▶▶** and release it when the desired passage is located.
 - During searching, the volume will be reduced.

To select a desired track

- Press **◀** or **▶** repeatedly until the desired track is displayed.
- If playback is stopped, press **▶||** to start playback.

Note:

– In Shuffle mode, pressing **◀** will cause the player to skip only to the beginning of the current track.

To skip to the beginning of the current track during playback

- Press **◀** once.

Replacing discs during playback

- 1 Press **DISC CHANGE**.
 - The disc tray will open without interrupting current playback.
- 2 To change the inner disc, press **DISC CHANGE** again.
 - "DISC CHANGE" is displayed and the disc will stop playing.
 - The disc tray will close to retrieve the inner disc, then reopen with the inner disc accessible.

Repeat and Shuffle

You can select and change the various play modes before or during playback.

Repeat play

- 1 Press **REPEAT** on the remote control repeatedly to select :
 - "TRACK" – to repeat playback of the current track.
 - "DISC" – to repeat playback of the current disc.
 - "ALL" or "PROGRAM" – to repeat playback of all available discs or programmed tracks.
- 2 To resume normal playback, press **REPEAT** until "REPEAT OFF" is displayed.
 - **REP** is shown, except for REPEAT OFF mode.

Random play

- 1 Press **SHUFFLE** on the remote control.
 - **SHUF** is shown and "SHUFFLE" is displayed.
 - All the available discs or programmed tracks (if program is active) will be played in random order.
- 2 To resume normal playback, press **SHUFFLE** again.
 - **SHUF** disappears.

CD Operation

Notes:

- During program play or shuffling mode, it is not possible to repeat playback for the current disc (Repeat Disc mode).
- Pressing the CD OPEN/CLOSE button will cancel all repeat and shuffling modes.

Programming the disc tracks

Programming tracks is possible when playback is stopped. Up to 40 tracks can be stored in the memory in any order.

- 1 Load the desired discs on the disc tray (refer to "Loading discs").
- 2 Press **PROGRAM** to start programming.
→ **PROG** starts flashing.
- 3 Press **CD 1/2/3** to select a disc.
- 4 Press **◀** or **▶** repeatedly to select the desired track.
- 5 Press **PROGRAM** to store the track.
- Repeat **steps 3–5** to store other discs and tracks.
- 6 To end programming, press **■ once**.
→ **PROG** stays and the program mode remains active.
→ The total number of tracks programmed and the total playing time are displayed.
- 7 To start program play, press **▶II**.
→ "PLAY PROGRAM" is displayed.

Notes:

- If the total playing time is more than "99:59" or if one of the programmed tracks has a number greater than 30, then "- : - -" is displayed instead of the total playing time.
- If you attempt to program more than 40 tracks, "FULL" is displayed.
- During programming, if no button is pressed within 20 seconds, the system will exit the Program mode automatically.

To review the program

- Stop playback and press **◀** or **▶** repeatedly.
- To exit review mode, press **■**.

Erasing the program

- Press **■ once** when playback is stopped or **twice** during playback.
→ **PROG** disappears and "PROGRAM CLEARED" is displayed.

Note:

- The program will be erased when the system is disconnected from the power supply or when the disc tray is opened.

For Recording, please refer to "Tape Operation/Recording".

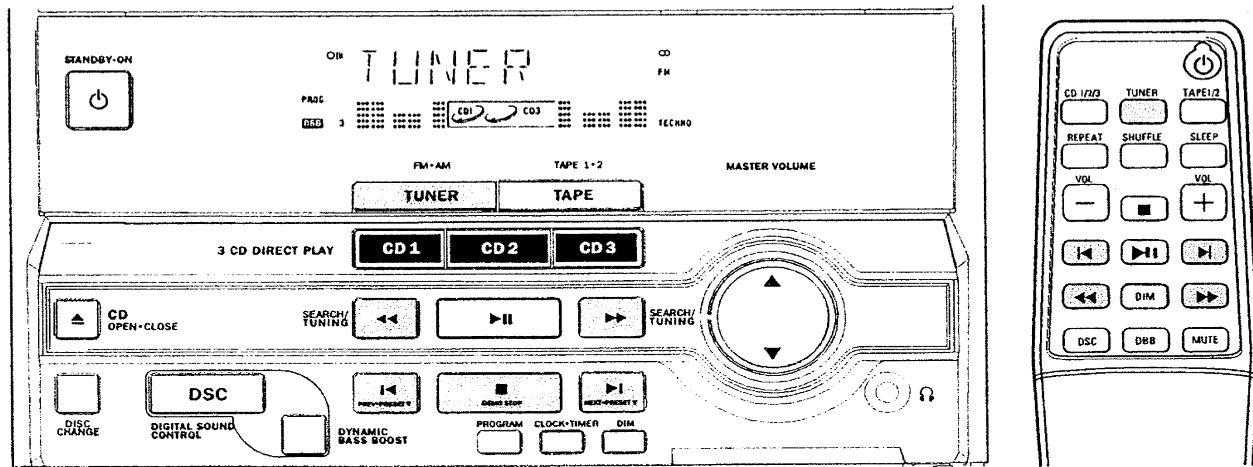

Tuning to radio stations

- 1 Press **TUNER** to select TUNER mode.
→ "TUNER" is displayed. A few seconds later, the current radio frequency will appear on the display.
→ If an FM station is received in stereo, ∞ is displayed.
 - 2 Press **TUNER** again to select the desired waveband : FM or AM.
 - 3 Press and hold \lll or \ggg until the frequency indication starts to change, then release.
→ The display will show "SEARCH" until a radio station with sufficient signal strength is found.
 - 4 Repeat step 3 if necessary until you find the desired radio station.
- To tune to a weak station, press \lll or \ggg briefly and repeatedly until optimal reception is found.

Storing preset radio stations

You can store up to 40 preset radio stations in the memory.

Automatic Preset Programming

- Plug and Play setting (refer to "Basic Functions - Plug and Play").
OR
- 1 Press **TUNER** to select TUNER mode.

To begin automatic preset from a desired preset number

- Press \lll or \ggg to select the desired preset number.
→ If a radio station has been stored in one of the presets, it will not be stored again under another preset number.
- 2 Press and hold **PROGRAM** until "AUTO" is displayed.
→ **PROG** starts flashing.
→ All available radio stations with sufficient signal strength will be stored automatically, starting from FM and followed by AM band.
→ When all the available radio stations are stored or the memory for 40 presets are used, the last preset radio station will be played.

To stop storing the automatic preset

- Press **PROGRAM** or \blacksquare on the system.

Note:

– If no preset number is selected, automatic preset will begin from preset (1) and all your former presets will be overridden.

Radio Reception

Manual Preset Programming

- 1 Tune to your desired radio station (refer to "Tuning to radio stations").
- 2 Press **PROGRAM**.
 - **PROG** starts flashing.
 - The next available preset number is displayed for selection.

To store the radio station to another preset number

- Press ◀ or ▶ to select the desired preset number.
- 3 Press **PROGRAM** again to store the radio station.
 - **PROG** disappears.
- Repeat **steps 1–3** to store other radio stations.

To exit manual preset mode

- Press ■ on the system.

Notes:

- If you attempt to store more than 40 preset radio stations, "FULL" is displayed.
- During programming, if no key is pressed within 20 seconds, the system will exit the Program mode automatically.

Tuning to preset radio stations

- Once you've programmed the radio stations, press ◀ or ▶ to select the desired preset number.
 - The preset number, radio frequency, and waveband are displayed.

Erasing a preset radio station

- 1 Press ◀ or ▶ to select the preset radio station to be erased.
 - 2 Press and hold ■ on the system until "PRESET DELETED" is displayed.
 - The deleted radio frequency remains on the display.
 - The preset numbers of all other preset radio stations in the band with higher numbers are also decreased by one.
- Repeat **steps 1–2** to erase other preset radio stations.

For Recording, please refer to "Tape Operation/Recording".

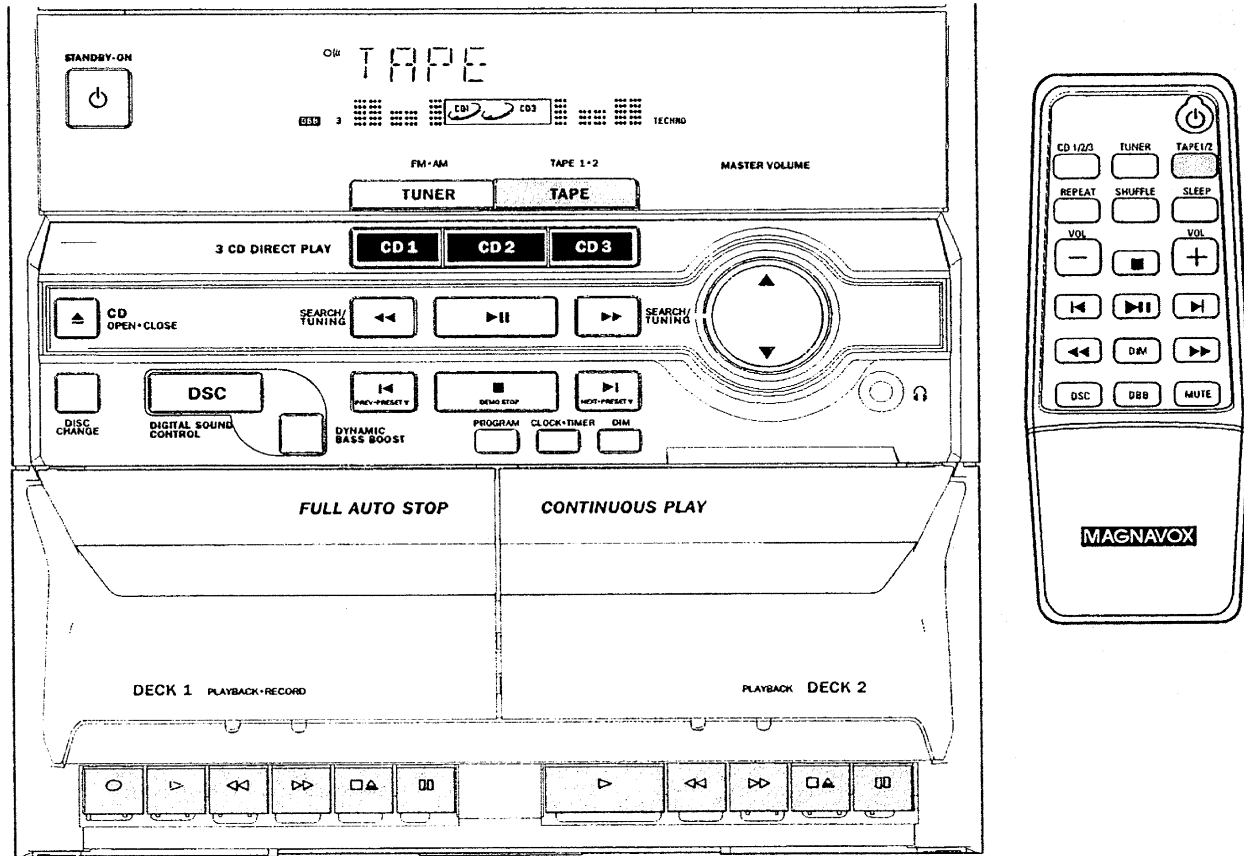

IMPORTANT!

- Before playing a tape, check and tighten slack tape with a pencil. Slack tape may jam or burst in the mechanism.
- C-120 tape is extremely thin and is easily deformed or damaged. It is not recommended for use in this system.
- Store the tapes at room temperature and do not put them too close to a magnetic field (for example, a transformer, TV or speaker).

Loading tape

- 1 Press **TAPE** to select TAPE mode.
→ "TAPPE" is displayed.
- 2 Press **▲** to open the tape deck door.
- 3 Load the tape with the open side downward and full spool to the left.
- 4 Close the tape deck door.

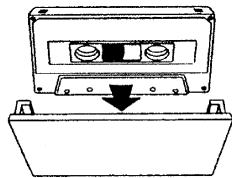

Playing tapes

To playback a selected tape deck

- Press **▶** on tape deck 1 or 2.
→ The tape will stop at the end of playback.

Continuous playback of two tapes

- 1 Load the tapes in tape deck 1 and 2.
- 2 Press **▶** on tape deck 2.
- 3 Press **||** on tape deck 1, followed by **▶**.
→ Playback will begin from tape deck 2 and continue with tape deck 1. It will stop at the end of tape deck 1.

To interrupt playback

- Press **||**.
- To resume playback, press **||** again.

To stop playback

- Press **▲**.

Tape Operation / Recording

Rewinding / Fast forwarding

- 1 Stop playback, press ◀◀ or ▶▶.
→ The tape will stop automatically at the end of rewinding or fast forwarding.
- 2 Press ■▲ to stop rewinding or fast forwarding.

Note:

– During rewinding or fast forwarding of a tape, it is also possible to select another source (CD or TUNER, for example).

General information on recording

- For recording, use only tape of IEC type I (normal tape).
- The recording level is set automatically, regardless of the position of the Volume, DBB, DSC and so forth.
- The tape is secured at both ends with leader tape. At the beginning and end of the tape, nothing will be recorded for six to seven seconds.
- To prevent accidental recording, break out the tab on the left shoulder of the tape side you want to protect.

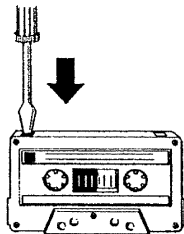

IMPORTANT!

- Recording is permissible if copyright or other rights of third parties are not infringed upon.
- Recording is possible only on tape deck 1.

Preparation for recording

- 1 Load a recordable tape into tape deck 1 with full spool to the left.
- 2 Prepare the source to be recorded.
CD 1/2/3 – load the disc(s).
TUNER – tune to the desired radio station.
TAPE – load the prerecorded tape into tape deck 2 with the full spool to the left.

When recording is in progress

→ REC starts flashing.

- It is not possible to listen to another source.
- It is not possible to activate the timer function during recording or tape dubbing.

One touch recording

- 1 Press **CD 1/2/3** or **TUNER** to select the source.
- 2 Start playback of the selected source.
- 3 Press ● on tape deck 1 to start recording.

To stop recording

- Press ■▲ on tape deck 1.

CD Synchronized start recording

- 1 Press **CD 1/2/3** to select the disc.
 - You can program the tracks in the order you want them to be recorded (refer to "CD Operation - Programming the disc tracks").
- 2 Press ● on tape deck 1 to start recording.
 - The disc will start playback automatically.

To stop recording

- Press ■▲ on tape deck 1, then press ■ to stop disc playback.

Note:

– During CD synchronized start recording, do not fast forward/rewind the tape in tape deck 2.

Dubbing tapes

- 1 Load the prerecorded tape in tape deck 2.
 - Make sure both tapes have their full spool to the left.
 - 2 Press **II** on tape deck 1 and followed by ●.
 - 3 Press **▶** on tape deck 2.
→ Recording will start automatically.
- Dubbing of tapes is possible on one side of the tape only. To continue recording on the reverse side, at the end of side A, flip the tape to side B and repeat the procedure.

To stop dubbing

- Press **■▲** on tape deck 1 and 2.

Notes:

- Dubbing of tapes is possible only from tape deck 2 to tape deck 1.
- To ensure good dubbing, use tapes of the same length.

Maintenance

Cleaning the Cabinet

- Use a soft cloth slightly moistened with a mild detergent solution. Do not use a solution containing alcohol, spirits, ammonia or abrasives.

Cleaning Discs

- When a disc becomes dirty, clean it with a cleaning cloth. Wipe the disc from the center out.
- Do not use solvents such as benzene, thinner, commercially available cleaners, or antistatic spray intended for analog records.



Cleaning the disc lens

- After prolonged use, dirt or dust may accumulate at the disc lens. To ensure good playback quality, clean the disc lens with Philips CD Lens Cleaner or any commercially available cleaner. Follow the instructions supplied with cleaner.

Cleaning the Heads and the Tape Paths

- To ensure good recording and playback quality, clean the heads (A) and (B), the capstan(s) (C), and pressure roller(s) (D) after every 50 hours of tape operation.
- Use a cotton swab slightly moistened with cleaning fluid or alcohol.
- You can also clean the heads by playing a cleaning tape once.

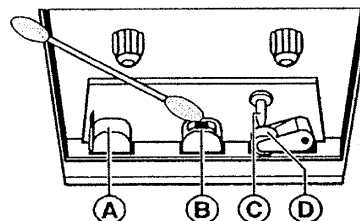

Demagnetizing the heads

- Use a demagnetizing tape available at your dealer.

Clock/Timer

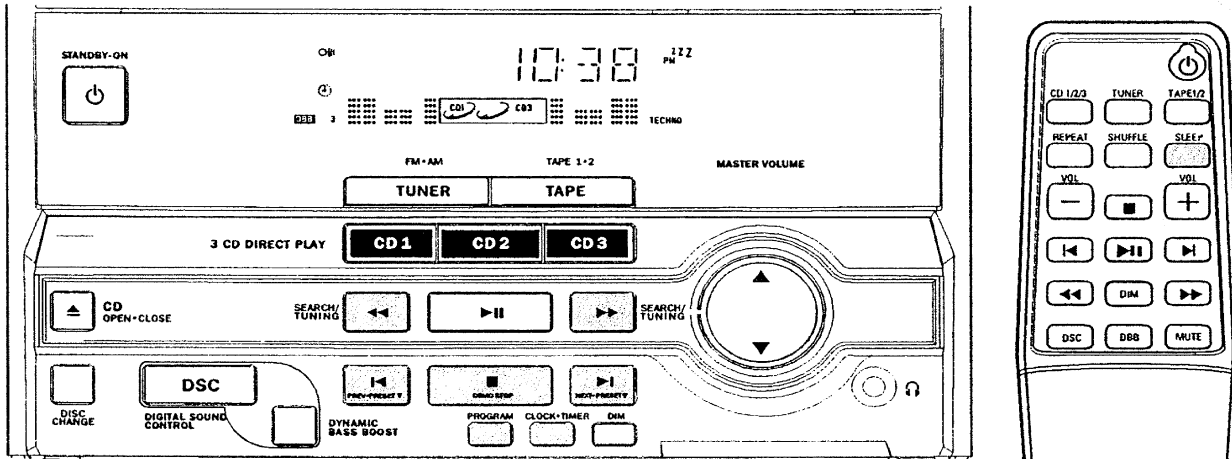

View clock

The clock (if it is set) will be shown in standby mode.

To view the clock in any source mode (CD or TUNER for example)

- Press **CLOCK•TIMER**.
 - The clock is displayed for a few seconds.
 - If the clock has not been set, "----:--" is displayed.

Clock setting

The clock can be set in either 12-hour or 24-hour mode ("12:00 AM" or "00:00", for example)

- 1 In standby or view clock mode, press **CLOCK•TIMER once**. In other source mode, press **CLOCK•TIMER twice**.
- 2 Press **PROGRAM** repeatedly to select clock mode.
 - "12:00 AM" or "00:00" starts flashing.
- 3 Press **◀** or **▶** on the system repeatedly to set the hour.
- 4 Press **◀** or **▶** on the system repeatedly to set the minute.
- 5 Press **CLOCK•TIMER** again to store the setting.
 - The clock starts working.

To exit without storing the setting

- Press **■** on the system.

Notes:

- The clock setting will be cancelled when the power cord is disconnected or if a power failure occurs.
- During clock setting, if no button is pressed within 90 seconds, the system will exit clock setting mode automatically.

Timer setting

The system can switch on to CD or TUNER mode automatically at a preset time, serving as an alarm to wake you up.

IMPORTANT!

- Before setting the timer, ensure that the clock is set correctly.
 - The timer will always be switched on after it has been set.
 - The timer will not start if a recording is in progress.
 - The volume of the timer controlled playback will increase gradually from the minimum level to the last tuned volume level.
- 1 Press and hold **CLOCK•TIMER** for more than **two seconds** to select timer mode.
 - "12:00 AM" or "00:00" or the last timer setting starts flashing.
 - **⏰** starts flashing.

- 2 Press **CD 1/2/3**, **TUNER** or **PROGRAM** to select the desired source.
 - "CD 1 [or 2, 3] XX:XX" indicates the CD mode is selected.
 - "TU XX:XX" indicates the Tuner mode is selected.
 - "PROG XX:XX" indicates the CD program mode is selected.
- Before setting timer, make sure the music source has been prepared.
 - CD 1/2/3** – Load the disc(s). To start from a specific track, make a program (refer to "CD Operation - Programming the disc tracks").
 - TUNER** – tune to the desired radio station.
- 3 Press ◀ or ▶ on the system repeatedly to set the hour for the timer to start.
- 4 Press ◀ or ▶ on the system repeatedly to set the minute for the timer to start.
- 5 Press **CLOCK•TIMER** to store the timer.
 - "TIMER ON" is displayed, followed by the set timer "XX:XX" and the selected source.
 - ⏸ remains on the display.
- At the preset time, the selected sound source will play.

To exit without storing the setting

- Press ■ on the system.

Notes:

- When the preset time is reached and the selected disc tray is empty, the next available disc will be selected. If all the disc trays are not available, Tuner will be selected automatically.
- During timer setting, if no button is pressed within 90 seconds, the system will exit timer setting mode automatically.

Deactivating the timer

- 1 Press and hold **CLOCK•TIMER** for more than **two seconds**.
- 2 Press ■ on the system to cancel the timer.
 - "CANCEL" is displayed and the ⏸ disappears.

Activating the timer (for the same preset time and source)

- 1 Press and hold **CLOCK•TIMER** for more than **two seconds**.
- 2 Press **CLOCK•TIMER** again to store.
 - The last set timer information is displayed for a few seconds and ⏸ is shown.

Sleep timer setting

The sleep timer enables the system to switch to standby mode automatically at a preset time.

- 1 Press **SLEEP** on the remote control repeatedly to select a preset time.
 - The selections are as follows (time in minutes):
15 → 30 → 45 → 60 → 90 → 120 → OFF → 15 ...
 - "SLEEP XX" or "OFF" is displayed. "XX" is the time in minutes.
- 2 When you reach the desired length of time, stop pressing the **SLEEP** button.
 - ZZZ is shown, except for "OFF" mode.
 - The sleep timer is now set. Before the system switches to standby mode, a countdown of 10 seconds is displayed.
"SLEEP 10" → "SLEEP 9" ... → "SLEEP 1" → "SLEEP"

To check the remaining length of time after sleep timer is activated

- Press **SLEEP** once.

To change the preset sleep timer

- Press **SLEEP** again while the remaining sleep timer is shown.
 - The display will show the next sleep timer options.

To deactivate the sleep timer

- Press **SLEEP** repeatedly until "OFF" is displayed, or press the **STANDBY ON** button.

Specifications

AMPLIFIER

Output power 4 W total power
..... 2 x 2 W RMS⁽¹⁾
Signal-to-noise ratio ≥ 67 dBA (IEC)
Frequency response 50 – 15000 Hz
Impedance loudspeakers 8 Ω
Impedance headphones 32 Ω -1000 Ω
(1) (8 Ω , 60 Hz – 12.5 kHz, 10% THD)

CD PLAYER

Number of programmable tracks 40
Frequency range 20 – 20000 Hz
Signal-to-noise ratio ≥ 80 dBA
Channel separation ≥ 60 dB (1 kHz)
Total harmonic distortion $< 0.003\%$

TUNER

FM wave range 87.5 – 108 MHz
AM wave range 530 – 1700 kHz
Number of presets 40
Antenna
FM 300 Ω dipole wire
AM Loop antenna

TAPE DECK

Frequency response
Normal tape (type I) 80 – 10000 Hz (8 dB)
Signal-to-noise ratio
Normal tape (type I) ≥ 48 dBA
Wow and flutter $\leq 0.35\%$ DIN

SPEAKERS

System double port bass reflex
Impedance 8 Ω
Woofer 1 x 4" full range
Dimensions (w x h x d)
..... 7.2 x 12.2 x 6.5 (inch)
..... 183 x 310 x 165 (mm)
Weight 3.4 pounds each
..... 1.6 kg each

GENERAL INFORMATION

Material Polystyrene
AC Power 120V / 60 Hz
Power Consumption
Active 24 W
Standby ≤ 11 W
Dimensions (w x h x d)
..... 13.00 x 12.20 x 10.43 (inch)
..... 330 x 310 x 265 (mm)
Weight (without speakers) 9.74 pounds
..... 4.4 kg

Subject to modification

WARNING

Under no circumstances should you try to repair the system yourself, as this will invalidate the warranty. Do not open the system as there is a risk of electric shock.

If a fault occurs, first check the points listed below before taking the system for repair. If you are unable to solve a problem by following these hints, consult your dealer or service center.

Problem

Solution

CD OPERATION

"NO DISC" is displayed.

- Insert a disc.
- Check if the disc is inserted upside down.
- Wait until the moisture condensation at the lens has cleared.
- Replace or clean the disc, see "Maintenance".

"DISC NOT FINALIZED" is displayed.

- Use a finalized CD-RW or CD-R.

RADIO RECEPTION

Radio reception is poor.

- If the signal is too weak, adjust the antenna or connect an external antenna for better reception.
- Increase the distance between the Mini HiFi System and your TV or VCR.

TAPE OPERATION/RECORDING

Recording or playback cannot be made.

- Clean deck parts, see "Maintenance".
 - Use only NORMAL (IEC I) tape.
 - Apply a piece of adhesive tape over the missing tab space.
-

Troubleshooting

GENERAL

The system does not react when buttons are pressed.	<ul style="list-style-type: none">- Remove and reconnect the AC power plug and switch on the system again.
Sound cannot be heard or is of poor quality.	<ul style="list-style-type: none">- Adjust the volume.- Disconnect the headphones.- Check that the speakers are connected correctly.- Check if the stripped speaker wire is clamped.
The left and right sound outputs are reversed.	<ul style="list-style-type: none">- Check the speaker connections and location.
The remote control does not function properly.	<ul style="list-style-type: none">- Select the source (CD 1/2/3 or TUNER, for example) before pressing the function button (▶, ◀, ▶).- Reduce the distance between the remote control and the system.- Insert the batteries with their polarities (+/- signs) aligned as indicated.- Replace the batteries.- Point the remote control directly towards the IR sensor.
The timer is not working.	<ul style="list-style-type: none">- Set the clock correctly.- Press and hold CLOCK•TIMER to switch on the timer.- If recording or tapes dubbing is in progress, stop recording.
The Clock/Timer setting is erased.	<ul style="list-style-type: none">- Power has been interrupted or the power cord has been disconnected. Reset the clock/timer.
The system displays features automatically.	<ul style="list-style-type: none">- Press and hold ■ on the system to switch off the demonstration.

LIMITED WARRANTY

MAGNAVOX AUDIO SYSTEM

One Year Free Exchange

This product must be carried in for an exchange.

WHO IS COVERED?

You must have proof of purchase to exchange the product. A sales receipt or other document showing that you purchased the product is considered proof of purchase. Attach it to this owner's manual and keep both nearby.

WHAT IS COVERED?

Warranty coverage begins the day you buy your product. For one year thereafter, a defective or inoperative product will be replaced with a new, renewed, or comparable product at no charge to you. A replacement product is covered only for the original warranty period. When the warranty on the original product expires, the warranty on the replacement product also expires.

WHAT IS EXCLUDED?

Your warranty does not cover:

- labor charges for installation or setup of the product, adjustment of customer controls on the product, and installation or repair of antenna systems outside of the product.
- product repair and/or part replacement because of misuse, accident, unauthorized repair or other cause not within the control of Magnavox.
- reception problems caused by signal conditions or cable or antenna systems outside the unit.
- a product that requires modification or adaptation to enable it to operate in any country other than the country for which it was designed, manufactured, approved and/or authorized, or repair of products damaged by these modifications.
- incidental or consequential damages resulting from the product. (Some states do not allow the exclusion of incidental or consequential damages, so the above exclusion may not apply to you. This includes, but is not limited to, prerecorded material, whether copyrighted or not copyrighted.)
- a product that is used for commercial or institutional purposes.

WHERE IS EXCHANGE AVAILABLE?

You may exchange the product in all countries where the product is officially distributed by Magnavox. In countries where Magnavox does not distribute the product, the local Magnavox service organization will attempt to provide a replacement product (although there may be a delay if the appropriate product is not readily available).

BEFORE REQUESTING EXCHANGE...

Please check your owner's manual before requesting an exchange. Adjustments of the controls discussed there may save you a trip.

EXCHANGING A PRODUCT IN U.S.A., PUERTO RICO, OR U.S. VIRGIN ISLANDS...

Contact your dealer to arrange an exchange. Or, ship the product, insured and freight prepaid, and with proof of purchase enclosed, to the address listed below.

Small Product Service Center
Magnavox
1001 Snapps Ferry Road
Plant 2, Building 6
Greeneville, TN 37743

(In U.S.A., Puerto Rico, and U.S. Virgin Islands, all implied warranties, including implied warranties of merchantability and fitness for a particular purpose, are limited in duration to the duration of this express warranty. But, because some states do not allow limitations on how long an implied warranty may last, this limitation may not apply to you.)

EXCHANGING A PRODUCT IN CANADA...

Please contact Magnavox at:

1-800-661-6162 (French Speaking)

1-800-705-2000 (English Speaking or Spanish Speaking)

(In Canada, this warranty is given in lieu of all other warranties. No other warranties are expressed or implied, including any implied warranties of merchantability or fitness for a particular purpose. Magnavox is not liable under any circumstances for any direct, indirect, special, incidental or consequential damages, howsoever incurred, even if notified of the possibility of such damages.)

REMEMBER...

Please record below the model and serial numbers found on the product. Also, please fill out and mail your warranty registration card promptly. It will be easier for us to notify you if necessary.

MODEL # _____

SERIAL # _____

This warranty gives you specific legal rights. You may have other rights which vary from state/province to state/province.

824000934231

Magnavox, P.O. Box 520890, Miami, FL 33152 (402) 536-4171

EL6519E001 / 3-02

Free Manuals Download Website

<http://myh66.com>

<http://usermanuals.us>

<http://www.somanuals.com>

<http://www.4manuals.cc>

<http://www.manual-lib.com>

<http://www.404manual.com>

<http://www.luxmanual.com>

<http://aubethermostatmanual.com>

Golf course search by state

<http://golfingnear.com>

Email search by domain

<http://emailbydomain.com>

Auto manuals search

<http://auto.somanuals.com>

TV manuals search

<http://tv.somanuals.com>