

OWNER'S MANUAL

MAGNAVOX

Smart. Very smart.®

19MDTR20/27MDTR20

*COLOR TV WITH BUILT-IN VCR
AND DVD PLAYER*



NEED HELP? CALL US!

MAGNAVOX REPRESENTATIVES ARE READY TO HELP YOU WITH ANY QUESTIONS ABOUT YOUR NEW PRODUCT. WE CAN GUIDE YOU THROUGH CONNECTIONS, FIRST-TIME SETUP, AND ANY OF THE FEATURES. WE WANT YOU TO START ENJOYING YOUR NEW PRODUCT RIGHT AWAY.

**CALL US BEFORE YOU CONSIDER RETURNING THE PRODUCT.
1-800-705-2000**

OR VISIT US ON THE WEB AT WWW.MAGNAVOX.COM



IMPORTANT!
*RETURN YOUR WARRANTY REGISTRATION CARD WITHIN 10 DAYS.
SEE WHY INSIDE.*

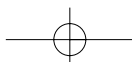

Return your Warranty Registration card today to ensure you receive all the benefits you're entitled to.

Once your MAGNAVOX purchase is registered, you're eligible to receive all the privileges of owning a MAGNAVOX product. So complete and return the Warranty Registration Card enclosed with your purchase at once. And take advantage of these important benefits.

Warranty Verification

Registering your product within 10 days confirms your right to maximum protection under the terms and conditions of your MAGNAVOX warranty.

Owner Confirmation

Your completed Warranty Registration Card serves as verification of ownership in the event of product theft or loss.

Model Registration

Returning your Warranty Registration Card right away guarantees you'll receive all the information and special offers which you qualify for as the owner of your model.

Congratulations on your purchase, and welcome to the "family!"



Dear MAGNAVOX product owner:

Thank you for your confidence in MAGNAVOX. You've selected one of the best-built, best-backed products available today. And we'll do everything in our power to keep you happy with your purchase for many years to come.

As a member of the MAGNAVOX "family," you're entitled to protection by one of the most comprehensive warranties and outstanding service networks in the industry.

What's more, your purchase guarantees you'll receive all the information and special offers for which you qualify, plus easy access to accessories from our convenient home shopping network.

And most importantly you can count on our uncompromising commitment to your total satisfaction.

All of this is our way of saying welcome-and thanks for investing in a MAGNAVOX product.

P.S. Remember, to get the most from your MAGNAVOX product, you must return your Warranty Registration Card within 10 days. So please mail it to us right now!

Know these safety symbols



⚡ This "bolt of lightning" indicates uninsulated material within your unit may cause an electrical shock. For the safety of everyone in your household, please do not remove product covering.

⚠ The "exclamation point" calls attention to features for which you should read the enclosed literature closely to prevent operating and maintenance problems.

WARNING: TO PREVENT FIRE OR SHOCK HAZARD, DO NOT EXPOSE THIS EQUIPMENT TO RAIN OR MOISTURE.

CAUTION: To prevent electric shock, match wide blade of plug to wide slot, fully insert.

ATTENTION: Pour éviter les choc électriques, introduire la lame la plus large de la fiche dans la borne correspondante de la prise et pousser jusqu'au fond.

For Customer Use

Enter below the Serial No. which is located on the rear of the cabinet. Retain this information for future reference.

Model No. _____
Serial No. _____

Visit our World Wide Web Site at <http://www.magnavox.com>

Safety and General Information 3

Safety Precautions

Warning: To prevent fire or shock hazard, do not expose this equipment to rain or moisture.

Federal Communications Commission (FCC) Warning: Any unauthorized changes or modifications to this equipment void the user's authority to operate it.

Laser Safety: This unit employs a laser. Only a qualified service person should remove the cover or attempt to service this device, due to possible eye injury.

CAUTION: USE OF CONTROLS OR ADJUSTMENTS OR PERFORMANCE OF PROCEDURES OTHER THAN THOSE SPECIFIED HEREIN MAY RESULT IN HAZARDOUS RADIATION EXPOSURE.

CAUTION: VISIBLE AND INVISIBLE LASER RADIATION WHEN OPEN AND INTERLOCK DEFEATED. DO NOT STARE INTO BEAM. THE BEAM IS LOCATED INSIDE, NEAR THE DECK MECHANISM.

Special Information for Canadian Users: This Class B digital apparatus complies with Canadian ICES-003. Cet appareil numérique de la classe B est conforme à la norme NMB-003 du Canada.

Radio/TV Interference: This equipment has been tested and found to comply with the limits for a Class B digital device, pursuant to Part 15 of the FCC Rules. These limits are designed to provide reasonable protection against harmful interference in a residential installation. This equipment generates, uses, and can radiate radio frequency energy and, if not installed and used in accordance with the instructions, may cause harmful interference to radio communications. However, there is no guarantee that interference will not occur in a particular installation. If this equipment does cause harmful interference to radio or television reception, which can be determined by turning the equipment off and on, the user is encouraged to try to correct the interference by one or more of the following measures:

- 1) Reorient or relocate the receiving antenna.
- 2) Increase the separation between the equipment and the receiver.
- 3) Connect the equipment into an outlet on a circuit different from that to which the receiver is connected.
- 4) Consult the dealer or an experienced radio/TV technician for help.

Copyright Protection: Unauthorized copying, broadcasting, public performance and lending of Discs are prohibited. This product incorporates copyright protection technology that is protected by method claims of certain U.S. patents and other intellectual property rights owned by Macrovision Corporation and other rights owners. Use of this copyright protection technology must be authorized by Macrovision Corporation and is intended for home and other limited viewing uses only unless otherwise authorized by Macrovision Corporation. Reverse engineering or disassembly is prohibited.

Note to the Cable TV System Installer: This reminder calls the Cable TV system installer's attention to Article 820-40 of the National Electrical Code, which provides guidelines for proper grounding – in particular, specifying that the cable ground shall be connected to the grounding system of the building, as close to the point of cable entry as possible.

Declaration of Conformity

Model Number: 19MDTR20/27MDTR20
 Trade Name: Magnavox
 Responsible Party: Philips Consumer Electronics
 P.O. Box 14810
 Knoxville, TN 37914-1810
 (865) 521-4316



As an ENERGY STAR® Partner, Magnavox has determined that this product meets the ENERGY STAR® guidelines for energy efficiency. ENERGY STAR® is a U.S. registered mark. Using products with the ENERGY STAR® label can save energy. Saving energy reduces air pollution and lowers utility bills.

Manufactured under license from Dolby Laboratories. "Dolby" and the double-D symbol are trademarks of Dolby Laboratories. Copyright 2003 Magnavox. All rights reserved.

4 Table of Contents

General Information

Safety and General Information	3
Table of Contents	4
Introduction	5
Playable Discs and Videotapes	6

First-Time Setup and Use

Before Using the TV/VCR/DVD	7
Hooking Up the TV/VCR/DVD	8-9
Optional Connections	10
First-Time Setup, Watching TV	11
Playing a Videotape	12
Playing a Disc	13

Description of Controls

Remote Control Buttons	14-15
Front Panel	16
Rear Panel	17

TV Settings

Menu Language, Resetting TV Channels	18
Adding/Deleting Channels	19
Setting the Clock	20-23
Daylight-Savings Time	24
Status Displays, Picture Controls	25

Recording

Videotape Recording	26
One-Touch Recording	27
Timer Recording	28-31
Timer Recording Auto Return	32
Rerecording (Tape Duplication)	33

Videotape Features

Repeat Play	34
Rental Play	35
Zero Return, Sleep Timer	36
Time Search	37
Index Search	38
Videotape Playback Features	39
Automatic Operation Features	40

Additional TV Features

Closed Captions	41
Setting V-Chip	42-47
Multi-Channel Television Sound	48-50

Disc Features

Disc Menus, Title Menus	51
Fast Forward/Reverse Search	52
Title/Chapter Playback, Time Playback	53
Track Play	54
Paused and Step-by-Step Play, Resume On	55
Repeat Play, A-B Repeat Play	56
Markers	57
Subtitles, Camera Angles	58
Slow Motion, Zoom	59
Parental Password	60-61
Parental Levels	62-63
Audio Language, Stereo Sound	64
Random Play, Programmed Play	65
MP3/JPEG Playback	66
MP3/JPEG Displays	67

DVD Setup Features

Language Settings	68-69
Display Settings	70-71
Audio Settings	72
On-Screen Displays	73
Black Level, Virtual Surround	74

Information You May Need

Glossary	75
Helpful Hints	76-77
Specifications	78
Limited Warranty	79
Index	80

Introduction 5

Welcome to your TV/VCR/DVD owner's manual.

This manual describes the 19MDTR20 and 27MDTR20. These two models are different sizes, but they operate identically. The 27MDTR20 is illustrated in this manual.

Features - TV/VCR

- Automatic Channel Setup
- Automatic Head Cleaner
- Automatic Tracking Adjustment
- Closed Captions
- Daylight-Savings Time
- English, Spanish, or French Setup Menus
- Forward/Reverse Searching; Still
- High Quality (HQ) System
- Index Search
- One-Touch Recording
- Real-Time Videotape Counter
- Rental Play
- Repeat Play
- Sleep Timer
- Time Search
- Timer Recording
- V-Chip (Parental Controls)
- Zero Return

Features - Discs

- Audio Language choices*
 - Bit Rate display
 - Camera Angle*
 - Dolby Digital Sound*
 - Dynamic Range Control
 - Fast/Paused/Slow/Step-by-Step Playback
 - Markers
 - Parental Controls*
 - Programmed Play (Audio CD, MP3)
 - Random Play (Audio CD, MP3)
 - Repeat (A-B, Chapter, Title, Track, Disc)
 - Search (Title/Chapter, Time, Track)
 - Subtitles*
 - Virtual Surround
 - Zoomed Play
- * If available on the Disc

DVD Disc Menus...

Some explanations in this manual describe DVD Disc menus. DVD manufacturers set the menus, which vary among DVDs. All DVDs do not have menus. If the DVD has a menu, access it by pressing the DISC MENU button on the remote control. Details are on page 51.

Setup Menus...

Some instructions explain how to use the setup menus of the TV/VCR/DVD. There are two setup menus: one for the TV/VCR features while the unit is in TV/VCR mode, and one for the Disc features while the unit is in DVD mode. Access the setup menus by pressing SETUP on the remote control.

While in TV/VCR mode, you can select only the TV/VCR SETUP menu.

In DVD mode, you can select both the TV/VCR SETUP menu and the SETUP menu for the unit's DVD Player. Press the SETUP button once to select the TV/VCR SETUP menu. Press SETUP twice to get to the DVD Player's SETUP menu.

Even if you set a DVD feature in the unit's SETUP menu, it will not be available if the current Disc does not include that feature.

Available Disc Features...



All features described in this manual are not available on every Disc. If the feature is not available on the Disc, you cannot use the TV/VCR/DVD to make it available.

An "X" will appear in the top right corner of the screen if you try to access a feature that is not available.

For example, some features are available only during play, while others are available only if play is stopped. If you cannot access a feature, try stopping or starting play, then try the feature again.

6 Playable Discs and Videotapes

Playable Discs

The DVD Player of this TV/VCR/DVD will play many types of Discs, including Digital Video Discs (DVDs) and Audio Compact Discs (CDs). It will play MP3 and JPEG files as well.

To play a DVD, make sure it meets the requirements for Region Codes and Color Systems as described below. Discs that have the following logos will play on the DVD Player of this TV/VCR/DVD. Finalize CD-R, CD-RW, DVD+R, and DVD+RW Discs before playing them in the TV/VCR/DVD.



DVD: Prerecorded Digital Video Discs



CD-R: Compact Disc Recordable. CD-Rs can be recorded on only once.



Audio CDs



DVD+R: DVD Recordable. DVD+Rs can be recorded on only once.



MP3: Digital audio files recorded on a CD-R or CD-RW



DVD+RW: DVD Rewritable. DVD+RWs can be recorded on multiple times.



CD-RW: Compact Disc Rewritable. CD-RWs can be recorded on multiple times.

Region Codes

This TV/VCR/DVD has a Region One (1) DVD Player. DVDs must be labeled for ALL regions or for Region 1 in order to play on the unit. You cannot play DVDs that are labeled for other regions. Look for the symbols below on your DVDs. If these region symbols do not appear on your DVD, you cannot play the DVD in this TV/VCR/DVD.



The number inside the globe refers to a region of the world. Region 1 represents the United States, Canada, upper regions of North America, Bermuda, the U.S. Virgin Islands, and small regions near Australia.

A DVD labelled for a specific region can only play on DVD Players with the same region code.

Color Systems

DVDs are recorded in different color systems throughout the world. The most common color systems are NTSC (which is used primarily in the United States and North America), PAL, and SECAM.

The DVD Player of this unit uses NTSC, so DVDs you play must be recorded in the NTSC color system. You cannot play DVDs recorded in other formats. The color system of the DVD may be listed on the DVD or on the Disc case.

Videotapes

Magnavox recommends you use only videotapes that have the **VHS** mark. Other videotapes may have poor picture quality and cause excessive deposits on the video heads. The warranty may not cover such damage.

The VCR of this TV/VCR/DVD has a High Quality (HQ) system and is compatible with existing Video Home System (VHS) equipment.

Before Using the TV/VCR/DVD 7

Remote Control Battery Installation

- 1** Remove the battery compartment lid on the bottom of the remote control. Slide the lid down and off. Follow the direction of the arrow on the lid.
- 2** Place two AA batteries inside the battery compartment. Align the + and - ends as indicated.
- 3** Replace the battery compartment lid.

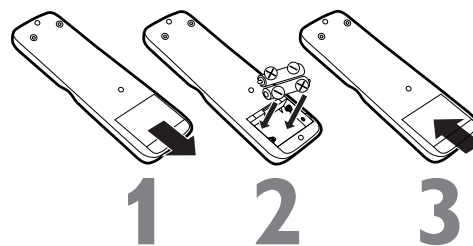

Battery Safety

Battery Usage CAUTION - To prevent battery leakage that may result in bodily injury, property damage, or damage to the unit:

- Install ALL batteries correctly, with the + and - markings on the battery aligned as indicated on the unit;
- Do not mix batteries, for example, old with new or carbon with alkaline; and
- Remove batteries when the unit will not be used for a long time.

Recording Prevention

Videotapes have record tabs to ensure you do not erase recordings accidentally.

- 1** To prevent accidental recording, break off the tab with a screwdriver.
- 2** To record again, cover the hole with cellophane tape.

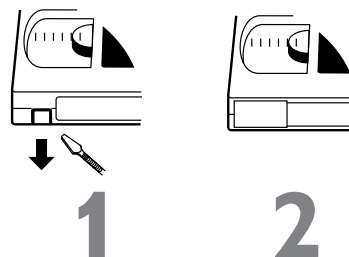

Using the Remote Control

- Point the remote control at the remote sensor on the front of the TV/VCR/DVD. Details are on page 16.
- Do not put objects between the remote control and the TV/VCR/DVD.

TV/VCR/DVD Maintenance

- Remove any light adhesive stick-on notes from the video cassette before putting the cassette in the TV/VCR/DVD. Removable labels can jam the TV/VCR/DVD.
- The TV/VCR/DVD requires periodic maintenance to maintain its excellent performance. This TV/VCR/DVD has an internal head cleaning system. However, the video heads will eventually require cleaning or replacement. Only an authorized service center should perform this service.

Helpful Hint

- Your new product, its packaging, and this manual contain materials that can be recycled and reused. Specialized companies can recycle your product to increase the amount of reusable materials and to minimize the amount that needs to be properly disposed. Your product uses batteries that should not be thrown away when depleted but should be disposed of as small chemical waste. Please find out about the local regulations on disposal of your old product, batteries, manual, and packaging when you replace existing equipment.

8 Hooking Up the TV/VCR/DVD

1 Hook up your TV/VCR/DVD using one of the connections shown.

A Hooking Up Your TV/VCR/DVD with a Cable TV Signal or Outdoor Antenna

Connect a Cable TV signal or an antenna to the ANT(enna) Jack.

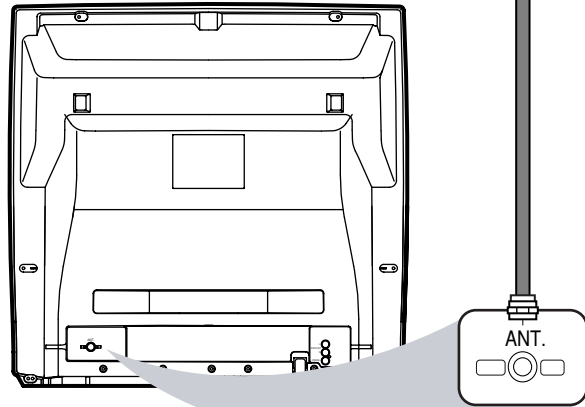

B Hooking Up Your TV/VCR/DVD with a Cable Box/Satellite Receiver

To view any channel, set the TV/VCR/DVD to the output channel (channel 03 or 04) of the Cable Box/Satellite Receiver. Then, select channels at the Cable Box/Satellite Receiver.

Connect the Cable TV or Satellite signal to the IN Jack on the Cable Box/Satellite Receiver.

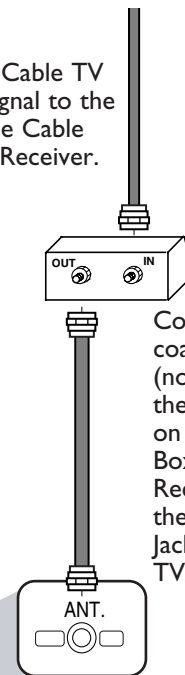
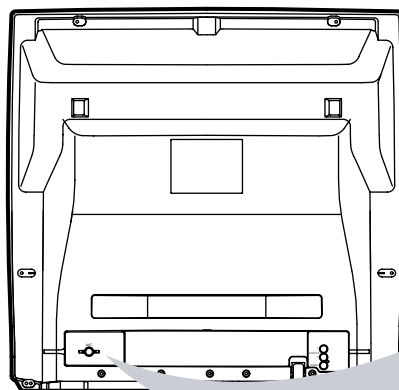

Connect an RF coaxial cable (not supplied) to the OUT Jack on the Cable Box/ Satellite Receiver and to the ANT(enna) Jack on the TV/VCR/DVD.

Your Cable Box/Satellite Receiver may have Audio and Video Out jacks instead of the single Antenna Out jack (RF coaxial or 75 ohm) shown here. If so, connect Audio and Video cables to the Audio/Video Out jacks of the Cable Box/Satellite Receiver and to the AUDIO/VIDEO In jacks on the front of the TV/VCR/DVD. Press SELECT on the remote to set the TV/VCR/DVD to AUX, not channel 3 or 4. Select channels you want to watch or record at the Cable Box/Satellite Receiver as usual, leaving the TV/VCR/DVD on AUX.

Hooking Up the TV/VCR/DVD (cont'd) 9

C Hooking Up Your TV/VCR/DVD with an Indoor Antenna

To install an indoor antenna or "rabbit ears" (not supplied), connect the antenna wire to the ANT(enna) Jack on the back of the TV/VCR/DVD as shown. Extend the antenna and adjust its length, direction, and angle for the clearest picture.

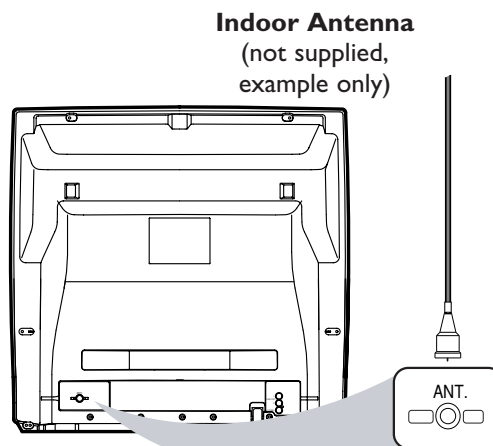

D Hooking Up Your TV/VCR/DVD to Another Video Source (VCR, DVD Player, Camcorder, etc.)

You may need this connection if you want to play Discs or tapes on other equipment but watch them on the TV/VCR/DVD. Press SELECT on the remote to select AUX at the TV/VCR/DVD. When you play the materials on the other equipment, it will show on the TV/VCR/DVD's AUX channel. *More details are on page 33.*

Audio and video cables are not supplied.

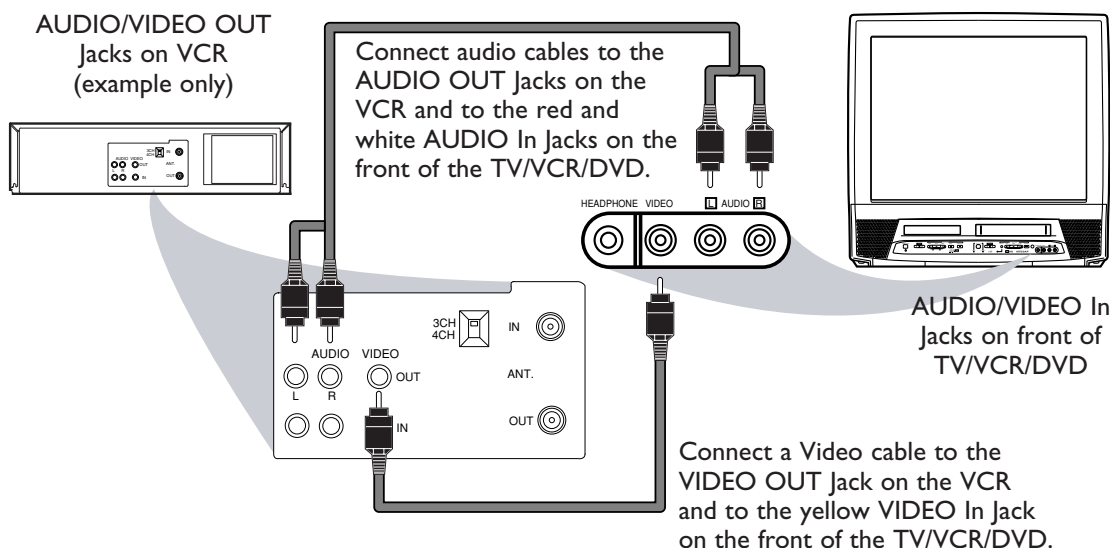

2 When all other connections are complete, plug in the TV/VCR/DVD's power cord.

3 Before you turn on the TV/VCR/DVD, go to page 11.

10 Optional Connections

Analog Stereo Hookups

If you want to hear the TV/VCR/DVD sound through a stereo instead, make this connection.

- 1** Complete the antenna/Cable TV connections. Details are on pages eight-nine.
- 2** Connect red and white audio cables to the red and white AUDIO OUT jacks on the back of the TV/VCR/DVD and to the AUDIO IN jacks on the stereo. Match the cable colors to the jack colors. Audio cables are not supplied. Use RCA-style cables.
- 3** Set your stereo to Auxiliary In or the correct "Source" mode. See your stereo owner's manual for details.

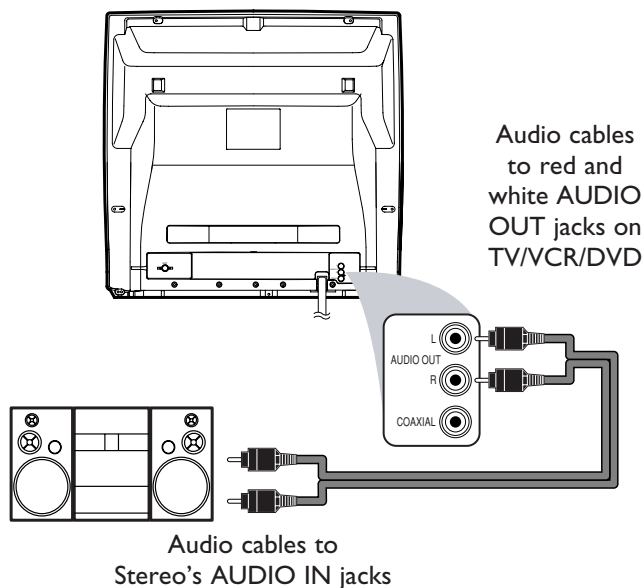

Digital Stereo Hookups

You can connect the TV/VCR/DVD to a Stereo that has a Digital Coaxial In jack. Use this hookup if you want to hear the TV/VCR/DVD sound through the Stereo instead. Use these connections for a Dolby Digital-compatible Stereo or for a Receiver that has a Mini-Disc or Digital Audio Tape deck.

- 1** Connect the antenna/Cable TV signal. Details are on pages eight-nine.
- 2** Connect a digital audio coaxial cable (not supplied) to the orange COAXIAL jack on the TV/VCR/DVD. Also connect the cable to the Stereo's COAXIAL DIGITAL AUDIO IN jack.
- 3** If the Stereo is Dolby Digital-compatible, set DOLBY DIGITAL to ON. If the Stereo is not Dolby Digital-compatible or if you connected to a Mini-Disc or Digital Audio Tape Deck, set DOLBY DIGITAL to OFF. Details are on page 72.
An incorrect setting causes noise distortion and damages speakers.
To see if your Stereo has Dolby Digital, look for a Dolby Digital logo on your Stereo. Or, refer to the Stereo owner's manual.

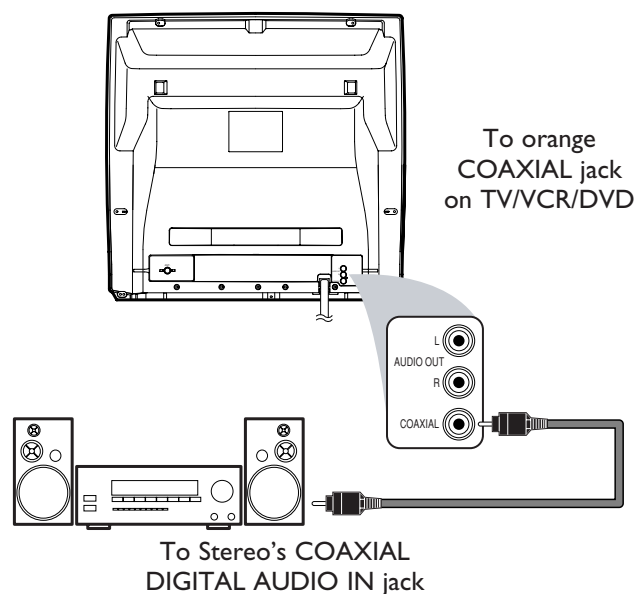

Helpful Hints

- You cannot use a Mini-Disc or Digital Audio Tape deck to copy 5.1 channel Dolby Digital surround sound Discs.
- Discs recorded in Dolby Digital should show this on the Disc or case. If the Disc is not recorded in 5.1 channel Dolby Digital surround sound, you will not hear multi-channel sound even if you use the Digital Stereo hookup.

12 Playing a Videotape

Follow these steps to simply play a videotape. Videotape playback options are on pages 34-40.

- 1** Insert a videotape in the cassette compartment of the TV/VCR/DVD. The power will come on. If the tape's record tab is missing, play should start automatically.
- 2** If play does not start automatically, press **PLAY ►** to start play.
- 3** Press **STOP ■** to stop play.
- 4** Press **◀◀ / ◀◀** to rewind the tape.
- 5** When the tape finishes rewinding, press **STOP/EJECT** on the front of the TV/VCR/DVD to remove the tape.

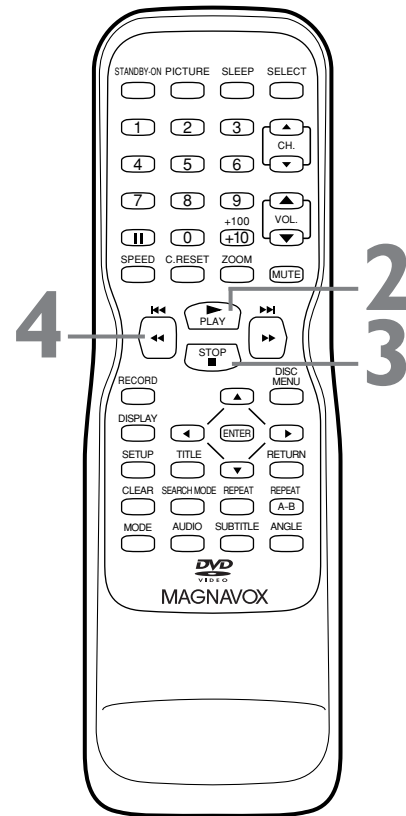

Helpful Hints





- If the tape you want to play is already in the TV/VCR/DVD, turn on the power. Press **SELECT** to choose TV/VCR mode (the red VCR/TV light will be on), then press **PLAY ►**.
- When you play an S-VHS format tape, you cannot get the high resolution that would be available on an S-VHS VCR. Noise lines (black and white streaks) may appear in the picture.
- If you press **SELECT** while playing a videotape, play will stop and the unit will switch to DVD mode. This will happen also if you press **PLAY ►** (DVD) or **OPEN/CLOSE ▲** (DVD) on the front of the TV/VCR/DVD during videotape playback.

Playing a Disc 13

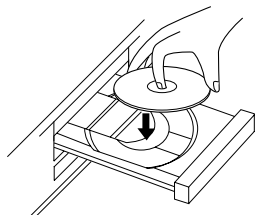
Before you begin, turn on the power of other equipment connected to the TV/VCR/DVD. Set a stereo (if applicable) to the correct sound source or channel. *Details are on page 10.*

- 1** Press **STANDBY-ON** to turn on the **TV/VCR/DVD**. The unit will be in TV/VCR mode. The red VCR/TV light will be on.
- 2** Press **SELECT** to put the **TV/VCR/DVD** in **DVD mode**. The green DVD light will appear on the front of the TV/VCR/DVD.
- 3** Press **OPEN/CLOSE**  on the front of the **TV/VCR/DVD** to open the **Disc tray**.
- 4** Place a **Disc** into the tray.
Some DVDs are recorded on both sides. Make sure the label of the side you want to play is facing up.
Or, if the DVD is recorded on only one side, place the Disc in the tray with the label facing up and the shiny side facing down.



- 5** Press **PLAY** . The tray will close and play will begin. If play does not start, press **PLAY**  again. Or, you can press **OPEN/CLOSE**  or press the tray toward the unit to close the tray. If a DVD Disc menu appears instead, see page 51. For MP3 and JPEG details, see page 66.
- 6** Press **STOP**  to stop play. If play remains stopped for five minutes, the DVD screen will dim. If play is stopped for 20 minutes with no activity at the TV/VCR/DVD, the unit will turn off.

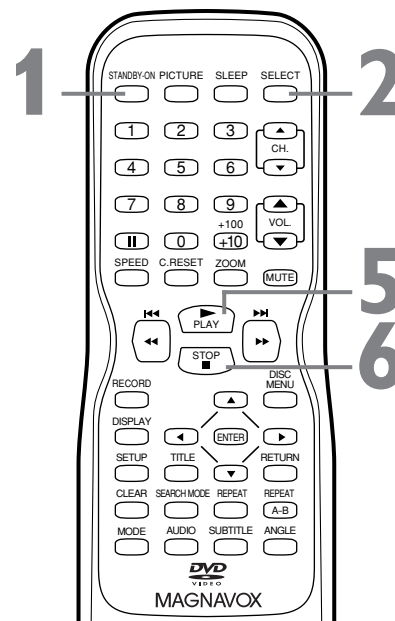

Remember, only certain Discs will play.
See page six for details.



- 3** Press **OPEN/CLOSE**  on the front of the **TV/VCR/DVD**.

- 4** Insert a Disc.

Helpful Hints

- If you turn off the unit in DVD mode, when you turn it on again, it will be in TV/VCR mode.
- An "X" will appear on the screen when you try to access a feature that is not available. This is not a problem with the TV/VCR/DVD.
- If a Disc is dirty or scratched, the picture may be distorted or play may stop. Remove the Disc and try a different one.
- Press **OPEN/CLOSE**  (DVD) or **PLAY**  (DVD) on the front of the TV/VCR/DVD when the power is off. This turns on the unit in DVD mode (not TV/VCR mode).
- If a Disc has multiple layers, the picture may freeze occasionally. This happens when the first layer switches to the second layer. This is not a malfunction.
- Pressing **SELECT** during Disc play stops Disc play and switches the unit to TV/VCR mode. Pressing **PLAY**  (VCR) on the front of the unit during Disc play stops Disc play and starts tape play.

14 Remote Control Buttons

PICTURE Button

Press to access the picture controls.
Details are on page 25.

STANDBY-ON Button

Press to turn on or off the TV/VCR/DVD.

Number Buttons

TV Mode: Press two digits to access a specific channel. Press 0 before the number of a single-digit channel. Details are on page 11.
+100/+10 button: To select channels 100 or higher, press +100/+10, then the Number buttons of the last two digits of the channel number.

DVD Mode: Use the Number buttons to enter a Track or Chapter number.

+100/+10 button: Press before entering double-digit numbers. For example, to select Chapter 16, press +100/+10, then 1, 6.

II (pause) Button

Press to pause videotape recording. Press again to resume recording. Details are on page 26.
Press to pause videotape or DVD playback. Press repeatedly to advance the picture one frame at a time. Details are on pages 39 and 55.

RECORD Button

Press once to start a recording on videotape. Details are on page 26.

DISPLAY Button

TV/VCR Mode: Press to see the videotape counter, channel, or time on the screen. Details are on page 25.

DVD Mode: Press to see the Disc status on the screen. Details are on page 73.

TITLE Button

Press to access a DVD's Title menu if available. Details are on page 51.

SLEEP Button

Press to set the Sleep Timer. Details are on page 36.

SELECT Button

Press to choose TV/VCR or DVD mode. The corresponding light will appear on the front of the TV/VCR/DVD to indicate which mode is active. Details are on page 16.

PLAY ► Button

Press to start playing a Disc or video cassette. Details are on pages 12-13.

▶▶ / ▶▶▶ Button

During Disc playback, press briefly to skip to the next Track or Chapter. Details are on page 54.
Or, press and hold for two seconds to search forward during Disc playback. Details are on page 52.
Press to forward a videotape. Details are on page 39.

STOP ■ Button

Press to stop Disc or videotape playback.

Arrow Buttons

Use the Arrow buttons to select or adjust menu items.

RETURN Button

Press to go to the previous Setup menu in DVD mode. Press to remove some menus or displays.

REPEAT Button

Press to play a Disc, Title, Chapter, or Track repeatedly. Details are on page 56.

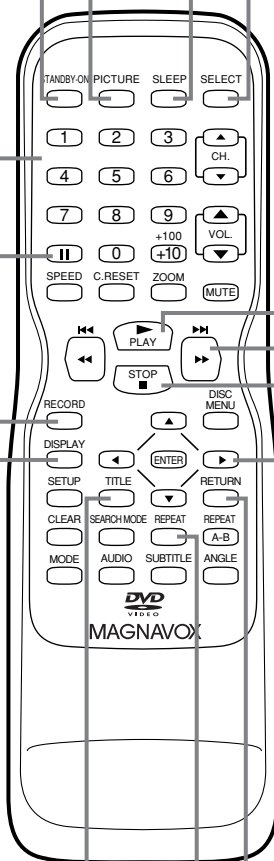

Remote Control Buttons (cont'd) 15

ZOOM Button

Press to enlarge the picture during DVD playback. *Details are on page 59.*

C.RESET (counter reset) Button

Press to reset the tape counter to 0:00:00. *Details are on page 36.*
Press to cancel a timer recording. *Details are on page 31.*

SPEED Button

Press to choose a tape recording speed (SP or SLP). *Details are on page 26.*

⏮ / ⏪ Button

During Disc play, press briefly to skip to the beginning of the current Track/Chapter. Press repeatedly to skip to previous Tracks/Chapters. *Details are on page 54.*
Or, press and hold for two seconds to search backward during Disc playback. *Details are on page 52.*
Press to reverse a videotape. *Details are on page 39.*

SETUP Button

Press to access or remove the TV/VCR/DVD's Setup menu.

CLEAR Button

Press to reset or erase a setting or wrong information.

MODE Button

Press to play a Program or to start Random playback. *Details are on page 65.*
Press to select a Black Level or Virtual Surround setting. *Details are on page 74.*

SEARCH MODE Button

Press to find a specific time, Chapter, Track, or Title on a Disc. *Details are on pages 53-54.*
Press to set up Markers. *Details are on page 57.*

CH. (channel) ▲/▼ Buttons

Press to select memorized TV channels. *Details are on page 11.*

VOL. (volume) ▲/▼ Buttons

Press to adjust the volume.

MUTE Button

Press to mute or restore the sound.

DISC MENU Button

Press to access DVD Disc menus. *Details are on page 51.*

ENTER Button

Press to accept or change a menu setting.

REPEAT A-B Button

Press to set a section of a Disc to play repeatedly. *Details are on page 56.*

ANGLE Button

Press to change the camera angle and watch a Disc sequence from a different perspective. *Details are on page 58.*

SUBTITLE Button

Press to select a subtitle language. *Details are on page 58.*

AUDIO Button

Press to select an audio language or sound mode. *Details are on page 64.*

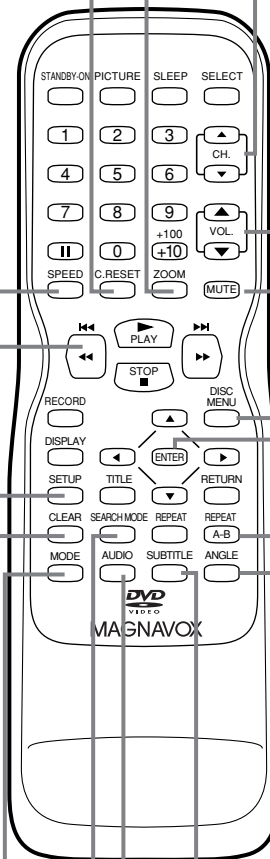

16 Front Panel

Cassette Compartment

Insert a videotape here.

Disc tray

Insert a Disc here.

CHANNEL ▲/▼ Buttons

Press to select TV channels.

Details are on page 11.

OPEN/CLOSE ▲ Button (DVD)

Press to open or close the disc tray.

Details are on page 13.

STOP ■ Button (DVD)

Press to stop Disc playback.

Details are on page 13.

VOLUME ▲/▼ Buttons

Press to adjust the volume.

STANDBY-ON Button

Press to turn the TV/VCR/DVD on or off. Turn off the TV/VCR/DVD for a timer recording.

PLAY ► Button (DVD)

Press to start Disc playback.

Details are on page 13.

PREV ◀◀,

NEXT ▶▶▶ Buttons (DVD)

Press to go to a different Chapter or Track. Details are on page 54.

DVD light (green)

Appears if the TV/VCR/DVD is in DVD mode.

OUTPUT Button

Press to select AUX, TV/VCR, or DVD mode. If you switch to TV/VCR mode, wait about four seconds before switching back to DVD mode. This button works the same as the SELECT button on the remote.

VCR/TV light (red)

Appears if the TV/VCR/DVD is in TV/VCR mode.

REC/OTR light (red)

This light flashes during recording. It lights when the TV/VCR/DVD is in Standby mode (power off) for a timer recording.

REC/OTR Button (VCR)

Press to start a videotape recording.

Details are on pages 26-27.

REW ◀◀ Button (VCR)

Press to rewind the tape or to search backward quickly during playback.

Details are on page 39.

STOP/EJECT ■▲

Button (VCR)

Press to stop tape playback. Press while play is stopped to remove the tape.

F.FWD ▶▶▶ Button

(VCR)

Press to fast forward the tape or to search forward quickly during playback.

Details are on page 39.

PLAY ► Button (VCR)

Press to start tape playback.

Details are on page 12.

VIDEO and AUDIO L/R

(left/right) In jacks Use audio and video cables to connect these jacks to the Audio and Video Out jacks of a Camcorder, DVD Player, or VCR. This lets you watch materials playing on the other equipment when you choose AUX at the TV/VCR/DVD. Details are on pages nine and 33.

HEADPHONE jack

Connect headphones (not supplied) here for personal listening.

Remote Sensor

Receives a signal from your remote control so you can operate the TV/VCR/DVD from a distance.

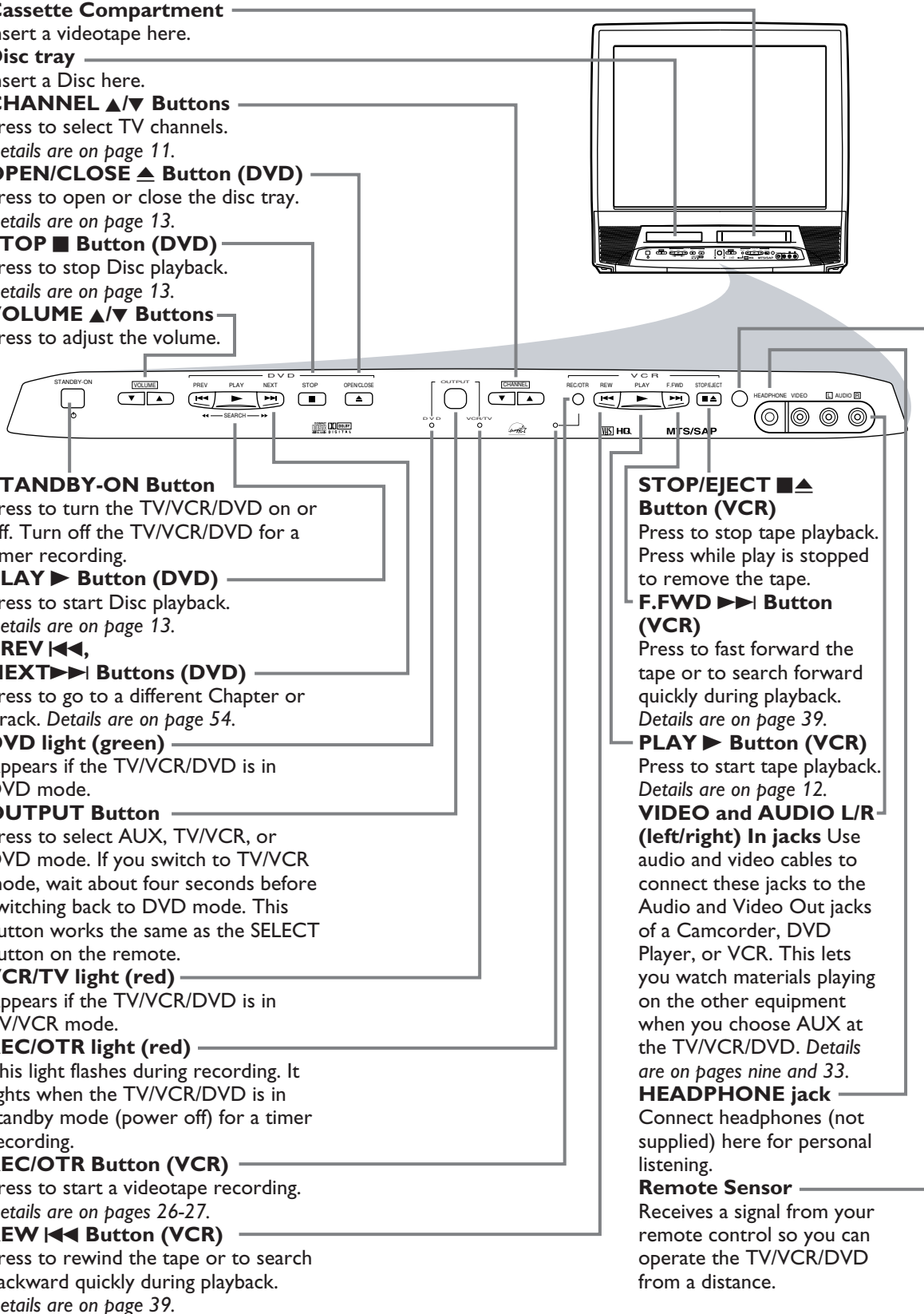

Rear Panel 17

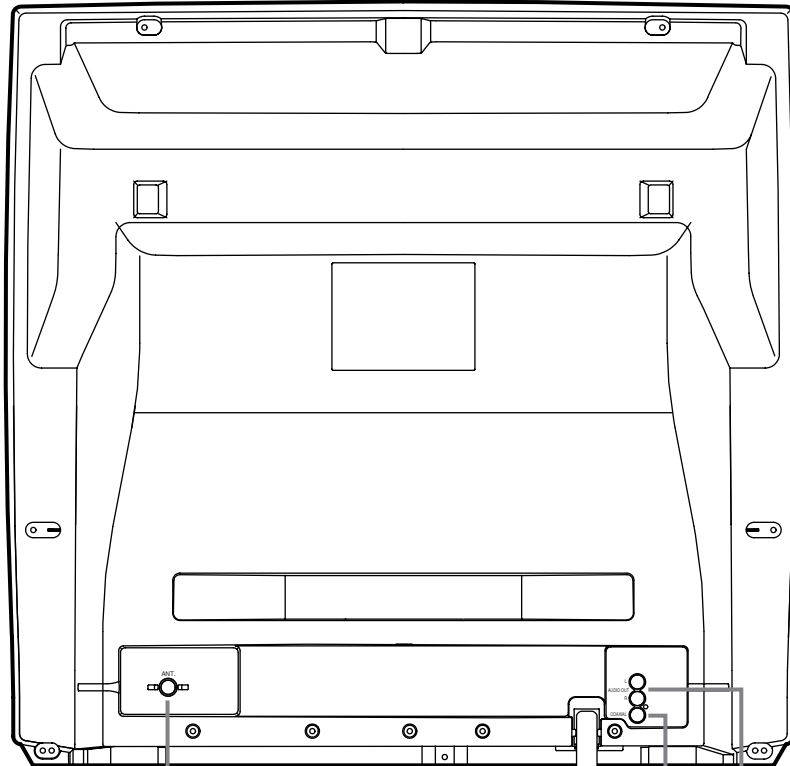

ANT. Jack
(Antenna In)

Connect an antenna or Cable TV signal here. This brings TV channels to the TV/VCR/DVD. If you do not connect an antenna or Cable TV signal to the TV/VCR/DVD (or connect to a Cable Box/Satellite Receiver through this jack), you will not receive any TV channels. *Details are on pages eight-nine.*

Power Cord

Connect to a standard AC outlet (120V/60Hz).

COAXIAL Jack
(Digital Audio Out) (orange)

Connect this jack to a Digital Stereo using a digital audio coaxial cable (not supplied). Use this connection if the Stereo has Dolby Digital compatibility and has a Digital Coaxial Audio In jack. You may also use this connection when connecting the TV/VCR/DVD to a Mini-Disc or Digital Audio Tape deck. *Details are on page 10.*

AUDIO OUT L/R jacks
(Audio Out, left and right, white and red)

Connect these jacks to an analog Stereo. The Stereo will have right and left Audio In jacks. This means it receives and sends sound through two channels, the right and the left. These jacks are usually red and white on the Stereo.

Details are on page 10.

18 Menu Language, Resetting TV Channels

Menu Language

This affects the language of the TV/VCR/DVD's setup menus and on-screen display terms. It does not alter the language of TV programming, videotapes, Discs, or closed captioning.

1 Press **SETUP** once so the **TV/VCR SETUP** menu appears.

2 Press **▲** or **▼** to select **LANGUAGE**.

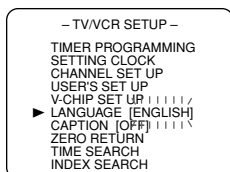

3 Press **ENTER** repeatedly to select **ENGLISH**, **ESPAÑOL**, or **FRANCAIS**. The selected language will appear inside the [].

This will be the language of the TV/VCR/DVD setup menus in both TV/VCR and DVD modes.

4 Press **SETUP** to exit the menu.

Resetting TV Channels

The TV/VCR/DVD may memorize channels when you turn it on the first time. You may reset channels with these steps.

- Before you begin, put the TV/VCR/DVD in TV/VCR mode. Press **SELECT** so the red VCR/TV light appears on the front of the TV/VCR/DVD.

1 Press **SETUP**.

2 Press **▲** or **▼** to select **CHANNEL SET UP**. Then, press **ENTER**.

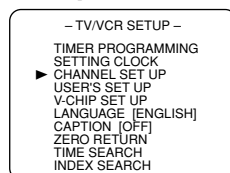

3 Press **▲** or **▼** to select **AUTO PRESET**. Press **ENTER**. The TV/VCR/DVD memorizes available channels. When scanning is complete, the TV/VCR/DVD will go to the lowest available channel. Use the **CH ▲/▼** buttons to scan memorized channels. You can select non-memorized channels with the Number buttons.

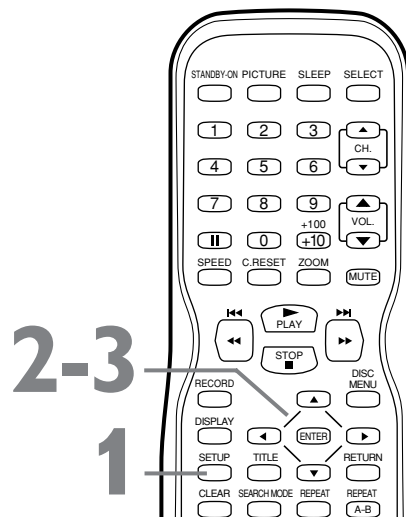
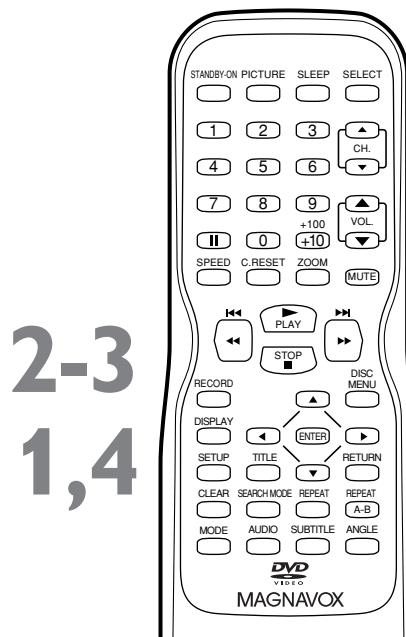
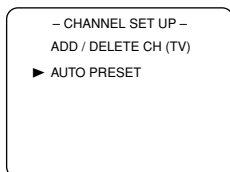

Helpful Hints

- The TV/VCR/DVD cannot change channels at the Cable Box or Satellite Receiver. Set the TV/VCR/DVD to 3, 4, or AUX. Change channels at the Cable Box/Satellite Receiver.
- If the power fails, you may have to reset the TV channels.
- If you select Spanish or French and need English, press **SETUP**. Press **▲** or **▼** to select **IDIOMA** or **LANGAGE**. Press **ENTER** to select **ENGLISH**. Press **SETUP** to remove the menu.
- You cannot reset TV channels when the unit is in DVD mode.

Adding/Deleting Channels 19

You can delete TV channels you no longer receive or seldom watch. Or, you can add more channels if the TV/VCR/DVD did not memorize all your favorite channels.

- **Before you begin, press SELECT to put the TV/VCR/DVD in TV/VCR mode. The red VCR/TV light will appear.**

1 Press **SETUP**.

2 Press **▲** or **▼** to select **CHANNEL SET UP**. Then, press **ENTER**.

```

- TV/VCR SETUP -
TIMER PROGRAMMING
SETTING CLOCK
▶ CHANNEL SET UP
USER'S SET UP
V-CHIP SET UP
LANGUAGE [ENGLISH]
CAPTION [OFF]
ZERO RETURN
TIME SEARCH
INDEX SEARCH
  
```

3 Press **▲** or **▼** to select **ADD/DELETE CH.** (TV) or (CATV) will appear beside ADD/DELETE CH. This indicates whether you connected an Antenna (TV) or a Cable TV signal (CATV) to the TV/VCR/DVD. Then, press **ENTER**. The menu will disappear and a TV channel will appear. The channel number will appear, along with ADD/DELETE.

```

- CHANNEL SET UP -
▶ ADD / DELETE CH (TV)
AUTO PRESET
  
```

4 Press **▲** or **▼** until the channel you wish to add or delete appears. You also can use the Number buttons or the CH. **▲/▼** buttons to choose a channel.

```

08
ADD / DELETE
  
```

5 Press **ENTER** to add or delete the channel. To add a channel, press **ENTER** so **ADD** and the channel number appear in light blue (teal). To delete a channel, press **ENTER** so **DELETE** and the channel number appear in light red (purple). To delete another channel, repeat steps 4-5.

6 Press **SETUP** when you are finished.

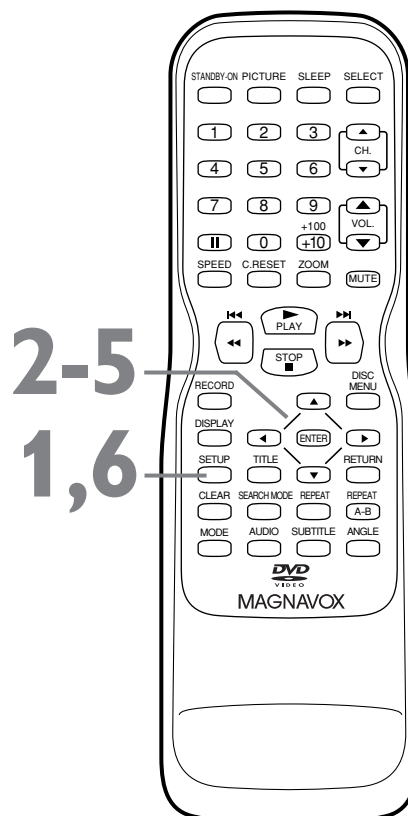

Helpful Hints

- To confirm that a channel has been added or deleted, press the CH. **▲/▼** buttons to see if you can or cannot select the channel. Only memorized/added channels can be selected with CH. **▲/▼**. Use the Number buttons to select deleted channels.
- If you connected an Antenna to the TV/VCR/DVD, channels 2-69 will be available to add or delete. If you connected to Cable TV, channels 1-125 will be available.
- This function will not operate when the unit is in DVD mode.

20 Setting the Clock

Manual Clock Setting

You must set the clock before you can do a timer recording. Set the clock manually. Afterward, use Auto Clock to monitor the time. *Details are on pages 22-23.*

If you do not receive a PBS station that carries time signals, you cannot use Auto Clock. Set AUTO CLOCK to OFF. The time will remain as you set it manually.

Before you begin ...

- With the power on, press **SELECT** to put the TV/VCR/DVD in TV/VCR mode. The red VCR/TV light will appear.

1 Press **SETUP**.

2 Press **▲** or **▼** to select **SETTING CLOCK**. Then, press **ENTER**.

```

- TV/VCR SETUP -
TIMER PROGRAMMING
SETTING CLOCK
▶ CHANNEL SET UP
USER'S SET UP
V-CHIP SET UP
LANGUAGE [ENGLISH]
CAPTION [OFF]
ZERO RETURN
TIME SEARCH
INDEX SEARCH
  
```

3 Press **▲** or **▼** to select **MANUAL CLOCK SET**. Then, press **ENTER**.

```

- SETTING CLOCK -
AUTO CLOCK [ON]
AUTO CLOCK CH SEARCH
AUTO CLOCK CH [02]
▶ MANUAL CLOCK SET
D.S.T. [OFF]
  
```

4 While the **MONTH** space is flashing, press **▲** or **▼** until the correct month appears. Then, press **▶**.

```

- MANUAL CLOCK SET -
MONTH DAY YEAR
05 . . . . .
HOUR MINUTE
. . : . . . .
  
```

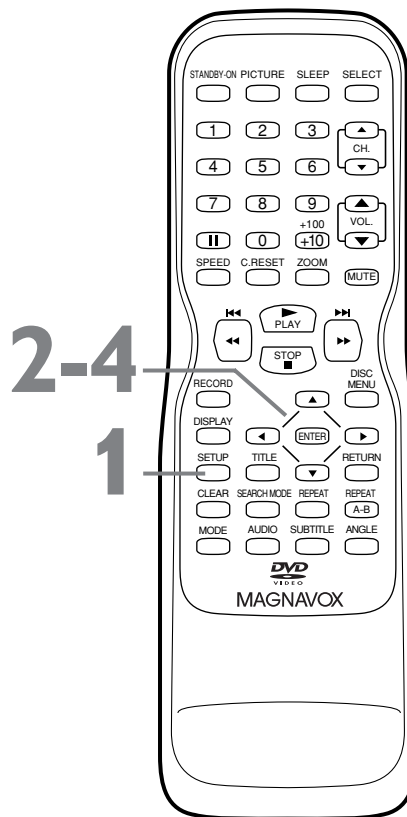

Helpful Hint

- You may have to reset the clock after a power failure.

Setting the Clock (cont'd) 21

- 5** While the **DAY** space is flashing, press ▲ or ▼ until the correct day appears. Then, press ►. An abbreviation for the selected day of the week will appear.

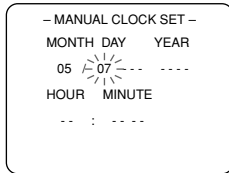

- 6** While the **YEAR** space is flashing, press ▲ or ▼ until the correct year appears. Then, press ►.

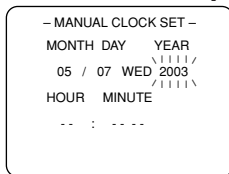

- 7** While the **HOUR** space and **AM** or **PM** are flashing, press ▲ or ▼ until the correct hour appears. Then, press ►.

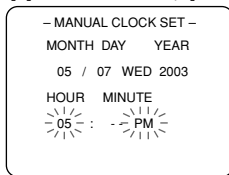

- 8** While the **MINUTE** space is flashing, press ▲ or ▼ until the correct minute appears.

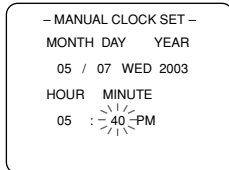

- 9** Press **SETUP**. Although seconds are not displayed, they begin counting from zero when you press SETUP. Use this action to synchronize the clock exactly.

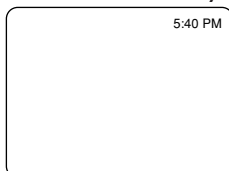

Press DISPLAY to see the current time on the screen. Details are on page 25.

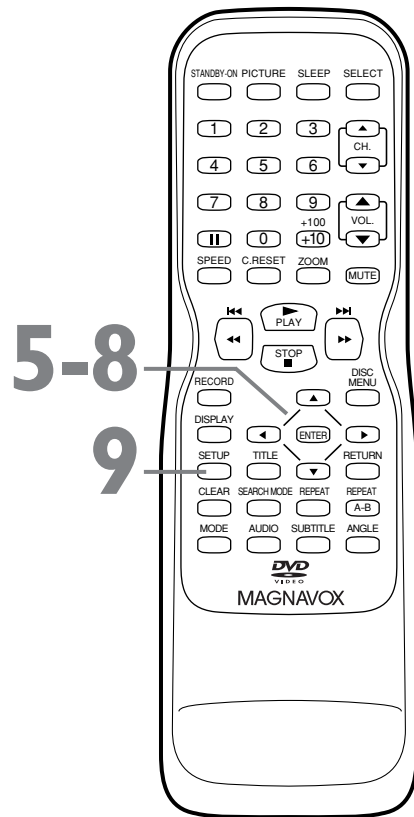

Helpful Hint

- To adjust the clock later, follow steps 1-3 on page 20. Then press ◀ or ▶ to select the item you want to change. Enter the correct information by pressing ▲ or ▼. Press SETUP when you are finished.

22 Setting the Clock (cont'd)

Auto Clock Setting

You can have the TV/VCR/DVD adjust the clock using your PBS channel. Once you set the clock manually, the TV/VCR/DVD will monitor the correct time and date broadcast by the PBS station.

Before you begin ...

- Turn on the TV/VCR/DVD power.
- Connect the antenna/Cable TV signal.
Details are on pages eight-nine.
- Turn on the Cable Box/Satellite Receiver (if applicable).
- Set up the TV channels. *Details are on pages 18-19.*
- Set the clock manually. *Details are on pages 20-21.*
- Press **SELECT** to put the TV/VCR/DVD in TV/VCR mode. The red VCR/TV light will appear.

1 Press **SETUP**.

2 Press **▲** or **▼** to select **SETTING CLOCK**. Press **ENTER**.

```

- TV/VCR SETUP -
TIMER PROGRAMMING
▶ SETTING CLOCK
CHANNEL SET UP
USER'S SET UP
V-CHIP SET UP
LANGUAGE [ENGLISH]
CAPTION [OFF]
ZERO RETURN
TIME SEARCH
INDEX SEARCH
  
```

3 With **AUTO CLOCK** selected, press **ENTER** so **ON** appears beside **AUTO CLOCK**.

```

- SETTING CLOCK -
▶ AUTO CLOCK [ON]
AUTO CLOCK CH SEARCH
AUTO CLOCK CH [02]
MANUAL CLOCK SET
D.S.T. [OFF]
  
```

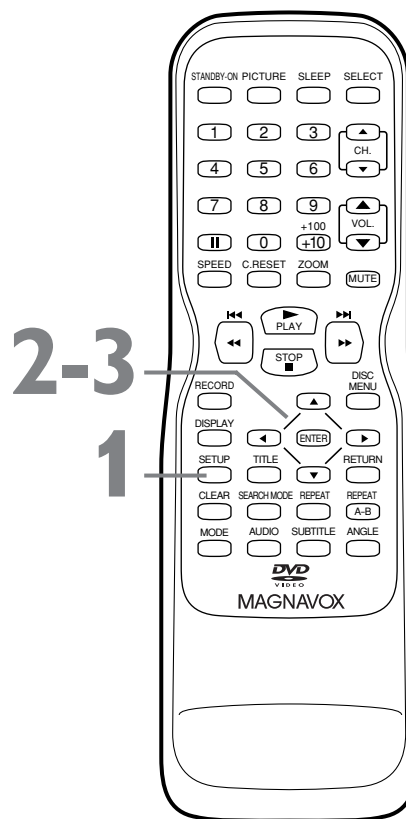

Helpful Hint

- If the TV/VCR/DVD is connected to a Cable Box or Satellite Receiver, select the local PBS station on the Cable Box/Satellite Receiver. Set the TV/VCR/DVD to the output channel of the Cable Box/Satellite Receiver (03, 04, or AUX).

Setting the Clock (cont'd) 23

- 4** If you already know your PBS channel number, skip ahead to step 8. If you do not know the channel number of your PBS station, press **▼** to select **AUTO CLOCK CH SEARCH**. Then press **ENTER**.

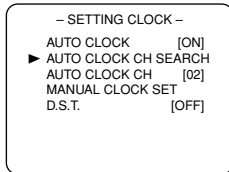

- The TV/DVD/VCR will search for a channel that carries a time signal. Channels that carry the time will appear at the top of the screen. Use one of these channels when you enter your **AUTO CLOCK CH** at step 9. This may take several minutes. An “_ _ _” appears in the lower left corner of the screen when the search is complete.

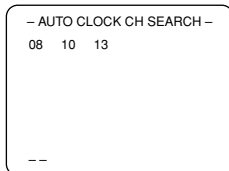

- 5** Press **SETUP** to remove the **AUTO CLOCK CH SEARCH** screen.
- 6** Press **SETUP** to access the menu again.
- 7** Press **▲** or **▼** to select **SETTING CLOCK**. Then, press **ENTER**.
- 8** Press **▼** to select **AUTO CLOCK CH**, then press **ENTER**.

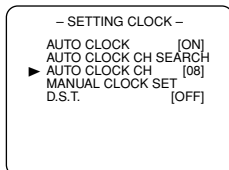

- 9** Press **◀** or **▶** until the channel number of your PBS station appears. Use the channel number you found at step 4.
- 10** Press **SETUP** to remove the menu.
- 11** Press **STANDBY-ON** to turn off the TV/VCR/DVD and let the PBS channel update the clock.

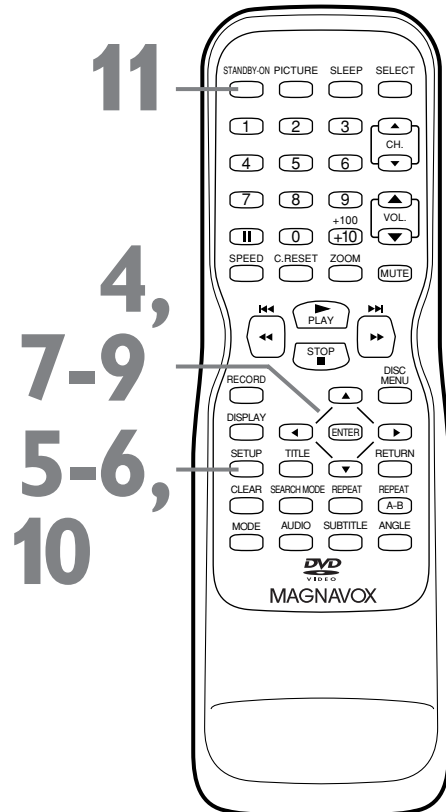

Helpful Hints

- During the Auto Clock Channel Search, the picture may be distorted. This is normal.
- If there are no PBS stations available, set **AUTO CLOCK** to off. Set the clock manually.

24 Daylight-Savings Time

When Daylight-Savings Time (D.S.T.) is ON, the clock will move forward one hour on the first Sunday in April and move back one hour on the last Sunday in October. To turn Daylight-Savings Time ON or OFF, follow the steps below.

- Before you begin, press **SELECT** to put the **TV/VCR/DVD** in **TV/VCR** mode. The red **VCR/TV** light will appear.

1 Press **SETUP**.

2 Press **▲** or **▼** to select **SETTING CLOCK**. Then, press **ENTER**.

```

- TV/VCR SETUP -
▶ TIMER PROGRAMMING
▶ SETTING CLOCK
  CHANNEL SET UP
  USER'S SET UP
  V-CHIP SET UP
  LANGUAGE [ENGLISH]
  CAPTION [OFF]
  ZERO RETURN
  TIME SEARCH
  INDEX SEARCH
  
```

3 Press **▲** or **▼** to select **D.S.T.** Then, press **ENTER** until **ON** appears beside **D.S.T.** Or, press **ENTER** so **OFF** appears beside **D.S.T.** if you want to disable this feature.

```

- SETTING CLOCK -
  AUTO CLOCK [ON]
  AUTO CLOCK CH SEARCH
  AUTO CLOCK CH [02]
  MANUAL CLOCK SET
  ▶ D.S.T. [ON]
  
```

4 Press **SETUP** to remove the menu.

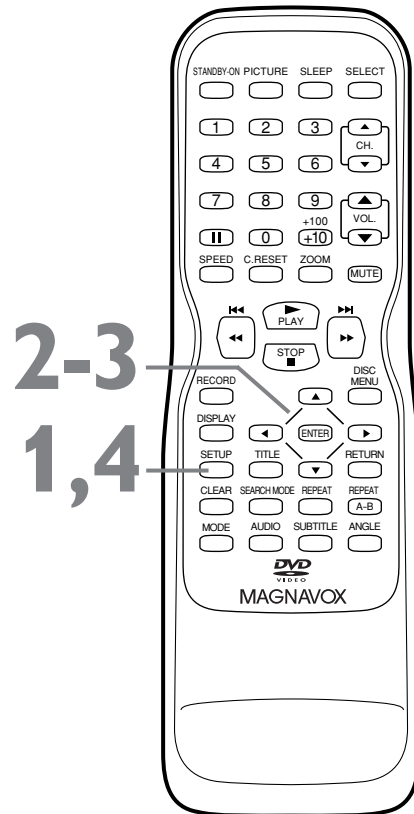

Status Displays, Picture Controls 25

Status Displays

To see the Videotape Counter, Clock, or Channel number on the screen in TV/VCR mode, press DISPLAY repeatedly. The following will occur when Closed Captions are OFF.

- 1 Press **DISPLAY** once to see the **Videotape counter**. After five seconds, only the counter will remain on the screen.

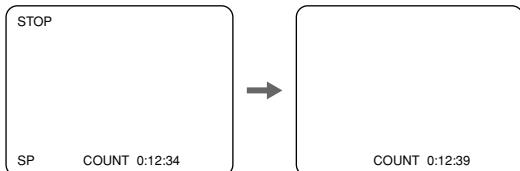

- 2 Press **DISPLAY** again to see the **current time and TV channel**. After five seconds, only the clock and channel number will remain on the screen. To clear them, press **DISPLAY** again.

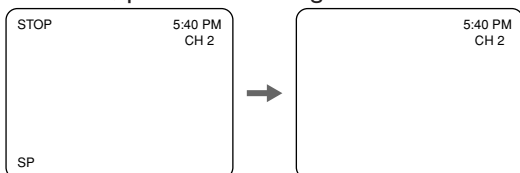

- When Closed Captions are ON, the status displays will appear for only five seconds. Then all the information will clear from the screen. *Closed Caption details are on page 41.*

Picture Controls

Follow these steps to adjust the TV/VCR/DVD's brightness, sharpness, tint, color, or contrast.

- 1 Press **PICTURE**.
- 2 Within five seconds, press **▲** or **▼** to select the picture control you want to adjust. You can select **BRIGHT**, **SHARPNESS**, **TINT**, **COLOR**, or **CONTRAST**.

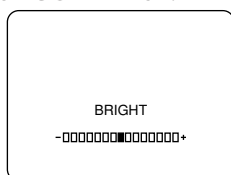

- 3 Within five seconds, press **◀** or **▶** to adjust the picture control.

	◀	▶
BRIGHT	to decrease brightness	to increase brightness
SHARPNESS	to make soft	to make clear
TINT	to add purple	to add green
COLOR	to decrease color	to brighten color
CONTRAST	to decrease contrast	to increase contrast

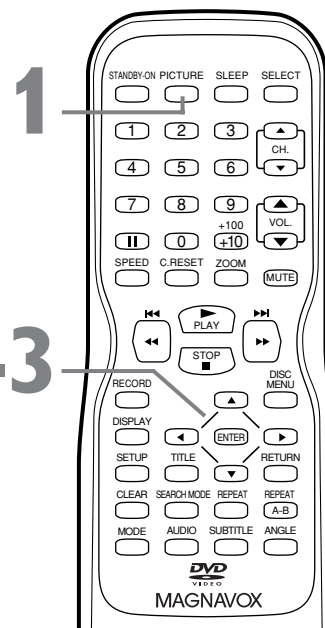
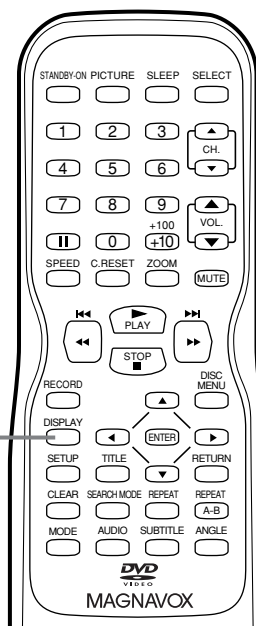

Helpful Hint

- **Degaussing:** Magnetism from nearby appliances and speakers might affect the color of the TV picture. If this happens, move the TV/VCR/DVD away from the appliance. If the color is still not correct, turn off the power for 30 minutes (for 27MDTR20) or disconnect the power cord for 30 minutes (19MDTR20). After 30 minutes, try using the unit again.

26 Videotape Recording

- 1 Place a tape with its record tab intact in the cassette compartment of the TV/VCR/DVD.**
The TV/VCR/DVD power will come on.
If the power is already on and a videotape is in the unit, make sure the unit is in TV/VCR mode.
Press SELECT so the red VCR/TV light appears on the front of the unit.
- 2 Press SPEED until the desired tape speed (SP or SLP) appears in the bottom left corner of the screen.** See *tape speed details below*.
- 3 Press CH. ▲/▼ or the Number buttons to select the channel you want to record.**
You cannot change channels during recording. You can only record and view one TV channel at a time.
- 4 Press RECORD once to start recording.**
The REC/OTR light will flash on the front of the TV/VCR/DVD. (If the tape does not have a record tab, the tape will eject. Insert another tape.)
- 5 To pause the recording, press II. To resume recording, press II again or press RECORD.**
- 6 To stop recording, press STOP ■.**

- 1** Put a videotape in the TV/VCR/DVD.

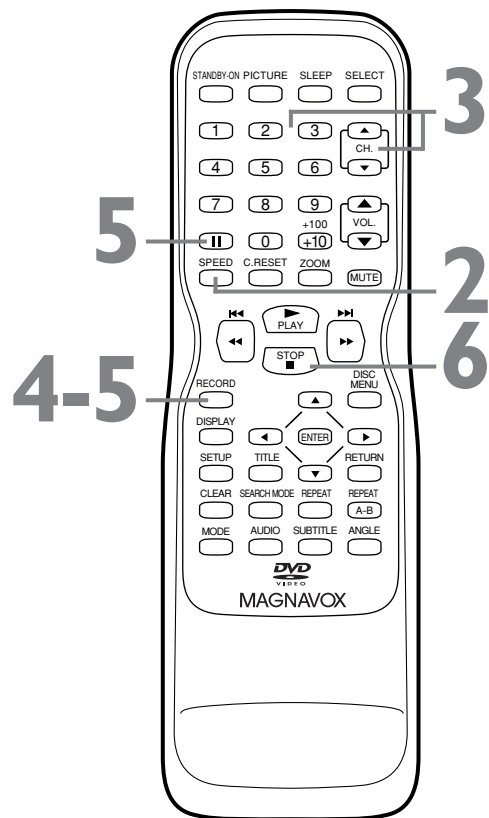

Tape Speeds

This chart shows the recording/playback time for three types of video cassettes (T160, T120, and T60). There are three playback speeds: SP, LP, and SLP. A tape will play only in the speed in which it was recorded. When recording, you can change the tape speed using the SPEED button. You cannot record in LP speed on this TV/VCR/DVD.

The slower the speed, the more programming you can fit on the tape. SLP is the slowest speed.

Tape Speed	Cassette type / Playback Time		
	T160	T120	T60
SP(Standard Play)	2 hrs. 40 mins.	2 hrs.	1 hr.
LP(Long Play) (playback only)	5 hrs. 20 mins.	4 hrs.	2 hrs.
SLP(Super Long Play)	8 hrs.	6 hrs.	3 hrs.

Helpful Hints

- You cannot record DVD contents onto a videotape using this unit.
- Recording options are on pages 27-32.
- If you pause a recording for five minutes, the unit will start Recording again automatically.
- You can change the tape speed by pressing the SPEED button while a recording is in progress. Some distortion may appear on the tape.

One-Touch Recording 27

A One-Touch Recording (OTR) is an immediate timed recording from 30 minutes to eight hours long.

Before you begin ...

- Turn on the TV/VCR/DVD.
- Press SELECT to put the unit in TV/VCR mode. The red VCR/TV light will appear on the front of the unit.
- Insert a videotape with its erase prevention tab in place. *Details are on page seven.* Rewind or fast forward the tape to the point at which you want to begin recording.

1 Press the Number buttons or CH. ▲/▼ to select the channel you want to record. Remember, if the TV/VCR/DVD is connected to a Cable Box/Satellite Receiver, the TV/VCR/DVD must be on channel 3, 4, or AUX. Select the channel you want to record at the Cable Box/Satellite Receiver. *Details are on page eight.*

2 Press SPEED to select a tape recording speed (SP or SLP). *Details are on page 26.*

3 Press REC/OTR on the front of the TV/VCR/DVD repeatedly to select a recording length. Recording will start immediately. Each press of REC/OTR will increase the recording time by 30 minutes. The maximum recording length is eight hours.

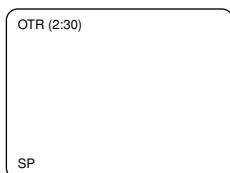

4 Press STOP ■ to stop a one-touch recording before its designated end time. Otherwise, recording will stop at the time you designated. The TV/VCR/DVD will turn off when the OTR ends.

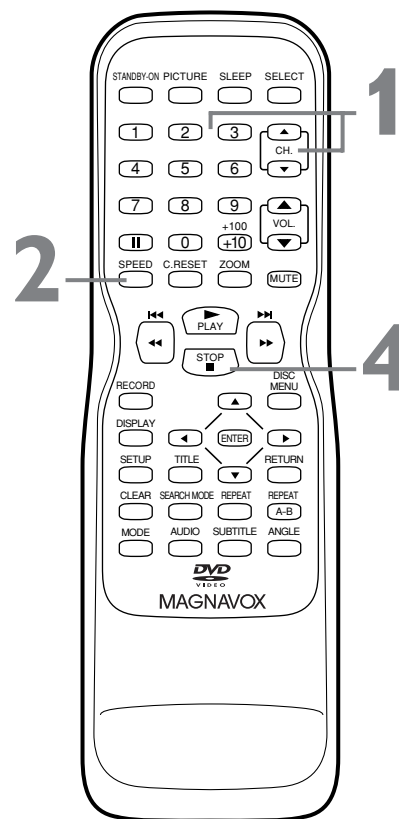

3 Press REC/OTR on the front of the TV/VCR/DVD.

Helpful Hints

- You cannot do an OTR with the remote control.
- To show the remaining recording time, press DISPLAY. OTR and the remaining recording time will appear briefly in the top left corner of the screen.
- If the tape ends before the recording's end time, the TV/VCR/DVD will stop recording, eject the tape, and turn itself off.
- An OTR will continue even if you turn off the TV/VCR/DVD. The red REC/OTR light will flash on the front of the TV/VCR/DVD to indicate recording is still in progress.

28 Timer Recording

Follow the steps below to program the TV/VCR/DVD to record TV programs while you're away from home. The TV/VCR/DVD will record and turn itself off automatically. You can set a maximum of eight timer recordings.

Before you begin, make sure ...

- The clock is set. If the clock is not set, the MANUAL CLOCK SET menu will appear. See pages 20-21 to set the clock.
- Channels are set. *Details are on page 18.*
- A tape is in the TV/VCR/DVD. Make sure the record tab is intact. *Details are on page seven.*

1 Press **SETUP**. Press **▲** or **▼** to select **TIMER PROGRAMMING**, then press **ENTER**.

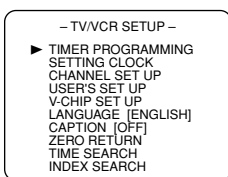

2 Press **▲** or **▼** to select a program position. Then, press **▶**.

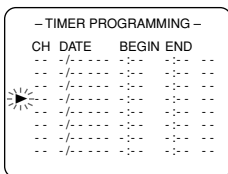

3 While **CH** is selected, press **▲** or **▼** to select the channel you want to record. Then press **▶**.

If the TV/VCR/DVD is connected to a Cable Box/Satellite Receiver, the TV/VCR/DVD must be on channel 3, 4, or AUX. Set CH as 03, 04, or AUX in the Timer Programming menu. Choose the channel you want to record at the Cable Box/Satellite Receiver. Leave the Cable Box/Satellite Receiver on for the timer recording. Leave the TV/VCR/DVD set to AUX. (Press **SELECT** on the remote to choose AUX at the TV/VCR/DVD.) *Additional details are on page eight.*

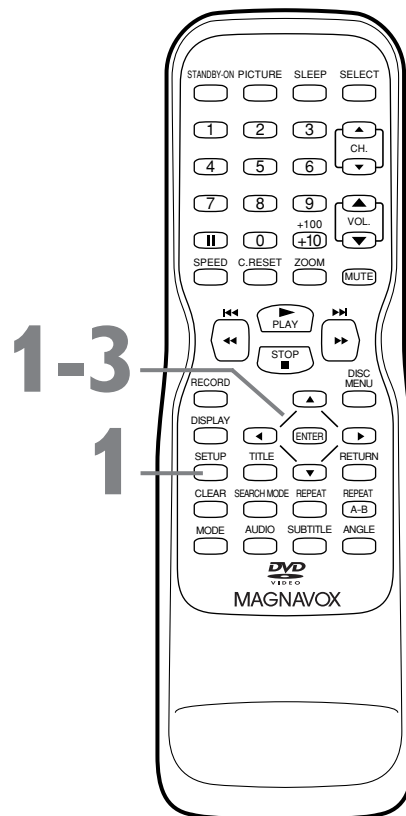
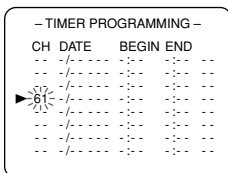

Helpful Hint

- If the tape ends before the recording is complete, the TV/VCR/DVD will stop recording immediately and eject the tape.

Timer Recording (cont'd) 29

4 While **DATE** is selected, press **▲** or **▼** until the correct **DATE** appears. Recording will happen once.

- TIMER PROGRAMMING -		
CH	DATE	BEGIN END
--	-/-	----
--	-/-	----
▶ 61	7/04 FRI	-----
--	-/-	----
--	-/-	----
--	-/-	----

Or, to record a program at the same time on the same channel every weekday (Monday-Friday), press **▼** until **EVERY DAY** appears.

- TIMER PROGRAMMING -		
CH	DATE	BEGIN END
--	-/-	----
--	-/-	----
▶ 61	EVERY DAY	-----
--	-/-	----
--	-/-	----
--	-/-	----

Or, to record a program at the same time on the same channel every week, press **▼** until **EVERY** and a day of the week appear together.

- TIMER PROGRAMMING -		
CH	DATE	BEGIN END
--	-/-	----
--	-/-	----
▶ 61	EVERY MON	-----
--	-/-	----
--	-/-	----
--	-/-	----

Finally, press **▶**.

5 While **BEGIN** is selected, press **▲** or **▼** to select the hour you want recording to begin. AM or PM will appear with the hour. Then, press **▶** and press **▲** or **▼** to select the minute you want recording to start. Press **▶**.

- TIMER PROGRAMMING -		
CH	DATE	BEGIN END
--	-/-	----
--	-/-	----
▶ 61	7/04 FRI	7:30-----
--	-/-	----
--	-/-	----
--	-/-	----

4-5

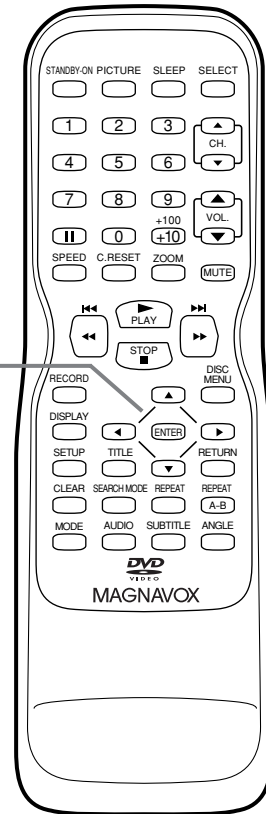

30 Timer Recording (cont'd)

- 6** While **END** is selected, press **▲** or **▼** to select the hour at which you want recording to stop. AM or PM will appear with the hour. Then, press **▶** and press **▲** or **▼** to select the minute at which you want recording to end. Press **▶**.

-TIMER PROGRAMMING-			
CH	DATE	BEGIN	END
--	-/-	----	----
--	-/-	----	----
▶ 61	7/04 FRI	7:30	8:50
--	-/-	----	----
--	-/-	----	----
--	-/-	----	----

- 7** Press **▲** or **▼** until the tape speed (**SP** or **SLP**) appears at the right end of the line.

-TIMER PROGRAMMING-			
CH	DATE	BEGIN	END
--	-/-	----	----
--	-/-	----	----
▶ 61	7/04 FRI	7:30	8:50
--	-/-	----	----
--	-/-	----	----
--	-/-	----	----

- 8** Press **SETUP** to remove the menus.

- 9** Press **STANDBY-ON** to turn off the **TV/VCR/DVD** and set the timer recording. The red **REC/OTR** light will appear on the front of the **TV/VCR/DVD**. You must turn off the **TV/VCR/DVD** to activate a timer recording. If the power is not off and you continue watching **TV**, **TIMER REC STANDBY** starts flashing on the screen two minutes before the programmed start time. Turn off the unit to do the recording.

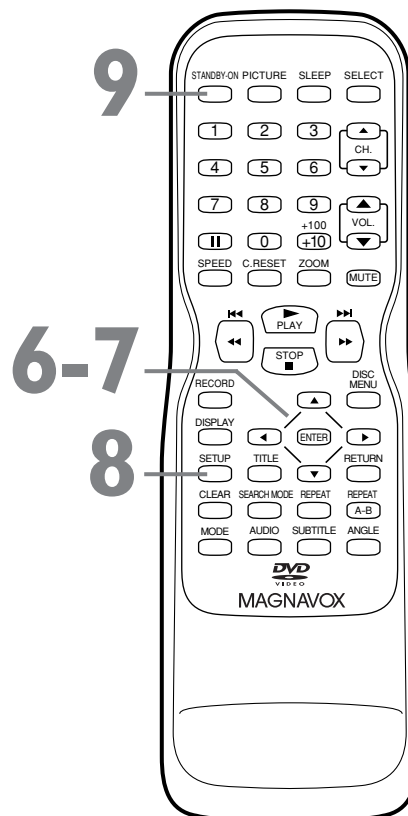

Helpful Hints

- To correct information while setting the Timer Recording, press **◀** to go back one step and select the incorrect information. Press **▲** or **▼** to enter the correct information.
- While a timer recording is in progress, the red **REC/OTR** light will flash.
- If a timer recording is set for hours or days later, you can use the **TV/VCR/DVD** until then. Just be sure to turn off the **TV/VCR/DVD** about five minutes before the recording. Set the **Cable Box/Satellite Receiver** if appropriate.
- If the record tab is missing, the videotape will eject when you press **STANDBY-ON** to turn off the **TV/VCR/DVD**. Insert a recordable tape for the timer recording.

Timer Recording (cont'd) 31

Extending a Timer Recording

To make a Timer Recording start and end later than originally scheduled, follow these steps.

- 1 With the unit on, press SETUP. Press ▲ or ▼ to select TIMER PROGRAMMING. Press ENTER.
- 2 Press RECORD, then press ▲ or ▼ to select the desired program.
- 3 Press RECORD again. Each press of RECORD will shift forward the beginning/end time by 10 minutes. If the recording is in progress, each press will shift forward the end time only.
If you adjust the times during recording, the recording speed automatically changes to SLP.
To restore the original recording times, press ■■ (pause).
- 4 Press SETUP to remove the menus.
- 5 If the timer recording is scheduled to start later, press STANDBY-ON to turn off the TV/VCR/DVD for the recording.

Correcting a Timer Recording

- 1 With the unit on, press SETUP. Press ▲ or ▼ to select TIMER PROGRAMMING. Press ENTER.
- 2 Press ▲ or ▼ to select a timer recording, then press ►.
- 3 Press ► or ◀ to select the information you want to change.
Press ▲ or ▼ to enter the correct information.
- 4 Press SETUP to remove the menu.
- 5 Press STANDBY-ON to turn off the TV/VCR/DVD to set the recording.

Cancelling Timer Recordings

To cancel a timer recording that is in progress:

- 1 The red REC/OTR light will flash during recording. Press STANDBY-ON to turn on the TV/VCR/DVD, then press STOP/EJECT ■▲ on the front of the TV/VCR/DVD.

To cancel a timer recording that has not started:

- 1 With the unit on, press SETUP.
Press ▲ or ▼ to select TIMER PROGRAMMING. Press ENTER.
- 2 Press ▲ or ▼ to select a timer recording.
- 3 Press C.RESET. All the information for the selected recording will disappear.
- 4 Press SETUP to remove the menu.

Checking Scheduled Timer Recordings

- 1 With the unit on, press SETUP.
Press ▲ or ▼ to select TIMER PROGRAMMING.
- 2 Press ENTER. The program details will appear on the screen.
- 3 Press SETUP to remove the menu.

32 Timer Recording Auto Return

Use this feature to rewind the tape to the beginning of a completed timer recording.

1 Press **SETUP**.

2 Press **▲** or **▼** to select **USER'S SET UP**. Then, press **ENTER**.

```

- TV/VCR SETUP -
TIMER PROGRAMMING
SETTING CLOCK
CHANNEL SET UP
▶ USER'S SET UP
V-CHIP SET UP
LANGUAGE [ENGLISH]
CAPTION [OFF]
ZERO RETURN
TIME SEARCH
INDEX SEARCH
  
```

3 Press **▲** or **▼** to select **AUTO RETURN**.

4 Press **ENTER** until **ON** appears beside **AUTO RETURN**. To turn off **AUTO RETURN**, press **ENTER** to choose **OFF** instead.

```

- USER'S SET UP -
RENTAL [OFF]
REPEAT PLAY [OFF]
▶ AUTO RETURN [ON]
VCR AUDIO [HI-FI]
TV AUDIO [STEREO]
  
```

5 Press **SETUP**. When **AUTO RETURN** is **ON**, when all the timer recordings are completed, the tape will rewind to the beginning of the recorded program(s).

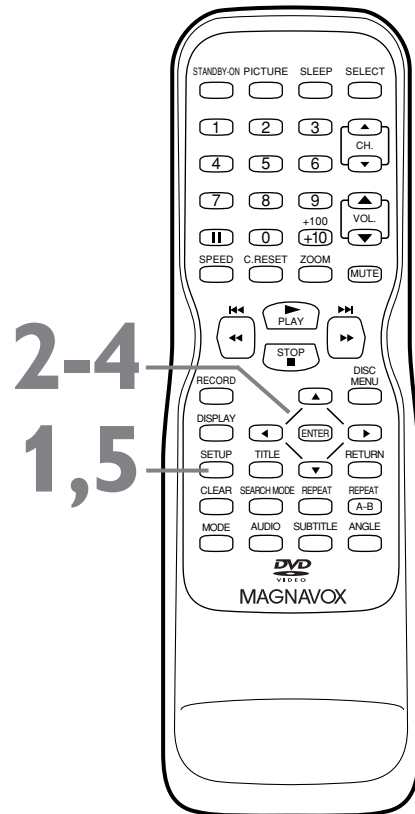

Helpful Hints

- If you press **STANDBY-ON** while the tape is rewinding, the rewinding will stop.
- If there is a power failure, the **TV/VCR/DVD** will retain its memory for this feature.

Rerecording (Tape Duplication) 33

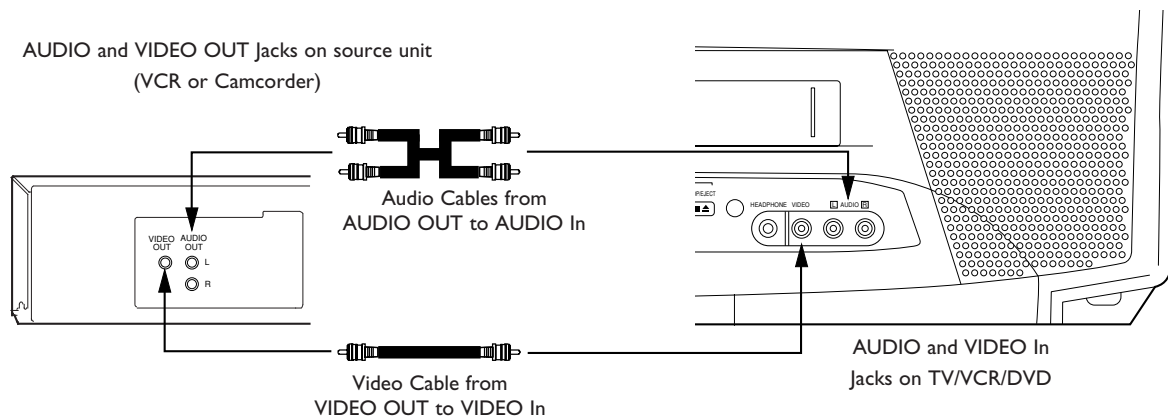

- 1** Make the connections shown above. Use audio and video cables (not supplied). Connect the source unit (VCR or Camcorder) to a power source after connections are made.
- 2** The VCR or Camcorder will play your tape. Insert a prerecorded tape in the source unit. If play begins, press STOP on the VCR or Camcorder.
- 3** The TV/VCR/DVD will record your tape. Insert a blank videotape in the cassette compartment of the TV/VCR/DVD. Make sure the tape's record tab is intact and the TV/VCR/DVD power is on.
- 4** Point the TV/VCR/DVD remote control at the TV/VCR/DVD. Press SELECT or CH. ▲/▼ until AUX appears on the screen. The TV/VCR/DVD is now in Line Input or Auxiliary mode.
- 5** Press SPEED until the desired tape speed (SP or SLP) appears in the lower left corner of the screen.
- 6** Press PLAY on the VCR or Camcorder and REC(ord)/OTR on your TV/VCR/DVD at the same time. Videotape copying will begin.
- 7** To stop copying, press STOP/EJECT ■▲ on the TV/VCR/DVD, then stop the tape on the VCR or Camcorder.

Helpful Hints

- Unauthorized recording of copyrighted television programs, videotapes, or other materials may infringe on the rights of copyright owners and violate copyright laws.
- Different brands of equipment may operate differently.
- Make sure all connections are secure. Otherwise, you may not record both picture and sound.
- Programs that are copyright protected may not record clearly.
- You cannot record a DVD onto a videotape using this TV/VCR/DVD.
- You can use this connection to simply view tapes playing on a camcorder or VCR at the TV/VCR/DVD. Follow steps 1, 2, and 4 for connections and AUX setup. Then play the tape on the camcorder, etc., as usual.

34 Repeat Play

Repeat Play allows you to play a videotape continuously. ALL REPEAT will repeatedly play the tape from the beginning to the end. BLANK REPEAT will repeatedly play the tape from its beginning to the first part that is blank for more than 10 seconds.

1 Press **SETUP**.

2 Press **▲** or **▼** to select **USER'S SET UP**. Then, press **ENTER**.

– TV/VCR SETUP –
 TIMER PROGRAMMING
 SETTING CLOCK
 CHANNEL SET UP
 ► USER'S SET UP
 V-CHIP SET UP
 LANGUAGE [ENGLISH]
 CAPTION [OFF]
 ZERO RETURN
 TIME SEARCH
 INDEX SEARCH

3 Press **▲** or **▼** to select **REPEAT PLAY**.

4 Press **ENTER** until **ALL** or **BLANK** appears beside **REPEAT PLAY**. Or, to cancel **REPEAT PLAY**, press **ENTER** to select **OFF**.

– USER'S SET UP –
 RENTAL [OFF]
 ► REPEAT PLAY [ALL]
 AUTO RETURN [OFF]
 VCR AUDIO [HIFI]
 TV AUDIO [STEREO]

5 Press **SETUP** to remove the menu.

6 Press **PLAY ►** to play a videotape. **REPEAT PLAY ►** will appear on the screen briefly.

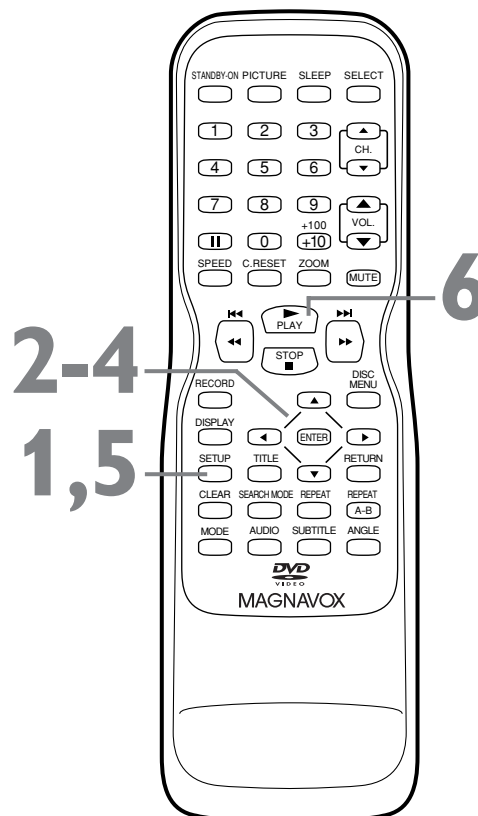

Helpful Hints

- Repeat Play stays in effect after you turn off the TV/VCR/DVD. The TV/VCR/DVD keeps the Repeat Play setting even if the power fails.
- If RENTAL is ON, RENTAL PLAY ► will appear on the screen instead of REPEAT PLAY ►. Details are on page 35.

Rental Play 35

This function enables you to improve picture quality when playing worn cassettes such as rented videotapes.

1 Press **SETUP**.

2 Press **▲** or **▼** to select **USER'S SET UP**. Then, press **ENTER**.

```

- TV/VCR SETUP -
TIMER PROGRAMMING
SETTING CLOCK
CHANNEL SET UP
▶ USER'S SET UP
V-CHIP SET UP
LANGUAGE [ENGLISH]
CAPTION [OFF]
ZERO RETURN
TIME SEARCH
INDEX SEARCH
  
```

3 Press **▲** or **▼** to select **RENTAL**. Press **ENTER** until **ON** appears beside **RENTAL**. To turn off **RENTAL**, press **ENTER** to choose **OFF**.

```

- USER'S SET UP -
▶ RENTAL [ON]
REPEAT PLAY [OFF]
AUTO RETURN [OFF]
VCR AUDIO [HIFI]
TV AUDIO [STEREO]
  
```

4 Press **SETUP** to exit the menu.

5 Press **PLAY ▶** to start videotape play. **RENTAL PLAY ▶** will appear briefly on the screen.

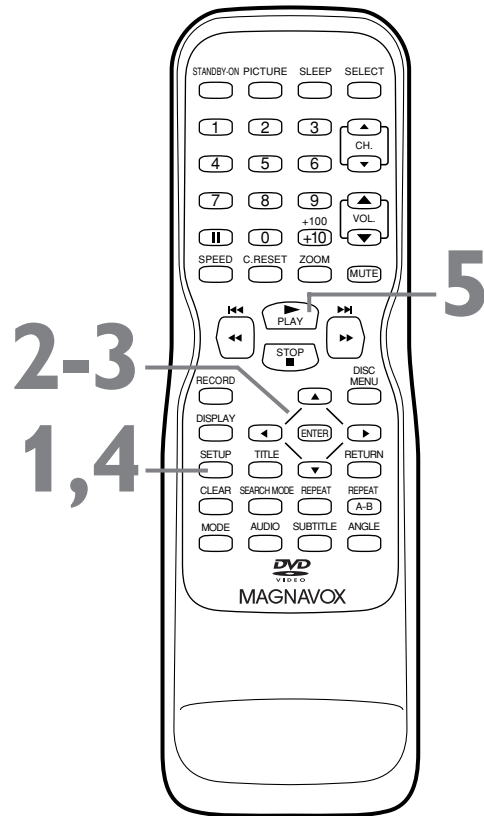

Helpful Hints

- Once you select Rental Playback, it stays in effect even after you turn off the TV/VCR/DVD.
- The TV/VCR/DVD will retain the Rental setting even if the power fails.

36 Zero Return, Sleep Timer

Zero Return

The videotape counter shows the elapsed recording or playback time in hours, minutes, and seconds from the point at which the counter was set to zero. The counter time will not change on a blank tape or blank portions on a tape. The “-” before the tape counter indicates the amount of remaining recording/playing time before the counter reaches zero. Follow the steps below to reset the tape counter to zero at a tape location you want to refer to later.

- 1** Play, rewind, or fast forward the tape to the location you would like to refer to later. Press **STOP** ■ to stop the tape.
- 2** Press **C.RESET** to set the counter to 0:00:00.
- 3** To return to this same point later, press **SETUP**. Press **▲** or **▼** to select **ZERO RETURN**. Then, press **ENTER**. The tape counter will appear on the screen. When the tape reaches the point at which you set the counter to zero, the tape will stop. Press **PLAY** ► to watch the tape from the designated point.

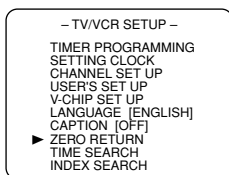

Sleep Timer

Use the Sleep Timer to program the TV/VCR/DVD to shut off in a certain amount of time.

- 1** Press **SLEEP** until the correct amount of time appears on the screen with **SLEEP**. Each press of **SLEEP** will increase the time by 30 minutes. You may set a Sleep Timer of 30, 60, 90, or 120 minutes. After five seconds, the Sleep Timer information will disappear from the screen. The TV/VCR/DVD will turn itself off after the selected amount of time has passed.

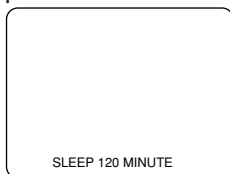

To Cancel the Sleep Timer

Press **SLEEP** until “SLEEP 0 MINUTE” appears.

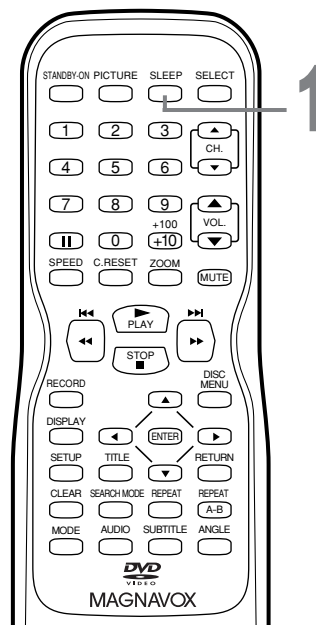
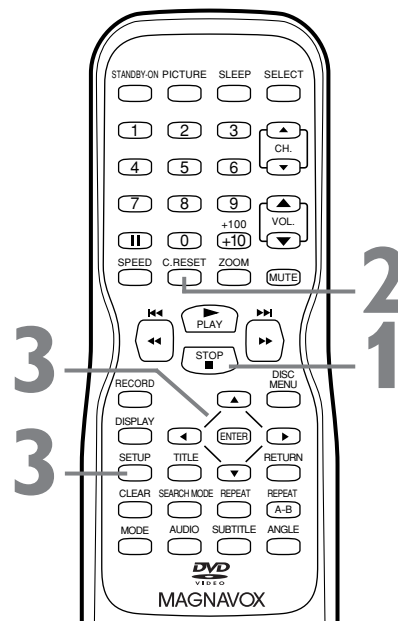

Helpful Hint

- To see how much time remains before the TV/VCR/DVD turns itself off, press **SLEEP** once. The information will disappear automatically in five seconds.

Time Search 37

Time Search lets you quickly advance the videotape to a position simply by entering the amount of playback time you want to skip.

In the example below, Time Search is set to 2 hours, 50 minutes from the present position.

1 Insert a videotape.

2 Press **SETUP**. Press **▲** or **▼** to select **TIME SEARCH**. Then, press **ENTER**.

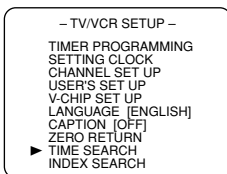

3 Press **▲** or **▼** until your desired time appears beneath **TIME SEARCH** at the top of the screen. (Example: 2:50 for 2 hours, 50 minutes) Each press of **▲** or **▼** increases or decreases the length of time by 10 minutes. To cancel the Time Search at this point, press **SETUP**.

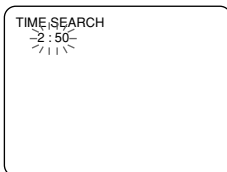

4 Press **◀** or **▶** to rewind or fast forward the tape the length of time you chose. The TV/VCR/DVD will rewind or fast forward the tape the specified amount of time. The time counts down on the screen as the search progresses. When 0:00 is reached, the tape will start playing. Or, to cancel the time search before it finishes, press **STOP**.

1 Insert a videotape.

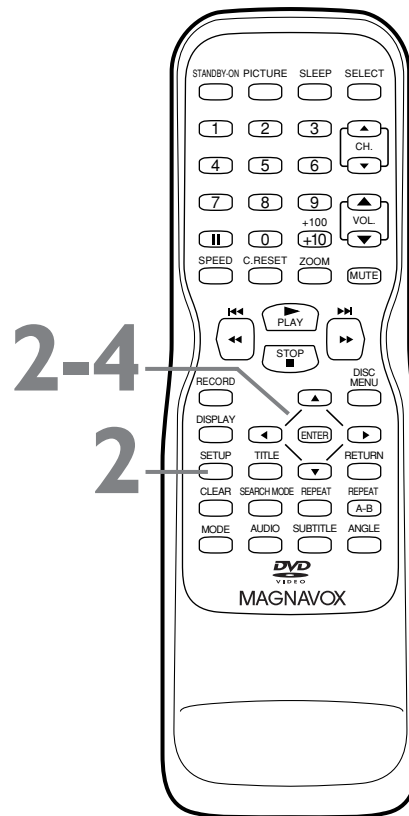

Helpful Hints

- A Time Search can be set up to a maximum of 9 hours 50 minutes in 10-minute increments.
- Time Search will not operate during recording.

38 Index Search

This feature lets you quickly rewind or fast forward to the start of recordings.

- Index Marks are made automatically at the start of all recordings. They are not made where recording pauses. The time gap between Index Marks should be greater than one minute for SP recording and three minutes for SLP recording. This means recordings should be one (SP) or three (SLP) minutes long. Otherwise, Index Search may not find the start of the recording. In some cases, Index Marks at the beginning of a videotape cannot be detected.

- 1 Press SETUP. Press ▲ or ▼ to select INDEX SEARCH. Then, press ENTER.**

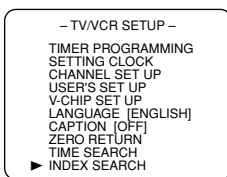

- 2 Press ▲ or ▼ until the number of programs you want to skip appears beneath INDEX SEARCH.**
 To cancel an Index Search at this point, press SETUP.

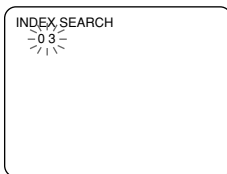

- 3 Press ◀ or ▶.** The TV/VCR/DVD begins rewinding or fast forwarding the videotape to the beginning of the desired program.

- 4** When the program is reached, play will start.

1-3
1

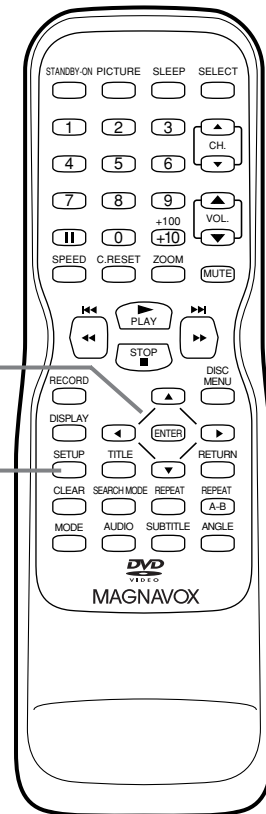

Helpful Hints

- Every time an Index Mark (or recording) is passed, the number beneath INDEX SEARCH on the screen decreases by one.
- A videotape must be in the TV/VCR/DVD for this function to work.
- You may search up to 20 Index Marks.
- This function will not operate during recording.
- To cancel an Index Search, press STOP ■.
- If the end of the tape is reached during an Index Search, the tape will rewind to the beginning. The TV/VCR/DVD will turn off and the tape will eject.

Videotape Playback Features 39

Slow Motion

1 Press **II** (pause) during play to pause the videotape. Then press **▶▶|** / **▶▶** to start slow motion. Sound will be mute during slow motion. Slow motion will stop automatically after five minutes to prevent damage to the tape.

2 Press **PLAY ▶** to return to normal playback.

Forward and Reverse Searching (SP/LP/SLP)

1 During videotape play, press and release **▶▶|** / **▶▶** or **|◀◀** / **◀◀**. A fast forward or reverse picture search will begin.

2 To return to normal play, press **PLAY ▶**.

Super High Speed Searching (LP/SLP)

1 During tape play, press **▶▶|** / **▶▶** or **|◀◀** / **◀◀**, then press again. The TV/VCR/DVD will search the tape in high speed. Press **▶▶|** / **▶▶** or **|◀◀** / **◀◀** repeatedly to switch between regular and high speed searching.

2 To return to normal play, press **PLAY ▶**.

Viewing a Still Picture

1 During tape play, press **II** (pause). A still picture will appear on the screen. The picture advances each time you press **II** (pause). After a tape is paused for five minutes, play will stop automatically. This prevents damage to the tape and TV/VCR/DVD.

2 If the still picture vibrates vertically, stabilize the picture by pressing **CH. ▲** or **▼**.

3 To release the still picture and return to normal play, press **PLAY ▶**.

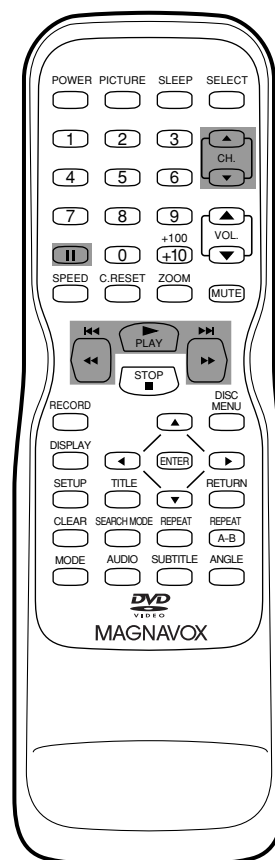

Helpful Hints

- SP/LP/SLP means this feature will work with tapes recorded in Standard Play, Long Play, or Super Long Play. LP/SLP means this feature will work with tapes recorded in Long Play and Super Long Play. Tape speed details are on page 26.
- During forward and reverse searching, horizontal noise bars will appear on the screen.

40 Automatic Operation Features

The following videotape features are available.

Automatic Rewind, Eject, Off

When you play, fast forward, or record a videotape to its end, the TV/VCR/DVD will rewind the tape, stop, turn itself off, and eject the tape.

If REPEAT PLAY is activated, play will start again instead.

Details are on page 34.

The tape will not rewind automatically after a timer recording or One-Touch Recording ends. To rewind a tape after timer recordings, see Auto Return details on page 32.

Automatic Tracking Adjustment

The TV/VCR/DVD automatically adjusts the videotape tracking to give you the best possible picture quality. With some recordings, however, you may get a better picture using the manual tracking controls (see below).

Manual Tracking

To adjust the tracking manually, press the CHANNEL ▲/▼ buttons on the front of the TV/VCR/DVD or the CH. ▲/▼ buttons on the remote control during playback.

Tracking returns to Automatic Tracking Adjustment when you insert a tape or press STOP ■.

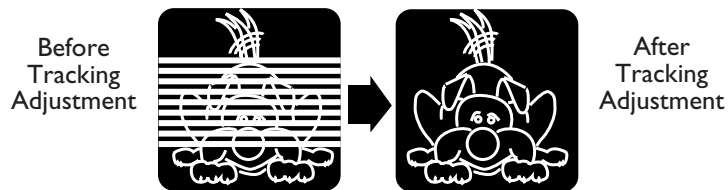

Closed Captions 41

Follow the steps below to select closed captions for TV programming. Not all TV programs and commercials have closed captions or all types of closed captions (second language, half-screen text, etc.). If closed captioning is not broadcast, you cannot receive it. This does not indicate a problem with the TV/VCR/DVD. Check your TV program listings for shows with closed captions.

If the TV/VCR/DVD receives poor quality television signals, the captions may contain errors, or there might be no captions at all. Some possible causes of poor quality signals are:

- Automobile ignition noise
- Electric motor noise
- Weak signal reception
- Multiplex signal reception (ghosts or screen flutter)
- Playing poorly recorded or worn videotapes.

- 1 Press SETUP.**
Press ▲ or ▼ to select CAPTION.

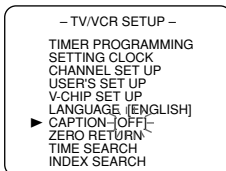

- 2 Press ENTER repeatedly to select CAPTION1, CAPTION2, TEXT1, TEXT2, or OFF.**

CAPTION1 displays standard closed captions (what a character is saying). CAPTION2 displays foreign language closed captions (foreign language words showing what a character is saying).

TEXT1 and TEXT2 display half-screen text (such as a channel guide, schedule, or announcement).

OFF turns off closed captions. Captions will not appear on the screen.

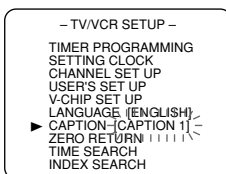

- 3 Press SETUP to exit the menu.**

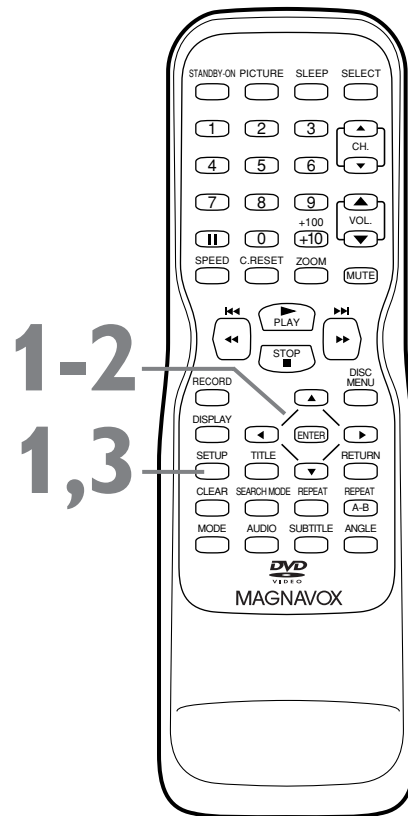

Helpful Hints

- If a black box appears on the screen, a TEXT mode is selected. Select CAPTION1, CAPTION2, or OFF.
- The TV/VCR/DVD retains the Closed Caption setting if the power fails.
- Abbreviations, symbols, and other grammatical shortcuts may be used in order to keep pace with the on-screen action. This is not a problem with the TV/VCR/DVD.
- Changing channels may delay closed captions for a few seconds.
- Adjusting or muting the volume may delay closed captions for a few seconds.

42 Setting V-Chip

TV Rating Settings

V-CHIP enables parents to prevent their children from watching inappropriate material on TV. V-CHIP reads the ratings for programming (except for news and sports programs, unedited movies on premium cable channels, and Emergency Broadcast System signals), then denies access to programming if the program's rating meets the limitations you select. In this case, a "PROTECTED PROGRAM by ..." message appears on the TV screen.

If the "PROTECTED..." message appears during your TV viewing, change to a channel that is not blocked. Then, you can access the V-CHIP SETUP menu and change the settings to allow all TV viewing.

Programming may be rated by the Motion Picture Association of America (MPAA) or according to the Television Parental Guidelines. To block any inappropriate programming, set your limits in both MPAA RATING and TV RATING.

Before you begin, make sure ...

- The TV/VCR/DVD is on.
- The unit is in TV/VCR mode. Press SELECT on the remote until you see TV channels and see the red VCR/TV light on the front of the TV/VCR/DVD.

1 Press SETUP. Press ▲ or ▼ to select V-CHIP SET UP. Then, press ENTER.

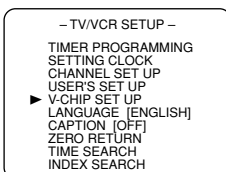

2 Press the Number buttons to enter the four-digit access code. When entering the access code for the first time or if there has been a power failure, enter default code 0000. Four Xs will appear instead of your code. This protects the identity of your code.

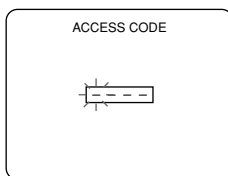

3 Press ▲ or ▼ to select TV RATING. Then, press ENTER.

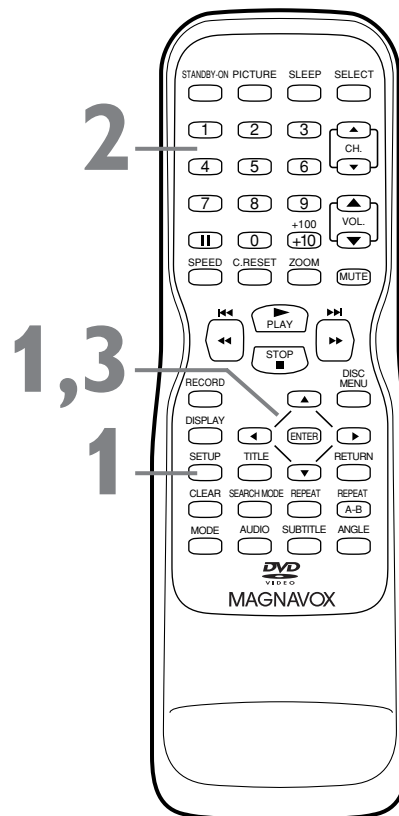
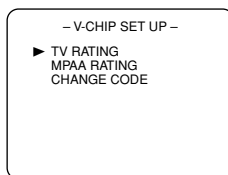

TV Rating Explanations

- TV-Y - Appropriate for all children
- TV-Y7 - Appropriate for children seven and older
- TV-G - General Audience
- TV-PG - Parental Guidance suggested.
- TV-14 - Unsuitable for children under 14
- TV-MA - Mature audience only

Setting V-Chip (cont'd) 43

- 4** Press ▲ or ▼ to select the TV Rating level at which you want to block viewing, then press **ENTER** once. If you press ENTER again, the subratings for that category will appear.

Details are on pages 44-45.

When you select the rating category and set it to **BLOCK**, the higher ratings will turn to **BLOCK** automatically. Lower ratings will turn to **VIEW**.

When you set "TV-Y" to **VIEW** (or **BLOCK**), all ratings will turn to **VIEW** (or **BLOCK**) automatically.

TV-Y	()	[VIEW]
TV-Y7	()	[VIEW]
TV-G	()	[BLOCK]
TV-PG	()	[BLOCK]
TV-14	()	[BLOCK]
TV-MA	()	[BLOCK]

- 5** Press **SETUP** to save your settings and remove the menus.

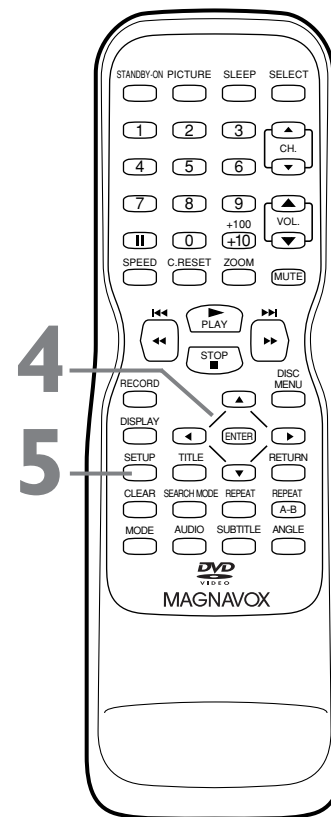

Helpful Hints

- If you want to disable V-Chip so you can view all TV programming, set TV-Y to VIEW.
- The V-CHIP settings will be retained after a power failure (except the access code reverts to 0000).

44 Setting V-Chip (cont'd)

TV Rating Subratings

When you select TV-Y7, TV-PG, TV-14, or TV-MA, you can use the subratings to block specific elements of programming, such as language or violence.

1 Press **SETUP**.

2 Press **▲** or **▼** to select **V-CHIP SET UP**. Press **ENTER**.

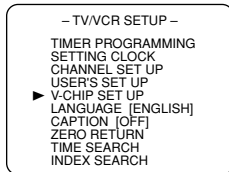

3 Press the **Number** buttons to enter the **four-digit access code**. The default code is 0000 (if you have not set up your own code yet or if there has been a power failure).

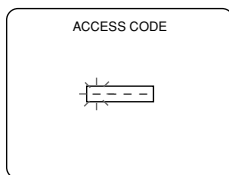

4 Press **▲** or **▼** to select **TV RATING**. Press **ENTER**.

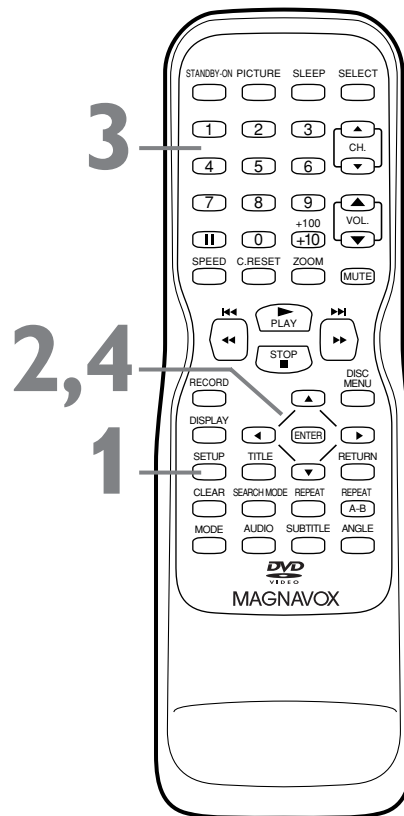
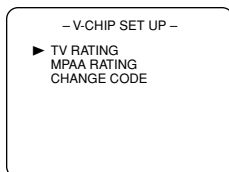

Setting V-Chip (cont'd) 45

- 5** Press ▲ or ▼ to select the rating you wish to adjust. Then, press ENTER twice to go to its subratings.

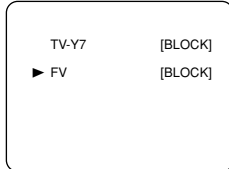

Example:
TV-Y7 subratings

- **When you select TV-Y7:**
Press ▲ or ▼ to select FV (Fantasy Violence, violence that seems realistic to young children). Then, press ENTER to select BLOCK or VIEW.
- **When you select TV-PG, TV-14, or TV-MA:**
Press ▲ or ▼ to select “D” (Suggestive Dialog), “L” (Coarse Language), “S” (Sexual Situation), or “V” (Violence). Then, press ENTER repeatedly to select BLOCK or VIEW for each subrating. To go to the previous menu, press RETURN.

- 6** Press **SETUP** to save your settings and remove the menus.

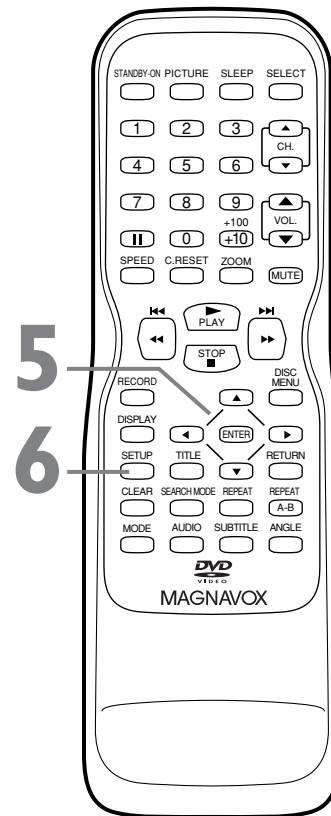

Helpful Hints

- Dialog (D) is not an available subrating for TV-MA.
- Blocked subratings will appear beside the rating category in the TV ratings menu.
- You cannot BLOCK a subrating (D, L, S, or V) if the main category is set to VIEW. However, you can set a subrating to VIEW even when the main category is set to BLOCK.
- Changing the category to BLOCK or VIEW automatically changes all its subratings to the same (BLOCK or VIEW).

46 Setting V-Chip (cont'd)

MPAA Rating Settings

You can block TV channel viewing according to the Motion Picture Association ratings. To do so, follow these steps.

1 Press **SETUP**.

2 Press **▲** or **▼** to select **V-CHIP SET UP**. Then, press **ENTER**.

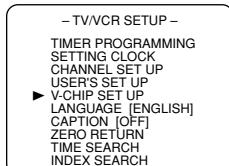

3 Press the **Number** buttons to enter the **four-digit access code**. (The default code is 0000 if you have not set up your own code yet or if the power has failed.)

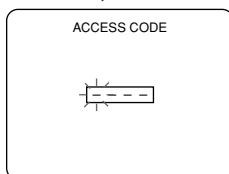

4 Press **▲** or **▼** to select **MPAA RATING**. Then, press **ENTER**.

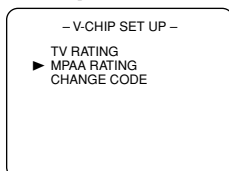

5 Press **▲** or **▼** to select the level at which you want to block viewing. Then, press **ENTER** to select **BLOCK** or **VIEW**.

When you Block a category, higher ratings turn to BLOCK automatically. Lower ratings turn to VIEW. When you set G to VIEW or BLOCK, all ratings turn to VIEW or BLOCK automatically.

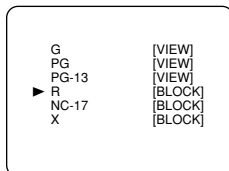

6 Press **SETUP** to save your settings and remove the menus.

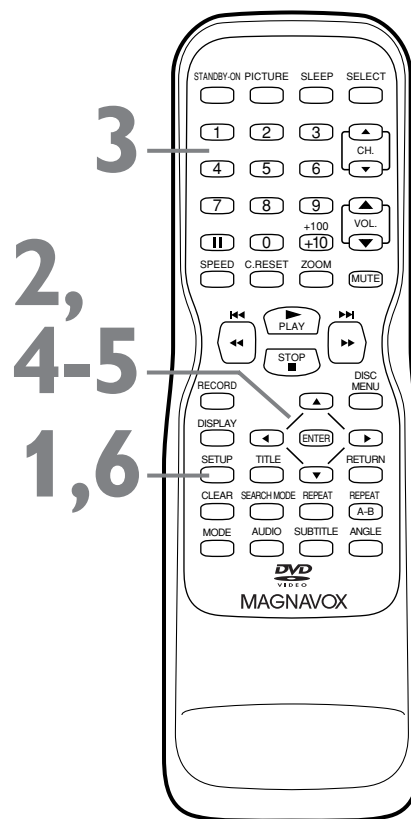

MPAA Rating Explanations

- G - General Audience
- PG - Parental Guidance suggested.
- PG-13 - Unsuitable for children under 13
- R - Restricted; under 17 requires accompanying parent or adult guardian
- NC-17 - No one under 17 admitted
- X - Mature audience only

Helpful Hints

- To disable all the MPAA Ratings, set G to VIEW.
- The V-CHIP settings will be retained after a power failure (except the access code reverts to 0000).

Setting V-Chip (cont'd) 47

Changing the Access Code

Although the default code 0000 is supplied with the TV/VCR/DVD, you can set your own access code.

- 1** Press **SETUP**.
- 2** Press **▲** or **▼** to select **V-CHIP SET UP**. Then, press **ENTER**.
- 3** Press the **Number** buttons to enter the old access code. When doing this for the first time, use 0000. Four Xs will appear instead of the code to protect its identity.

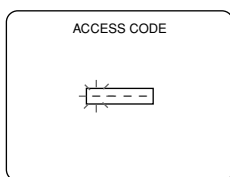

- 4** Press **▲** or **▼** to select **CHANGE CODE**. Then, press **ENTER**.

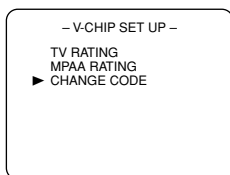

- 5** Press the **Number** buttons to enter your preferred access code in the **NEW CODE** space. Then, enter the same code in the **CONFIRM CODE** space. Again, Xs will appear instead of the code numbers. The access code must have exactly four digits.

The V-CHIP SET UP screen will reappear.

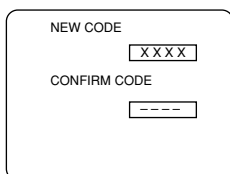

- 6** Press **SETUP** to save your settings and remove the menus.

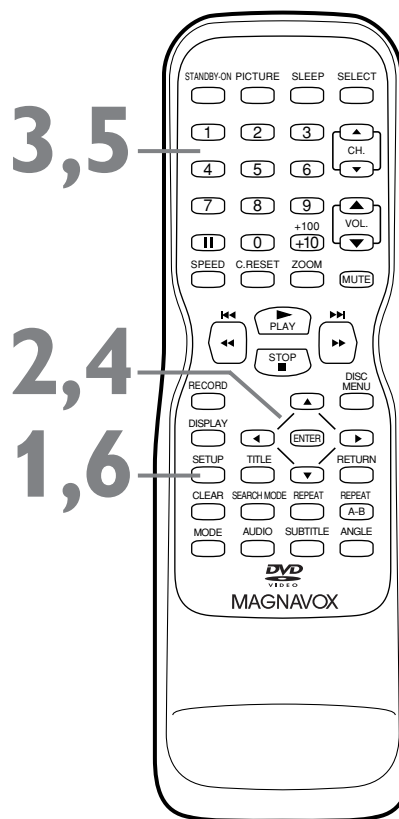

Helpful Hints

- If you enter the wrong code in the **CONFIRM CODE** space, repeat step 5. Enter the same new code exactly in the **CONFIRM CODE** space.
- If you unplug the power cord or if the power fails, the default code will be active again (0000). Change your access code again as necessary.

48 Multi-Channel Television Sound

- 1** Press **DISPLAY** to see the sound status. During TV viewing, press DISPLAY twice. During tape play, press DISPLAY once.

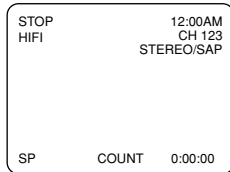

When a TV program is broadcast in stereo, STEREO appears in the top right corner of the screen. When a TV program is broadcast in second audio, SAP appears in the top right corner of the screen. When a TV program is broadcast both in stereo and second audio, STEREO and SAP both appear.

Although a program may be broadcast in both stereo and second audio, you cannot record in both stereo and second audio at the same time.

During tape play, HIFI will appear in the top left corner of the screen if VCR AUDIO is set to HIFI. *Details are on page 49.* If you play non-HiFi tapes while VCR AUDIO is set to HIFI, HIFI will disappear from the screen. The videotape will play in monaural sound. You must set the TV/VCR/DVD to record in either STEREO or SAP. Do this by changing the TV AUDIO setting as described on page 50.

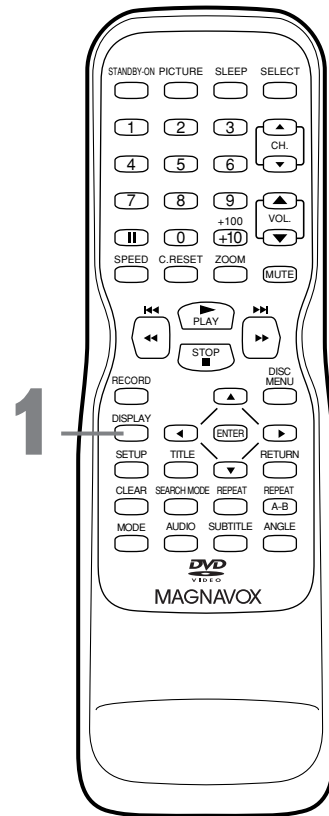

Multi-Channel Television Sound (cont'd) 49

Selecting HiFi or Monaural Sound

You can play videotapes in either High Fidelity (HIFI) or Monaural (MONO or single-channel) sound. To do so, follow these steps.

1 Press **SETUP**.

2 Press **▲** or **▼** to select **USER'S SET UP**. Then, press **ENTER**.

– TV/VCR SETUP –
 TIMER PROGRAMMING
 SETTING CLOCK
 CHANNEL SET UP
 ▶ USER'S SET UP
 V-CHIP SET UP
 LANGUAGE [ENGLISH]
 CAPTION [OFF]
 ZERO RETURN
 TIME SEARCH
 INDEX SEARCH

3 Press **▲** or **▼** to select **VCR AUDIO**.

– USER'S SET UP –
 RENTAL [ON]
 REPEAT PLAY [OFF]
 AUTO RETURN [OFF]
 ▶ VCR AUDIO [HIFI]
 TV AUDIO [STEREO]

4 Press **ENTER** to select **MONO** or **HIFI**.

– USER'S SET UP –
 RENTAL [ON]
 REPEAT PLAY [OFF]
 AUTO RETURN [OFF]
 ▶ VCR AUDIO [HIFI]
 TV AUDIO [STEREO]

5 Press **SETUP** to exit the menus.

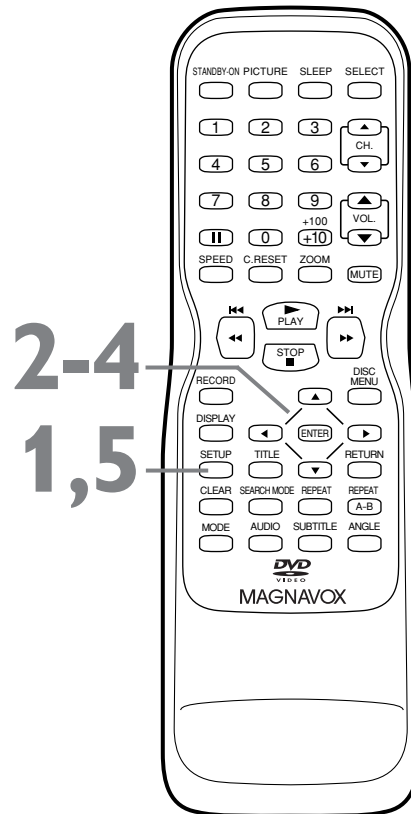

Helpful Hints

- Non-HiFi tapes will play in monaural sound automatically.
- MTS broadcasts automatically record in HiFi unless you select SAP before recording. Details are on page 50.

50 Multi-Channel Television Sound (cont'd)

Setting the TV/VCR/DVD to receive or record TV programs in Stereo, Second Audio, or Monaural Sound

Because TV channels can broadcast in Stereo or Second Audio, set the TV/VCR/DVD to receive and record the channels in the sound mode you prefer.

- 1 Press **SETUP**. Press **▲** or **▼** to select **USER'S SET UP**. Then, press **ENTER**.

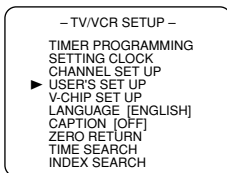

- 2 Press **▲** or **▼** to select **TV AUDIO**.

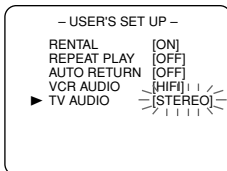

- 3 Press **ENTER** to select **STEREO**, **SAP** (Second Audio Program), or **MONO**.

- 4 Press **SETUP** to exit the menus.

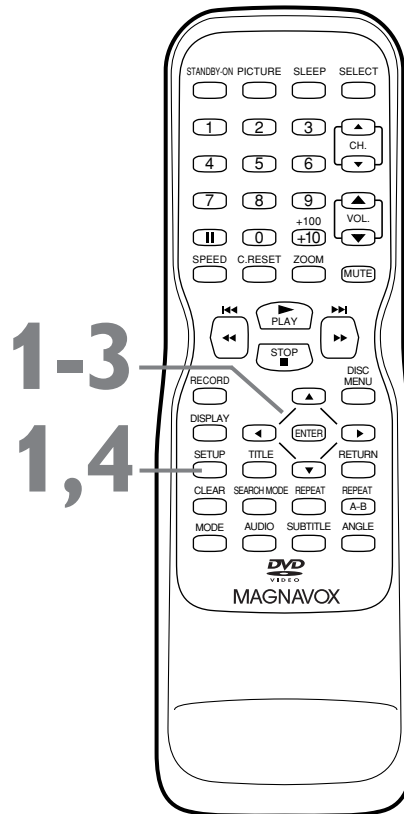

Helpful Hint

- If you select second audio when second audio is not available, the TV/VCR/DVD will receive and record normal audio.

Disc Menu, Title Menus 51

Disc Menus

Some DVDs contain menus that describe the contents of the Disc or allow you to customize Disc playback. For example, the menu may offer choices for subtitle languages, special features, or scene selection.

To use the DVD Disc menu and select playback features, follow these steps.

- Before you begin, press **SELECT** to put the TV/VCR/DVD in DVD mode.

- 1 Press DISC MENU.**
The DVD's Disc menu will appear.
- 2 Press ▲▼◀▶ to select an item, then press ENTER.** Continue this process to set up all the features you want or to start Disc playback.

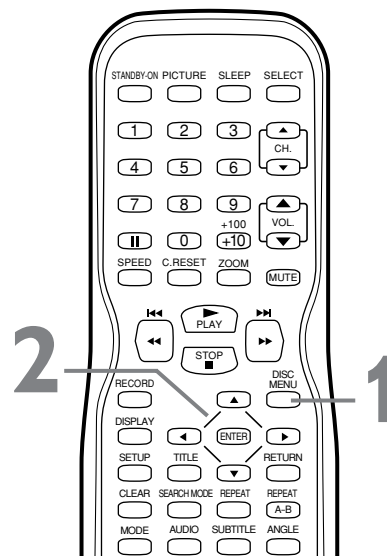

Title Menus

Some DVDs have a Title Menu, which lists the Titles available on the Disc. Use the Title Menu to play a specific Title.

- Before you begin, press **SELECT** to put the TV/VCR/DVD in DVD mode.

- 1 While Disc play is stopped, press TITLE.**
The Title Menu will appear.
If a Title menu is not available, the "X" may appear on the TV screen. If the DVD only has a main menu as described above, it may appear when you press **TITLE**.
- 2 Press ▲▼◀▶ to select a Title, then press ENTER.** Play will begin at the Title you selected.

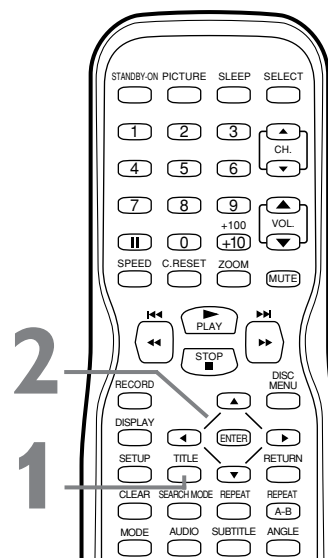

Helpful Hints

- Menus vary among Discs. Follow the information with the DVD.
- Not all DVDs have Title menus.
- Some DVDs may refer to Chapters as "scenes." Some DVDs may refer to the Title Menu as the "scene index."
- The **TITLE** button may not be active with all DVDs.

52 Fast Forward/Reverse Search

1 During Disc play, press and hold **▶▶/▶▶** or **◀◀/◀◀** on the remote for two seconds.

- During DVD play, pressing and holding **▶▶/▶▶** or **◀◀/◀◀** will forward or reverse the picture at two, eight, 50, or 100 times the normal playback speed.

An **◀◀ 2**, **◀◀ 8**, **◀◀ 50**, or **◀◀ 100** will appear briefly on the TV screen to indicate reverse searching. Or, **▶▶ 2**, **▶▶ 8**, **▶▶ 50**, or **▶▶ 100** will appear briefly on the TV screen to indicate fast forward searching. Sound will be mute during searching.

- During Audio CD play, you may search only at 16 times the normal playback speed. An **◀◀ 16** or **▶▶ 16** will appear briefly on the TV screen. Sound will be intermittent during searching on an Audio CD.



Example:
Playing a DVD in reverse at twice the normal playing speed.

- During MP3 play, you can search at only eight times the normal speed. An **◀◀ 8** or **▶▶ 8** will appear briefly on the TV. Sound will be intermittent during searching of MP3 Tracks.

2 Press **PLAY ▶** to return to normal playback.

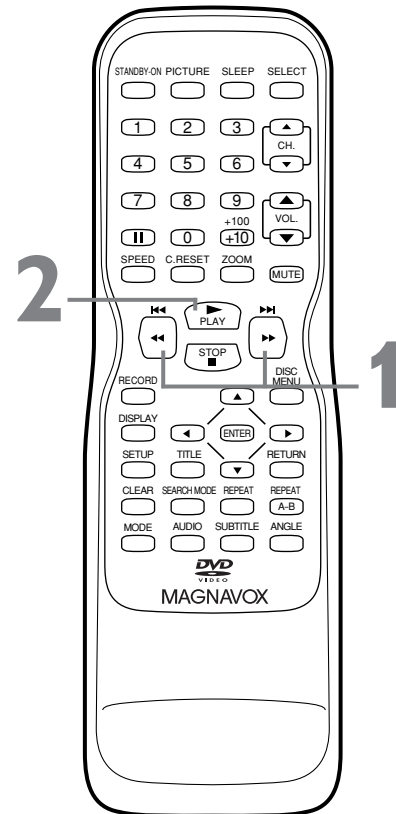

Title/Chapter Playback, Time Playback 53

Title/Chapter Playback

- 1 During DVD play, press **SEARCH MODE** until CH (for Chapter) or TT (for Title) appears on the TV screen. The number of available Titles or Chapters will appear at the right (/4, for example).

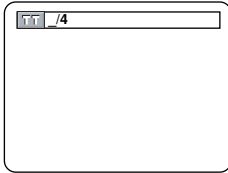

- 2 Enter the Title or Chapter number using the **Number buttons**. Precede a single-digit Title or Chapter number with a zero (01...09). The selected Title or Chapter will start to play.

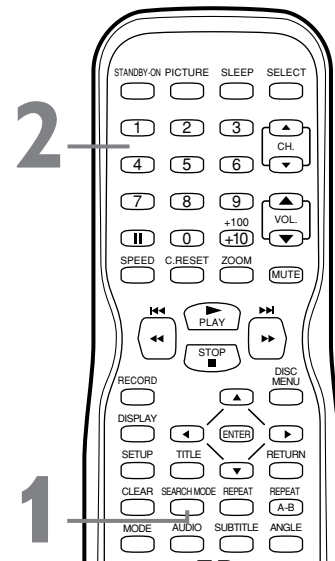
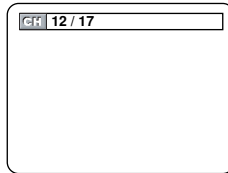
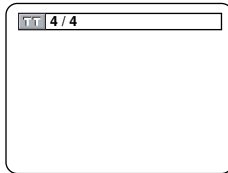

Time Playback

- 1 During DVD or Audio CD play, press **SEARCH MODE** until the Time Search display appears.

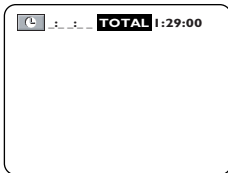

- 2 Within 30 seconds, use the **Number buttons** to enter the elapsed playing time (of the current Track or Title) at which you want play to begin. Enter the time in hours, minutes, and seconds. Within a few seconds, play will start at the specified time.

- Example: 1 hour, 23 minutes, and 30 seconds
1 → 2 → 3 → 3 → 0
- Make sure the time you enter is within the total time of the current Title or Track. If it is not, the time space will clear and play will continue at its current point. The total time available in the current Track or Title will appear at the right of the display beside TOTAL.
- If you make a mistake entering the time, press CLEAR to clear the time area. Enter the correct information.

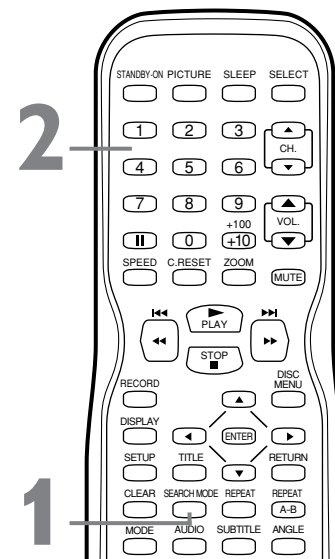

Helpful Hint

- Title/Chapter playback is not available with some DVDs.

54 Track Play

There are three ways to play a Track on an Audio CD. Use the Number buttons, the SEARCH MODE button, or **▶▶|▶▶** and **◀◀|◀◀**.

- **Before you begin, press SELECT to put the TV/VCR/DVD in DVD mode. Make sure an Audio CD is in the disc tray.**

A

Using the Number Buttons

Press the Number buttons to enter a Track number.

Play will start at the selected Track.

For single-digit Tracks (1-9), press a single Number button. For Tracks 10 and above, press the +100/+10 button so the Search display (TR - -) appears on the TV. Press the Number button of the first digit, then press the Number button of the second digit. For example, to play Track 26, press +100/+10, then Number 2, then Number 6.

If you enter a Track number that is not available on the Disc, play will not begin (or the current Track will continue to play).

B

Using SEARCH MODE

Press SEARCH MODE so the Track Search display (TR) appears. Within 30 seconds, press the Number buttons to select the Track number. Play will begin at the selected Track. For a single-digit Track (1-9), enter a zero first. For example, to play Track 5, press 0, 5. You do not have to use the +100/+10 button in Search Mode for Tracks 10 and above.

C

Using **▶▶|▶▶** and **◀◀|◀◀**

During play, press **▶▶|▶▶ to skip the current Track and move to the next Track. Press **◀◀|◀◀** to return to the beginning of the current Track or to go to previous Tracks.**

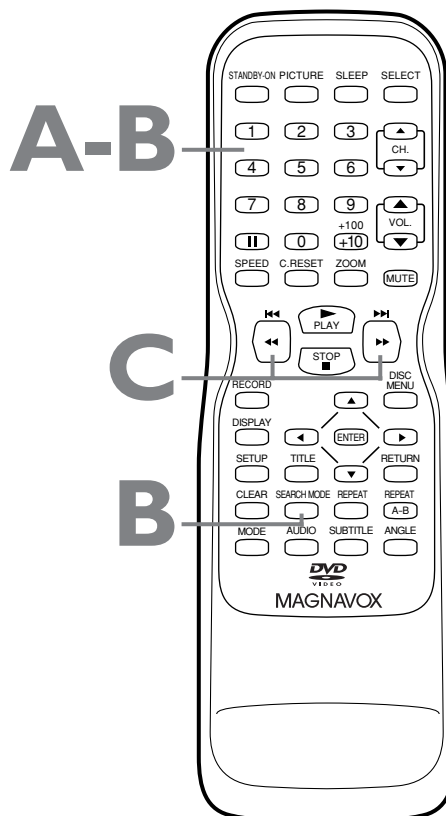

Helpful Hints

- The **◀◀|◀◀** and **▶▶|▶▶** buttons are not active when play is stopped.
- You cannot use **▶▶|▶▶** to go from the last Track on the Disc to the first Track.

Paused and Step-by-Step Play, Resume On 55

Paused and Step-by-Step Play

- 1** During Disc play, press **II** (pause). Play will pause and the sound will be mute.
- 2** When playing a DVD, press **II** (pause) repeatedly to see the picture advance one frame (or step) at a time. The sound will remain mute. Pressing PAUSE repeatedly during Audio CD, MP3, or JPEG play will have no effect.
- 3** Press **PLAY** ► to resume play.

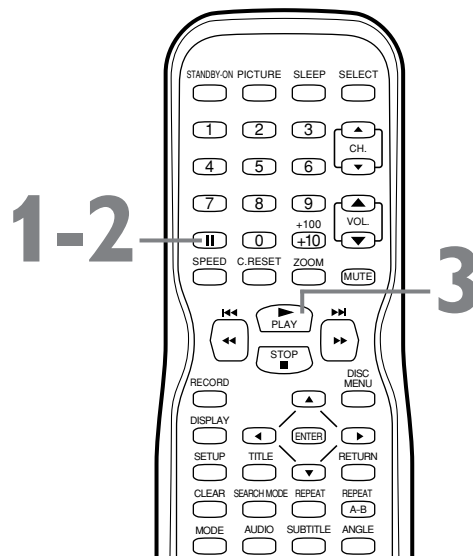

Resume On

You may choose to resume play from the point at which it stopped last.

- 1** Press **STOP** ■ during DVD or Audio CD play. In a few seconds, the following Resume message will appear on the TV screen. (The file list will appear during MP3 or JPEG playback.)

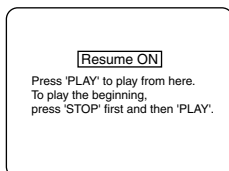

- 2** Press **PLAY** ►. In a few seconds, play will resume from the point at which it stopped last. Opening the disc tray or turning off the TV/VCR/DVD will cancel the Resume feature. Play will start at the beginning the next time you play the Disc.
Or, to cancel Resume and start playing the Disc from the beginning, press **STOP** ■ a second time while play is stopped. The Stop symbol (■) will appear briefly in the upper right corner of the TV screen. Press **PLAY** ► to start playing the Disc from the beginning.

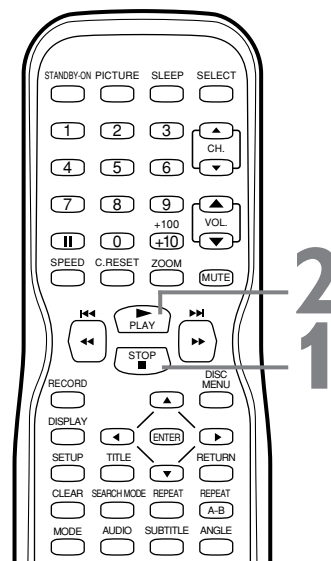

Helpful Hints

- In some cases, you need to press **PLAY** ► while the Resume message appears in order to resume play from the same point.
- Resume On is not available for MP3 or JPEG files.

56 Repeat Play, A-B Repeat Play

Repeat Play

- During DVD or Audio CD play, press **REPEAT** until the repeat mode you want appears on the TV. On a DVD, select **CHAPTER**, **TITLE**, or **OFF**. On an Audio CD, select **TRACK**, **ALL** (all Tracks on the Disc), or **OFF**. With MP3 files you can select **TRACK**, **ALL**, or **GROUP** (all Tracks in the current Folder). Selecting a new Track, Chapter, or Title will cancel repeat play.

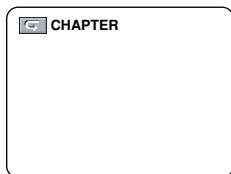

Example

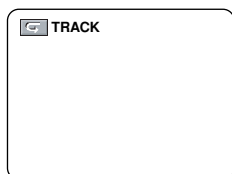

Example

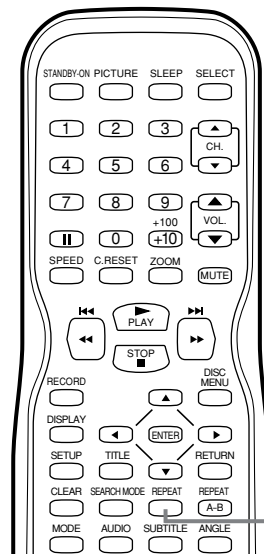

A-B Repeat Play

You can play a section of an Audio CD or DVD repeatedly. Follow these steps to set up the section you want to play.

- During Disc play, press **REPEAT A-B** to set the starting point (**A**). If you make a mistake, press **CLEAR**. This will erase point A and let you start over. **OFF** will appear briefly on the TV screen.

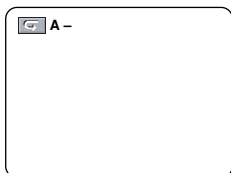

- Play the Disc to the point at which you want repeated play to end, then press **REPEAT A-B** again. Within a few seconds, the section will begin to play. The segment will play over and over until you cancel the A-B Repeat feature.

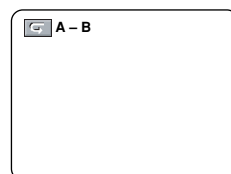

- To cancel A-B Repeat Play, press **REPEAT A-B** so **OFF** appears on the TV screen.

Regular play will resume.

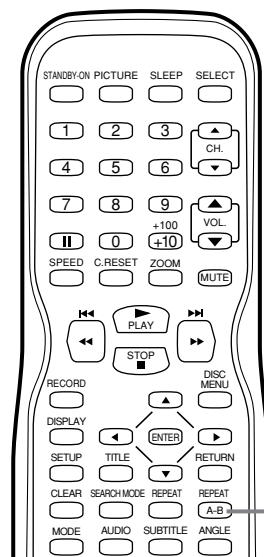

Helpful Hints

- Repeat play is not available with some Discs.
- The entire A-B Repeat section must be within a single Title or Track. If you do not enter Point B before the end of the Track/Title is reached, the end of the Track or Title will become Point B.
- Point B must be later on the Disc than Point A.
- A-B Repeat is not available with MP3 Tracks.
- Stopping play will cancel A-B Repeat Play.

Markers 57

Use Markers to remember your favorite places on an Audio CD or DVD. To set the Markers, follow these steps.

- 1 Play the Disc to within 30 seconds prior to the point at which you want to set the Marker. **During play, press SEARCH MODE until the Markers appear at the top of the TV screen.**

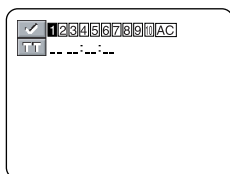

DVD example

- 2 Within 30 seconds, press ◀ or ▶ to select a Marker (1-10). Make sure _ _ : _ _ : _ _ appears beneath the number.
- 3 Let the Disc play to the point at which you want to set the Marker (up to 30 seconds away). **When the Disc reaches the point you want to remember, press ENTER.** The Title number and elapsed playing time (DVD) or Track number and its elapsed playing time (Audio CD) will appear. A checkmark will replace the Marker number. The Marker display will disappear in about 30 seconds, or press SEARCH MODE again to remove the Marker display.

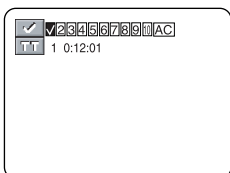

DVD example

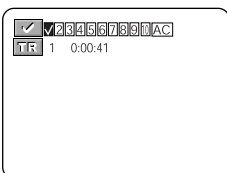

Audio CD example

- 4 To return to a Marker during play, press SEARCH MODE until you see the Markers. Press ◀ or ▶ to choose the Marker you want, then press ENTER. Disc play will continue from the marked point.

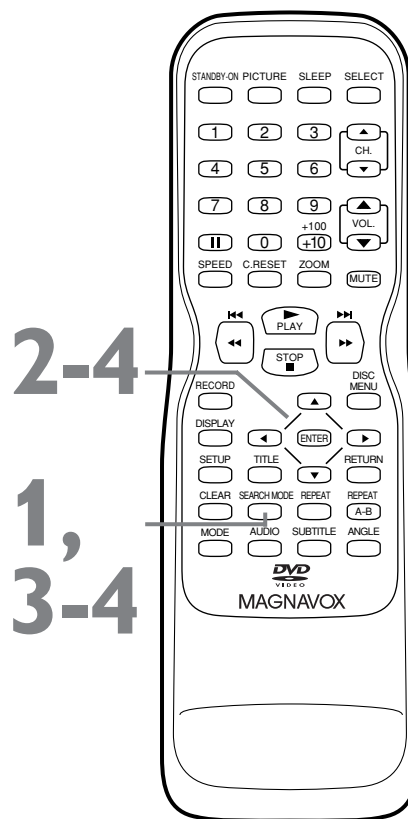

Helpful Hints

- Opening the disc tray, switching to TV/VCR mode, or turning off the TV/VCR/DVD will erase all the Markers.
- To erase a single Marker, press SEARCH MODE until you see the Markers. Press ◀ or ▶ to select a Marker. Press CLEAR. Press RETURN to remove the display.
- To erase all the Markers, press SEARCH MODE until you see the Markers. Press ▶ to select AC (All Clear), then press ENTER. Press SEARCH MODE or RETURN to remove the display.

58 Subtitles, Camera Angles

Subtitles

You can select a language for DVD subtitles during playback. You may select only the subtitles that are available on the Disc.

- 1 **During play, press SUBTITLE to select a subtitle language.** The number of available languages appears at the right of the subtitle display. In the example below, six languages are available (/6). After a few seconds, the subtitles will appear. Or, press SUBTITLE repeatedly to turn off subtitles.

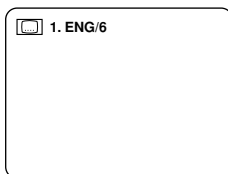

Example:
English as first of six available subtitles

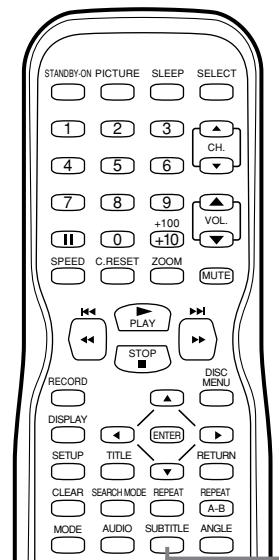

Camera Angles

Some DVDs contain scenes recorded from different angles. The camera angle will not change if the DVD does not contain sequences recorded from different camera angles.

- 1 **During play, press ANGLE to select a different angle.** The number of available angles appears at the right of the Angle display. In this example, eight angles are available (/8).

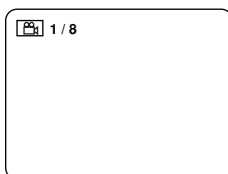

Example:
Angle 1 of eight available angles

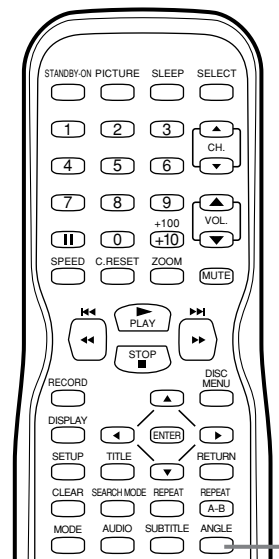

Helpful Hints

- With some DVDs, you must select a subtitle language in the Disc menu.
- If the desired language does not appear after pressing SUBTITLE several times, the Disc does not have subtitles in that language.
- Opening the disc tray or turning off the TV/VCR/DVD will cancel your subtitle setting.
- If the current portion of the Disc has multiple camera angles,  will appear on the TV screen. ANGLE ICON must be ON. Details are on pages 70-71.

Slow Motion, Zoom 59

Slow Motion

- 1** Press **II** (pause) during DVD play.
- 2** Press and hold **▶▶/||▶▶** or **◀◀/||◀◀** for two seconds. Slow motion play will begin. Press and hold **▶▶/||▶▶** or **◀◀/||◀◀** repeatedly during slow motion play to play the DVD forward or backward at 1/16, 1/8, or 1/2 the normal speed.

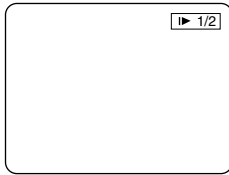

Example:
Playing a DVD forward at half the normal speed.

- 3** Press **PLAY ▶** to return to normal playback.

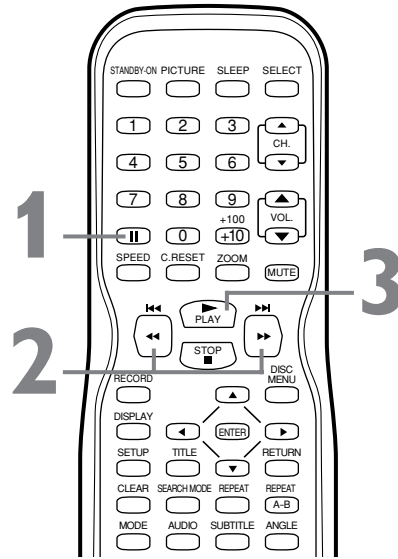

Zoom

You can enlarge the DVD picture to 1.3, two, or four times the regular size.

- 1** Press **ZOOM** during play. **ZOOM1** will appear on the screen. The picture will be 1.3 times larger. Press **ZOOM** again to increase the picture to twice the regular size. **ZOOM2** will appear. Press **ZOOM** again to increase the picture to four times the regular size. **ZOOM3** will appear.

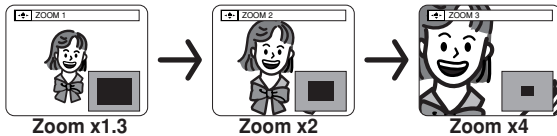

- 2** Press **▲**, **▼**, **◀**, or **▶** to move the zoomed image up, down, left, or right.



Position guide example:
The Zoomed area is in the top portion of the overall picture.

- 3** To return the picture to its normal size, press **ZOOM** repeatedly.

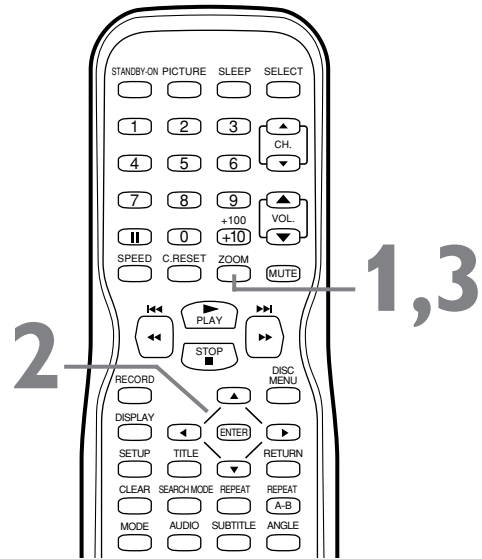

Helpful Hints

- The sound will be mute during slow motion play.
- The gray box with an inner blue box that shows during Zoomed play is the position guide. To remove it or show it, press **ENTER**. The position of the blue box inside the gray box indicates the position of the zoomed image within the overall picture.

60 Parental Password

The Parental feature prevents viewing of DVDs that exceed your rating limits. This feature will not limit viewing if the DVD is not rated or coded. Check your DVDs and settings before letting children access the TV/VCR/DVD. Follow these steps to change your password.

- Before you begin, press **SELECT** to put the TV/VCR/DVD in DVD mode.

- 1 Press **SETUP** twice while play is stopped.

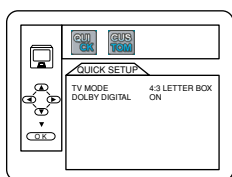

- 2 Press **▶** to select **CUSTOM** at the top of the menu, then press **ENTER**.

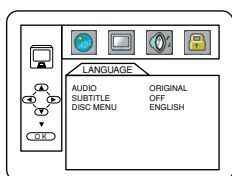

- 3 Press **▶** to select **🔒** (the lock), then press **ENTER**. The first time you set a password, this menu will appear.

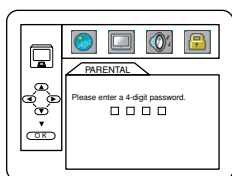

Press the **Number buttons** to enter a **four-digit password**. The password will appear on the screen. Write it down so you don't forget it.
Press ENTER. You are finished!
Go to step 6 on the next page.

If you have set a password before, this menu will appear.

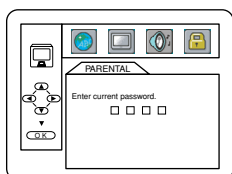

Press the **Number buttons** to enter your **current four-digit password**. Asterisks (*) will appear instead of your password. This protects its identity.

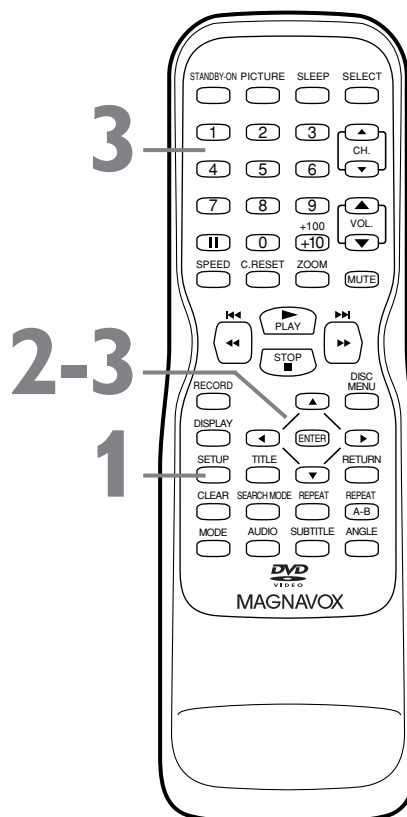

Parental Password (cont'd) 61

4 Press **▼** to select **CHANGE**, then press **ENTER**.

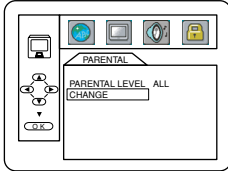

5 Press the **Number** buttons to enter a **four-digit password**. The password numbers will appear on the screen. Write down the password so you will not forget it. Press **ENTER**. The previous menu will reappear.

6 Press **SETUP** to exit the menu.

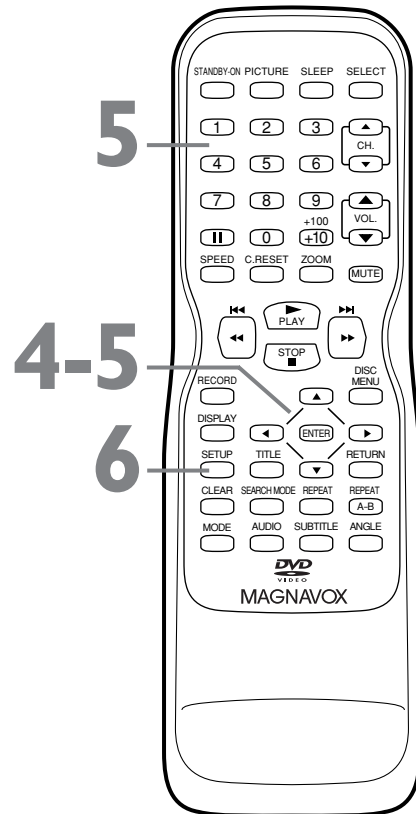

Helpful Hints

- The default password is 4737. If you forget your password, press Number buttons 4, 7, 3, 7 at step 3. You will be prompted to enter a new four-digit password. Use the Number buttons to enter a new four-digit password, then press ENTER. PARENTAL LEVEL will reset to ALL. Press SETUP to remove the menu. See pages 62-63 to reset PARENTAL LEVEL as you desire.
- A power failure will not erase your password.

62 Parental Levels

Follow these steps to set the rating level for your DVDs.
DVDs whose ratings exceed the level you set will not play.

- Before you begin, press **SELECT** to put the TV/VCR/DVD in DVD mode.

- 1 Press **SETUP** twice while play is stopped.

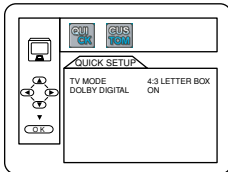

- 2 Press **▶** to select **CUSTOM** at the top of the menu, then press **ENTER**.

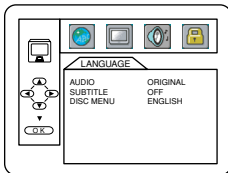

- 3 Press **▶** to select **🔒** (the lock), then press **ENTER**.

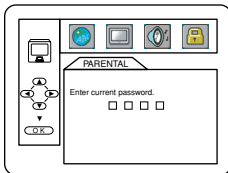

- 4 Press the **Number** buttons to enter your **four-digit password**. Asterisks (*) will appear instead of your password. This protects its identity.

- 5 Press **▲** or **▼** to select **PARENTAL LEVEL**, then press **ENTER**.

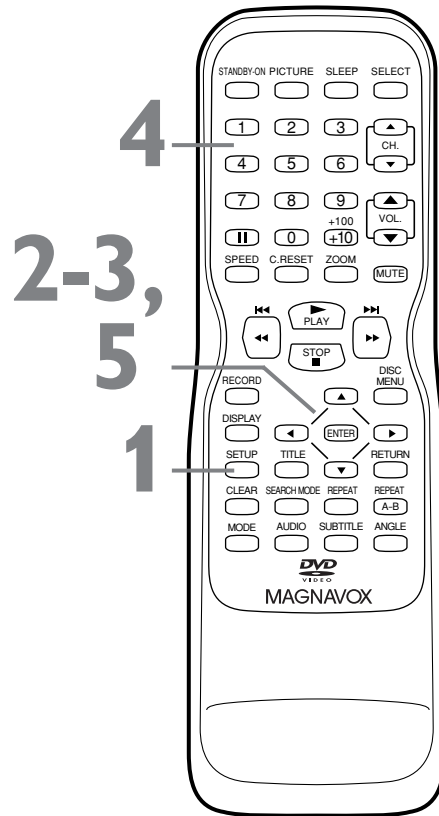
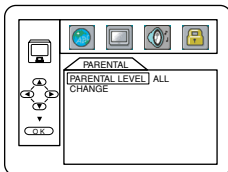

RATING EXPLANATIONS

- ALL - The Parental feature is inactive; all discs can play.
- 8 - Adult material
- 7 - NC-17 - Not appropriate for children under 17
- 6 - R - Restricted; parental approval required for viewers under 18.
- 4 - PG13 - Unsuitable for children under 13
- 3 - PG - Parental Guidance suggested.
- 1 - G - General Audience; recommended for all ages.

Parental Levels (cont'd) 63

- 6** Press **▲** or **▼** to select a level, then press **ENTER**. The rating levels continue on two menu screens. Press **▲** or **▼** repeatedly to move to the next or previous screen to find the rating level you want. After making your selection, the previous menu will appear. The level you selected will appear beside PARENTAL LEVEL.

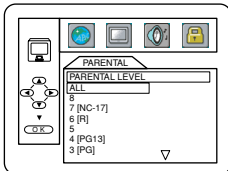

- 7** Press **SETUP** to exit the menu.

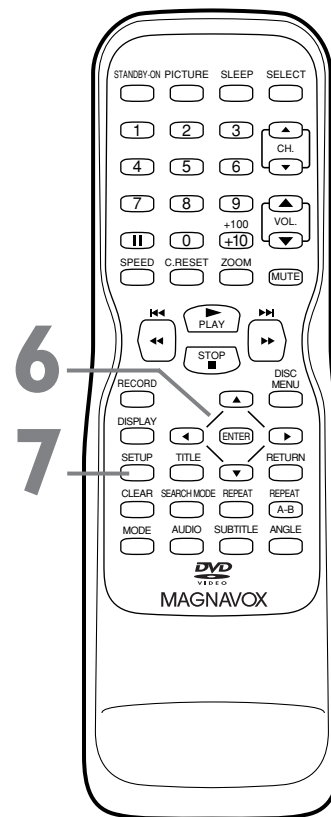

Helpful Hints

- When you try to play a DVD whose rating exceeds the level you set, an on-screen message will indicate the DVD cannot play. Remove the DVD, then set PARENTAL LEVEL to ALL. Reload the DVD and begin playback. Some DVDs may let you enter your four-digit password to begin playback. Follow the on-screen messages as prompted.
- You cannot use the default password (4737) to play a DVD.

64 Audio Language, Stereo Sound

Audio Language

You can select a language for DVDs during play if multiple languages are available.

- 1 **During DVD play, press AUDIO repeatedly to choose one of the available languages.** The new audio will be heard. The display will disappear after about five seconds.

The Audio display may show if the DVD has Dolby Digital or multi-channel (5.1 CH) sound or show its sampling rate (48k, for example). The number of available languages appears after the “ / ” at the right of the display (/3, for example).

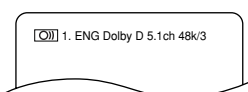

Example: English audio

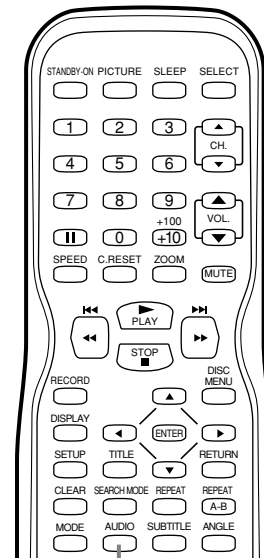

Stereo Sound

Adjust Stereo Sound to determine whether you will hear the left channel, the right channel, or both channels (stereo) during Audio CD playback.

- 1 **Press AUDIO during Audio CD play to choose STEREO, L-CH, or R-CH.** The display will disappear in about five seconds.

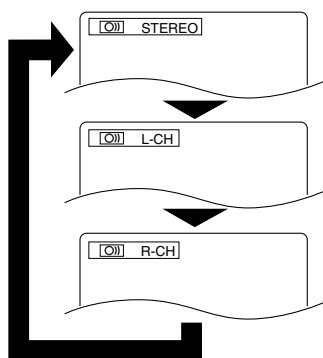

Both right and left channels are heard (stereo).

Only the left channel is heard.

Only the right channel is heard.

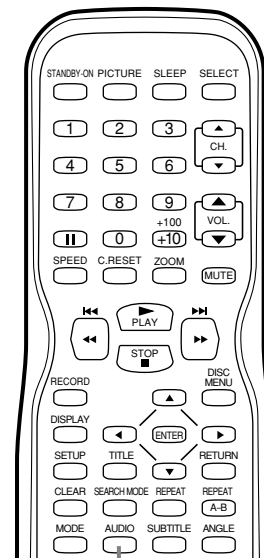

Helpful Hints

- If a language is not available after pressing AUDIO several times, the DVD does not have that language.
- Some DVDs only let you change the language in the Disc menu.
- Audio languages may be abbreviated (such as ENG for English). Or, three dashes (- - -) may appear instead of an abbreviation.
- You can adjust Stereo Sound only when Virtual Surround is OFF. Details are on page 74.

Random Play, Programmed Play 65

Random Play

You may play the Tracks of an Audio CD in Random order instead of the order in which they are recorded (1,2,3...). You can also use this feature for JPEG and MP3 files.

- 1 While play is stopped, press **MODE** until the **RANDOM** screen appears.

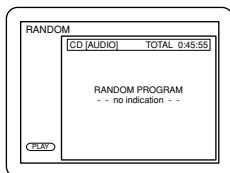

Example: Audio CD

- 2 While the **RANDOM** screen appears, press **PLAY** ►. The Tracks will play in random order. After all the Tracks have played once, play will stop.

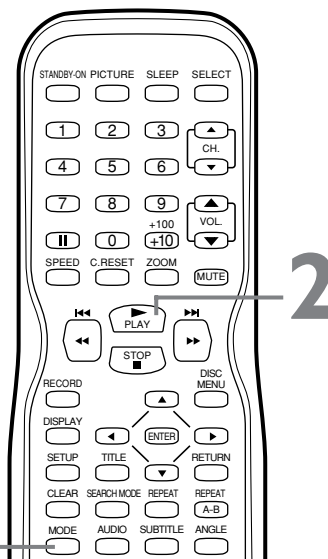

Programmed Play

You may determine the order in which Audio CD Tracks will play. You also can program MP3 or JPEG files to play in a special order. To set a Program, follow these steps.

- 1 While play is stopped, press **MODE** until the **PROGRAM** screen appears.

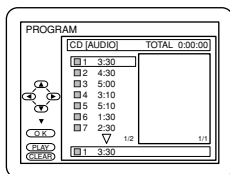

Audio CD example

- 2 Press **▲** or **▼** to select a track you want to play, then press **ENTER**. Press **CLEAR** to erase the last Track in the Program if you make an error. Additional Tracks may be on other screens. Press **▼** or **▲** to see all the Tracks. Repeat this step until you have selected all the Tracks you wish to play in the Program. A Program can have a maximum of 99 Tracks.
- 3 Press **PLAY** ►. The Tracks will play once in the order you set. Turning off the TV/VCR/DVD, switching the unit to TV/VCR mode, or opening the disc tray will erase the Program. You can start Program play only while in the **PROGRAM** screen.

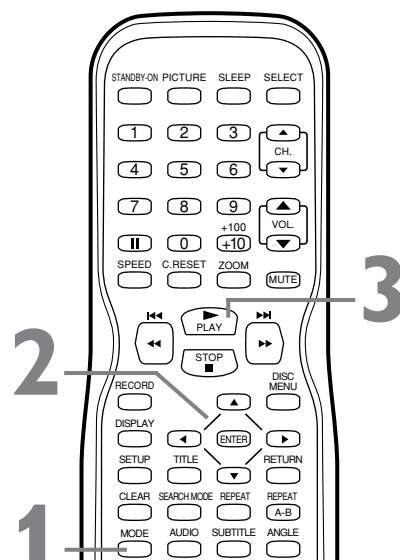

Helpful Hints

- You cannot use the Number buttons or **SEARCH MODE** to select another Track while playing a Program. Press **▶▶▶/▶▶▶** or **◀◀◀/◀◀◀** to select other Tracks in the Program.
- You cannot combine random play with programmed play.
- You may play a Program or a Track within a Program repeatedly. During programmed play, press **REPEAT** so **ALL** (all Tracks in the Program) or **TRACK** appears.
- You cannot alter a Program during play.

66 MP3/JPEG Playback

The DVD Player will play MP3 or JPEG files that you record and finalize on a CD-RW (Compact Disc-Rewritable) or CD-R (Compact Disc-Recordable).

These Discs may contain pictures in a JPEG format or audio Tracks in an MP3 format. For example, you may have photographic film developed by a retailer that places the pictures on a CD-R for you. These pictures may be in JPEG format. Or, you may copy or download MP3 music files from certain legal Internet sites, then copy those files onto a CD-R or CD-RW.

You cannot make or record such Discs using the TV/VCR/DVD. See your computer manual for details on recording.

Keep these characteristics in mind when making Discs you intend to play on the DVD Player of the TV/VCR/DVD.

- Record MP3 Tracks at a sampling frequency of 44.1 kHz or 48 kHz. Use a bit rate between 112 kbps and 320 kbps.
- When recording JPEG Files, the size of the picture should be between 32 x 32 and 6300 x 5100 dots.

- **Before you begin, press SELECT to put the TV/VCR/DVD in DVD mode.**

1 When you put a CD-RW or CD-R with MP3 or JPEG files in the Player, play may begin automatically. Or, the File List may appear on the TV screen. Press **▲** or **▼** to select a **Folder, MP3 Track, or JPEG File**.

2 If you choose a **Track or File**, press **PLAY ►** or **ENTER**. Starting with the Track or File you selected, the Tracks/Files will play in the order they were recorded, i.e. 1, 2, 3.

If you select a **Folder** and press **ENTER**, the **Tracks or Files within that Folder will appear**. Press **▲** or **▼** to select the **Track or File you want**, then press **PLAY ►** or **ENTER**.

- Choose **FIRST PLAY** to start play from the first individual File or Track listed.
- Press **TITLE** to return to the first item on the first MP3 or JPEG screen. You also can press **◀** to return to previous screens.
- During JPEG playback, press **MODE** until you see **JPG 1** or **JPG 2**. Then, within five seconds, press **ENTER** to switch between **JPG 1** and **JPG 2**. If you choose **JPG 1**, the images will cut in and out sharply as play progresses. If you choose **JPG 2**, the images will fade in and out as play progresses. For example, File 1 will fade out, then File 2 will appear, gradually "fading in."

3 To stop play, press **STOP ■**.

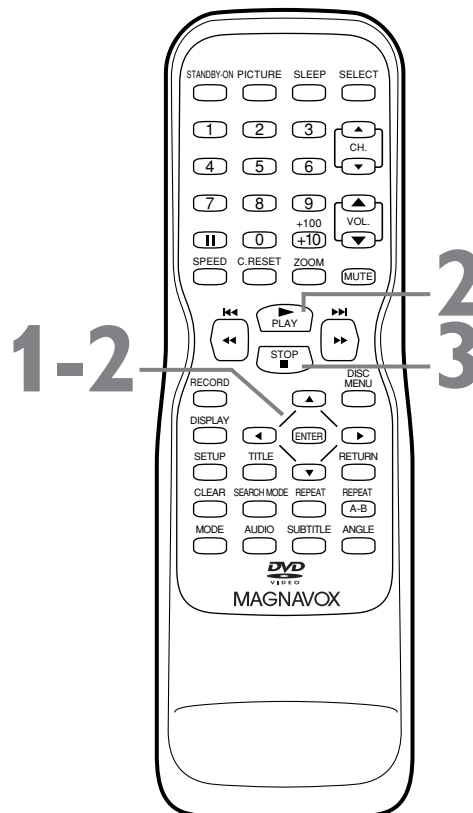

Helpful Hints

- JPEG images and MP3 Tracks are known as Files. Groups of Files are called Folders.
- JPEG Files have the ☺ icon.
- A maximum of 255 Folders can be recognized. A maximum of 256 Files can be recognized.
- MP3 Files have the 🎵 icon.
- During play, press the Number buttons to select another Track. Or, press **▶▶▶/▶▶▶** or **◀◀◀/◀◀◀** to change Tracks. If a Track is not available, "X" will appear on the TV screen. Play may resume at an incorrect Track or may continue with its current Track.
- Specific Time playback is not possible with MP3 Tracks.
- To see the File List during play, press **SEARCH MODE**. The current Track or File will be highlighted.

MP3/JPEG Displays 67

You can review MP3 and JPEG Track (File) information during playback.

- 1 Press **DISPLAY** until the current Track/File number, total Tracks/Files available, and elapsed playing time of the current Track appear. The elapsed playing time will not show during JPEG play.

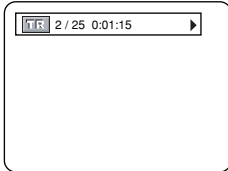

The following may appear to indicate Repeat play.



- T: The current Track will play repeatedly.
- G: Tracks in the current Folder (Group) will play repeatedly.
- A: All Tracks on the Disc will play repeatedly.

- 2 Press **DISPLAY** again to remove the display.

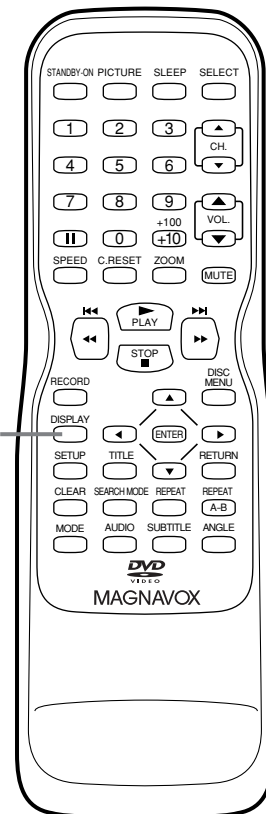
1-2



Helpful Hints

- During MP3 playback, the  icon and the current Track name will appear when you first press DISPLAY.
- During JPEG play, the  icon and the current File name will appear when you first press DISPLAY.

68 Language Settings

You can use the LANGUAGE settings to select different languages for the Audio or Subtitles of DVDs, as well as languages for DVD Disc menus.

- Before you begin, press **SELECT** to put the TV/VCR/DVD in DVD mode.

1 While play is stopped, press **SETUP** twice. The QUICK SETUP screen appears.

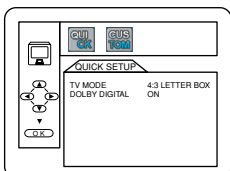

2 Press **▶** to select **CUSTOM** at the top of the menu, then press **ENTER**.

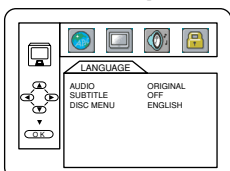

3 The Language menu () will be selected. Press **ENTER**.

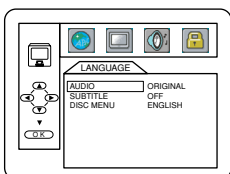

4 Press **▲** or **▼** to select **AUDIO**, **SUBTITLE**, or **DISC MENU**. Then, press **ENTER**. The language options for the selected item will appear.

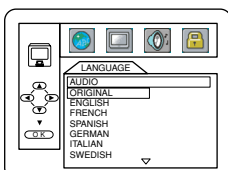

AUDIO:
The DVD's audio plays in the selected language.

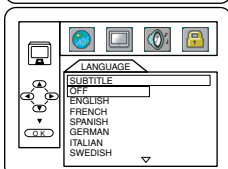

SUBTITLE:
Subtitles appear in the chosen language.

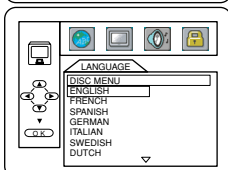

DISC MENU:
A DVD's Disc menu appears in the chosen language.

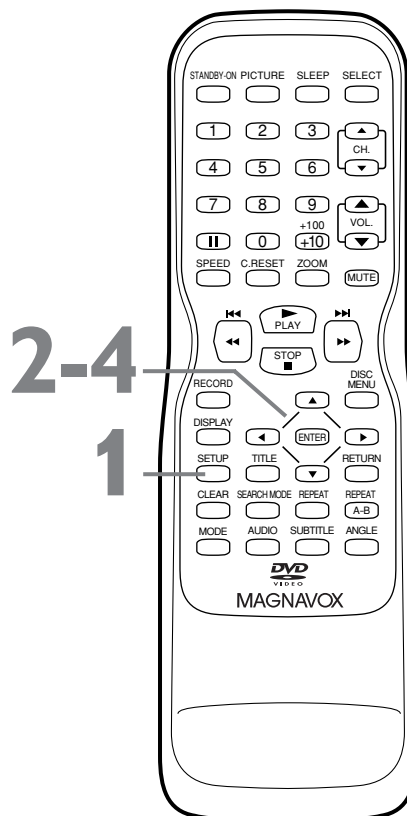

Helpful Hints

- If the DVD's default settings for Audio and Subtitle are the same language, the subtitles may not show unless you turn them on.
- Use the AUDIO and SUBTITLE buttons to select Audio and Subtitles available on the DVD. Details are on pages 58 and 64.
- If you set AUDIO to ORIGINAL, the default setting of the DVD Audio will play.

Language Settings (cont'd) 69

- 5** Press **▲** or **▼** to select a language, then press **ENTER**. The language lists may continue on multiple screens. Press **▲** or **▼** to move to the other screens.
- If you select **OTHER**, press four Number buttons to enter the code for the language you desire. Use the Language Codes below. The language or language code you select will appear in the Language menu beside **AUDIO**, **SUBTITLE**, or **DISC MENU**.

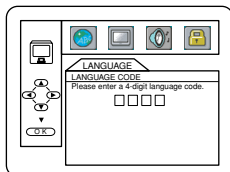

- You can select other languages only if the language is available on the Disc. If the language is not recorded on the DVD, changing these settings will have no effect.

- 6** Press **SETUP** to exit the menu.

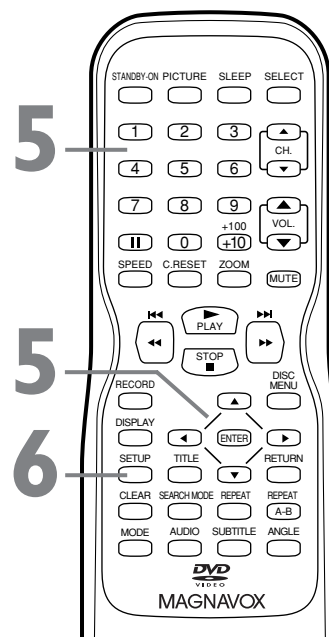

Language Codes

A-B	English	5160	Kannada	5760	Panjabi	6247	T		
Abkhazian	4748	Esperanto	5161	Kashmiri	5765	Pashto	6265	Tagalog	6658
Afar	4747	Estonian	5166	Kazakh	5757	Persian	5247	Tajik	6653
Afrikaans	4752	F-H		Kinyarwanda	6469	Polish	6258	Tamil	6647
Albanian	6563	Faroese	5261	Kirghiz	5771	Portuguese	6266	Tatar	6666
Amharic	4759	Fiji	5256	Kirundi	6460	Pushto	6265	Telugu	6651
Arabic	4764	Finnish	5255	Korean	5761	Quechua	6367	Thai	6654
Armenian	5471	French	5264	Kurdish	5767	Rhaeto-Romance	6459	Tibetan	4861
Assamese	4765	Frisian	5271	L-N		Romanian	6461	Tigrinya	6655
Aymara	4771	Gaelic (Scots)	5350	Laothian	5861	Russian	6467	Tonga	6661
Azerbaijani	4772	Galician	5358	Latin	5847	S		Tsonga	6665
Bangla	4860	Georgian	5747	Latvian	5868	Samoan	6559	Turkish	6664
Bashkir	4847	German	5051	Lettish	5868	Sangho	6553	Turkmen	6657
Basque	5167	Greek	5158	Lingala	5860	Sanskrit	6547	Twi	6669
Bengali	4860	Greenlandic	5758	Lithuanian	5866	Serbian	6564	U-Z	
Bhutani	5072	Guarani	5360	Macedonian	5957	Serbo-Croatian	6554	Ukrainian	6757
Bihari	4854	Gujarati	5367	Malagasy	5953		6554	Urdu	6764
Bislama	4855	Hausa	5447	Malay	5965	Sesotho	6566	Uzbek	6772
Breton	4864	Hebrew	5569	Malayalam	5958	Setswana	6660	Vietnamese	6855
Bulgarian	4853	Hindi	5455	Maltese	5966	Shona	6560	Volapuk	6861
Burmese	5971	Hungarian	5467	Maori	5955	Sindhi	6550	Welsh	4971
Byelorussian	4851	I-K		Marathi	5964	Singhalese	6555	Wolof	6961
C-E		Icelandic	5565	Moldavian	5961	Siswat	6565	Xhosa	7054
Cambodian	5759	Indonesian	5560	Mongolian	5960	Slovak	6557	Yiddish	5655
Catalan	4947	Interlingua	5547	Nauru	6047	Slovenian	6558	Yoruba	7161
Chinese	7254	Interlingue	5551	Nepali	6051	Somali	6561	Zulu	7267
Corsican	4961	Inupiak	5557	Norwegian	6061	Spanish	5165		
Croatian	5464	Irish	5347	O-R		Sundanese	6567		
Czech	4965	Italian	5566	Occitan	6149	Swahili	6569		
Danish	5047	Japanese	5647	Oriya	6164	Swedish	6568		
Dutch	6058	Javanese	5669	Oromo (Afan)	6159				

70 Display Settings

You can adjust TV Mode, Angle Icon, and Automatic Power Off in the Display menu.

- Before you begin, press **SELECT** to put the TV/VCR/DVD in **DVD** mode.

- 1 When play is stopped, press **SETUP** twice. The **QUICK SETUP** screen will appear.

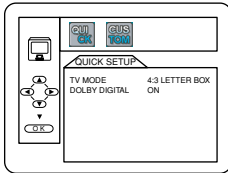

- 2 Press **▶** to select **CUSTOM** at the top of the menu, then press **ENTER**.

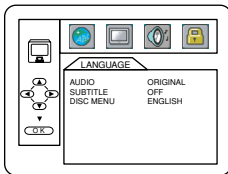

- 3 Press **▶** to select **DISPLAY**, then press **ENTER**.

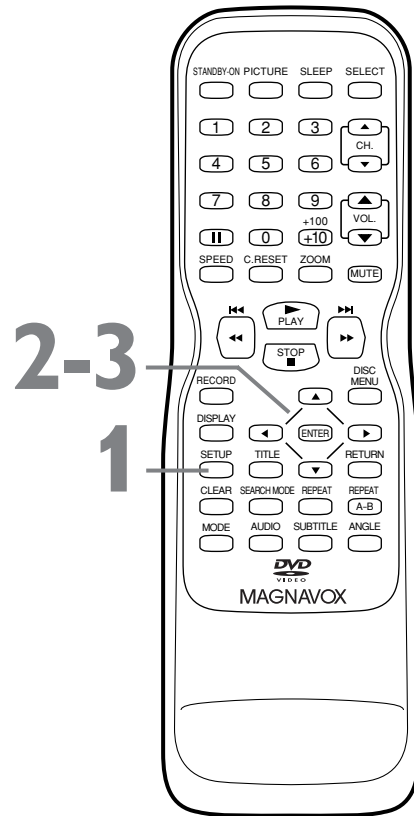
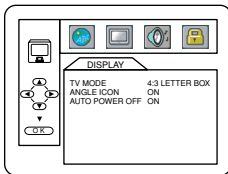

Helpful Hints

- Selecting a different TV MODE setting is only effective if it is available on the DVD. Check the DVD Disc menu or case for details.
- You also can adjust TV MODE in the QUICK SETUP menu. With QUICK selected, press ENTER. TV MODE will be selected, so press ENTER. Press ▲ or ▼ to choose a setting, then press ENTER. Press SETUP to remove the menu.

Display Settings (cont'd) 71

4 Press ▲ or ▼ to select an item, then press ENTER.

- If you selected **TV MODE**, press ▲ or ▼ to select a setting, then press ENTER.

Choose 4:3 LETTER BOX if you want to see the entire, widened picture with black bars at the top and bottom of the screen. This looks like the picture you see when watching movies in a theater. This setting is possible only if the DVD was recorded in the letter-box or widescreen format.

Choose 4:3 PAN & SCAN for a full height picture, with both sides trimmed. Some companies refer to this as reformatting the picture to fit your TV screen and may call it the regular or normal format.

- If you selected **ANGLE ICON**, press ENTER repeatedly to turn ANGLE ICON ON or OFF. The default setting is ON. Choose ON to see the Angle icon when multiple camera angles are available during DVD play. *Details are on page 58.* Choose OFF to disable the Angle icon.

- If you selected **AUTO POWER OFF**, press ENTER repeatedly to set AUTO POWER OFF to ON or OFF. The default setting is ON. Choose ON if you want the TV/VCR/DVD to turn off when there is no activity in DVD mode for 20 minutes.

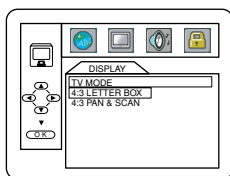
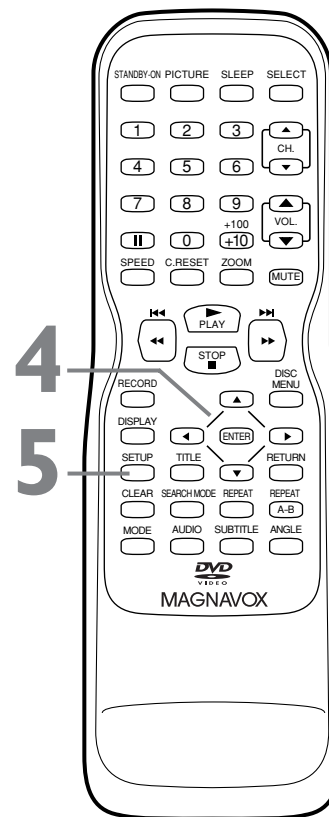

TV MODE

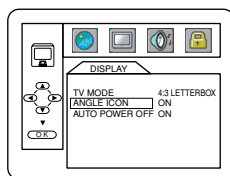

ANGLE ICON

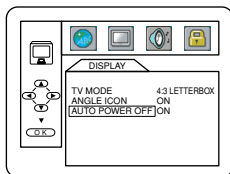

AUTO POWER OFF

5 Press SETUP to exit the menus.

72 Audio Settings

Change Audio settings based on other equipment you connected to the TV/VCR/DVD or according to your Disc sound features.

- Before you begin, press **SELECT** to put the TV/VCR/DVD in DVD mode.

- 1 While play is stopped, press **SETUP** twice. The QUICK SETUP screen will appear.

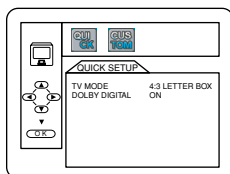

- 2 Press **▶** to select **CUSTOM** at the top of the menu, then press **ENTER**.

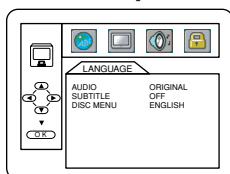

- 3 Press **▶** to select **AUDIO** (), then press **ENTER**.

- 4 Press **▲** or **▼** to select **DRC**, **DOLBY DIGITAL**, or **DOWN SAMPLING**, then follow step 5 accordingly.

- 5
 - If you selected **DRC**, press **ENTER** repeatedly to turn Dynamic Range Control (DRC) **ON** or **OFF**. Choosing **ON** compresses the range of volume by suppressing loud sounds and raising low sounds.
 - If you selected **DOLBY DIGITAL**, press **ENTER** repeatedly to select **ON** or **OFF**. Select **ON** if you used the **COAXIAL DIGITAL AUDIO OUT** jack to connect the TV/VCR/DVD to a stereo that is Dolby Digital compatible. Details are on page 10. Otherwise, choose **OFF**.
 - If you selected **DOWN SAMPLING**, press **ENTER** repeatedly to choose **ON** or **OFF**. Choose **ON** to set downsampling to 48 kHz. Choose **OFF** to set downsampling to 96 kHz.

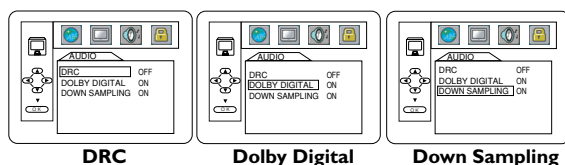

- 6 Press **SETUP** to exit the menu.

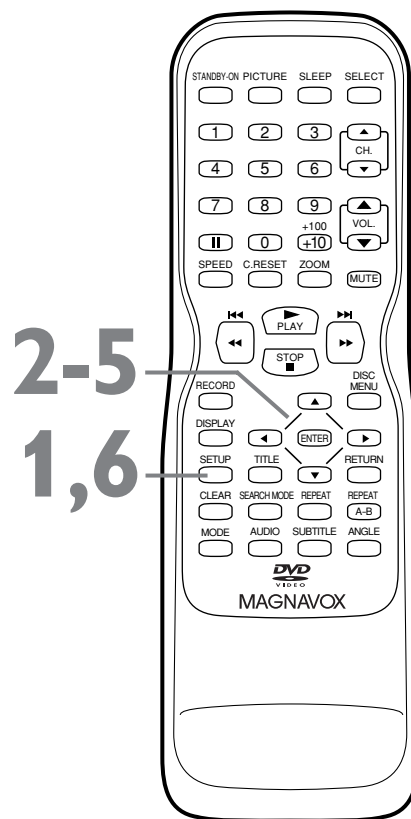

Helpful Hints

- Dolby Digital sound must be available on the DVD.
- You can adjust **DOLBY DIGITAL** in the **QUICK SETUP** menu. With **QUICK** selected, press **ENTER**. Press **▼** to select **DOLBY DIGITAL**. Press **ENTER** to choose **ON** or **OFF**. Press **SETUP** to remove the menu.
- When you play a Disc that has copyright protection, downsampling will be at 48 kHz, even if **DOWN SAMPLING** is **OFF**.

On-Screen Displays 73

DVD Display

1 Press **DISPLAY** repeatedly to see the following displays during DVD play.

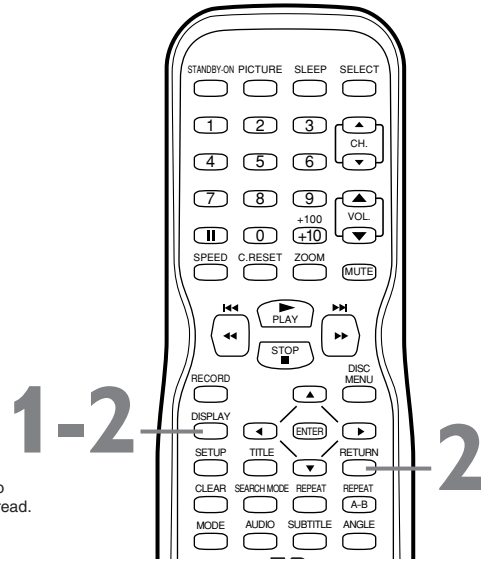
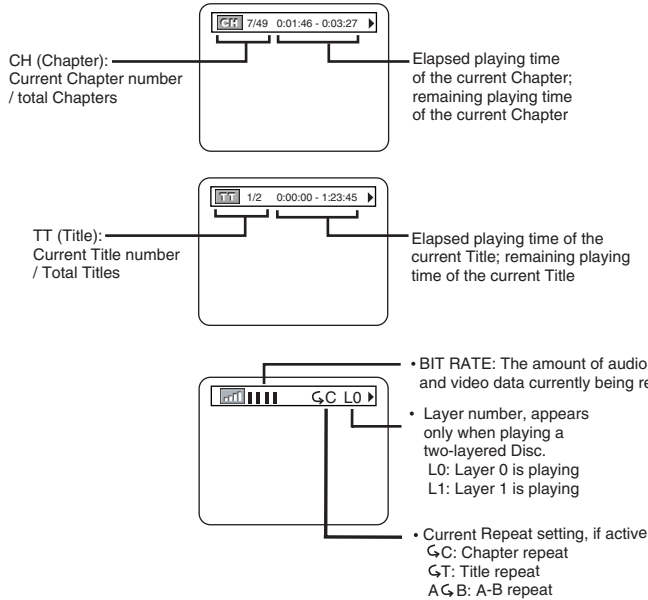

2 Press **DISPLAY** repeatedly or press **RETURN** to remove the display.

Audio CD Display

1 Press **DISPLAY** repeatedly to see the following displays during Audio CD play.

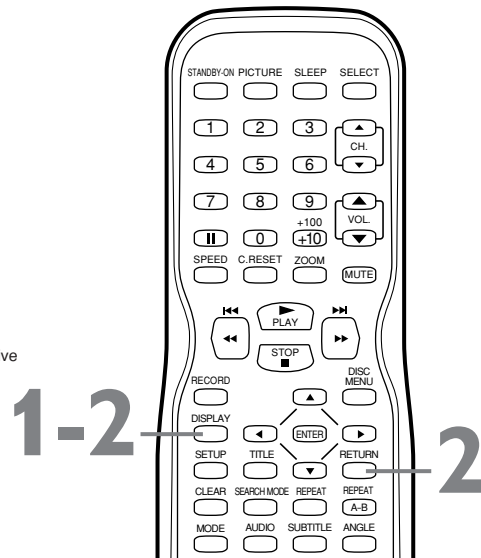
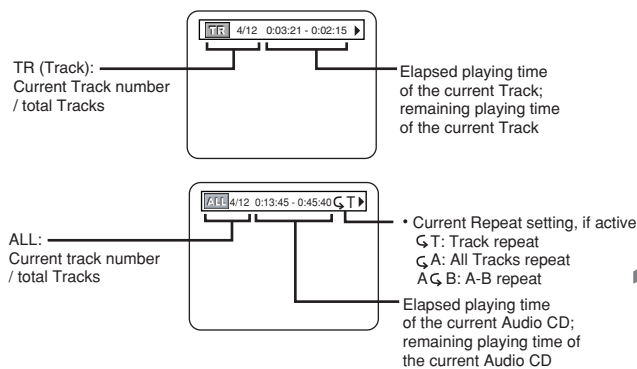

2 Press **DISPLAY** repeatedly or press **RETURN** to remove the display.

74 Black Level, Virtual Surround

Black Level

Adjust Black Level to brighten the DVD picture.

- 1 During DVD play, press **MODE** so the Black Level icon shows in the top left corner of the TV screen.



- 2 Within 10 seconds, press **ENTER** to choose **ON** or **OFF**. **ON** brightens the dark parts of the picture. **OFF** shows the original picture as recorded.

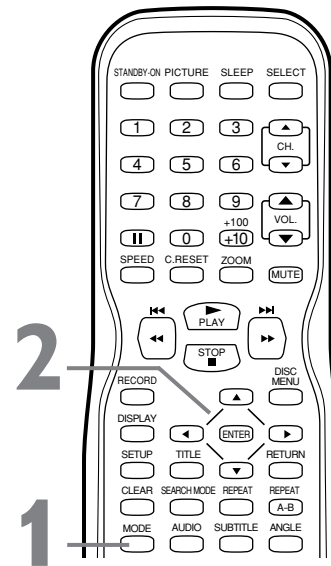

Virtual Surround

You can enjoy improved stereo sound when you play DVDs, Audio CDs, or MP3 files recorded in Dolby Digital or Pulse Code Modulation (PCM). Check the Disc case for details on availability.

- 1 During Disc play, press **MODE** so the Virtual Surround icon appears in the top left corner of the TV screen.

- 2 While the Virtual Surround icon appears, press **ENTER** to choose **1**, **2**, or **OFF**. The default setting is **OFF**. The icon will disappear after about 10 seconds.

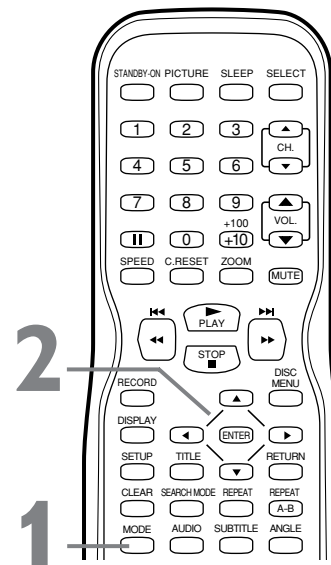

Helpful Hint

- Virtual Surround is available only if you set Stereo Sound to Stereo. Details are on page 64.

Glossary 75

AUDIO In Jacks: red and white jacks on the front of the TV/VCR/DVD which are used to receive or record audio from another source (VCR, Camcorder, etc.).

Automatic Channel Setup: process in which the TV/VCR/DVD memorizes all available TV channels. Then, when you push the CH. ▲/▼ buttons, you only scan through channels you receive.

Auxiliary (AUX): The channel to which you set your TV/VCR/DVD during dubbing or when viewing material that is playing on another device that is connected to the TV/VCR/DVD (for example, a Camcorder or VCR or TV channels from a Cable Box/Satellite Receiver). Press SELECT to choose AUX at the TV/VCR/DVD.

Bands: settings that allow you to tune channels.

- **Antenna** – VHF (very high frequency; channels 2-13) and UHF (ultra high frequency; channels 14-69).
- **Cable** – standard channels can be received without a Cable Box.

Brightness: adjusting increases or decreases the brightness of the color on the screen.

COAXIAL Digital Audio Out jack: Sends digital audio to a stereo, allowing you to adjust the volume at the stereo.

Color: adjusting pales or brightens the TV/VCR/DVD picture color.

Dolby Digital: A surround sound system that provides 5.1 channel sound as used in movie theaters. Sound is heard through multiple channels, not just the right and left as with standard stereo.

Dubbing: copying a videotape from a separate VCR or camcorder.

HQ: high quality; a feature in the VCR circuitry which provides enhanced videotape picture detail through the TV/VCR/DVD.

OTR: One-Touch Recording; a timed recording that starts immediately and records for 30 minutes to eight hours, whichever you specify.

Sharpness: adjusting softens or clarifies the picture on the screen.

Tape Speeds: how fast the videotape travels during playback or recording. The faster the tape speed, the better the recording quality will be. Faster speeds (SP) also use more space on the tape. So, you can put more recording on a tape if you use a slower tape speed (SLP).

- **SP** (standard play) – fastest tape speed (recording time for a T120 tape is approximately two hours); best picture quality.
- **LP** (long play) – average tape speed; only playback in this speed is available on this TV/VCR/DVD.
- **SLP** (super long play) – slowest tape speed (recording time for a T120 tape is approximately six hours).

Tint: adjusting changes the tints of the picture from purple to green.

VIDEO In Jack: yellow jack on the front of the TV/VCR/DVD which is used to receive or record video from another source (VCR, Camcorder, etc.).

76 Helpful Hints

If you are having problems with your product, check this list of problems and possible solutions before requesting service. You may be able to solve the problem yourself.

Location

For safe operation and satisfactory performance of your TV/VCR/DVD, remember the following:

- Shield it from direct sunlight and keep it away from sources of intense heat.
- Avoid dusty or humid places.
- Avoid places with insufficient ventilation. Do not block the ventilation openings at the top and bottom of the TV/VCR/DVD. Do not place the TV/VCR/DVD on a carpet, as this will block the ventilation openings.
- Avoid locations subject to strong vibrations.
- Do not place the TV/VCR/DVD near strong magnetic fields.
- Do not move the TV/VCR/DVD from a cold place to a hot place, or vice versa.

Electrical Shock and Fire Hazards

- Do not handle the power cord with wet hands.
- Do not pull the power cord when disconnecting the TV/VCR/DVD from the AC (alternating current) wall outlet. Grasp it by the plug.
- If you spill water on the TV/VCR/DVD, unplug the power cord immediately and take the TV/VCR/DVD to an authorized service center.
- Do not put your fingers or objects into the cassette compartment or disc tray.
- Do not place anything on top of the TV/VCR/DVD.

Dew Warning (Moisture Condensation)

- Moisture may condense inside the unit when you move it from a cold place to a warm place, after heating a cold room, or when the humidity is high. There is no warning that moisture is in your TV/VCR/DVD. Playing a tape when moisture has accumulated could damage the tape and the TV/VCR/DVD. If you suspect moisture inside the TV/VCR/DVD, keep the power on (but do not play a tape) for at least two hours. This will allow the TV/VCR/DVD to dry.

TV/VCR/DVD will not perform a timer recording.

- Set the recording start and stop times correctly. *Details are on pages 28-31.* Midnight is 12 a.m. Noon is 12 p.m.
- Make sure the TV/VCR/DVD power is off for the timer recording.
- Set the clock. *Details are on pages 20-23.*
- Put a videotape in the cassette compartment of the TV/VCR/DVD. The tape must have a record tab. *Details are on page seven.*
- If the power fails, timer recordings will be restored when you reset the clock. Timer recordings do not occur if set to take place during the power failure.

TV/VCR/DVD will not record on a videotape.

- Make sure the videotape has a record tab. *Details are on page seven.*
- Plug the power cord into an active AC outlet. *Details are on page nine.*
- Check your hookups. *Details are on pages eight-nine.*
- Set up the TV channels. *Details are on page 18.*
- You cannot record DVDs onto a videotape using the TV/VCR/DVD.

Channel reception is poor.

- Check connections, then set up the channels again. *Details are on page 18.*

TV/VCR/DVD has no power.

- Connect the power plug to an AC (alternating current) outlet completely.

TV/VCR/DVD ejects the tape when you try to start a recording.

- Make sure the tape has a record tab. *Details are on page seven.*

Helpful Hints (cont'd) 77

Disc cannot play.

- Insert a playable Disc. Make sure the Disc is labelled for Region 1 or ALL regions and is NTSC compatible. *Details are on page six.*
- Place the Disc correctly in the Disc tray. If the Disc is one-sided, place the Disc in the tray with the label facing up. If the Disc is two-sided, make sure the label of the side you want to play is facing up.
- Clean the Disc. Make sure the Disc is not scratched or warped.
- Cancel the Parental Controls, enter the password, or change the Parental level. *Details are on pages 60-63.*

TV/VCR/DVD does not have a picture.

- Adjust the antenna or check the Cable TV or satellite signal connection. If using a Cable Box/Satellite Receiver, set the TV/VCR/DVD to channel 3, 4, or AUX. *Details are on pages eight-nine.*
- Adjust the picture controls. *Details are on page 25.*
- Select an active TV channel. *Details are on pages 18-19.*
- Make sure the Disc is compatible with the DVD Player of the TV/VCR/DVD. *Details are on page six.*

TV/VCR/DVD has poor sound or no sound.

- Press VOL. ▲/▼ to adjust the volume. Press MUTE to restore the volume.
- Check the audio settings for DVD mode. *Details are on page 72.*
- Check the audio settings of the Disc. For example, you may have selected "soundtrack" playback or an unavailable sound setting (such as Dolby Digital) or language. *Details are on pages 64, 68-69, and 72.* Try other sound options provided in the DVD Disc menu.

You cannot choose a DVD feature, such as camera angle or audio or subtitle language.

- The feature must be recorded on the DVD. Not all DVDs contain multiple angles, subtitles, etc. Refer to the Disc case to see what features are available. If the feature is not available, the "X" may appear in the top right corner of the screen.

Videotape play is poor or the tape is destroyed.

- Adjust the tracking. *Details are on page 40.*
- Use the Rental feature. *Details are on page 35.*
- If moisture has accumulated in the unit, keep the power on for at least two hours, but do not play a tape.

TV/VCR/DVD does not display closed captions for TV programs.

- Make sure closed captioning is available for the program. Refer to the TV listings in your local newspaper.

Remote control does not operate the TV/VCR/DVD.

- Aim the remote control directly at the remote sensor on the front of the TV/VCR/DVD. *Details are on page 16.*
- Remove all obstacles between the remote control and the TV/VCR/DVD.
- Inspect and replace the batteries in the remote control. *Details are on page seven.*

Number buttons will not select channels above 69.

- Enter channel numbers as a two-digit number. If you want to select channels 100 and above, press the +100/+10 button, then the Number buttons for the last two digits. *Details are on page 11.*
- If you are using an antenna and do not have Cable TV/Satellite, only channels 2-69 will be available.

You cannot insert a tape into the cassette compartment of the TV/VCR/DVD.

- Insert the tape with the window facing up and the record tab facing you and on the left.
- Make sure a tape isn't already inside by pressing STOP/EJECT ■▲ on the front of the TV/VCR/DVD.
- Gently push on the center of the tape. Never force a tape into the TV/VCR/DVD.
- If you have set a timer recording and the power is off, the unit will eject the tape if the record tab is missing.

You cannot remove the tape from the TV/VCR/DVD.

- Make sure the power plug is completely connected to an AC (alternating current) outlet.
- If a timer recording is programmed, turn on the TV/VCR/DVD power, then eject the tape. Be sure to insert a tape and turn off the TV/VCR/DVD power for the timer recording.
- Unplug the TV/VCR/DVD power cord for five minutes. Then, plug in the power cord again, then press STANDBY-ON on the TV/VCR/DVD. If the tape does not eject, press STOP/EJECT ■▲ on the TV/VCR/DVD three to five times. If the tape still does not eject, an authorized servicer may need to remove the tape.

78 Specifications

General TV/VCR

CRT:	
19MDTR20:	19 inch in-line gun, 90° deflection tube
27MDTR20:	27 inch in-line gun, 110° deflection tube
Closed Caption system:	§15.119/FCC
Video Heads:	Rotary four-head
Tape width:	1/2 inch
Tape speeds	
SP	33.40 mm/sec.
LP	16.67 mm/sec.
SLP	11.12 mm/sec.
Tuner channels:	2-69
Cable TV:	1-125

General DVD

Color System:	NTSC
Frequency response:	
DVD (linear sound)	20 Hz to 22 kHz (sample rate: 48 kHz)
	20 Hz to 44 kHz (sample rate: 96 kHz)
Audio CD	20 Hz to 20 kHz
Signal-to-noise ratio:	
Audio CD	100 dB (EIAJ)
Dynamic range:	
DVD (linear sound):	85 dB
Audio CD:	84 dB (EIAJ)
Total distortion factor	
Audio CD:	0.07% (EIAJ)
Wow and flutter:	Below the measurement limitation (+/-0.001% W PEAK) (EIAJ)

Electrical Specifications

Sound output: Two speakers, 1W, 8 ohm

Other Specifications

Terminals	
Antenna In:	VHF/UHF/Cable TV 75 ohm unbalanced (F-type)
Video In:	One RCA connector
Audio L/R In:	Two RCA connectors
Headphone:	1/8" stereo (3.5 mm)
Coaxial Digital	
Audio Out:	One pin jack, 500m Vpp (75 ohm)
Audio L/R Out:	Two RCA connectors
Operating temperature:	41°F-104°F (5°C-40°C)

Power requirements: AC 120V, 60Hz

19MDTR20:

Power consumption (Maximum):	90W
Dimensions:	Height: 19-11/16" (500 mm) Width: 23-13/16" (605 mm) Depth: 18-11/16" (474 mm)
Weight:	48.5 lbs (22 kg)

27MDTR20:

Power consumption (Maximum):	125W
Dimensions:	Height: 25-1/2" (648 mm) Width: 26-9/16" (675 mm) Depth: 19-11/16" (500 mm)
Weight:	86 lbs (39 kg)

Accessories: Remote Control with two AA batteries
Owner's Manual

Designs and specifications are subject to change without notice and without our legal obligation.

Limited Warranty 79

TV/VCR/DVD COMBINATION

90 Days Free Labor/One Year Parts Exchange

The 27MDTR20 can be repaired in-home.

The 19MDTR20 should be carried in for repair.

WHO IS COVERED?

You must have proof of purchase to receive warranty service. A sales receipt or other document showing that you purchased the product is considered proof of purchase.

WHAT IS COVERED?

Warranty coverage begins the day you buy your product. For 90 days thereafter, all parts will be repaired or replaced free, and labor is free. From 90 days to one year from the day of purchase, all parts will be repaired or replaced free, but you pay for all labor charges. After one year from the day of purchase, you pay for the replacement or repair of all parts, and for all labor charges.

All parts, including repaired and replaced parts, are covered only for the original warranty period. When the warranty on the product expires, the warranty on all replaced and repaired parts also expires.

WHAT IS EXCLUDED?

Your warranty does not cover:

- labor charges for installation or setup of the product, adjustment of customer controls on the product, and installation or repair of antenna systems outside of the product.
- product repair and/or part replacement because of misuse, accident, unauthorized repair or other cause not within the control of Magnavox.
- reception problems caused by signal conditions or cable or antenna systems outside the unit.
- a product that requires modification or adaptation to enable it to operate in any country other than the country for which it was designed, manufactured, approved and/or authorized, or repair of products damaged by these modifications.
- incidental or consequential damages resulting from the product. (Some states do not allow the exclusion of incidental or consequential damages, so the above exclusion may not apply to you. This includes, but is not limited to, prerecorded material, whether copyrighted or not copyrighted.)
- damage caused by the use of non-VHS tapes or tapes that have not been tested and labeled for use in two, four, six, and eight hour VHS recorders.
- a product that is used for commercial or institutional purposes.

WHERE IS SERVICE AVAILABLE?

Warranty service is available in all countries where the product is officially distributed by Magnavox. In countries where Magnavox does not distribute the product, the local Magnavox service organization will

attempt to provide service (although there may be a delay if the appropriate spare parts and technical manual(s) are not readily available).

MAKE SURE YOU KEEP..

Please keep your sales receipt or other document showing proof of purchase. Attach it to this owner's manual and keep both nearby. Also keep the original box and packing material in case you need to return your product.

BEFORE REQUESTING SERVICE...

Please check your owner's manual before requesting service. Adjustments of the controls discussed there may save you a service call.

TO GET WARRANTY SERVICE IN U.S.A., PUERTO RICO, OR U.S. VIRGIN ISLANDS...

Take the product to a Magnavox factory service center (see enclosed list) or authorized service center for repair. When the product has been repaired, you must pick up the unit at the center. Centers may keep defective parts.

(In U.S.A., Puerto Rico, and U.S. Virgin Islands, all implied warranties, including implied warranties of merchantability and fitness for a particular purpose, are limited in duration to the duration of this express warranty. But, because some states do not allow limitations on how long an implied warranty may last, this limitation may not apply to you.)

TO GET WARRANTY SERVICE IN CANADA...

Please contact Magnavox at:
1-800-705-2000.

(In Canada, this warranty is given in lieu of all other warranties. No other warranties are expressed or implied, including any implied warranties of merchantability or fitness for a particular purpose. Magnavox is not liable under any circumstances for any direct, indirect, special, incidental or consequential damages, howsoever incurred, even if notified of the possibility of such damages.)

REMEMBER...

Please record below the model and serial numbers found on the product. Also, please fill out and mail your warranty registration card promptly. It will be easier for us to notify you if necessary.

MODEL # _____
SERIAL # _____

This warranty gives you specific legal rights. You may have other rights which vary from state to state.

Magnavox, P.O. Box 520890, Miami, FL 33152 (402) 536-4171

EL6556E001 / 03-03

80 Index

- a-b repeat56
 angle button15, 58
 ant(enna) jack8-9, 17
 arrow buttons14
 audio button15, 64
 audio cd6, 54
 audio in/out jacks9-10, 16-17, 33
 audio settings (dvd)72
 auto return32
 automatic rewind, eject40
 auxiliary mode (aux)8-9, 11, 33
- batteries7
 black level74
 brightness25
- c.reset button15, 31, 36
 camera angle58
 cassette compartment16
 channel
 above 10014
 adding/deleting19
 setup18
 ▲/▼ buttons11, 15-16, 40
 chapters53
 clear button15
 clock setting20-23
 closed captions41
 coaxial digital audio out jack10, 17
 color25
 connections8-10, 33
 contents, table of4
 contrast25
 controls
 remote14-15
 tv/vcr/dvd16
 copyright protection3, 33
 counter25, 36
- daylight-savings time24
 disc menu button15, 51
 disc tray13, 16
 display button14, 25, 73
 display settings70-71
 duplication33
 dvd light16
 dvd video6
- ejecting a tape77
 enter button15
- fast forward search39, 52
 front panel16
- glossary75
- headphone jack16
- helpful hints76-77
 hookups8-10, 33
- language (dvd)64, 68-69
 language (setup menus)18
 language settings68-69
 lp (long play)26, 75
- menus5, 18, 51
 mode button15, 65, 74
 mp3 display67
 mp3 playback66
 mp3 track selection66
 mts system48-50
 mute button15
- number buttons14
- on-screen status displays25, 73
 one-touch recording27
 open/close button ▲16
 output button16
- parental controls60-63
 password60-61
 (pause) ■■ button14, 39, 55, 59
 picture controls25
 picture button14, 25
 play ► button12-14, 16
 playing discs13
 playing videotapes12
 power cord9, 17
 programs65
- random playback65
 ratings
 mpaa46
 tv42-45
 real-time tape counter36
 rear panel17
 record button14, 26
 recording
 basic26
 one-touch27
 timer28-31
 rec/otr button16, 27
 rec/otr light16
 remote control
 buttons14-15
 using7
 remote sensor16
 repeat button14, 56
 repeat a-b button15, 56
 repeat play34, 56
 rerecording33
 resuming play55
 return button14
- reverse searching39, 52
 rf coaxial cable8
- safety precautions3
 search mode button15, 53-54, 57
 searching39, 52
 second audio program48, 50
 select button14
 setup button5, 15
 sharpness25
 sleep button14, 36
 sleep timer36
 slow motion39, 59
 slp (super long play)26, 75
 sp (standard play)26, 75
 specifications78
 speed button15, 26
 standby-on button14, 16
 status display25, 73
 stereo broadcast recording48-50
 still picture39, 55
 stop ■ button14
 stop/eject ■▲ button12, 16
 subtitle button15, 58
 super high speed searching39
- table of contents4
 tape duplication33
 tape eject16, 77
 tape speed26, 75
 time search37
 time setting20-23
 timer recording
 cancelling31
 checking31
 setting28-30
 tint25
 title button14, 51
 titles51
 tracking40
 tracks54
- vcr/tv light16
 v-chip setup42-47
 video in/out jacks9, 16-17, 33
 virtual surround74
 volume ▲/▼ buttons15-16
- warranty79
- zero return36
 zoom button15, 59



This owner's manual is made of recycled paper.

IB8433E001
 Printed In Malaysia
 OEMN02212 / TD857UH / TD957UH *****

Free Manuals Download Website

<http://myh66.com>

<http://usermanuals.us>

<http://www.somanuals.com>

<http://www.4manuals.cc>

<http://www.manual-lib.com>

<http://www.404manual.com>

<http://www.luxmanual.com>

<http://aubethermostatmanual.com>

Golf course search by state

<http://golfingnear.com>

Email search by domain

<http://emailbydomain.com>

Auto manuals search

<http://auto.somanuals.com>

TV manuals search

<http://tv.somanuals.com>