

FRONT LOADING



Dryer MJ9250D / 17-2013

Owner's Manual

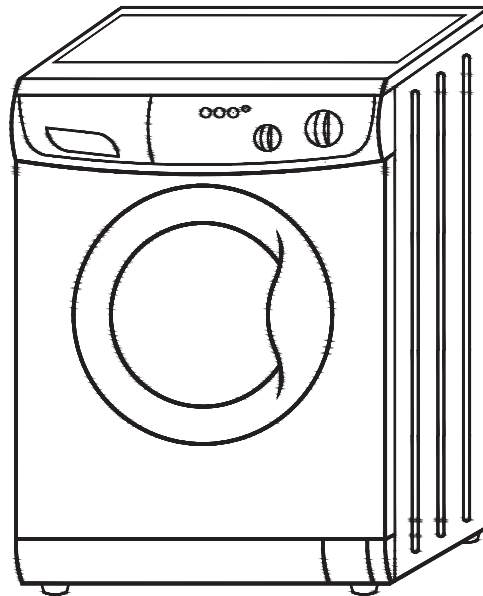



TABLE OF CONTENTS

Warranty.....	2-4
Introduction	5
Important Safety Instructions	6
Picture of the Dryer	8
Installation.....	9-10
Control Panel	11
Operating Instructions	12
How to dry	13
Maintenance	14
Technical Data	14
Troubleshooting.	15
Company Information	16

**Please read the Owner's Manual carefully before using your
new Pinnacle by Majestic Dryer**



WARRANTY INFORMATION

Your Pinnacle® by Majestic appliance is protected by this warranty under normal, personal, family or household use (1 Year), and limited commercial use (90 days) in the USA and Canada.

WARRANTY

Your Majestic™ Appliance is covered by this limited warranty on its mechanical parts under normal personal, family, household or RV use in the US and Canada.

For one year from the date of purchase, when the Majestic™ Appliance is installed, operated and maintained according to the instructions attached or furnished with the product, Manufacturers Supply, Inc. (hereinafter MSI) will pay for replacement parts or repair the defective parts, at MSI's option, and labor to correct defects in materials or workmanship when the appliance is used under normal personal, family, household or RV use in the US and Canada. A MSI designated service company must provide Service. This limited warranty applies to the original purchaser only. THIS LIMITED WARRANTY DOES NOT COVER: incidental or consequential damages or damages resulting from external causes such as abuse, misuse, incorrect voltage or acts of God. This limited warranty does not cover service calls, which do not involve defects in mechanical parts or workmanship. Incorrect installation procedures or materials not provided by Majestic™ Appliance are not covered. Therefore, service calls, diagnosis, and repair costs for a service call, which does not involve defective workmanship or mechanical parts, will be the responsibility of the consumer/owner (i.e., improper hookup or leveling, cleaning of air and/or water filters, replacing broken door handles, or excessive movement caused by travel or recreation or installation). In these instances our flat rate schedule for labor expenses applies.

THE WARRANTY DESCRIBE IN THE PRECEDING PARAGRAPH SHALL BE IN LIEU OF ANY OTHER WARRANTY, EXPRESS OR IMPLIED, INCLUDING BUT NOT LIMITED TO ANY IMPLIED WARRANTY OF MERCHANTABILITY OR FITNESS FOR A PARTICULAR PURPOSE.

WARRANTY REGISTRATION AND PROOF OF PURCHASE ARE REQUESTED

Geographic Exception: If the product is installed at a location more than 50 miles from an urban area (minimum population 25,000), Majestic Appliances may, at its option, offer a 2-year parts only Warranty, if a service agent cannot be found. Responsibility for labor, in such instances will be that of the consumer-owner. Majestic Appliances will, however provide free technical assistance for repairs.



EXCLUSIONS

In no event shall Majestic Appliances be liable for incidental or consequential damages or for damages resulting from external causes such as abuse, misuse, incorrect voltage or acts of God. This warranty does not cover service calls, which do not involve defective workmanship or materials covered by this warranty. Accordingly, diagnosis and repair costs for a service call, which does not involve defective workmanship or materials, will be the responsibility of the consumer-owner.

Specifically, the following work is not covered under warranty and does not constitute warranty work:

- **Installation – e.g. improper hook-up or leveling or non-removal of shipping bolts**
- **Maintenance – e.g. cleaning of lint filter**
- **Damage – e.g. replacing broken door handle**

Most work is covered. The defining factor is, has the machine malfunctioned (Majestic is responsible) or has the customer omitted or done something to cause machine to malfunction (customer is responsible). Some States do not allow the exclusion or limitation of incidental or consequential damages, so the above limitation or exclusion may not apply to you.



WARRANTY SERVICE

This warranty is given by:

Majestic Appliances
2801 W Sam Houston Pkwy N, Suite 195
Houston, TX 77043-1611

Service under this warranty must be obtained by the following steps, in order:

Call a Majestic Appliances Authorized Service Agent (obtain number of nearest agent from your dealer or by calling Majestic Service at 1-800-678-8002). Under normal circumstances, Service will be provided during regular business hours (9:00 a.m. to 5:00 p.m. weekdays).

GENERAL

Since it is responsibility of the consumer-owner to establish the warranty period by verifying the original purchase date, Majestic Appliances recommends that a receipt, delivery slip or some other appropriate payment record be kept for that purpose. Remember to send in your Warranty Registration Card so that a proof of your purchase exists with Majestic Appliances. You can also register online or by calling Majestic Appliances Customer Service at 1-866-218-6902. This warranty gives you specific legal rights, and you may also have other rights, which vary from State to State.

Corporate Office

Majestic Appliances
2801 W Sam Houston Pkwy N, Suite 195
Houston, TX 77043-1611
Phone (713) 933-1462
Fax (832) 202-2732
Toll Free: (866) 218-6902



European Testing Laboratories

US N°3094367 CANADA

The ETL Listed Mark is the legal equivalent to the UL and CSA Listed Marks

PINNACLE by MAJESTIC CONTACTS

Website:	www.majesticappliances.com
Service:	1-866-218-6902/ service@majesticpinnacle.com
Parts & Accessories:	parts@majesticpinnacle.com
Technical Support:	tech@majesticpinnacle.com



INTRODUCTION

Congratulations on your new Pinnacle by Majestic Vented Tumble Dryer. In addition to its unique design, this is a highly sophisticated product that will give you many years of satisfaction. Please take the time to read this Owner's Manual in order to understand the machine and get the best use out of your valuable purchase.

Here are some of the best reasons for buying your Pinnacle Dryer:

1. Energy Savings

This appliance is engineered to provide valuable energy savings when compared to other dryers.

2. Space Savings

The Dryer is designed to utilize horizontal and vertical space effectively. By using the stacking kit (available separately) this unit can be mounted onto the Pinnacle by Majestic Combo Washer-Dryer or the Pinnacle by Majestic Washer.

3. Temperature Selection

Choose your drying temperature for the quantity and quality of clothes you place in the dryer. High and low heat settings are available for cottons/mixed thread clothing and for delicates.

4. Meeting Standards

The dryer vent uses a standard 4" duct that fits dryer exhaust.

5. Convenient Lint Control

This unit does not use a lint filter and no cleaning is required after every load.

6. 110V operation

The dryer power cord plugs into a standard 110V outlet - available in most homes.

7. Safety

The dryer has a built in safety switch that reset when airflow is restricted. This lets the dryer electronics remain unharmed by pausing the appliance till the conditions are corrected.

8. Easy Operation

Just set the dryer time based on type of clothing and press the Power button. Easy as 1-2-3.



IMPORTANT SAFETY INSTRUCTIONS

Your safety and that of you children

Your machine has been built in compliance with safety regulations, to protect you and all your family.

WARNING - To reduce the risk of fire, electric shock, or injury to persons when using your appliance, follow basic precautions, including the following:

1. Read all instructions before using the appliance.
2. Do not dry articles that have been previously cleaned in, washed in, or spotted with gasoline, dry-cleaning solvents, other flammable or explosive substances, as they emit vapors that could ignite or explode.
3. Do not allow children to play on or in the appliance. Close supervision of children is necessary when the appliance is used near children.
4. Before the appliance is removed from service or discarded, remove the door.
5. Do not reach into the appliance if the tub or drum is moving.
6. Use caution as drum interior becomes hot after use.
7. Do not install or store this appliance where it will be exposed to the weather.
8. Do not tamper with controls.
9. Do not repair or replace any part of the appliance or attempt any servicing unless specifically recommended in the user-maintenance instructions or in published user-repair instructions that you understand and have skills to carry out.
10. Do not use fabric softeners or products to reduce static unless recommended by the manufacturers of the fabric softener product.
11. Do not use heat to dry articles containing foam rubber or similarly textured rubber-like materials.
12. For vented dryers keep the exhaust opening and surrounding areas free from accumulation of lint, dust, and dirt.
13. Do not place items exposed to cooking oils in your dryer. Item contaminated with cooking oils

SAVE THESE INSTRUCTIONS



HELPFUL HINTS

This Dryer is a 110 Volt machine, so the heating element requires more time to achieve full heat than a larger 220-volt unit requires. The heating element will take about 10 minutes to reach full heat.

To dry your laundry, the Dryer blows heated air into the rotating drum. As the drum tumbles your laundry, the warm air-dries it. If the drum is overfilled with laundry, the air is not allowed to circulate and clothes will not dry properly.

DRYER EFFICIENCY

Your dryer operates on 110 volts and the heat element is rated at 1200 watts; it will take a longer time to dry clothes than a traditional dryer (which operates on 220 volts, 5,000 watts). However, with the following tips, you can increase the efficiency of the dryer:

- 1. FABRIC SOFTENER:** Prior to putting clothes into the this unit, adding liquid fabric softener (e.g. Downey®) to the wash load will help improve the drying efficiency by at least 30%.
- 2. OVERLOADING:** The drum has a capacity of 14 lbs (3.0 cu. ft.) With too many clothes, airflow is reduced, increasing drying time. A maximum of 7.0 lbs or 3/5th of the drum full of clothes is recommended for ideal drying.



SAFETY



CAUTION

**RISK OF ELECTRIC SHOCK
DO NOT OPEN**

CAUTION: TO REDUCE THE RISK OF ELECTRIC SHOCK, DO NOT REMOVE COVER (OR BACK). NO USER SERVICABLE PARTS INSIDE. REFER SERVICING TO QUALIFIED SERVICE PROFESSIONALS.

The model number of this product may be found on the back of the unit; the serial number of the label affixed to the back of the unit.

You should note the model and serial numbers of this unit in the space provided. Retain this booklet as a permanent record of your purchase to aid in identification in the event of theft.

MODEL# _____

SERIAL# _____

INTRODUCTION

Your new appliance is carefully engineered product. Many times what appears to be a reason to call for service is a situation that may require nothing more than a simple adjustment you can easily make in your own home.

You will be charged for a service call while the appliance is in warranty if defective product workmanship or materials do not cause the problem covered by this warranty.

To avoid a charge for an unnecessary service call, and before calling a serviceman, please refer to the troubleshooting section for situations that you can remedy. This section is included on pages 15 of this Owner's Manual.

Your Dryer is front loading, with an extra large door opening for easier access.

You will obviously want to obtain the best possible dry. By reading and following the instructions in this booklet you will achieve excellent results.

Please, ensure that the instructions are followed. If you should need any further advice or assistance, please, contact the dealer where your machine was purchased, or call Majestic Customer Service at **1-800-678-8002**.

This appliance is an automatic dryer with a capacity of up to:

- DRYING 14 Lbs dry weight of clothes

PRE-INSTALLATION

1. The unit must be installed on a strong level floor, and in protected, dry, and well-ventilated area close to a power source.
2. Installation on Carpet or Wood increases vibrations.
 - Carpets - place on light carpet only.
 - Wood - brace floor with screws and place additional sheets of plywood before installation.
3. This unit's installation and grounding should be done in accordance with local codes by a qualified installer. "Installation Instructions" are included in this manual for the Installer's reference.
4. The unit should be plugged into a properly grounded three (3) prong electrical outlet of 110 V/ 60Hz with minimum 15 Amps. It should not be controlled by a wall switch or pull cord which might be turned off accidentally.

PICTURE OF THE TUMBLE DRYER

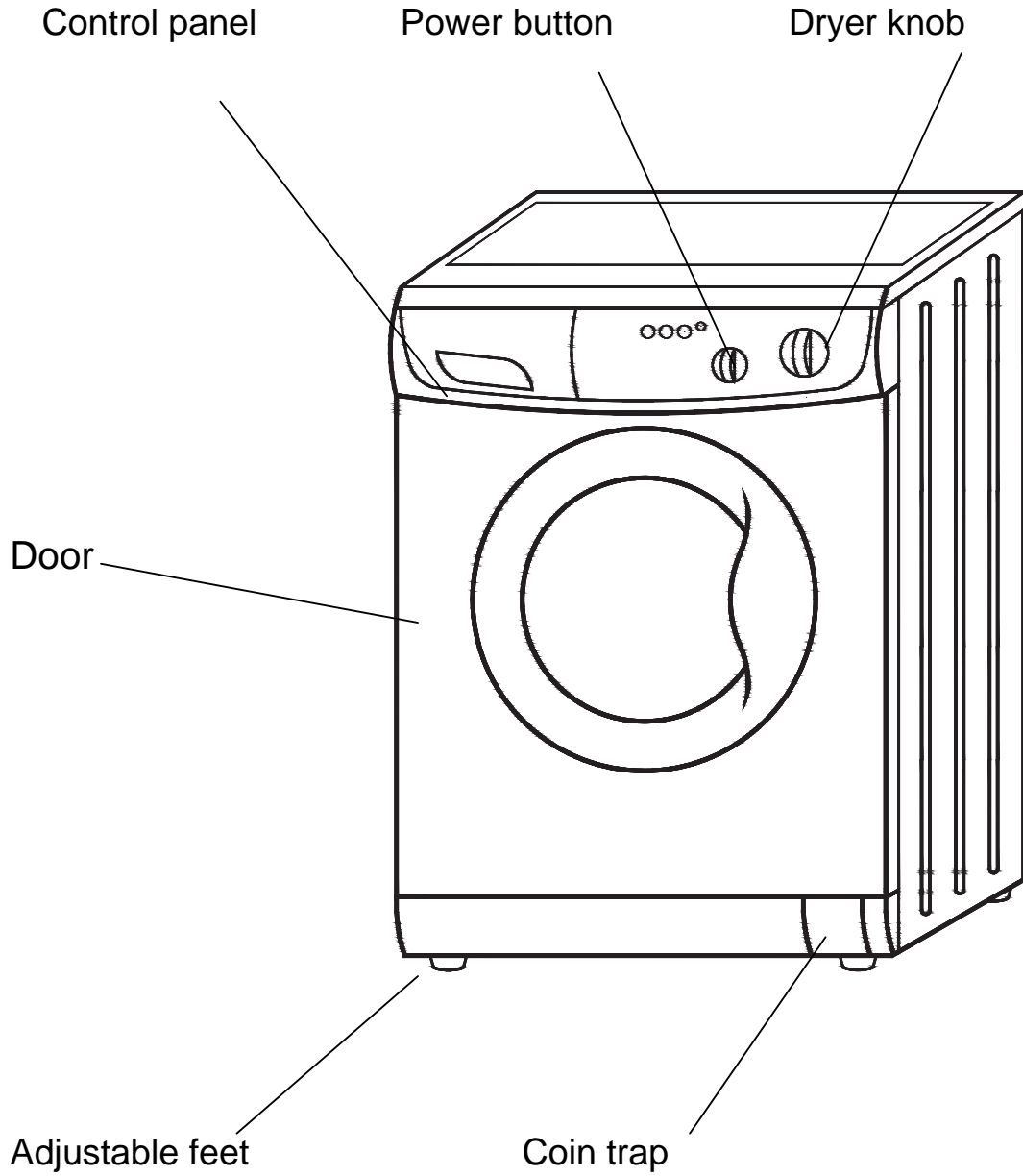

INSTALLATION

UNPACKING, LEVELING, & POSITIONING

Remove the packing and check that the dryer is undamaged. If you have any doubt, do not use the dryer and call Majestic Customer Service. Keep all packing parts (plastic bag, foam rubber, screws, etc.) out of the reach of children since they could be dangerous.

Important: The inside of the dryer consists of a free floating drum that is affixed with shipping bolts at the back of the cabinet (Fig.1) during transport. Before starting the machine, remember to remove the shipping bolts. To prevent any external pollutants from entering the machine, remember to close the holes left open by the bolts with the plastic caps provided in the packet containing the Owner's Manual.

It is important for the machine to be perfectly level. For this reason, the machine is fitted with adjustable feet used for leveling the machine before use (Fig.2).

In the case of flooring with carpeting, remember to check that there is sufficient ventilation around the machine.

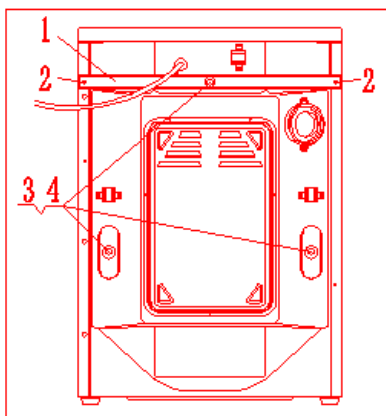

(Fig.1)

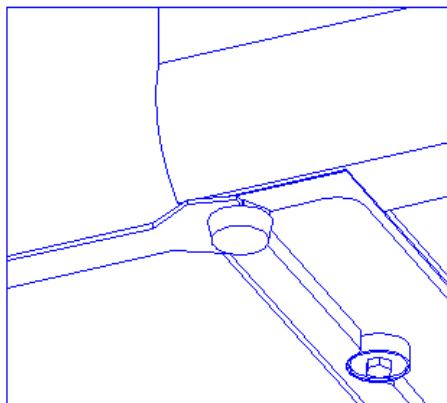

(Fig.2)

ELECTRICAL CONNECTION

Connect the plug to a power outlet – 110V/60Hz with minimum 15 Amps. Make sure that the voltage and frequency available corresponds with those stated on the serial number plate located on the back of the machine. Do not use adaptors or extension cords since they could result in overheating and burn out.

GROUNDING

This appliance must be grounded. In the event of malfunction or breakdown, grounding will reduce the risk of electric shock by providing a path of least resistance for electric current. This appliance is equipped with a power cord having an equipment-grounding conductor and a grounding plug. The plug must be plugged into an appropriate outlet that is properly installed and grounded in accordance with all local codes and ordinances.

WARNINGS

- Improper connection of the equipment-grounding conductor can result in a risk of electric shock. Check with a qualified electrician or service representative if you are in doubt as to whether the appliance is properly grounded.
- Do not modify the plug provided with the appliance: if it will not fit the outlet, have a

proper outlet installed by a qualified electrician.

Connection the vent hose

This machine vents the moist hot air out of the unit and requires a vent hose to be installed, to install the vent hose, Screw the vent hose 2 into the flange 1 (Fig.3).

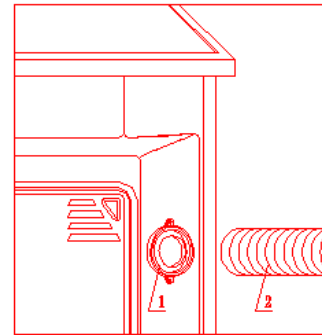

(Fig.3)

RECESSED, CLOSET AND ALCOVE INSTALLATION (Instructions)

The machine may be installed in a recessed area, closet or alcove.

The installation spacing is in inches and is the minimum acceptable.

Additional spacing should be considered for easy installation, servicing and compliance with local codes and ordinances.

Closet installation must be exhausted.

Other installations must use the minimum dimension indicated.

Additional clearances for wall, door and floor molding may be required.

Additional space is needed when an external exhaust elbow is used.

The closet's front door must be a shutter, and the clearance between the slats must be more than 1/3 area the front door.

See Fig 4,

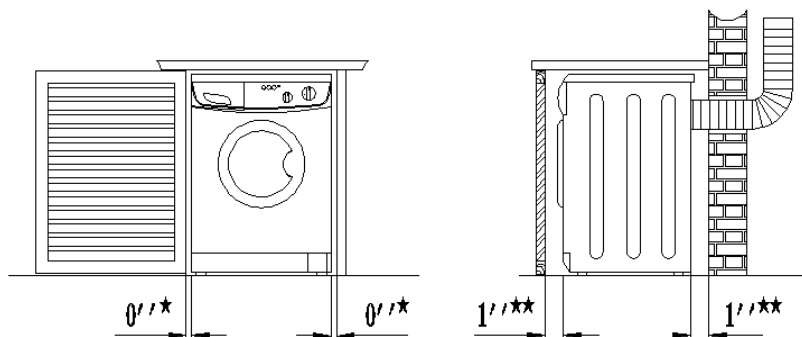

(Fig.4)

CONTROL PANEL

- A Dryer knob
- B Power button

- C Power indicator light
- D Run indicator light

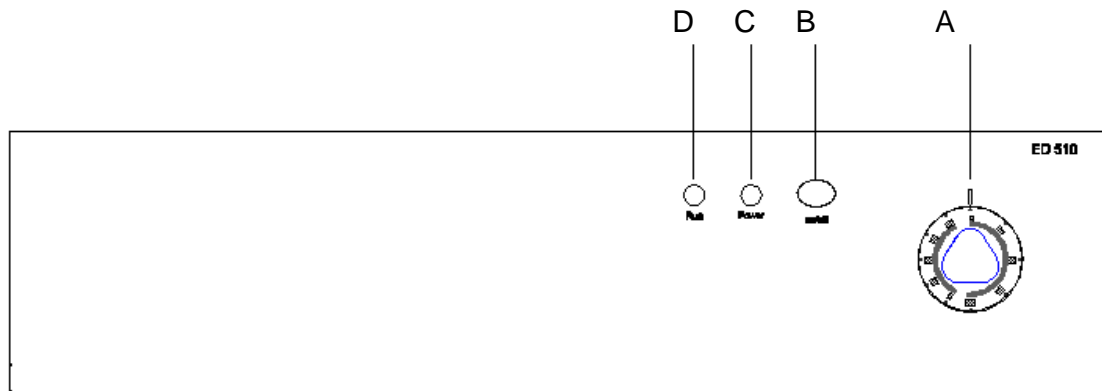

A

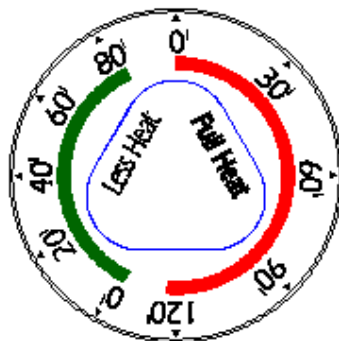

THIS DASH IS WRONG – HALF HEAT BUTTON?

Turn dryer knob to set minutes for drying.
 The left side is full heat (250° F)
 The right side is less heat (185° F).

B

Power button.

Pressed in for ON
 Not pressed for OFF

C

Power indicator light

This light indicates whether the power is on or off. The light comes on when button B is pressed and goes off when button B is not pressed.

D

Run indicator light

This light indicates whether the dryer is on or off.



Warning — to reduce the risk of fire, electric shock, or injury to person, read the **IMPORTANT SAFETY INSTRUCTIONS** before operating this appliance.

OPERATING INSTRUCTIONS

1. Make sure Dryer is turned off. (Indicator light should be off).
2. Separate clothes into cottons, permanent press.
3. Load clothes of the selected type loosely into the drum. Do not load clothes more than 3/5th full.
4. Close the Dryer door. You will hear a click when it is correctly closed.
5. Turn the Dryer knob to the desired amount of minutes for drying. High Heat for Cottons and Less Heat for Perma Press clothing.
6. Review these steps and check all the settings on the control panel before starting the machine.
7. Press the Power button. The indicator light will come on and in a few seconds, you will hear the cycle begin.
8. When the Dryer has completed the cycle, the machine will stop automatically, although the indicator light will remain on until you manually press out the Power button.

Note:

You can open the door any time during the Dry cycle without waiting. Be aware if heat builds up.

STARTING THE DRYER

Starting your dryer in the right way is important for the quality of your dry, to help prevent future problems and enhance life expectancy of your appliance. Once you have loaded your dryer, **always check that:**

- 1) The door is closed correctly.
- 2) The plug is secured in the socket.

Choose the desired program

The program is selected according to the type of garments that need to be dried. To choose a dryer time, refer to the table on page 13, then:

- 1) Turn **Dryer** knob to the desired position,
- 2) Press the **Power** button.

At the end of the dry cycle...

Turn the dryer off by pressing **Power button**. You can now open the dryer door safely. After having removed the freshly cleaned laundry, leave the door open to allow air circulation inside the drum. *Remember that, in the event of a power failure, or should the dryer switch itself off, the program chosen will remain in memory.*



DRYER HEAT

- Left Side Full heat 250° F
- Left Side Half Heat 150 F
- Right Side Fluff Dry No Heat

HOW TO DRY

Dryer

- Look at table **A** to the side and follow the instructions provided for **MAX** load to have an **automatic** washing and drying cycle.
- Follow the instructions (see page 12, the section "Starting the Dryer")
- Set the dryer time on **Dryer** knob.
- Press the **Power** button.

Table A: The best dry time also depends on the amount of laundry to be dried. Selecting the correct drying time, Use the following table as a guide:

Fabric	Load	Max load (lbs)	Drying Knob Sector	Drying Time (minutes)
Cottons	Laundry of different sizes	14	High Heat	120
Cottons	Only terry towels	11	High Heat	120
Mixed fabric (cotton+ polyester)	Sheets or shirts	9	Less Heat	80-90
Acrylics	Pajamas. Socks etc	9	Less Heat	60-70
Nylon	Petticoats. Stockings etc	7	Less Heat	40-50

- Load the clothes, no more than **14 lbs** for cottons, (see table for other fabrics), make sure that:
 - the door is shut correctly;
 - Power button has not been pressed
- Set dryer time on the **Dryer** knob
- Press **Power** button to start.

When Drying is Complete...

Turn the dryer off by pressing the Power button. Now you can open the appliance door. Once you have removed the dry clothes from the appliance, leave the door open or ajar to avoid the formation of bad odors.

USEFUL TIPS

Denim Alert:



















Some overalls have straps with hooks that can damage the drum of your machine or other garments during the dry. To minimize the risk, place hooks in the pocket and fasten with safety pins.

Vacations: unplug the appliance:

It is recommended that you should unplug the machine from the socket. Leave the door ajar to allow air to circulate through the door gasket area. This will prevent unpleasant odors.

UNDERSTANDING FABRIC CARE LABELS

The symbols on labels of your garments will help you in choosing the suitable wash program, the right temperature, wash cycles, and ironing methods. Don't forget to give a glance to these useful indications!

Machine Wash Cycle						
Water Temp.	●●● Hot (50°C/120°F)		●● Warm (40°C/105°F)		● Cold/Cool (30°C/85°F)	
Tumble Dry						
Special Instructions						
Bleach Symbols						

Select the right temperature...

Look !

MAINTENANCE

The Pinnacle by Majestic Tumble Dryer is designed to operate without complicated maintenance.

Follow these simple maintenance procedures for good results:

1. Ensure that your machine was installed according to the correct installation procedures detailed in this Manual.
2. Do not use solvents to clean the machine.

TECHNICAL DATA

Model	MJ9250D
Rated Volt	110-120V/60Hz
Drying input power	1560 W
Drying capacity	14 lbs
Outside dimensions (WXHxD)	33.5 x 23.5 x 21.6 (inches)
Weight	140 lbs

TROUBLESHOOTING

In most cases, when your dryer fails to work, the problems arising can be easily solved without having to call for a technician. Before calling for assistance, always check these points.

- ◆ **The dryer fails to start**
 - Is the plug correctly inserted into the socket?
 - Is there electricity in the house?
 - Is the door closed properly?
 - Is the power button pressed?

- ◆ **The dryer vibrates too much**
 - Have all shipping bolts been removed during installation?
 - Has the machine been leveled correctly?
 - Is there space between the machine and adjacent units?
 - Is the machine loaded evenly?
 - Is the machine installed on carpet or on a wooden floor?

- ◆ **The dryer is not drying**
 - Is the plug correctly inserted into the power outlet?
 - Is the door properly closed?
 - Is the dryer knob in the correct position indicating minutes for drying?

- ◆ **The dryer is not drying efficiently**
 - Is the drum overloaded?
 - Is fabric softener being used?



COMPANY INFORMATION

www.majesticpinnacle.com

SERVICE & SUPPORT:
service@majesticpinnacle.com
(866) 218-6902

Majestic Appliances
2801 W Sam Houston Pkwy N, Suite 195
Houston, TX 77043-1611
Phone (713) 933-1462 • Fax (832) 202-2732

*All rights reserved.
Manual subject to change without notice*

Free Manuals Download Website

<http://myh66.com>

<http://usermanuals.us>

<http://www.somanuals.com>

<http://www.4manuals.cc>

<http://www.manual-lib.com>

<http://www.404manual.com>

<http://www.luxmanual.com>

<http://aubethermostatmanual.com>

Golf course search by state

<http://golfingnear.com>

Email search by domain

<http://emailbydomain.com>

Auto manuals search

<http://auto.somanuals.com>

TV manuals search

<http://tv.somanuals.com>