



# Cordless Driver Drill

Equipped with Electric Brake

- MODEL 6202D**
- MODEL 6202DW**  
With Fast Charger
- MODEL 6202DWG**  
With Fast Charger

## INSTRUCTION MANUAL

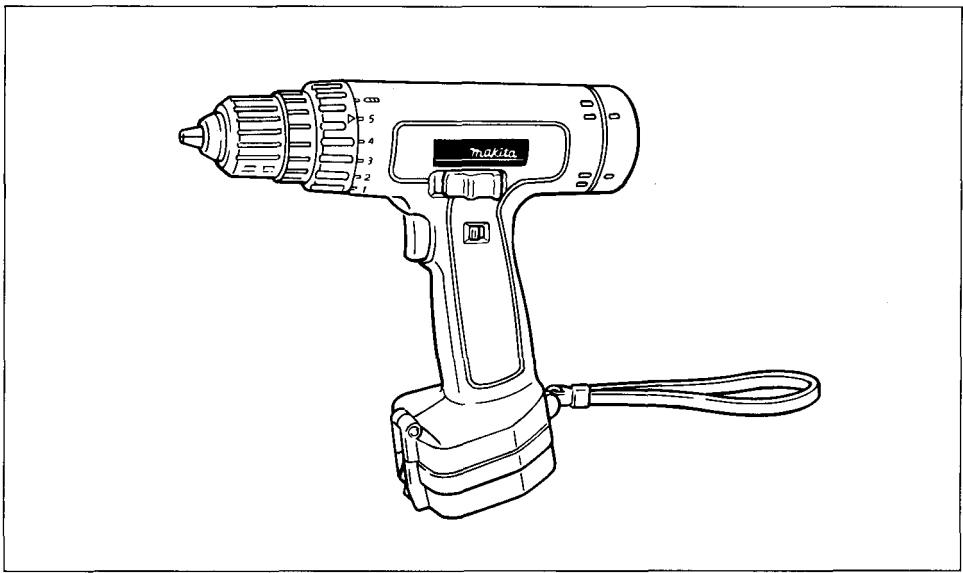

### SPECIFICATIONS

• Model 6202D

Capacities				No load speed (RPM)		Dimensions (L x W x H)	Net weight
Steel	Wood	Wood screw	Machine screw	High	Low		
10 mm (3/8")	21 mm (13/16")	6.1 mm x 55 mm (1/4" x 2-3/16")	6 mm (1/4")	0 - 1,100	0 - 350	237 mm x 57 mm x 243 mm (9-3/8" x 2-1/4" x 9-9/16")	1.7 kg (3.7 lbs)

• Battery Cartridge 9101 / 9101A

• Model DC1201 Fast Charger

Voltage	Input	Output	Charging time
9.6 V	A.C. only 50 Hz - 60 Hz	D.C. 7.2 V - 12 V	1 Hr.

\* Manufacturer reserves the right to change specifications without notice.  
 \* Note: Specifications may differ from country to country.

**WARNING:** For your personal safety, READ and UNDERSTAND before using.  
**SAVE THESE INSTRUCTIONS FOR FUTURE REFERENCE.**

# **IMPORTANT SAFETY INSTRUCTIONS**

## **(For All Tools)**

**WARNING: WHEN USING ELECTRIC TOOLS, BASIC SAFETY PRECAUTIONS SHOULD ALWAYS BE FOLLOWED TO REDUCE THE RISK OF FIRE, ELECTRIC SHOCK, AND PERSONAL INJURY, INCLUDING THE FOLLOWING:**

### **READ ALL INSTRUCTIONS.**

1. **KEEP WORK AREA CLEAN.** Cluttered areas and benches invite injuries.
2. **CONSIDER WORK AREA ENVIRONMENT.** Don't use power tools in damp or wet locations. Keep work area well lit. Don't expose power tools to rain. Don't use tool in presence of flammable liquids or gases.
3. **KEEP CHILDREN AWAY.** All visitors should be kept away from work area. Don't let visitors contact tool or extension cord.
4. **STORE IDLE TOOLS.** When not in use, tools should be stored in dry, and high or locked-up place — out of reach of children.
5. **DON'T FORCE TOOL.** It will do the job better and safer at the rate for which it was intended.
6. **USE RIGHT TOOL.** Don't force small tool or attachment to do the job of a heavy-duty tool. Don't use tool for purpose not intended; for example, don't use circular saw for cutting tree limbs or logs.
7. **DRESS PROPERLY.** Don't wear loose clothing or jewelry. They can be caught in moving parts. Rubber gloves and non-skid footwear are recommended when working outdoors. Wear protective hair covering to contain long hair.
8. **USE SAFETY GLASSES.** Also use face or dust mask if cutting operation is dusty.
9. **DON'T ABUSE CORD.** Never carry tool by cord or yank it to disconnect from receptacle. Keep cord from heat, oil, and sharp edges.
10. **SECURE WORK.** Use clamps or a vise to hold work. It's safer than using your hand and it frees both hands to operate tool.
11. **DON'T OVERREACH.** Keep proper footing and balance at all times.
12. **MAINTAIN TOOLS WITH CARE.** Keep tools sharp and clean for better and safer performance. Follow instructions for lubricating and changing accessories. Inspect tool cords periodically and if damaged, have repaired by authorized service facility. Inspect extension cords periodically and replace if damaged. Keep handles dry, clean, and free from oil and grease.
13. **DISCONNECT TOOLS.** When not in use, before servicing, and when changing accessories, such as blades, bits, cutters.

14. **REMOVE ADJUSTING KEYS AND WRENCHES.** Form habit of checking to see that keys and adjusting wrenches are removed from tool before turning it on.
15. **AVOID UNINTENTIONAL STARTING.** Don't carry tool with finger on switch. Be sure switch is OFF when plugging in.
16. **EXTENSION CORDS.** Make sure your extension cord is in good condition. When using an extension cord, be sure to use one heavy enough to carry the current your product will draw. An undersized cord will cause a drop in line voltage resulting in loss of power and overheating. Table 1 shows the correct size to use depending on cord length and nameplate ampere rating. If in doubt, use the next heavier gage. The smaller the gage number, the heavier the cord.

**TABLE 1 MINIMUM GAGE FOR CORD SETS**

			Total Length of Cord in Feet			
			0 – 25	26 – 50	51 – 100	101 – 150
Ampere Rating More Than	–	Not More Than	A W G			
0	–	6	18	16	16	14
6	–	10	18	16	14	12
10	–	12	16	16	14	12
12	–	16	14	12	Not Recommended	

17. **OUTDOOR USE EXTENSION CORDS.** When tool is used outdoors, use only extension cords intended for use outdoors and so marked.
18. **STAY ALERT.** Watch what you are doing, use common sense. Don't operate tool when you are tired.
19. **CHECK DAMAGED PARTS.** Before further use of the tool, a guard or other part that is damaged should be carefully checked to determine that it will operate properly and perform its intended function. Check for alignment of moving parts, binding of moving parts, breakage of parts, mounting, and any other conditions that may affect its operation. A guard or other part that is damaged should be properly repaired or replaced by an authorized service center unless otherwise indicated elsewhere in this instruction manual. Have defective switches replaced by authorized service center. Don't use tool if switch does not turn it on and off.
20. **GUARD AGAINST ELECTRIC SHOCK.** Prevent body contact with grounded surfaces. For example; pipes, radiators, ranges, refrigerator enclosures.
21. **REPLACEMENT PARTS.** When servicing, use only identical replacement parts.
22. **POLARIZED PLUGS.** To reduce the risk of electric shock, this equipment has a polarized plug (one blade is wider than the other). This plug will fit in a polarized outlet only one way. If the plug does not fit fully in the outlet, reverse the plug. If it still does not fit, contact a qualified electrician to install the proper outlet. Do not change the plug in any way.

**VOLTAGE WARNING:** Before connecting the tool to a power source (receptacle, outlet, etc.) be sure the voltage supplied is the same as that specified on the nameplate of the tool. A power source with voltage greater than that specified for the tool can result in **SERIOUS INJURY** to the user — as well as damage to the tool. If in doubt, **DO NOT PLUG IN THE TOOL**. Using a power source with voltage less than the nameplate rating is harmful to the motor.

# IMPORTANT SAFETY INSTRUCTIONS FOR CHARGER & BATTERY CARTRIDGE

- 1. SAVE THESE INSTRUCTIONS** — This manual contains important safety and operating instructions for battery charger.
2. Before using battery charger, read all instructions and cautionary markings on (1) battery charger, (2) battery, and (3) product using battery.
3. **CAUTION** — To reduce risk of injury, charge only MAKITA Battery Cartridge 9100 & 9101. Other types of batteries may burst causing personal injury and damage.
4. Do not expose charger to rain or snow.
5. Use of an attachment not recommended or sold by the battery charger manufacturer may result in a risk of fire, electric shock, or injury to persons.
6. To reduce risk of damage to electric plug and cord, pull by plug rather than cord when disconnecting charger.
7. Make sure cord is located so that it will not be stepped on, tripped over, or otherwise subjected to damage or stress.
8. An extension cord should not be used unless absolutely necessary. Use of improper extension cord could result in a risk of fire and electric shock. If extension cord must be used, make sure:
  - a. That pins on plug of extension cord are the same number, size, and shape as those of plug on charger;
  - b. That extension cord is properly wired and in good electrical condition; and
  - c. That wire size is at least as large as the one specified in the table below.

TABLE 1  
RECOMMENDED MINIMUM AWG SIZE FOR  
EXTENSION CORDS FOR BATTERY CHARGERS

Length of Cord (Feet)	25	50	100	150
AWG Size of Cord	18	18	18	16

9. Do not operate charger with damaged cord or plug — replace them immediately.
10. Do not operate charger if it has received a sharp blow, been dropped, or otherwise damaged in any way; take it to a qualified serviceman.
11. Do not disassemble charger or battery cartridge; take it to a qualified serviceman when service or repair is required. Incorrect reassembly may result in a risk of electric shock or fire.
12. To reduce risk of electric shock, unplug charger from outlet before attempting any maintenance or cleaning. Turning off controls will not reduce this risk.

## **ADDITIONAL SAFETY RULES FOR CHARGER & BATTERY CARTRIDGE**

- 1. Do not charge Battery Cartridge when temperature is BELOW 10°C (50°F) or ABOVE 40°C (104°F).**
- 2. Do not attempt to use a step-up transformer, an engine generator or DC power receptacle.**
- 3. Do not allow anything to cover or clog the charger vents.**
- 4. Always cover the battery terminals with the battery cover when the battery cartridge is not used.**
- 5. A battery short can cause a large current flow, overheating, possible burns and even a breakdown.**
  - (1) Do not touch the terminals with any conductive material.**
  - (2) Avoid storing battery cartridge in a container with other metal objects such as nails, coins, etc.**
  - (3) Do not expose battery cartridge to water or rain.**
- 6. Do not store the tool and Battery Cartridge in locations where the temperature may reach or exceed 50°C (122°F).**
- 7. Do not incinerate the Battery Cartridge even if it is severely damaged or is completely worn out. The battery cartridge can explode in a fire.**

## **ADDITIONAL SAFETY RULES FOR CORDLESS DRIVER DRILL**

- 1. Be aware that this tool is always in an operating condition, because it does not have to be plugged into an electrical outlet.**
- 2. Always be sure you have a firm footing.**  
**Be sure no one is below when using the tool in high locations.**
- 3. Hold the tool firmly.**
- 4. Keep hands away from rotating parts.**
- 5. When drilling into walls, floors or wherever "live" electrical wires may be encountered, DO NOT TOUCH ANY METAL PARTS OF THE TOOL!**  
**Hold the tool only by the insulated grasping surfaces to prevent electric shock if you drill into a "live" wire.**
- 6. Do not leave the tool running. Operate the tool only when hand-held.**
- 7. Do not touch the drill bit or the workpiece immediately after operation; they may be extremely hot and could burn your skin.**

**SAVE THESE INSTRUCTIONS.**

## Installing or removing battery cartridge

- Always switch off the tool before insertion or removal of the battery cartridge.
- To remove the battery cartridge, pull out the set plate on the tool and grasp both sides of the cartridge while withdrawing it from the tool.
- To insert the battery cartridge, align the tongue on the battery cartridge with the groove in the housing and slip it into place. Snap the set plate back into place. Be sure to close the set plate fully before using the tool.

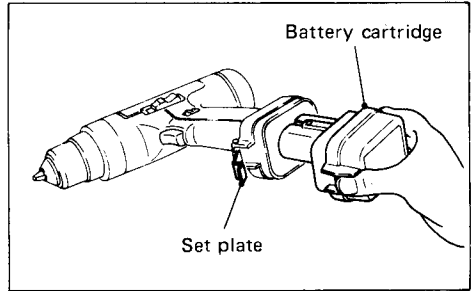

- Do not use force when inserting the battery cartridge. If the cartridge does not slide in easily, it is not being inserted correctly.

## Charging

- Your new battery cartridge is not charged. You will need to charge it before use. Use the fast charger Model DC1201 to charge the battery cartridge.
- Plug the fast charger into the proper A/C voltage source. The charging light will flash in green color.
- Insert the battery cartridge so that the plus and minus terminals on the battery cartridge are on the same sides as their respective markings on the fast charger. Insert the cartridge fully into the port so that it rests on the charger port floor.
- When the battery cartridge is inserted, the charging light color will change from green to red and charging will begin. The charging light will remain lit steadily during charging.
- When charging is completed, the charging light color will change from red to green and a tone will sound steadily for about 5 seconds. The charging time is approximately one hour.
- After charging, unplug the charger from the power source.

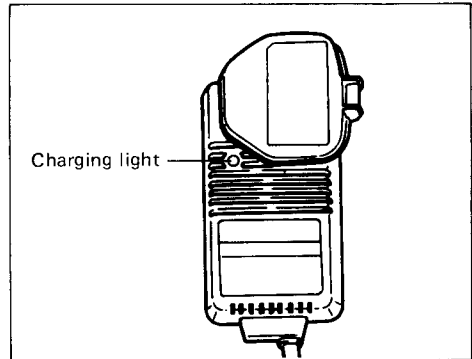

## CAUTION :

- The fast charger Model DC1201 is for charging Makita battery cartridge. Never use it for other purposes or for other manufacturer's batteries.
- When you charge a new battery cartridge or a battery cartridge which has not been used for a long period of time, it may not accept a full charge. This is a normal condition and does not indicate a problem. You can recharge the battery cartridge fully after discharging it completely and recharging a couple of times.

- If you charge a battery cartridge from a just-operated tool or a battery cartridge which has been left in a location exposed to direct sunlight or heat for a long time, the charging light may flash in red color. If this occurs, wait for a while. Charging will begin after the battery cartridge cools. The battery cartridge will cool faster if you remove the battery cartridge from the fast charger.
- If the charging light flashes alternately in green and red color and a tone sounds "beep, beep, beep, . . ." for about 20 seconds, a problem exists and charging is not possible. The terminals on the charger or battery cartridge are clogged with dust or the battery cartridge is worn out or damaged.
- If you wish to charge two battery cartridges, allow 15 minutes between chargings on the fast charger.

### Installing or removing driver bit or drill bit

#### CAUTION:

Always be sure that the tool is switched off and the battery cartridge is removed before installing or removing the bit.

To install the bit, push the sleeve up toward the "FREE" side and turn the sleeve counterclockwise while holding the ring with your other hand as illustrated at right.

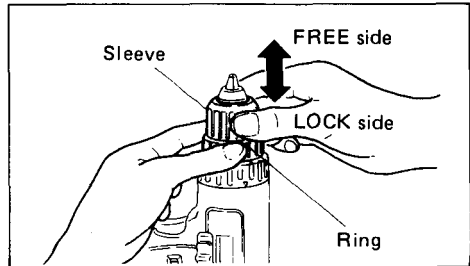

Place the bit in the chuck as far as it will go. Hold the ring firmly and turn the sleeve clockwise to tighten the chuck. Then push the sleeve down toward the "LOCK" side. See illustration.

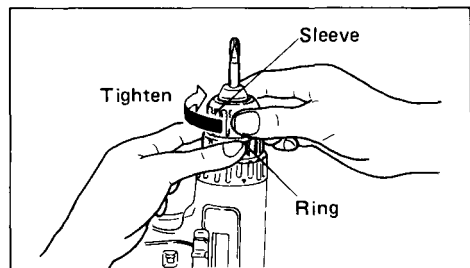

To remove the bit, push the sleeve up toward the "FREE" side and turn the sleeve counterclockwise while holding the ring with your other hand.

#### CAUTION:

- Do not attempt to turn the sleeve forcibly when the sleeve is in the "LOCK" position. The sleeve may be damaged.
- Always push the sleeve down toward the "LOCK" side before operation. If you operate the tool with the sleeve in the "FREE" position, the chuck may loosen and the bit may come out unexpectedly.



### Switch action

Tool speed is increased by increasing pressure on the trigger. To start the tool, simply pull the trigger. Release the trigger to stop.

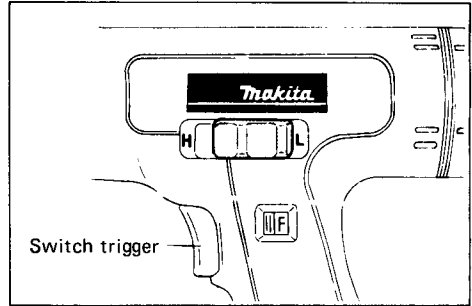

### CAUTION:

Before inserting the battery cartridge into the tool, always check to see that the switch trigger actuates properly and returns to the "OFF" position when released.

### Reversing switch action

This tool has a reversing switch to change the direction of rotation. Slide the reversing switch to the left for clockwise rotation or to the right for counterclockwise.

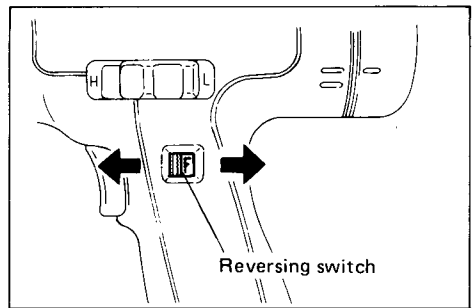

### CAUTION:

- Always check the direction of rotation before operation.
- Move the reversing switch only after the tool comes to a complete stop. Changing the direction of rotation before the tool stops may damage the tool.

### Speed change

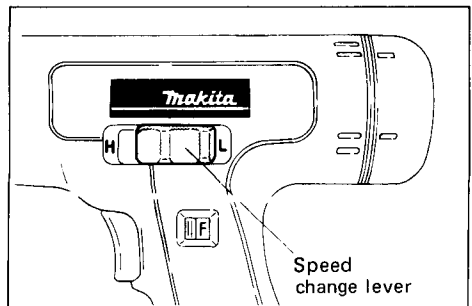

To change the speed, slide the speed change lever to the "H" side for high speed or "L" side for low speed. To slide the speed change lever easily, pull the trigger slightly while pushing the speed change lever. Be sure that the speed change lever is set to the correct position before operation. Use the high speed for your job.



### CAUTION:

Always set the speed change lever fully into the correct position. If you operate the tool with the speed change lever positioned halfway between the "H" side and "L" side, the tool may be damaged.

### Adjusting fastening torque

The fastening torque can be adjusted in six stages by turning the adjusting ring so that the pointer on the adjusting ring points to a number on the tool body. The fastening torque is minimum when the pointer points to the number 1 and maximum when it points to the  marking. The clutch will slip at varying torque levels when the pointer is set at the numbers 1 to 5. The clutch is designed not to slip at the  marking.

Before actual operation, drive a trial screw into your material or a piece of duplicate material to determine which torque level is required for a particular application.

#### NOTE :

The adjusting ring cannot be locked with the pointer positioned half-way between the numbers.

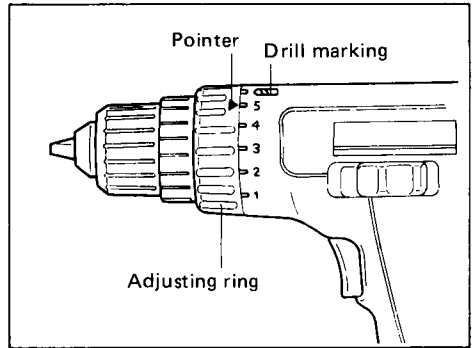

### Screwdriving operation

Place the point of the driver bit in the screw head and apply pressure to the tool. Start the tool slowly and then increase the speed gradually. Release the trigger as soon as the clutch cuts in.

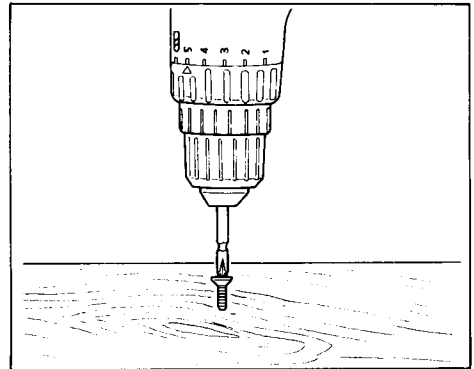

#### NOTE :

- Make sure that the driver bit is inserted straight in the screw head, or the screw and/or bit may be damaged.
- When driving wood screws, predrill pilot holes to make driving easier and to prevent splitting of the workpiece. See the chart.

Nominal diameter of wood screw (mm)	Recommended size of pilot hole (mm)
3.1 (1/8")	2.0 – 2.2 (5/64" – 3/32")
3.5 (9/64")	2.2 – 2.5 (3/32" – 3/32")
3.8 (5/32")	2.5 – 2.8 (3/32" – 7/64")
4.5 (11/64")	2.9 – 3.2 (7/64" – 1/8")
4.8 (3/16")	3.1 – 3.4 (1/8" – 9/64")
5.1 (13/64")	3.3 – 3.6 (1/8" – 9/64")
5.5 (7/32")	3.7 – 3.9 (9/64" – 5/32")
5.8 (7/32")	4.0 – 4.2 (5/32" – 11/64")
6.1 (15/64")	4.2 – 4.4 (11/64" – 11/64")

## Drilling operation

First, turn the adjusting ring so that the pointer on the adjusting ring points to the  marking. Then proceed as follows.

### • Drilling in wood

When drilling in wood, best results are obtained with wood drills equipped with a guide screw. The guide screw makes drilling easier by pulling the bit into the workpiece.

### • Drilling in metal

To prevent the bit from slipping when starting a hole, make an indentation with a center-punch and hammer at the point to be drilled place the point of the bit in the indentation and start drilling.

Use a cutting lubricant when drilling metals. The exceptions are iron and brass which should be drilled dry.

## CAUTION :

- Pressing excessively on the tool will not speed up the drilling. In fact, this excessive pressure will only serve to damage the tip of your bit, decrease the tool performance and shorten the service life of the tool.
- There is a tremendous force exerted on the tool/bit at the time of hole breakthrough. Hold the tool firmly and exert care when the bit begins to break through the workpiece.
- A stuck bit can be removed simply by setting the reversing switch to reverse rotation in order to back out. However, the tool may back out abruptly if you do not hold it firmly.
- Always secure small workpieces in a vise or similar hold-down device.

## Overload protector

The overload protector automatically cuts out to break the circuit whenever heavy work is prolonged. Wait 20–30 seconds before resuming operation.

## CAUTION:

Always withdraw the tool from the workpiece before resuming operation. If the tool cannot be withdrawn, hold the tool firmly when turning on the tool, to overcome a strong reaction.

## Hook

A hook is provided as a standard equipment. This hook is convenient for temporarily hanging the tool. To install the hook, first insert one end of the hook into one slot in the tool body and then insert the other end into the other slot. Secure the hook with the screw. The hook can be installed on either left or right side of the tool.

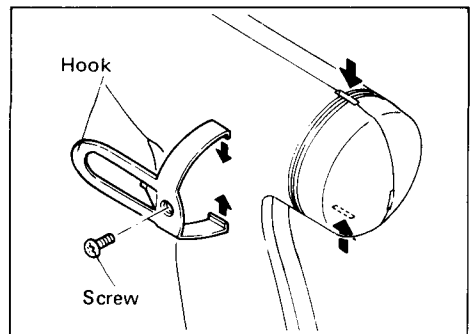

## **MAINTENANCE**

### **CAUTION:**

Always be sure that the tool is switched off and the battery cartridge is removed before attempting to perform inspection or maintenance.



To maintain product **SAFETY** and **RELIABILITY**, repairs, maintenance or adjustment should be performed by Makita Authorized or Factory Service Centers, always using Makita replacement parts.

## ACCESSORIES

### CAUTION:

These accessories or attachments are recommended for use with your Makita tool specified in this manual. The use of any other accessories or attachments might present a risk of injury to persons. The accessories or attachments should be used only in the proper and intended manner.

#### • Bits

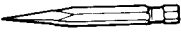
	Size	Part No.
 Phillips	# 2	784214-0A
	# 3	784215-0A
 Slotted	# 5F	784010-0A
	# 7F	784011-0A
 Square drill bit		784606-0A

#### • Fast charger

**Model DC1201**

Part No. 113126-0

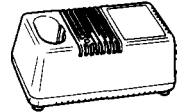

#### • Rubber pad assembly

Part No. 123001-2



#### • Battery cartridge 9100

Part No. 192019-4

#### • High capacity battery 9101

Part No. 192321-5

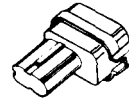

#### • Foam polishing pad

Part No. 743023-2

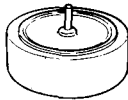

#### • Power display battery (High cap.) 9101A

Part No. 192404-1

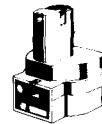

#### • Wool bonnet

Part No. 743401-6



#### • Battery cover

Part No. 414938-7



#### • Plastic carrying case



#### • Belt clip

Part No. 343951-7



# CORDLESS DRIVER DRILL Model 6202D

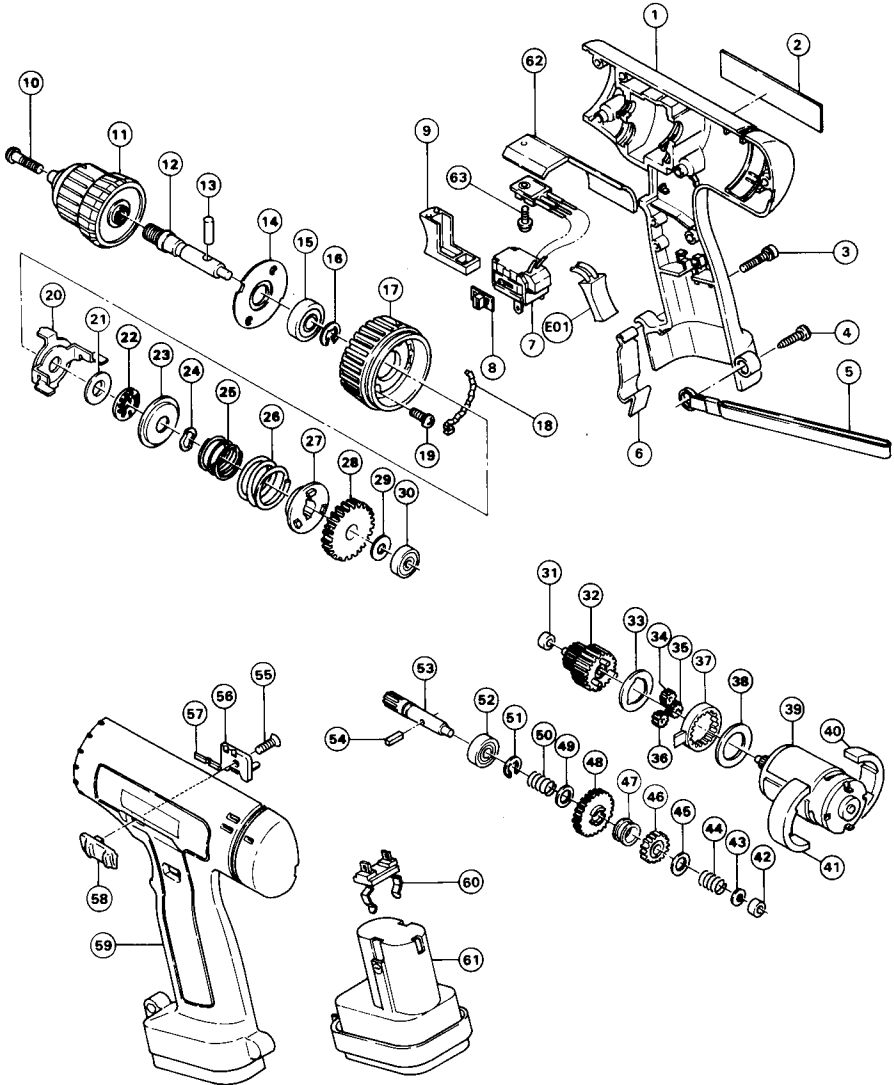

Note: The switch and other part configurations may differ from country to country.

ITEM NO.	NO. USED	DESCRIPTION	ITEM NO.	NO. USED	DESCRIPTION
<u>MACHINE</u>			<u>MACHINE</u>		
1	1	Housing Set (With Item 59)	33	1	Flat Washer 16
2	1	Name Plate	34	1	Spur Gear 15
3	1	Pan Head Screw M4x22 (With Washer)	35	1	Spur Gear 15
4	7	Tapping Screw BT4x20	36	1	Spur Gear 15
5	1	Hand Strap	37	1	Internal Gear 48
6	1	Set Plate	38	1	Flat Washer 18
7	1	Switch	39	1	DC Motor
8	1	Lever	40	1	Sponge 14-72
9	1	Switch Lever	41	1	Sponge 14-72
10	1	Pan Head Screw M5x22	42	1	Plane Bearing 4
11	1	Keyless Drill Chuck 10	43	1	Flat Washer 4
12	1	Spindle	44	1	Compression Spring 8
13	1	Pin 4	45	1	Thin Washer 8
14	1	Bearing Retainer 14	46	1	Spur Gear 25
15	1	Ball Bearing 600LLB	47	1	Ring 12
16	1	Stop Ring E-9	48	1	Spur Gear 40
17	1	Change Ring	49	1	Thin Washer 8
18	2	Cam Plate	50	1	Compression Spring 8
19	2	Pan Head Screw M4x12 (With Washer)	51	1	Stop Ring E-7
20	1	Slider	52	1	Ball Bearing 608LLB
21	1	Flat Washer 10	53	1	Spur Gear 8
22	1	Thrust Needle Gauge 1023	54	1	Key 3
23	1	Washer 10	55	1	Countersunk Head Screw M4x12
24	1	Wave Washer 10	56	1	Stopper
25	1	Compression Spring 22	57	1	Leaf Spring
26	1	Compression Spring 27	58	1	Lever
27	1	Clutch Cam	59	1	Housing Set (With Item 1)
28	1	Spur Gear 49	60	1	Battery Holder
29	1	Flat Washer 6	61	1	Battery 9100
30	1	Ball Bearing 626LLB	62	1	Radiating Plate
31	1	Plane Bearing 4	63	1	Pan Head Screw M3x10 (With Washer)
32	1	Gear Complete	E01	1	Over Current Relay

Note: The switch and other part specifications may differ from country to country.

# Recycling the Battery

The only way to dispose of a Makita battery is to recycle it. The law prohibits any other method of disposal.

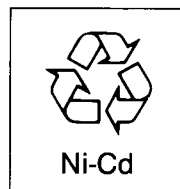

To recycle the battery:

1. Remove the battery from the tool.
  2. a). Take the battery to your nearest Makita Factory Service Center  
or  
b). Take the battery to your nearest Makita Authorized Service Center or Distributor that has been designated as a Makita battery recycling location.
- *Call your nearest Makita Service Center or Distributor to determine the location that provides Makita battery recycling. See your local Yellow Pages under "Tools-Electric".*

## MAKITA LIMITED ONE YEAR WARRANTY

### Warranty Policy

Every Makita tool is thoroughly inspected and tested before leaving the factory. It is warranted to be free of defects from workmanship and materials for the period of ONE YEAR from the date of original purchase. Should any trouble develop during this one-year period, return the COMPLETE tool, freight prepaid, to one of Makita's Factory or Authorized Service Centers. If inspection shows the trouble is caused by defective workmanship or material, Makita will repair (or at our option, replace) without charge.

This Warranty does not apply where:

- repairs have been made or attempted by others;
- repairs are required because of normal wear and tear;
- The tool has been abused, misused or improperly maintained;
- alterations have been made to the tool.

IN NO EVENT SHALL MAKITA BE LIABLE FOR ANY INDIRECT, INCIDENTAL OR CONSEQUENTIAL DAMAGES FROM THE SALE OR USE OF THE PRODUCT. THIS DISCLAIMER APPLIES BOTH DURING AND AFTER THE TERM OF THIS WARRANTY.

MAKITA DISCLAIMS LIABILITY FOR ANY IMPLIED WARRANTIES, INCLUDING IMPLIED WARRANTIES OF "MERCHANTABILITY" AND "FITNESS FOR A SPECIFIC PURPOSE," AFTER THE ONE-YEAR TERM OF THIS WARRANTY.

This Warranty gives you specific legal rights, and you may also have other rights which vary from state to state. Some states do not allow the exclusion or limitation of incidental or consequential damages, so the above limitation or exclusion may not apply to you. Some states do not allow limitation on how long an implied warranty lasts, so the above limitation may not apply to you.

## Makita Corporation

3-11-8, Sumiyoshi-cho,  
Anjo, Aichi 446 Japan

883904 - 061

PRINTED IN JAPAN

1994 - 9 - N



## Free Manuals Download Website

<http://myh66.com>

<http://usermanuals.us>

<http://www.somanuals.com>

<http://www.4manuals.cc>

<http://www.manual-lib.com>

<http://www.404manual.com>

<http://www.luxmanual.com>

<http://aubethermostatmanual.com>

Golf course search by state

<http://golfingnear.com>

Email search by domain

<http://emailbydomain.com>

Auto manuals search

<http://auto.somanuals.com>

TV manuals search

<http://tv.somanuals.com>