

# Makita

アメリカ

## Cordless Hammer Drill

Equipped with electric brake

**MODEL 8411D**

**MODEL 8411DW**

With Fast Charger

### INSTRUCTION MANUAL

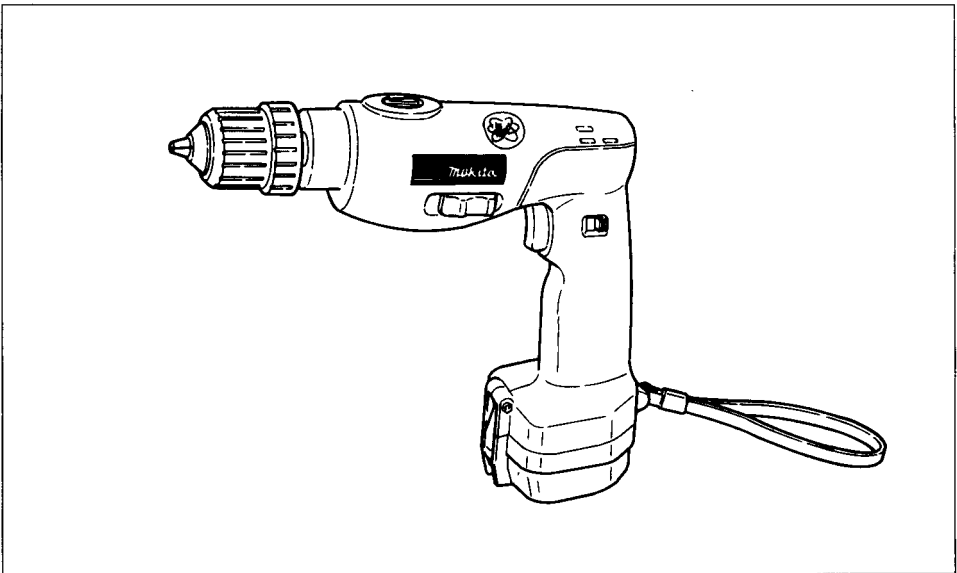

### SPECIFICATIONS

• Model 8411D

Capacities				No load speed (RPM)	
Steel	Wood	Wood screw	Concrete	High	Low
10 mm (3/8")	21 mm (13/16")	6.4 mm x 55 mm (1/4" x 2-3/16")	10 mm (3/8")	0 - 1,150	0 - 370
Blows per minute		Dimensions (L x W x H)		Net weight	
High	Low	273 mm x 79 mm x 220 mm (10-3/4" x 3-1/8" x 8-5/8")		1.87 kg (4.2 lbs)	
0 - 12,700	0 - 4,100				

• Battery Cartridge 1200

• Model DC1290 Fast Charger

Voltage	Input	Output	Charging time
12 V	A.C. only 50 Hz - 60 Hz	D.C. 9.6 V, 12 V	1 Hr.

- Manufacturer reserves the right to change specifications without notice.
- Note: Specifications may differ from country to country.

# **IMPORTANT SAFETY INSTRUCTIONS**

## **(For All Tools)**

**WARNING: WHEN USING ELECTRIC TOOLS, BASIC SAFETY PRECAUTIONS SHOULD ALWAYS BE FOLLOWED TO REDUCE THE RISK OF FIRE, ELECTRIC SHOCK, AND PERSONAL INJURY, INCLUDING THE FOLLOWING:**

### **READ ALL INSTRUCTIONS.**

- 1. KEEP WORK AREA CLEAN.** Cluttered areas and benches invite injuries.
- 2. CONSIDER WORK AREA ENVIRONMENT.** Don't use power tools in damp or wet locations. Keep work area well lit. Don't expose power tools to rain. Don't use tool in presence of flammable liquids or gases.
- 3. KEEP CHILDREN AWAY.** All visitors should be kept away from work area. Don't let visitors contact tool or extension cord.
- 4. STORE IDLE TOOLS.** When not in use, tools should be stored in dry, and high or locked-up place — out of reach of children.
- 5. DON'T FORCE TOOL.** It will do the job better and safer at the rate for which it was intended.
- 6. USE RIGHT TOOL.** Don't force small tool or attachment to do the job of a heavy-duty tool. Don't use tool for purpose not intended.
- 7. DRESS PROPERLY.** Don't wear loose clothing or jewelry. They can be caught in moving parts. Rubber gloves and non-skid footwear are recommended when working outdoors. Wear protective hair covering to contain long hair.
- 8. USE SAFETY GLASSES.** Also use face or dust mask if cutting operation is dusty.
- 9. DON'T ABUSE CORD.** Never carry tool by cord or yank it to disconnect from receptacle. Keep cord from heat, oil, and sharp edges.
- 10. SECURE WORK.** Use clamps or a vise to hold work. It's safer than using your hand and it frees both hands to operate tool.
- 11. DON'T OVERREACH.** Keep proper footing and balance at all times.
- 12. MAINTAIN TOOLS WITH CARE.** Keep tools sharp and clean for better and safer performance. Follow instructions for lubricating and changing accessories. Inspect tool cords periodically and if damaged, have repaired by authorized service facility. Inspect extension cords periodically and replace if damaged. Keep handles dry, clean, and free from oil and grease.
- 13. DISCONNECT TOOLS.** When not in use, before servicing, and when changing accessories, such as blades, bits, cutters.

14. **REMOVE ADJUSTING KEYS AND WRENCHES.** Form habit of checking to see that keys and adjusting wrenches are removed from tool before turning it on.
15. **AVOID UNINTENTIONAL STARTING.** Don't carry plugged-in tool with finger on switch. Be sure switch is OFF when plugging in.
16. **OUTDOOR USE EXTENSION CORDS.** When tool is used outdoors, use only extension cords intended for use outdoors and so marked.
17. **STAY ALERT.** Watch what you are doing, use common sense. Don't operate tool when you are tired.
18. **CHECK DAMAGED PARTS.** Before further use of the tool, a guard or other part that is damaged should be carefully checked to determine that it will operate properly and perform its intended function. Check for alignment of moving parts, binding of moving parts, breakage of parts, mounting, and any other conditions that may affect its operation. A guard or other part that is damaged should be properly repaired or replaced by an authorized service center unless otherwise indicated elsewhere in this instruction manual. Have defective switches replaced by authorized service center. Don't use tool if switch does not turn it on and off.
19. **GUARD AGAINST ELECTRIC SHOCK.** Prevent body contact with grounded surfaces. For example; pipes, radiators, ranges, refrigerator enclosures.
20. **REPLACEMENT PARTS.** When servicing, use only identical replacement parts.

**VOLTAGE WARNING:** Before connecting the tool to a power source (receptacle, outlet, etc.) be sure the voltage supplied is the same as that specified on the nameplate of the tool. A power source with voltage greater than that specified for the tool can result in **SERIOUS INJURY** to the user — as well as damage to the tool. If in doubt, **DO NOT PLUG IN THE TOOL.** Using a power source with voltage less than the nameplate rating is harmful to the motor.

# IMPORTANT SAFETY INSTRUCTIONS

1. **SAVE THESE INSTRUCTIONS** — This manual contains important safety and operating instructions for battery charger.
2. Before using battery charger, read all instructions and cautionary markings on (1) battery charger, (2) battery, and (3) product using battery.
3. **CAUTION** — To reduce risk of injury, charge only MAKITA Battery 1200, 1210, 9000 or 9100. Other types of batteries may burst causing personal injury and damage.
4. Do not expose charger to rain or snow.
5. Use of an attachment not recommended or sold by the battery charger manufacturer may result in a risk of fire, electric shock, or injury to persons.
6. To reduce risk of damage to electric plug and cord, pull by plug rather than cord when disconnecting charger.
7. Make sure cord is located so that it will not be stepped on, tripped over, or otherwise subjected to damage or stress.
8. An extension cord should not be used unless absolutely necessary. Use of improper extension cord could result in a risk of fire and electric shock. If extension cord must be used, make sure:
  - a. That pins on plug of extension cord are the same number, size, and shape as those of plug on charger;
  - b. That extension cord is properly wired and in good electrical condition; and
  - c. That wire size is at least as large as the one specified in the table below.

**TABLE 1**  
**RECOMMENDED MINIMUM AWG SIZE FOR**  
**EXTENSION CORDS FOR BATTERY CHARGERS**

Length of Cord (Feet)	25	50	100	150
AWG Size of Cord	18	18	18	16

9. Do not operate charger with damaged cord or plug — replace them immediately.
10. Do not operate charger if it has received a sharp blow, been dropped, or otherwise damaged in any way; take it to a qualified serviceman.
11. Do not disassemble charger or battery cartridge; take it to a qualified serviceman when service or repair is required. Incorrect reassembly may result in a risk of electric shock or fire.
12. To reduce risk of electric shock, unplug charger from outlet before attempting any maintenance or cleaning. Turning off controls will not reduce this risk.

## **ADDITIONAL SAFETY RULES FOR CHARGER & BATTERY CARTRIDGE**

1. Do not charge Battery Cartridge when temperature is BELOW 10°C (50°F) or ABOVE 40°C (104°F).
2. Do not attempt to use a step-up transformer, an engine generator or DC power receptacle.
3. Do not allow anything to cover or clog the charger vents.
4. Always cover the battery terminals with the battery cover when the battery cartridge is not used.
5. A battery short can cause a large current flow, overheating, possible burns and even a breakdown.
  - (1) Do not touch the terminals with any conductive material.
  - (2) Avoid storing battery cartridge in a container with other metal objects such as nails, coins, etc.
  - (3) Do not expose battery cartridge to water or rain.
6. Do not store the tool and Battery Cartridge in locations where the temperature may reach or exceed 50°C (122°F).
7. Do not incinerate the Battery Cartridge even if it is severely damaged or is completely worn out. The battery cartridge can explode in a fire.

## **ADDITIONAL SAFETY RULES**

1. Be aware that this tool is always in an operating condition, because it does not have to be plugged into an electrical outlet.
2. Wear a hard hat (safety helmet), safety glasses and/or face shield. It is also highly recommended that you wear a dust mask, ear protectors and thickly padded gloves.
3. Under normal operation, the tool is designed to produce vibration. The screws can come loose easily, causing a breakdown or accident. Check tightness of screws carefully before operation.
4. Always be sure you have a firm footing.  
Be sure no one is below when using the tool in high locations.
5. Hold the tool firmly.
6. Keep hands away from rotating parts.
7. Do not leave the tool running. Operate the tool only when hand-held.
8. When drilling into walls, floors or wherever "live" electrical wires may be encountered, DO NOT TOUCH ANY METAL PARTS OF THE TOOL!  
Hold the tool by the insulated grasping surfaces to prevent electric shock if you drill into a "live" wire.
9. Do not touch the bit or the workpiece immediately after operation; they may be extremely hot and could burn your skin.

**SAVE THESE INSTRUCTIONS.**

## Installing or removing battery cartridge

• Always switch off the tool before insertion or removal of the battery cartridge.

• To remove the battery cartridge, pull out the set plate on the tool and grasp both sides of the cartridge while withdrawing it from the tool.

• To insert the battery cartridge, align the tongue on the battery cartridge with the groove in the housing and slip it into place. Snap the set plate back into place. Be sure to close the set plate fully before using the tool.

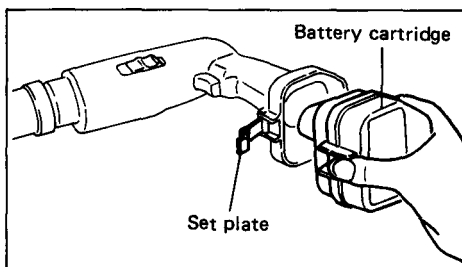

• Do not use force when inserting the battery cartridge.

If the cartridge does not slide in easily, it is not being inserted correctly.

## Charging

Plug the fast charger into your power source. Insert the battery cartridge so that the plus and minus terminals on the battery cartridge are on the same sides as their respective markings on the fast charger. Insert the cartridge fully into the port so that it rests on the charger port floor.

Press the start button (red). The charging light will come on and charging will begin. If the charging light does not come on, press the reset button (yellow) first, then the start button (red). If the charging light

goes out within 10 seconds even after pressing the reset button and start button a couple of times, the battery cartridge is dead. (CAUTION: Wait for more than 5 seconds after the charging light goes out to press the reset button again.) Replace it with a new one. When the charging light goes out after about one hour, you may remove the fully charged battery cartridge.

After charging, unplug the charger from the power source.

### CAUTION:

- Your new battery cartridge is not charged. You will need to charge it before use.
- Do not keep the button pressed in with tape, etc. or the circuit will not function properly. Also, a malfunction of the charger may result possibly causing overheating, etc.
- If you try to charge a cartridge from a just-operated tool, sometimes the charging light will not come on. If this occurs, let the cartridge cool off for a while. Then re-insert it and try to charge it once more.
- When you charge a new battery cartridge or a battery cartridge which has not been used for a long period, it may not accept a full charge. This is a normal condition and does not indicate a problem. You can recharge the battery cartridge fully after discharging it almost completely a couple of times.
- If you wish to charge two battery cartridges, allow 15 minutes between chargings on the fast charger.

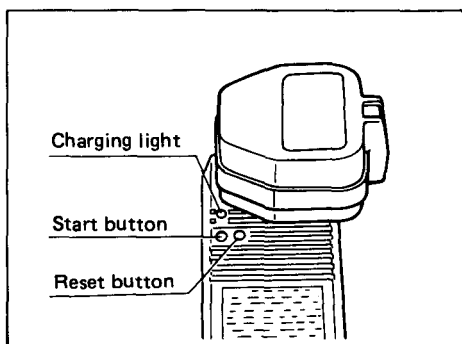

## Installing or removing drill bit or driver bit

### CAUTION:

Always be sure that the tool is switched off and the battery cartridge is removed before installing or removing the bit.

To install the bit, push the sleeve up toward the "FREE" side and turn the sleeve counterclockwise while holding the ring with your other hand as illustrated at right.

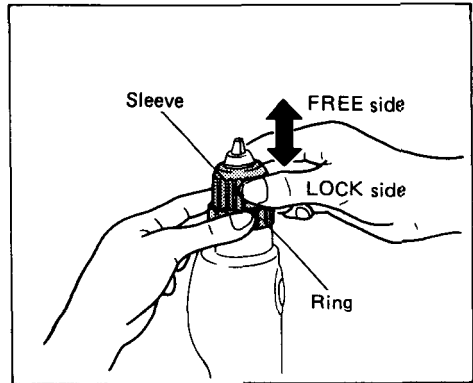

Place the bit in the chuck as far as it will go. Hold the ring firmly and turn the sleeve clockwise to tighten the chuck. Then push the sleeve down toward the "LOCK" side. See illustration.

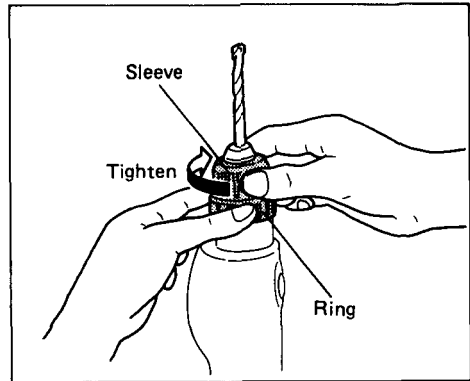

To remove the bit, push the sleeve up toward the "FREE" side and turn the sleeve counterclockwise while holding the ring with your other hand.

### CAUTION:

- Do not attempt to turn the sleeve forcibly when the sleeve is in the "LOCK" position. The sleeve may be damaged.
- Always push the sleeve down toward the "LOCK" side before operation. If you operate the tool with the sleeve in the "FREE" position, the chuck may loosen and the bit may come out unexpectedly.

### Switch action

Tool speed is increased by increasing pressure on the trigger. To start the tool, simply pull the trigger. Release the trigger to stop.

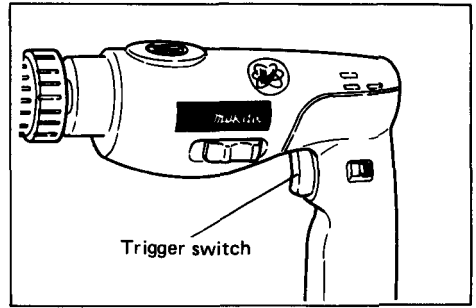

### CAUTION:

Before inserting the battery cartridge into the tool, always check to see that the trigger switch actuates properly and returns to the "OFF" position when released.

### Reversing switch action

This tool has a reversing switch to change the direction of rotation. Move the reversing switch to the left for clockwise rotation or to the right for counterclockwise.

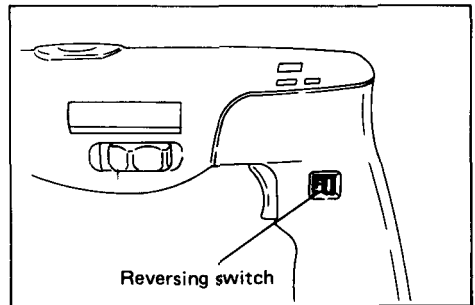

### CAUTION:

- Always check the direction of rotation before operation.
- Move the reversing switch only after the tool comes to a complete stop. Changing the direction of rotation before the tool stops may damage the tool.

### Speed change

To change the speed, slide the speed change lever to the "H" side for high speed or "L" side for low speed. To slide the speed change lever easily, pull the trigger slightly while pushing the speed change lever. Be sure that the speed change lever is set to the correct position before operation. Use the right speed for your job.

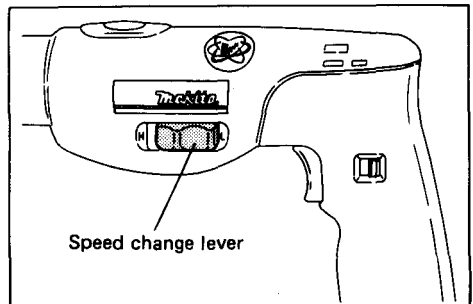



### CAUTION:

Always set the speed change lever fully into the correct position. If you operate the tool with the speed change lever positioned halfway between the "H" side and "L" side, the tool may be damaged.



## Operation

### 1) Hammer drilling operation :

When drilling in concrete, granite, tile, etc., turn the knob so that the  mark on the knob points to the  mark. Be sure to use a tungsten-carbide tipped bit. To position a hole accurately, start the tool slowly and then increase the speed gradually. Do not apply more pressure when the hole becomes clogged with chips or particles. Instead, run the tool at an idle, then remove the bit partially from the hole. By repeating this several times, the hole will be cleaned out.

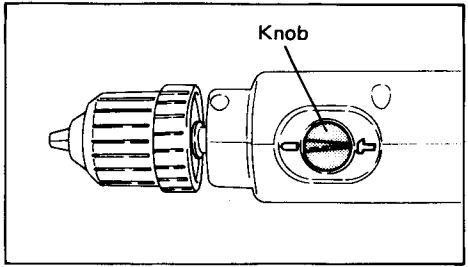



### CAUTION:

Pressing excessively on the tool will not speed up the drilling. In fact, this excessive pressure will only serve to damage the tip of your bit, decrease the tool performance and shorten the service life of the tool.

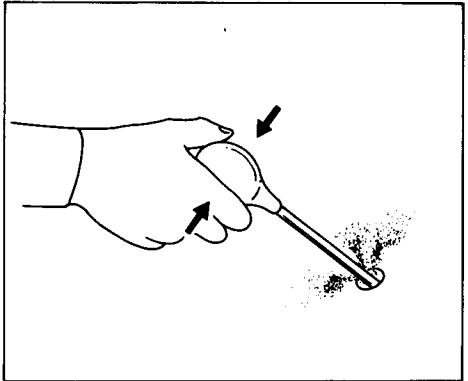
After drilling the hole, use the blow-out bulb to clean the dust out of the hole.



### 2) Drilling operation :

When drilling in wood, metal or plastic materials, turn the knob so that the  mark on the knob points to the  mark.

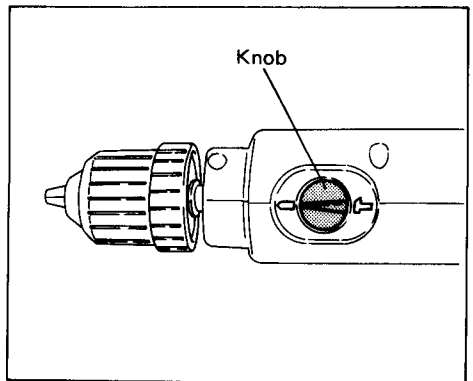

- **Drilling in wood**

When drilling in wood, best results are obtained with wood drills equipped with a guide screw. The guide screw makes drilling easier by pulling the bit into the workpiece.

- **Drilling in metal**

To prevent the bit from slipping when starting a hole, make an indentation with a center punch and hammer at the point to be drilled. Place the point of the bit in the indentation and start drilling.

Use a cutting lubricant when drilling metals. The exceptions are iron and brass which should be drilled dry.

**CAUTION:**

- Pressing excessively on the tool will not speed up the drilling. In fact, this excessive pressure will only serve to damage the tip of your bit, decrease the tool performance and shorten the service life of the tool.
- There is a tremendous force exerted on the tool/bit at the time of hole breakthrough. Hold the tool firmly and exert care when the bit begins to break through the workpiece.
- A stuck bit can be removed simply by setting the reversing switch to reverse rotation in order to back out. However, the tool may back out abruptly if you do not hold it firmly.
- Always secure small workpieces in a vise or similar hold-down device.

**CAUTION:**

If the tool is operated continuously until the battery cartridge has discharged, allow the tool to rest for 15 minutes before proceeding with a fresh battery.

## Dust cover

Use the dust cover to prevent dust and dirt from falling over the tool, yourself and on floor when performing overhead drilling operations. Install the dust cover on the tool's collar as shown in the figures below. When installing it, push the dust cover firmly enough to be completely installed on the tool's collar. An incompletely installed dust cover will contact the drill chuck, causing damage to the dust cover and/or drill.

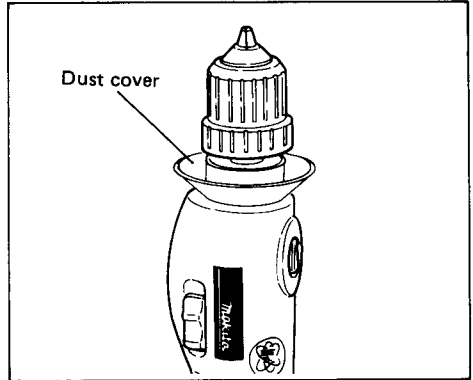
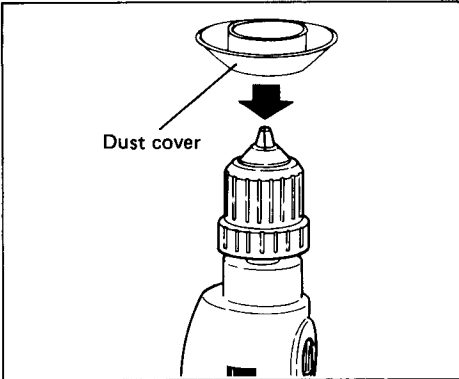

To remove the dust cover, slide it off firmly while turning it back and forth.

## MAINTENANCE

### CAUTION:

Always be sure that the tool is switched off and the battery cartridge is removed before attempting to perform inspection or maintenance.

To maintain product SAFETY and RELIABILITY, repairs, maintenance or adjustment should be performed by Makita Authorized or Factory Service Centers, always using Makita replacement parts.

## Recycling the Battery

The only way to dispose of a Makita battery is to recycle it. The law prohibits any other method of disposal.

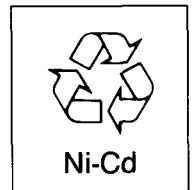

To recycle the battery:

1. Remove the battery from the tool.
2. a). Take the battery to your nearest Makita Factory Service Center  
or  
b). Take the battery to your nearest Makita Authorized Service Center or Distributor that has been designated as a Makita battery recycling location.
  - *Call your nearest Makita Service Center or Distributor to determine the location that provides Makita battery recycling. See your local Yellow Pages under "Tools-Electric".*

## ACCESSORIES

### CAUTION:

These accessories or attachments are recommended for use with your Makita tool specified in this manual. The use of any other accessories or attachments might present a risk of injury to persons. The accessories or attachments should be used only in the proper and intended manner.

#### • Heavy duty masonry drill bit for percussion drill



Part No.	Drill dia.	Shank dia.	Overall length
711120-A	3/16"	3/16"	4
711121-A	1/4"	1/4"	4
711122-A	1/4"	1/4"	6
711123-A	5/16"	1/4"	6
711124-A	3/8"	1/4"	6

#### • Drill bit



Part No.	Drill dia.	Shank dia.	Flute length	Overall length
711011-A	1/16"	1/16"	7/8"	1-7/8"
711012-A	3/32"	3/32"	1-1/4"	2-1/4"
711013-A	1/8"	1/8"	1-5/8"	2-3/4"
711014-A	5/32"	5/32"	2"	3-1/8"
711015-A	3/16"	3/16"	2-5/16"	3-1/2"
711016-A	7/32"	7/32"	2-1/2"	3-3/4"
711017-A	1/4"	1/4"	2-3/4"	4"
711018-A	9/32"	9/32"	2-5/16"	4-1/4"
711019-A	5/16"	5/16"	3-3/16"	4-1/2"
711020-A	11/32"	11/32"	3-7/16"	4-3/4"
711021-A	3/8"	3/8"	3-5/8"	5"

#### • Fast charger

Model DC1290

Part No. 113119-7

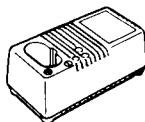

#### • Battery cartridge 1200

Part No. 632268-6

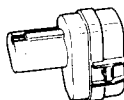

#### • Battery cover

Part No. 414938-7



#### • Dust cover

Part No. 415165-9



#### • Plastic carrying case

Part No. 182525-7

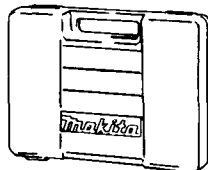

# CORDLESS HAMMER DRILL Model 8411D

**Type1**

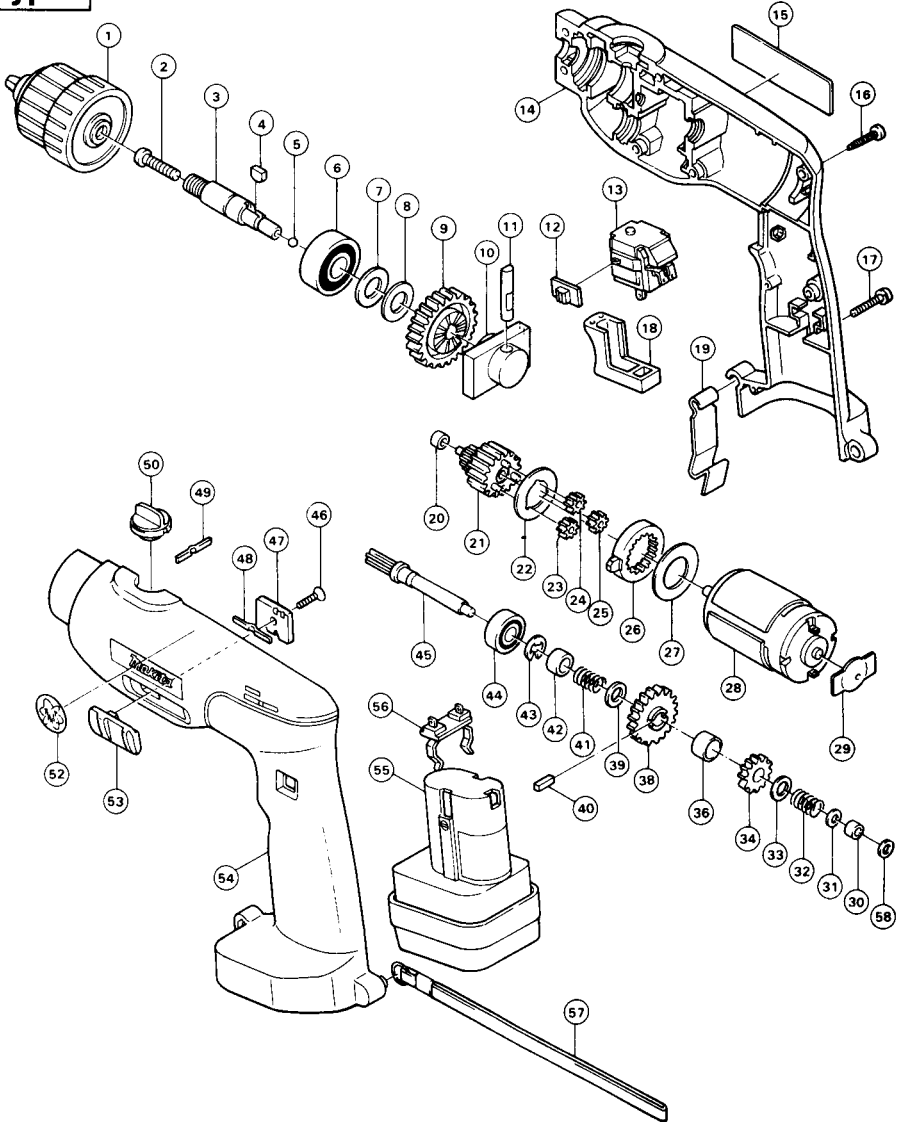

Note: The switch and other part configurations may differ from country to country.

ITEM NO.	NO. USED	DESCRIPTION	ITEM NO.	NO. USED	DESCRIPTION
<b>MACHINE</b>			<b>MACHINE</b>		
1	1	Keyless Drill Chuck 10	29	1	Motor Rear Cover
2	1	Pan Head Screw M5x22	30	1	Ball Bearing 694
3	1	Spindle	31	1	Flat Washer 4
4	1	Woodruff Key 4	32	1	Compression Spring 8
5	1	Steel Ball 4.8	33	1	Thin Washer 8
6	1	Ball Bearing 6201DDW	34	1	Spur Gear 25
7	1	Flat Washer 12	36	1	Ring 12
8	1	Flat Washer 12	38	1	Spur Gear 40
9	1	Spur Gear 55	39	1	Thin Washer 8
10	1	Cam	40	1	Key 3
11	1	Shifter Pin	41	1	Compression Spring 8
12	1	Lever	42	1	Sleeve 8
13	1	Switch	43	1	Stop Ring E-7
14	1	Housing Set (With Item 54)	44	1	Ball Bearing 608LLB
15	1	Name Plate	45	1	Spur Gear 9
16	8	Tapping Screw BT4x20	46	1	Countersunk Head Screw M4x12
17	1	Pan Head Screw M4x22 (With Washer)	47	1	Stopper
18	1	Switch Lever	48	1	Leaf Spring
19	1	Set Plate	49	1	Leaf Spring
20	1	Plane Bearing 4	50	1	Knob
21	1	Gear	52	1	Label
22	1	Flat Washer 16	53	1	Lever
23	1	Spur Gear 15	54	1	Housing Set (With Item 14)
24	1	Spur Gear 15	55	1	Battery 1200
25	1	Spur Gear 15	56	1	Battery Holder
26	1	Internal Gear 48	57	1	Hand Strap
27	1	Flat Washer 18	58	1	Flat Washer 4
28	1	DC Motor 12 V			

Note: The switch and other part specifications may differ from country to country.



## MAKITA LIMITED ONE YEAR WARRANTY

### Warranty Policy

Every Makita tool is thoroughly inspected and tested before leaving the factory. It is warranted to be free of defects from workmanship and materials for the period of ONE YEAR from the date of original purchase. Should any trouble develop during this one-year period, return the COMPLETE tool, freight prepaid, to one of Makita's Factory or Authorized Service Centers. If inspection shows the trouble is caused by defective workmanship or material, Makita will repair (or at our option, replace) without charge.

This Warranty does not apply where:

- repairs have been made or attempted by others;
- repairs are required because of normal wear and tear;
- The tool has been abused, misused or improperly maintained;
- alterations have been made to the tool.

IN NO EVENT SHALL MAKITA BE LIABLE FOR ANY INDIRECT, INCIDENTAL OR CONSEQUENTIAL DAMAGES FROM THE SALE OR USE OF THE PRODUCT. THIS DISCLAIMER APPLIES BOTH DURING AND AFTER THE TERM OF THIS WARRANTY.

MAKITA DISCLAIMS LIABILITY FOR ANY IMPLIED WARRANTIES, INCLUDING IMPLIED WARRANTIES OF "MERCHANTABILITY" AND "FITNESS FOR A SPECIFIC PURPOSE," AFTER THE ONE-YEAR TERM OF THIS WARRANTY.

This Warranty gives you specific legal rights, and you may also have other rights which vary from state to state. Some states do not allow the exclusion or limitation of incidental or consequential damages, so the above limitation or exclusion may not apply to you. Some states do not allow limitation on how long an implied warranty lasts, so the above limitation may not apply to you.

**Makita Corporation**  
3-11-8, Sumiyoshi-cho,  
Anjo, Aichi 446 Japan

883808 — 067



## Free Manuals Download Website

<http://myh66.com>

<http://usermanuals.us>

<http://www.somanuals.com>

<http://www.4manuals.cc>

<http://www.manual-lib.com>

<http://www.404manual.com>

<http://www.luxmanual.com>

<http://aubethermostatmanual.com>

Golf course search by state

<http://golfingnear.com>

Email search by domain

<http://emailbydomain.com>

Auto manuals search

<http://auto.somanuals.com>

TV manuals search

<http://tv.somanuals.com>