

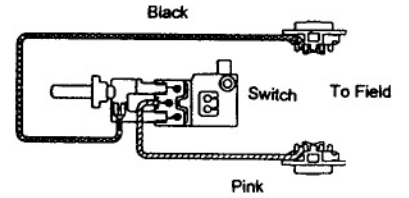

6-1/2" (165MM) CORDLESS CIRCULAR SAW

MODEL 5630D
5630DWA

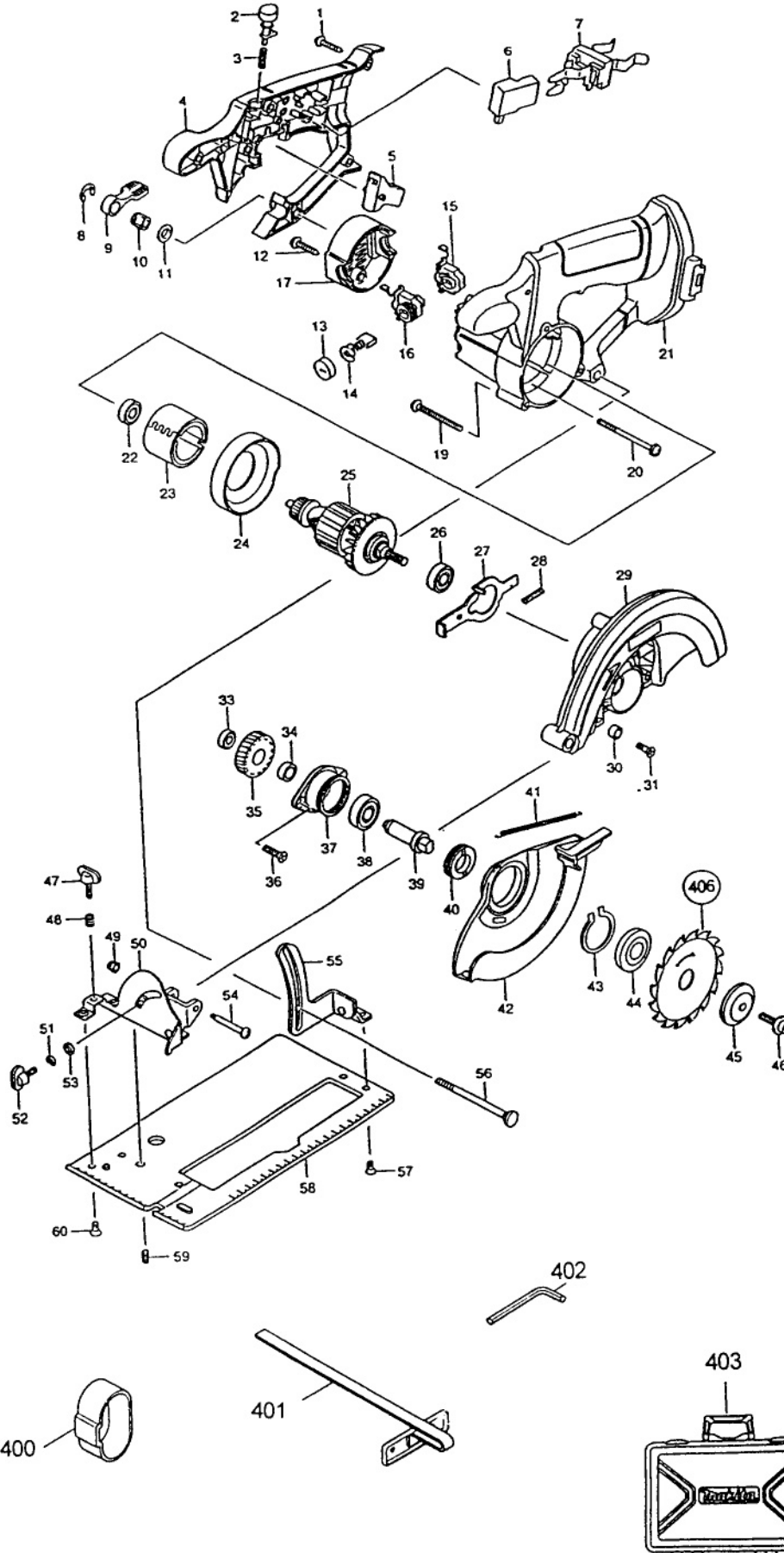

IMPORTANT! – To assure product SAFETY and RELIABILITY, repairs, maintenance or adjustments should be performed by MAKITA Service Centers, or other qualified service organizations. Always use MAKITA replacement parts.

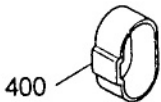
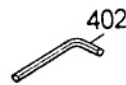
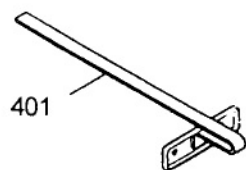
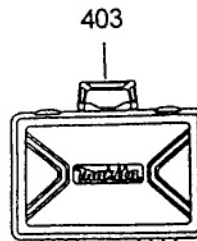
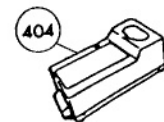

Fig.	Part No.	Qty. Used	Description	Fig.	Part No.	Qty. Used	Description
1	265995-6	6	TAPPING SCREW 4x18	35	226370-1	1	SPUR GEAR 53
2	416644-0	1	SWITCH BUTTON	36	265034-2	2	C. HEAD SCREW M5x16
3	233194-8	1	COMPRESSION SPRING 4	37	316766-5	1	BEARING BOX
4	416844-2	1	HANDLE COVER	38	211129-9	1	BALL BEARING 6201DDW
5	416642-4	1	SWITCH LEVER	39	323797-7	1	SPINDLE
6	651956-6	1	SWITCH TG72BD	40	285802-7	1	BEARING RETAINER 19-33
7	643942-1	1	BATTER HOLDER	41	231821-1	1	TENSION SPRING 3
8	961014-3	1	STOP RING E-8	42	416596-5	1	SAFETY COVER
9	272229-0	1	LEVER 40	43	961155-5	1	RETAINING RINGS S-38
10	252158-3	1	HEX NUT M6	44	224151-7	1	INNER FLANGE 40 5/8"
11	253804-1	1	FLAT WASHER 6	45	224275-9	1	OUTER FLANGE 40
12	265995-6	2	TAPPING SCREW 4x18	46	266133-3	1	H. S. HEAD BOLT M6x20
13	643941-3	2	HOLDER CAP	47	265701-9	1	SCREW M6x14
14	191970-5	1	CARBON BRUSH CB-429 (2 PCS SET)	48	231316-4	1	COMPRESSION SPRING 7
15	643939-0	1	BRUSH HOLDER	49	252103-8	1	HEX LOCK NUT M5-8
16	643940-5	1	BRUSH HOLDER (INCL. 1 EA. RECEPTACLE 654187-6)	50	163404-8	1	DEPTH COMPLETE
17	416639-3	1	REAR COVER	51	942151-2	1	SPRING WASHER 6
19	911263-2	3	PAN HEAD SCREW M5x40	52	265701-9	1	SCREW M6x14
20	266209-6	2	TAPPING SCREW 4x60	53	941151-9	1	FLAT WASHER 6
21	416843-4	1	MOTOR HOUSING	54	265056-2	1	PAN HEAD SCREW M5
22	211026-9	1	BALL BEARING 627LLB	55	163403-0	1	ANGULAR COMPLETE
23	632828-4	1	YOKE UNIT	56	266194-3	1	FLAT HEAD SCREW M6x90
24	416641-6	1	BAFFLE PLATE	57	912107-9	2	C. HEAD SCREW M5x8
25	519049-4	1	ARMATURE ASS'Y 14.4V (INCL. FIG. 22, 26)	58	317074-7	1	BASE
26	211061-7	1	BALL BEARING 6000LLB	59	266180-4	1	SCREW M5x12
27	344657-0	1	SHAFT LOCK	60	912202-5	3	C. HEAD SCREW M5x8
28	233092-6	1	COMPRESSION SPRING 5	<u>ACCESSORIES</u>			
29	150995-8	1	BLADE CASE CPL. (INCL. 1 EA CAUTION LABEL 810939-7, 1 EA O-RING 26)	400	414938-7	1	BATTERY COVER
30	262049-0	1	RUBBER RING 6	401	164095-8	1	GUIDE RULE
31	251368-9	1	COUNTERSUNK SCREW M6	402	783203-8	1	HEX WRENCH 5
33	211014-6	1	BALL BEARING 606	403	824524-0	1	PLASTIC CARRYING CASE
34	257010-0	1	RING 12	404	DC1411	1	FAST CHARGER DC1411
				405	192600-1	1	HIGH CAPACITY BATTERY 1422 (14.4V-2.0AH)
				406	A-85092	1	T.C.T. SAWBLADE 24T

2 MODEL 5630D
MODEL 5630DWA

04-99

Free Manuals Download Website

<http://myh66.com>

<http://usermanuals.us>

<http://www.somanuals.com>

<http://www.4manuals.cc>

<http://www.manual-lib.com>

<http://www.404manual.com>

<http://www.luxmanual.com>

<http://aubethermostatmanual.com>

Golf course search by state

<http://golfingnear.com>

Email search by domain

<http://emailbydomain.com>

Auto manuals search

<http://auto.somanuals.com>

TV manuals search

<http://tv.somanuals.com>