

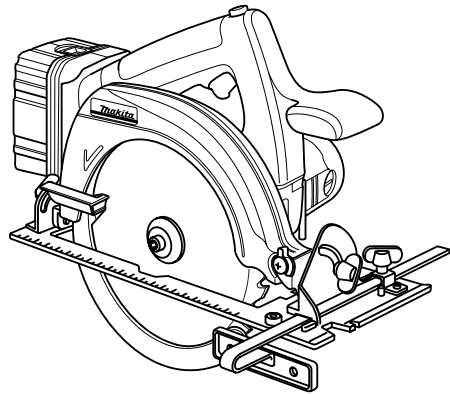

# Cordless Circular Saw

Equipped with Electric Blade Brake  
185 mm (7-1/4")  
MODEL BSS730



001324

## I N S T R U C T I O N   M A N U A L

**⚠ WARNING:**

For your personal safety, READ and UNDERSTAND before using.  
SAVE THESE INSTRUCTIONS FOR FUTURE REFERENCE.

---

# SPECIFICATIONS

MODEL		BSS730
Blade diameter		185 mm (7-1/4")
Max. Cutting depth	at 90°	64 mm (2-1/2")
	at 45°	45 mm (1-3/4")
	at 50°	41 mm (1-5/8")
No load speed (RPM)		2,400/min.
Overall length		375 mm (14-3/4")
Net weight		4.0 kg (8.8 lbs)
<hr/>		
Battery Charger	DC24SA	
Input	A. C. only 50 Hz - 60 Hz	
Output	D. C. 7.2 V - 12 V	
Battery Cartridge	B2417	B2430
Voltage	24 V	
Charging time	30 min.	60 min.

- Manufacturer reserves the right to change specifications without notice.
- Specifications may differ from country to country.

---

# GENERAL SAFETY RULES

USA003-1

## (FOR ALL BATTERY OPERATED TOOLS)

### **⚠ WARNING:**

**Read and understand all instructions.** Failure to follow all instructions listed below, may result in electric shock, fire and/or serious personal injury.

---

# SAVE THESE INSTRUCTIONS

## Work Area

1. **Keep your work area clean and well lit.** Cluttered benches and dark areas invite accidents.

2. **Do not operate power tools in explosive atmospheres, such as in the presence of flammable liquids, gases, or dust.** Power tools create sparks which may ignite the dust or fumes.
3. **Keep bystanders, children, and visitors away while operating a power tool.** Distractions can cause you to lose control.

### Electrical Safety

4. **A battery operated tool with integral batteries or a separate battery pack must be recharged only with the specified charger for the battery.** A charger that may be suitable for one type of battery may create a risk of fire when used with another battery.
5. **Use battery operated tool only with specifically designated battery pack.** Use of any other batteries may create a risk of fire.

### Personal Safety

6. **Stay alert, watch what you are doing, and use common sense when operating a power tool. Do not use tool while tired or under the influence of drugs, alcohol, or medication.** A moment of inattention while operating power tools may result in serious personal injury.
7. **Dress properly. Do not wear loose clothing or jewelry. Contain long hair. Keep your hair, clothing, and gloves away from moving parts.** Loose clothes, jewelry, or long hair can be caught in moving parts.
8. **Avoid accidental starting. Be sure switch is in the locked or off position before inserting battery pack.** Carrying tools with your finger on the switch or inserting the battery pack into a tool with the switch on invites accidents.
9. **Remove adjusting keys or wrenches before turning the tool on.** A wrench or a key that is left attached to a rotating part of the tool may result in personal injury.
10. **Do not overreach. Keep proper footing and balance at all times.** Proper footing and

balance enable better control of the tool in unexpected situations.

11. **Use safety equipment. Always wear eye protection.** Dust mask, non-skid safety shoes, hard hat, or hearing protection must be used for appropriate conditions.

### Tool Use and Care

12. **Use clamps or other practical way to secure and support the workpiece to a stable platform.** Holding the work by hand or against your body is unstable and may lead to loss of control.
13. **Do not force tool. Use the correct tool for your application.** The correct tool will do the job better and safer at the rate for which it is designed.
14. **Do not use tool if switch does not turn it on or off.** A tool that cannot be controlled with the switch is dangerous and must be repaired.
15. **Disconnect battery pack from tool or place the switch in the locked or off position before making any adjustments, changing accessories, or storing the tool.** Such preventive safety measures reduce the risk of starting the tool accidentally.
16. **Store idle tools out of reach of children and other untrained persons.** Tools are dangerous in the hands of untrained users.
17. **When battery pack is not in use, keep it away from other metal objects like: paper clips, coins, keys, nails, screws, or other small metal objects that can make a connection from one terminal to another.** Shorting the battery terminals together may cause sparks, burns, or a fire.
18. **Maintain tools with care. Keep cutting tools sharp and clean.** Properly maintained tools with sharp cutting edge are less likely to bind and are easier to control.
19. **Check for misalignment or binding of moving parts, breakage of parts, and any other condition that may affect the tool's**

---

operation. If damaged, have the tool serviced before using. Many accidents are caused by poorly maintained tools.

20. **Use only accessories that are recommended by the manufacturer for your model.** Accessories that may be suitable for one tool may create a risk of injury when used on another tool.

## SERVICE

21. **Tool service must be performed only by qualified repair personnel.** Service or maintenance performed by unqualified personnel may result in a risk of injury.
22. **When servicing a tool, use only identical replacement parts. Follow instructions in the Maintenance section of this manual.** Use of unauthorized parts or failure to follow Maintenance instructions may create a risk of shock or injury.

---

## SPECIFIC SAFETY RULES

USB027-5

**DO NOT let comfort or familiarity with product (gained from repeated use) replace strict adherence to circular saw safety rules. If you use this tool unsafely or incorrectly, you can suffer serious personal injury.**

1. **DANGER! Keep hands away from cutting area and blade. Keep your second hand on auxiliary handle or motor housing.** If both hands are holding the saw, they cannot be cut by the blade.  
**Keep your body positioned to either side of the saw blade, but not in line with the saw blade.** KICKBACK could cause the saw to jump backwards. (See “Causes and Operator Prevention of Kickback”)  
**Do not reach underneath the work.** The guard can not protect you from the blade below the work. Do not attempt to remove cut material when blade is moving.  
CAUTION: Blades coast after turn off. Wait until blade stops before grasping cut material.
2. **Check lower guard for proper closing before each use. Do not operate saw if lower guard does not move freely and close instantly. Never clamp or tie the lower guard into the open position.** If saw is accidentally dropped, lower guard may be bent. Raise the lower guard with the Retract-

ing Lever and make sure it moves freely and does not touch the blade or any other part, in all angles and depths of cut.

To check lower guard, open lower guard by hand, then release and watch guard closure. Also check to see that Retracting Lever does not touch tool housing. Leaving blade exposed is VERY DANGEROUS and can lead to serious personal injury.

3. **Check the operation and condition of the lower guard spring. If the guard and the spring are not operating properly, they must be serviced before use.** Lower guard may operate sluggishly due to damaged parts, gummy deposits, or a buildup of debris.
4. **Lower guard should be retracted manually only for special cuts such as “Pocket Cuts” and “Compound Cuts.” Raise lower guard by Retracting Lever. As soon as blade enters the material, lower guard must be released.** For all other sawing, the lower guard should operate automatically.

5. **Always observe that the lower guard is covering the blade before placing saw down on bench or floor.** An unprotected, coasting blade will cause the saw to walk backwards, cutting whatever is in its path. Be aware of the time it takes for the blade to stop after switch is released.
6. **NEVER hold piece being cut in your hands or across your leg.** It is important to support the work properly to minimize body exposure, blade binding, or loss of control.
7. **Hold tool by insulated gripping surfaces when performing an operation where the cutting tool may contact hidden wiring.** Contact with a "live" wire will also make exposed metal parts of the tool "live" and shock the operator.
8. **When ripping always use a rip fence or straight edge guide.** This improves the accuracy of cut and reduces the chance for blade binding.
9. **Always use blades with correct size and shape (diamond vs. round) arbor holes.** Blades that do not match the mounting hardware of the saw will run eccentrically, causing loss of control.
10. **Never use damaged or incorrect blade washers or bolts.** The blade washers and bolt were specially designed for your saw, for optimum performance and safety of operation.
11. **Causes and Operator Prevention of Kickback:**

Kickback is a sudden reaction to a pinched, bound, or misaligned saw blade, causing an uncontrolled saw to lift up and out of the workpiece toward the operator.

When the blade is pinched or bound tightly by the kerf closing down, the blade stalls and the motor reaction drives the unit rapidly back toward the operator.

If the blade becomes twisted or misaligned in the cut, the teeth at the back edge of the blade can dig into the top surface of the wood causing the blade to climb out of the kerf and

jump back toward the operator.

Kickback is the result of tool misuse and/or incorrect operating procedures or conditions and can be avoided by taking proper precautions as given below:

**Maintain a firm grip on the saw and position your body and arm in a way that allows you to resist KICKBACK forces.** KICKBACK forces can be controlled by the operator, if proper precautions are taken.

**When blade is binding, or when interrupting a cut for any reason, release the trigger and hold the saw motionless in the material until the blade comes to a complete stop. Never attempt to remove the saw from the work or pull the saw backward while the blade is in motion or KICKBACK may occur.** Investigate and take corrective actions to eliminate the cause of blade binding.

**When restarting a saw in the workpiece, center the saw blade in the kerf and check that teeth are not engaged into the material.** If saw blade is binding, it may walk up or KICKBACK from the workpiece as the saw is restarted.

**Support large panels to minimize the risk of blade pinching and KICKBACK.** Large panels tend to sag under their own weight. Supports must be placed under the panel on both sides, near the line of cut and near the edge of the panel as shown in Fig. 1.

To minimize the risk of blade pinching and kickback. When cutting operation requires the resting of the saw on the workpiece, the saw shall be rested on the larger portion and the smaller piece cut off.

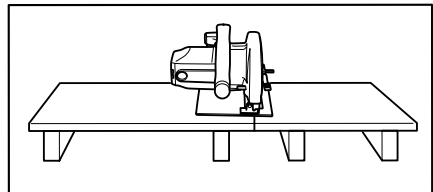

Fig. 1

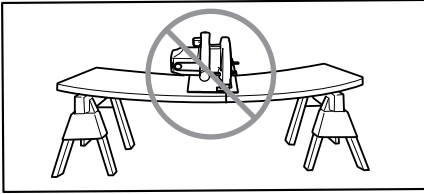

Fig. 2

**Do not use dull or damaged blade.**

Unsharpened or improperly set blades produce narrow kerf causing excessive friction, blade binding and KICKBACK. Keep blade sharp and clean. Gum and wood pitch hardened on blades slows saw and increases potential for kickback. Keep blade clean by first removing it from tool, then cleaning it with gum and pitch remover, hot water or kerosene. Never use gasoline.

**Blade depth and bevel adjusting locking levers must be tight and secure before making cut.** If blade adjustment shifts while cutting, it will cause binding and KICKBACK.

**Use extra caution when making a "Pocket Cut" into existing walls or other blind areas.** The protruding blade may cut objects that can cause KICKBACK. For pocket cuts, retract lower guard using Retracting Lever.

**ALWAYS hold the tool firmly with both hands. NEVER place your hand or fingers behind the saw.** If kickback occurs, the saw could easily jump backwards over your hand, leading to serious personal injury.

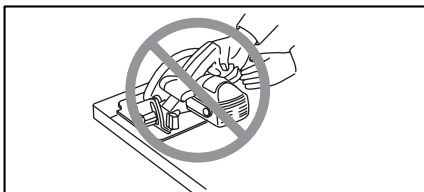

Fig. 3

**Never force the saw. Forcing the saw can cause uneven cuts, loss of accuracy, and possible kickback.**

Push the saw forward at a speed so that the blade cuts without slowing.

12. Be aware that this tool is always in an operating condition, because it does not have to be plugged into an electrical outlet.

13. Use extra caution when cutting damp wood, pressure treated lumber, or wood containing knots. Adjust speed of cut to maintain smooth advancement of tool without decrease in blade speed.

14. Adjustments. Before cutting be sure depth and bevel adjustments are tight.

15. Avoid Cutting Nails. Inspect for and remove all nails from lumber before cutting.

16. The tool is provided with a front grip and rear handle for two hand operation. Operate with proper hand support and proper workpiece support.

**WARNING:** It is important to support the workpiece properly and to hold the saw firmly to prevent loss of control which could cause personal injury. Fig. 4 illustrates typical hand support of the saw.

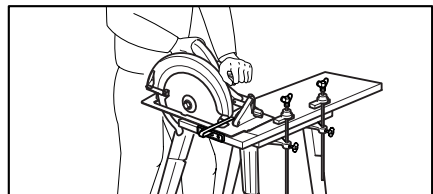

Fig. 4

17. Place the wider portion of the saw base on that part of the workpiece which is solidly supported, not on the section that will fall off when the cut is made. As examples, Fig. 5 illustrates the RIGHT way to cut off the end of a board, and Fig. 6 the WRONG way. If the workpiece is short or small,

clamp it down. **DO NOT TRY TO HOLD SHORT PIECES BY HAND!**

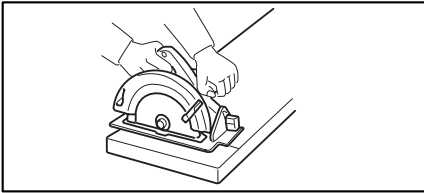

Fig. 5

extremely dangerous and can lead to serious accidents.

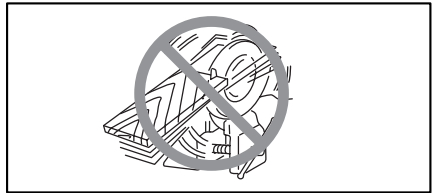

Fig. 7



Fig. 6

18. Never attempt to saw with the circular saw held upside down in a vise. This is

19. **WARNING:** Blade coasts to stop after switch is released. Contact with coasting blade can cause serious injury. Before setting the tool down after completing a cut, be sure that the lower (telescoping) guard has closed and the blade has come to a complete stop.

20. Some material contains chemicals which may be toxic. Take caution to prevent dust inhalation and skin contact. Follow material supplier safety data.

## SAVE THESE INSTRUCTIONS

**⚠ WARNING:**  
**MISUSE** or failure to follow the safety rules stated in this instruction manual may cause serious personal injury.

## SYMBOLS

USD301-1

The followings show the symbols used for tool.

V ..... volts

$n_0$  ..... no load speed

—|—|—| ..... direct current

.../min..... revolutions or reciprocation per minute

# IMPORTANT SAFETY INSTRUCTIONS FOR CHARGER & BATTERY CARTRIDGE

USC002-3

1. **SAVE THESE INSTRUCTIONS-** This manual contains important safety and operating instructions for battery charger.
2. Before using battery charger, read all instructions and cautionary markings on (1) battery charger, (2) battery, and (3) product using battery.
3. **CAUTION -** To reduce risk of injury, charge only MAKITA rechargeable batteries marked on the charger label. Other types of batteries may burst causing personal injury and damage.
4. Do not expose charger to rain or snow.
5. Use of an attachment not recommended or sold by the battery charger manufacturer may result in a risk of fire, electric shock, or injury to persons.
6. To reduce risk of damage to electric plug and cord, pull by plug rather than cord when disconnecting charger.
7. Make sure cord is located so that it will not be stepped on, tripped over, or otherwise subjected to damage or stress.
8. An extension cord should not be used unless absolutely necessary. Use of improper extension cord could result in a risk of fire and electric shock. If extension cord must be used, make sure:
  - a. That pins on plug of extension cord are the same number, size, and shape as those of plug on charger;
  - b. That extension cord is properly wired and in good electrical condition; and
  - c. That wire size is at least as large as the one specified in the table below.

Table 1: RECOMMENDED MINIMUM AWG SIZE FOR EXTENSION CORDS FOR BATTERY CHARGERS

Length of Cord (Feet)	25	50	100	150
AWG Size of Cord	18	18	18	16

9. Do not operate charger with damaged cord or plug - replace them immediately.
10. Do not operate charger if it has received a sharp blow, been dropped, or otherwise damaged in any way; take it to a qualified serviceman.
11. Do not disassemble charger or battery cartridge; take it to a qualified serviceman when service or repair is required. Incorrect reassembly may result in a risk of electric shock or fire.
12. To reduce risk of electric shock, unplug charger from outlet before attempting any maintenance or cleaning. Turning off controls will not reduce this risk.
13. The battery charger is not intended for use by young children or infirm persons without supervision.
14. Young children should be supervised to ensure that they do not play with the battery charger.
15. If operating time has become excessively shorter, stop operating immediately. It may result in a risk of overheating, possible burns and even an explosion.
16. If electrolyte gets into your eyes, rinse them out with clear water and seek medical attention right away. It may result in loss of your eyesight.



---

# ADDITIONAL SAFETY RULES FOR CHARGER & BATTERY CARTRIDGE

1. Do not charge Battery Cartridge when temperature is BELOW 10°C (50°F) or ABOVE 40°C (104°F).
2. Do not attempt to use a step-up transformer, an engine generator or DC power receptacle.
3. Do not allow anything to cover or clog the charger vents.
4. Do not short the battery cartridge:
  - (1) Do not touch the terminals with any conductive material.
  - (2) Avoid storing battery cartridge in a container with other metal objects such as nails, coins, etc.
  - (3) Do not expose battery cartridge to water or rain.
5. Do not store the tool and Battery Cartridge in locations where the temperature may reach or exceed 50°C (122°F).
6. Do not incinerate the Battery Cartridge even if it is severely damaged or is completely worn out. The battery cartridge can explode in a fire.
7. Be careful not to drop, shake or strike battery.
8. Do not charge inside a box or container of any kind. The battery must be placed in a well ventilated area during charging.

A battery short can cause a large current flow, overheating, possible burns and even a breakdown.

---

## SAVE THESE INSTRUCTIONS

---

## SYMBOLS

The following show the symbols used for the charger. Be sure that you understand their meaning before use.

 ..... Ready to charge

 ..... Charging

 ..... Charging complete

 ..... Delay charge (Cooling)

 ..... Defective battery

 ..... Conditioning

 ..... Cooling abnormality

# FUNCTIONAL DESCRIPTION

## ⚠ CAUTION:

- Always be sure that the tool is switched off and the battery cartridge is removed before adjusting or checking function on the tool.

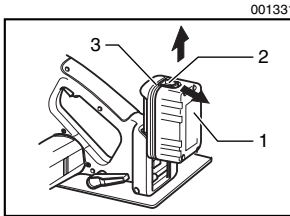

1. Battery cartridge
2. Button
3. Red part

## Installing or removing battery cartridge

- Always switch off the tool before insertion or removal of the battery cartridge.
- To remove the battery cartridge, withdraw it from the tool while sliding the button on the side of the cartridge.
- To insert the battery cartridge, align the tongue on the battery cartridge with the groove in the housing and slip it into place. Always insert it all the way until it locks in place with a little click. If you can see the red part on the upper side of the button, it is not locked completely. Insert it fully until the red part cannot be seen. If not, it may accidentally fall out of the tool, causing injury to you or someone around you.
- Do not use force when inserting the battery cartridge. If the cartridge does not slide in easily, it is not being inserted correctly.

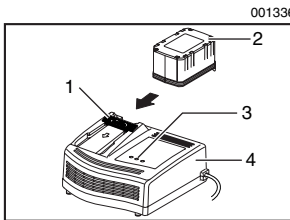

1. Terminal cover
2. Battery cartridge
3. Charging light
4. Battery charger

## Charging

1. Plug the battery charger into the proper AC voltage source. Two charging lights will flash in green color repeatedly.
2. Insert the battery cartridge into charger until it stops adjusting to the guide of charger. Terminal cover of charger can be opened with inserting and closed with pulling out the battery cartridge.
3. When the battery cartridge is inserted, the charging light color will change from green to red and charging will begin. The charging light will keep lighting up lit steadily during charging. One red charging light indicates charged condition in 0 - 80% and two red ones indicates 80 - 100%.
4. With finish of charge, the charging lights will change from two red ones to two green ones.
5. If you leave the battery cartridge in the charger after the charging cycle is complete, the charger will switch into its "trickle charge (maintenance charge)" mode which will last approximately 24 hours.

- 
6. After charging, unplug the charger from the power source.

**NOTE:**

- The battery charger is for charging Makita battery cartridge. Never use it for other purposes or for other manufacturer's batteries.
- When you charge a new battery cartridge or a battery cartridge which has not been used for a long period of time, it may not accept a full charge. This is a normal condition and does not indicate a problem. You can recharge the battery cartridge fully after discharging it completely and recharging a couple of times.
- If you charge a battery cartridge from a just operated tool or battery cartridge which has been left in a location exposed to direct sunlight for a long time, the charging light may flash in red color. If this occurs, wait for a while. Charging will begin after the battery cartridge is cooled by the cooling fan installed in the charger. When the temperature on battery is more than approx. 70°C, two charging lights may flash in red color, and when approx. 50°C - 70°C, one charging light in red color.
- If the charging light flashes alternately in green and red color, charging is not possible. The terminals on the charger or battery cartridge are clogged with dust or the battery cartridge is worn out or damaged.

**Cooling system**

- This charger is equipped with cooling fan for heated battery in order to enable the battery to prove its own performance. Sound of cooling air comes out during cooling, which means no trouble on the charger.
- Yellow light will flash for warning in the following cases.
  - Trouble on cooling fan
  - Incomplete cool down of battery, such as, being clogged with dustThe battery can be charged in spite of the yellow warning light. But the charging time will be longer than usual in this case.
- Check the sound of cooling fan, vent on the charger and battery, which can be sometime clogged with dust.
- The cooling system is in order although no sound of cooling fan comes out, if the yellow warning light will not flash.

- 
- Always keep clean the vent on charger and battery for cooling.
  - The products should be sent to repair or maintenance, if the yellow warning light will frequently flash.

### **Conditioning charge**

Conditioning charge can extend the life of battery by automatically searching the optimum charging condition for the batteries in every situations.

The battery employed in the following conditions repeatedly, will be worn out shortly, and yellow warning light may flash.

1. Recharge of battery with its high temperature
2. Recharge of battery with its low temperature
3. Recharge of full charged battery
4. Over-discharge of battery (continue to discharge battery in spite of down of power.)

The charging time of such battery is longer than usual.

### **Trickle charge (Maintenance charge)**

If you leave the battery cartridge in the charger to prevent spontaneous discharging after full charge, the charger will switch into its "trickle charge (maintenance charge)" mode and keep the battery cartridge fresh and fully charged.

### **Tips for maintaining maximum battery life**

1. Charge the battery cartridge before completely discharged.  
Always stop tool operation and charge the battery cartridge when you notice less tool power.
2. Never recharge a fully charged battery cartridge.  
Overcharging shortens the battery service life.
3. Charge the battery cartridge with room temperature at 10°C - 40°C (50°F - 104°F).  
Let a hot battery cartridge cool down before charging it.
4. Charge the Nickel Metal Hydride battery cartridge when you do not use it for more than six months.

001354

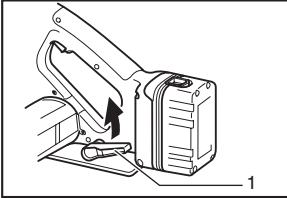

1. Lever

## Adjusting depth of cut

### ⚠ CAUTION:

- After adjusting the depth of cut, always tighten the lever securely.

Loosen the lever on the side of the rear handle and move the base up or down. At the desired depth of cut, secure the base by tightening the lever.

For cleaner, safer cuts, set cut depth so that no more than one blade tooth projects below workpiece. Using proper cut depth helps to reduce potential for dangerous KICKBACKS which can cause personal injury.

001370

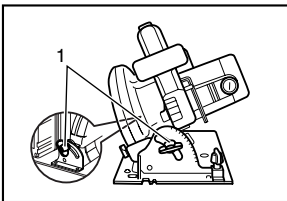

1. Clamping screw

## Bevel cutting

Loosen the clamping screws in front and back. Set for the desired angle ( $0^\circ - 50^\circ$ ) by tilting accordingly, then tighten the clamping screws securely. Use the  $45^\circ$  stopper when you do precise  $45^\circ$  angle cutting. Turn the lever clockwise fully for bevel cut ( $0^\circ - 45^\circ$ ) and turn it counterclockwise for  $0^\circ - 50^\circ$  bevel cuts.

001371

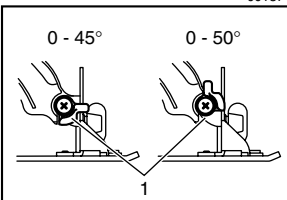

1. Stopper

## Sighting

For straight cuts, align the A position on the front of the base with your cutting line. For  $45^\circ$  bevel cuts, align the B position with it.

001389

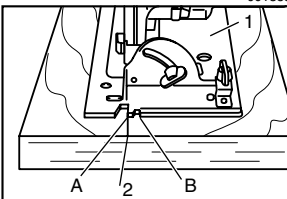

1. Base  
2. Cutting line

001410

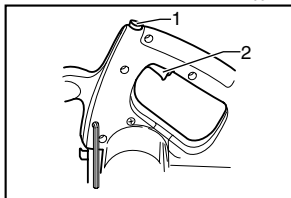

1. Lock-off button
2. Switch trigger

## Switch action

### ⚠ CAUTION:

- Before inserting the battery cartridge into the tool, always check to see that the switch trigger actuates properly and returns to the “OFF” position when released.

To prevent the switch trigger from being accidentally pulled, a lock-off button is provided. To start the tool, push in the lock-off button and pull the switch trigger. Release the switch trigger to stop.

## Electric brake

This tool is equipped with an electric blade brake. If the tool consistently fails to quickly stop blade after switch trigger release, have tool serviced at a Makita service center.

The blade brake system is not a substitute for lower guard. NEVER USE TOOL WITHOUT A FUNCTIONING LOWER GUARD. SERIOUS PERSONAL INJURY CAN RESULT.

## ASSEMBLY

### ⚠ CAUTION:

- Always be sure that the tool is switched off and the battery cartridge is removed before carrying out any work on the tool.

001431

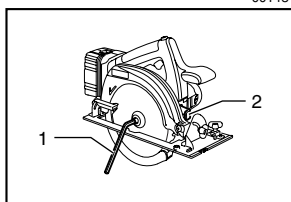

1. Hex wrench
2. Shaft lock

## Removing or installing saw blade

### ⚠ CAUTION:

- Be sure the blade is installed with teeth pointing up at the front of the tool.
- Use only the Makita wrench to install or remove the blade.

To remove the blade, press the shaft lock so that the blade cannot revolve and use the wrench to loosen the hex bolt counterclockwise. Then remove the hex bolt, outer flange and blade.

001448

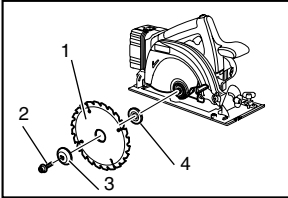

1. Saw blade
2. Hex bolt
3. Outer flange
4. Inner flange

To install the blade, follow the removal procedure in reverse. **BE SURE TO TIGHTEN THE HEX BOLT CLOCKWISE SECURELY.**

When changing blade, make sure to also clean upper and lower blade guards of accumulated sawdust. Such efforts do not, however, replace the need to check lower guard operation before each use.

001456

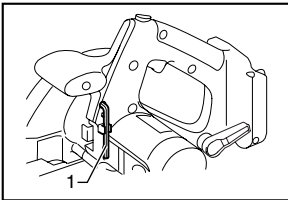

1. Hex wrench

### Hex wrench storage

When not in use, store the hex wrench as shown in the figure to keep it from being lost.

## OPERATION

### ⚠ CAUTION:

- Always insert the battery cartridge all the way until it locks in place. If you can see the red part on the upper side of the button, it is not locked completely. Insert it fully until the red part cannot be seen. If not, it may accidentally fall out of the tool, causing injury to you or someone around you.
- Be sure to move the tool forward in a straight line gently. Forcing or twisting the tool will result in overheating the motor and dangerous kickback, possibly causing severe injury.
- If the tool is operated continuously until the battery cartridge has discharged, allow the tool to rest for 15 minutes before proceeding with a fresh battery.

001474

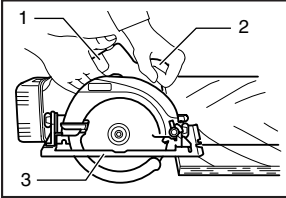

1. Rear handle
2. Front grip
3. Base

Hold the tool firmly. The tool is provided with both a front grip and rear handle. Use both to best grasp the tool. If both hands are holding saw, they cannot be cut by the blade. Set the base on the workpiece to be cut without the blade making any contact. Then turn the tool on and wait until the blade attains full speed. Now simply move the tool forward over the workpiece surface, keeping it flat and advancing smoothly until the sawing is completed.

To get clean cuts, keep your sawing line straight and your speed of advance uniform. If the cut fails to properly follow your intended cut line, do not attempt to turn or force the tool back to the cut line. Doing so may bind the blade and lead to dangerous kickback and possible serious injury. Release switch, wait for blade to stop and then withdraw tool. Realign tool on new cut line, and start cut again. Attempt to avoid positioning which exposes operator to chips and wood dust being ejected from saw. Use eye protection to help avoid injury.

001493

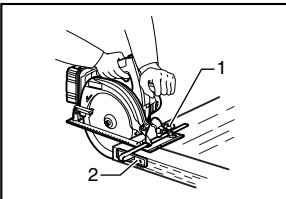

1. Clamp screw
2. Rip fence (Guide rule)

### Rip fence (Guide rule)

The handy rip fence allows you to do extra-accurate straight cuts. Simply slide the rip fence up snugly against the side of the workpiece and secure it in position with the screw on the front of the base. It also makes repeated cuts of uniform width possible.

## MAINTENANCE

### ⚠ CAUTION:

- Always be sure that the tool is switched off and the battery cartridge is removed before attempting to perform inspection or maintenance.



001503

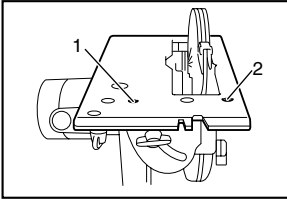

1. Adjusting screw for 90°
2. Adjusting screw for 45°

## Adjusting for accuracy of 90° and 45° cut (vertical and 45° cut)

This adjustment has been made at the factory. But if it is off, adjust the adjusting screws with a hex wrench while inspecting 90° or 45° the blade with the base using a triangular rule or square rule, etc.

001512

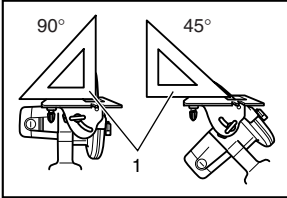

1. Triangular rule

001145

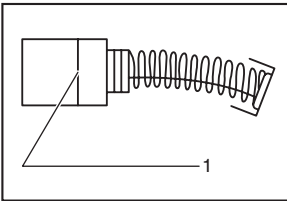

1. Limit mark

## Replacing carbon brushes

Remove and check the carbon brushes regularly. Replace when they wear down to the limit mark. Keep the carbon brushes clean and free to slip in the holders. Both carbon brushes should be replaced at the same time. Use only identical carbon brushes.

001527

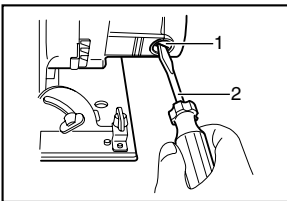

1. Brush holder cap
2. Screwdriver

Use a screwdriver to remove the brush holder caps. Take out the worn carbon brushes, insert the new ones and secure the brush holder caps.

After replacing brushes, insert the battery cartridge into the tool and break in brushes by running tool with no load for about 1 minute. Then check the tool while running and electric brake operation when releasing the switch trigger. If electric brake is not working well, ask your local Makita service center for repair.

To maintain product SAFETY and RELIABILITY, repairs, any other maintenance or adjustment should be performed by Makita Authorized or Factory Service Centers, always using Makita replacement parts.

---

## ACCESSORIES

**⚠ CAUTION:**

- These accessories or attachments are recommended for use with your Makita tool specified in this manual. The use of any other accessories or attachments might present a risk of injury to persons. Only use accessory or attachment for its stated purpose.

If you need any assistance for more details regarding these accessories, ask your local Makita service center.

- Carbide-tipped saw blades

Combination	General purpose blade for fast and smooth rip, crosscuts and miters.
-------------	--

- Rip fence (Guide rule)
- Hex wrench 2.5
- Hex wrench 5
- Plastic case

---

# Memo

---

---

---

---

---

---

---

---

---

---

---

---

---

---

---

---

---

---

---

---

---

---

---



Cut



**Makita Canada Inc.**  
**1950 Forbes Street,**  
**Whitby, Ontario**  
**L1N 7B7**

Fold

# Your answers to the following questions are appreciated.

**1. This product was purchased from?**

- Hardware/lumber Store     Industrial Supply  
 Tool Distributor         Other (            )

**3. How did you first learn of Makita Power Tools?**

- Magazine/Newspaper     Catalog  
 From dealer                 Other (            )  
 Store display

**2. Use of the product is intended for?**

- Construction trade     Home maintenance  
 Industrial maintenance     Other (            )

**4. Most favored points are?**

- Design                       Makita Brand  
 Features                     Power  
 Size                          Other (            )  
 Price

**5. Any comments?**

---



---



---



---



---

## Certificate of Warranty Mail to Makita

Date Purchased

Month	Day	Year 20
<input type="text"/>	<input type="text"/>	<input type="text"/>

Model No.
Serial No.

Initial Last Name

Male    Female    Single    Married

<input type="text"/>	<input type="text"/>	<input type="text"/>	<input type="text"/>	<input type="text"/>	<input type="text"/>	<input type="text"/>	<input type="text"/>	<input type="text"/>	<input type="text"/>	<input type="text"/>	<input type="text"/>	<input type="text"/>	<input type="text"/>	<input type="text"/>	<input type="text"/>	<input type="text"/>
----------------------	----------------------	----------------------	----------------------	----------------------	----------------------	----------------------	----------------------	----------------------	----------------------	----------------------	----------------------	----------------------	----------------------	----------------------	----------------------	----------------------

Street Address

City

Province

Postal Code

AGE:	<input type="checkbox"/> Under 19	<input type="checkbox"/> 20-29	<input type="checkbox"/> 30-39	<input type="checkbox"/> 40-49	<input type="checkbox"/> Over 50
------	-----------------------------------	--------------------------------	--------------------------------	--------------------------------	----------------------------------

Occupation:

Dealer's Name & Address:

---

# Factory Service Centres

<b>Head Office:</b>	1950 Forbes St., Whitby, Ontario, L1N 7B7 (905) 571 - 2200	1-800-263-3734
<b>Regional Office:</b>	11771 Hammersmith Way, Richmond B.C. V7A 5H6 (604) 272 - 3104	1-800-663-0909
<b>Regional Office:</b> (Montreal)	6389 boul, Couture, St. Leonard, Quebec H1P 3J5 (514) 323 - 1223	1-800-361-7049
<b>Dartmouth:</b>	202 Brownlow Avenue Dartmouth, N.S., B3B 1T5 (902) 468 - 7064	1-888-625-4821
<b>Ville St. Laurent:</b> (Montreal)	1140 Rue Bégin, Ville St. Laurent, Quebec H4R 1X1 (514) 745 - 5025	1-888-745-5025
<b>Les Saules:</b> (Quebec)	1200 St. Jean Baptiste, Unit 106, Les Saules, Quebec, G2E 5E8 (418) 871 - 5720	1-800-663-5757
<b>Nepean:</b> (Ottawa)	203 Colonnade Road, Unit #6, Nepean, Ontario K2E 7K3 (613) 224 - 5022	1-888-560-2214
<b>Whitby:</b>	1950 Forbes St., Whitby, Ontario, L1N 7B7 (905) 571 - 2200	1-800-263-3734
<b>London:</b>	317 Adelaide St. S., Unit 117, London, Ontario, N5Z 3L3 (519) 686 - 3115	1-800-571-0899
<b>Mississauga:</b>	6350 Tomken Rd., Unit 8, Mississauga, Ontario, L5T 1Y3 (905) 670 - 7255	1-800-221-9811
<b>Calgary:</b>	#8-6115 Fourth St. S.E., Calgary Alberta, T2H 2H9 (403) 243 - 3995	1-800-267-0445
<b>Edmonton:</b>	11614-149 Street, Edmonton, Alberta, T5M 3R3 (780) 455 - 6644	1-888-455-6644
<b>Richmond:</b>	11771 Hammersmith Way, Richmond, B.C., V7A 5H6 (604) 272 - 3104	1-800-663-0909
<b>Coquitlam:</b>	2131 Hartley Ave., #103 Coquitlam, B.C. V3K 2Z3 (604) 525 - 7434	1-800-266-7738
<b>Winnipeg:</b>	1670 St. James Street, Winnipeg, Manitoba, R3H 0L3 (204) 694 - 0402	1-800-550-5073
<b>Saskatoon:</b>	206A-2750 Faithful Avenue Saskatoon, Saskatchewan, S7K 6M6 (306) 931 - 0111	1-888-931-0111

For the authorized service centre nearest you please refer to the local yellow pages directory under "tools" or contact our customer service department (Tel) 1-800-263-3734

## When you need service...

- Explain the problem in a letter
- Enclose the letter with the tool
- Package carefully and send prepaid to the nearest Makita factory or authorized service centre

## CUSTOMER RECORD

DATE  
PURCHASED: \_\_\_\_\_

DEALER'S NAME  
& ADDRESS: \_\_\_\_\_  
\_\_\_\_\_

MODEL NO.: \_\_\_\_\_

SERIAL NO.: \_\_\_\_\_

# MAKITA LIMITED ONE YEAR WARRANTY

## Warranty Policy

Every Makita tool is thoroughly inspected and tested before leaving the factory. It is warranted to be free of defects from workmanship and materials for the period of ONE YEAR from the date of original purchase. Should any trouble develop during this one year period, return the COMPLETE tool, freight prepaid, to one of Makita's Factory or Authorized Service Centres. If inspection shows the trouble is caused by defective workmanship or material, Makita will repair (or at our option, replace) without charge.

This Warranty does not apply:

- where normal maintenance is required,
- repairs have been made or attempted by others,
- the tool has been abused, misused or improperly maintained,
- alterations have been made to the tool.

IN NO EVENT SHALL MAKITA BE LIABLE FOR ANY INDIRECT, INCIDENTAL OR CONSEQUENTIAL DAMAGES FROM THE SALE OR USE OF THE PRODUCT. THIS DISCLAIMER APPLIES BOTH DURING AND AFTER THE TERM OF THIS WARRANTY.

"The Makita Warranty is the only and the entire written warranty given by Makita for the Makita tools. No dealer or his agent or employee is authorized to extend or enlarge upon this warranty by any verbal or written statement or advertisement."

MAKITA DISCLAIMS LIABILITY FOR ANY IMPLIED WARRANTIES INCLUDING IMPLIED WARRANTIES OF "MERCHANTABILITY" AND FITNESS FOR A SPECIFIC PURPOSE," AFTER THE ONE YEAR TERM OF THIS WARRANTY.

"This Warranty gives you specific rights. The provisions contained in this warranty are not intended to limit, modify, take away from, disclaim or exclude any warranties set forth in any provincial legislation. To the extent required by law, the provisions in any provincial or federal legislation with respect to warranties take precedence over the provisions in this warranty."

**Makita Corporation of America**

2650 Buford Hwy., Buford, GA 30518



## Free Manuals Download Website

<http://myh66.com>

<http://usermanuals.us>

<http://www.somanuals.com>

<http://www.4manuals.cc>

<http://www.manual-lib.com>

<http://www.404manual.com>

<http://www.luxmanual.com>

<http://aubethermostatmanual.com>

Golf course search by state

<http://golfingnear.com>

Email search by domain

<http://emailbydomain.com>

Auto manuals search

<http://auto.somanuals.com>

TV manuals search

<http://tv.somanuals.com>