



Makita Circular Saw

185 mm (7 1/4") MODEL SR1800

INSTRUCTION MANUAL

Circular Saw & Standard Equipment

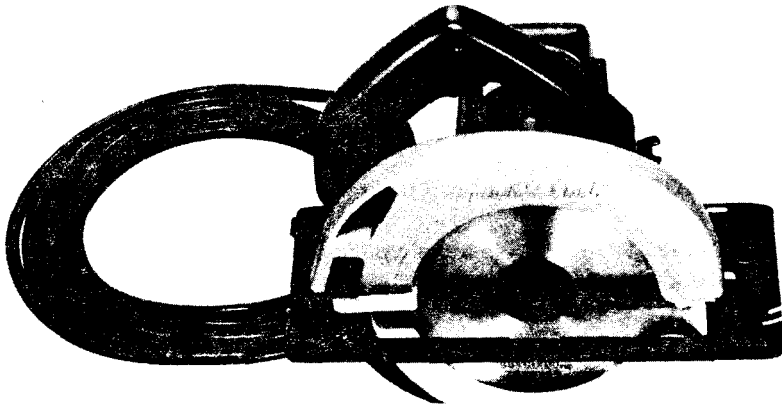

- ① Tool body
- ② Guide rule
- ③ Socket wrench (9)



Specifications

Blade diameter	Max. cutting depth		Continuous rating (input)	No load speed	Overall length	Net weight	Power supply cord
	45°	90°					
185 mm (7-1/4")	45 mm (1-3/4")	65 mm (2-1/2")	1,150 W	4,500 R/min.	290 mm (11-3/8")	4.2 kg (9.3 lbs)	2.5 m (8.2 ft.)

* Manufacturer reserves the right to change specifications of parts and accessories without notice.

* Note: Specifications of parts and accessories may vary from country to country.

BEFORE CONNECTING YOUR TOOL TO A POWER SOURCE

Be sure you have read all GENERAL POWER TOOL SAFETY RULES

GENERAL SAFETY PRECAUTIONS

1. **KEEP WORK AREA CLEAN.** Cluttered areas and benches invite accidents.
2. **AVOID DANGEROUS ENVIRONMENT.** Don't use power tools in damp or wet locations. Keep work area well lit. Do not expose power tool in rain.
3. **KEEP CHILDREN AWAY.** All visitors should be kept safe distance from work area.
4. **STORE IDLE TOOLS.** When not in use, tools should be stored in dry, high or locked-up place—out of the reach of children.
5. **DON'T FORCE TOOL.** It will do the job better and safer at the rate for which it was designed.
6. **USE RIGHT TOOL.** Don't force small tool or attachment to do the job of a heavy-duty tool.
7. **WEAR PROPER APPAREL.** No loose clothing or jewelry to get caught in moving parts. Rubber gloves and footwear are recommended when working outdoors.
8. **USE SAFETY GLASSES.** Use safety glasses with most tools. Also face or dust mask if cutting operation is dusty.
9. **DON'T ABUSE CORD.** Never carry tool by cord or yank it to disconnect from receptacle. Keep cord from heat, oil, and sharp edges.
10. **SECURE WORK.** Use clamps or vise to hold work. It's safer than using your hand and it frees both hands to operate tool.
11. **DON'T OVERREACH.** Keep proper footing and balance at all times.
12. **MAINTAIN TOOLS WITH CARE.** Keep tools sharp and clean for best and safest performance. Follow instructions for lubricating and changing accessories.
13. **DISCONNECT TOOLS.** When not in use; before servicing; when changing blade or adjusting guides.
14. **REMOVE ADJUSTING KEYS AND WRENCHES.** Form habit of checking to see that keys and adjusting wrenches are removed from tool before turning it on.
15. **AVOID ACCIDENTAL STARTING.** Don't carry plugged-in tool with finger on switch. Be sure switch is OFF when plugging in.
16. **OUTDOOR USE EXTENSION CORDS.** When tool is used outdoors, use only extension cords suitable for use outdoors and so marked.
17. **Keep Guards in Place and in Working Order.**
18. **Keep Blades Sharp.**
19. **Keep Hands Away from Cutting Area.**
20. **REPLACEMENT PARTS.** When servicing use only identical replacement parts.

PRELIMINARY INSTRUCTIONS

Your electric tool is precision built and manufactured to satisfy the highest standards. For maximum performance, long tool life, and your safety, follow these instructions carefully.

VOLTAGE WARNING: Before connecting the tool to a power source (receptacle, outlet, etc.) be sure the voltage supplied is the same as that specified on the nameplate of the tool. A power source with voltage greater than that specified for the tool can result in **SERIOUS INJURY** to the user – as well as damage to the tool. If in doubt, **DO NOT PLUG IN THE TOOL**. Using a power source with voltage less than the nameplate rating is harmful to the motor.

HOW TO USE

1. Planing depth (cutting volume) may be adjusted as desired by simply turning the knob (front grip) on the front of the power planer.

2. To start the tool, simply pull the trigger. Release the trigger to stop. Models with a lock button on the handle may be run continuously without keeping your finger on the trigger. To lock the trigger in the ON position, first pull the trigger and then depress the lock button on the handle with your thumb. To stop the tool from the lock position, just pull the trigger again and release it.

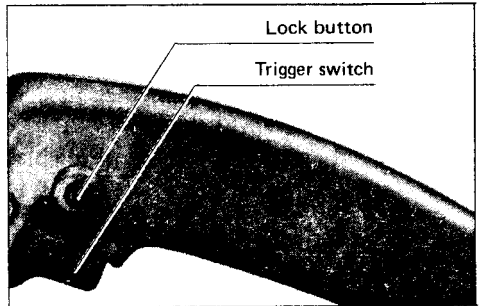

Fig. 1

3. After you switch on the tool by pulling the trigger, wait until the planer is running at top speed before bringing it into contact with the wood. Planing will be easier if you incline the workpiece in stationary fashion, so that you can plane somewhat downhill.

4. **Starting & Finishing Planing Work**
First, rest the tool front shoe flat upon the work surface. Switch on, then move the planer gently forward. Apply pressure to tool as indicated (photo), at start and end of planing.



Fig. 2

5. **For Fine Finishes**

The speed and volume of planing determine the kind of finish. The power planer keeps cutting at a speed that will not result in jamming by chips. For rough cutting, the volume is upped, while for a good finish you should cut less and advance the tool more slowly.

REPLACING INSTALLING PLANER BLADES

After unplugging the tool, you may remove the planer blades on the tool drum by unscrewing the three installation bolts with the socket wrench provided. The clamp plate comes off together with the blades. See Photo.

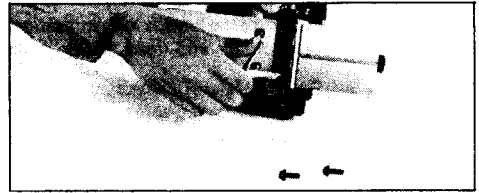

Fig. 3

When you install new or sharpened blades, first clean out all chips or foreign matter adhering to the drum or blades. Use blades of the same dimensions and weight, or drum oscillation/vibration will result, causing poor planing action and, eventually, tool breakdown.

Screw the blade onto the adjust plate, slip it into the groove on the drum, then fit the blade clamp on over it. Fasten with hex flange hd. bolt. See diagram at above.

When properly installed, the side of the blade should be flush with the outside edge of the front and back shoes.

For rabbeting, the edge of the blade should be made to protrude outside slightly (0.3 mm – 0.6 mm : 1/64" – 1/32"). Otherwise, nicks and generally poor rabbeting results.

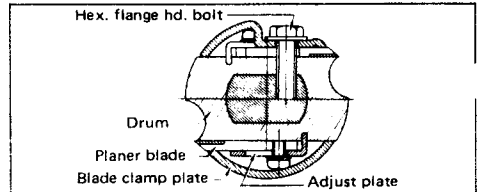

Fig. 4

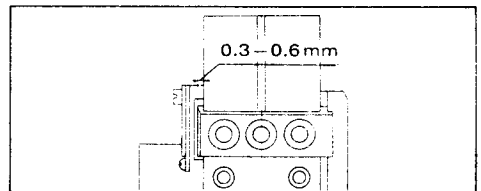
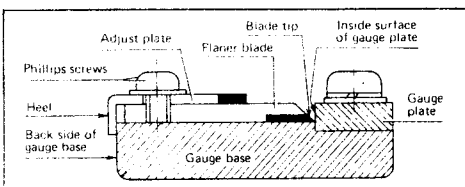

Fig. 5

Using blade gauge for even blade setting

Although the blade protrusion for desired cutting depth is easily obtained by turning the front knob, the setting of the blade itself in relation to the work may require adjustment. This is done conveniently with the blade gauge provided.

First, remove the blade from the tool by unscrewing the hex bolts. Now set the blade on the gauge base so that the cutting edge of the blade is perfectly flush with the inside surface of the gauge plate. Loosen the screws on the adjust plate (if they are not already so), then simply press in the heel of the adjust plate flush with the back side of the gauge base and tighten the two Phillips screws on top. This insures that your blade tip will be set properly when remounted in the tool so as to provide perfectly even planing.



- (1) Set blade tip flush with inside surface of gauge plate.
- (2) Press in heel of adjust plate flush with back side of gauge base.
- (3) Tighten two Phillips screws to hold blade in place.

Fig. 6

FOR THE CORRECT PLANER BLADE SETTING

Your planing surface will end up unsmooth and not level, unless the blade is set properly and securely. The blade must be mounted so that the cutting edge is absolutely level, that is, parallel to the surface of the rear base. Below are some examples of proper and improper settings.

(A) Front base (Movable shoe)

(B) Rear base (Stationary shoe)

Correct setting

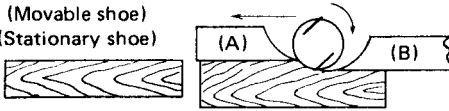

Although this side view cannot show it, the edges of the blades run perfectly parallel to the rear base surface.

Nicks in surface



Cause: One or both blades fails to have edge parallel to rear base line.

Gouging at start

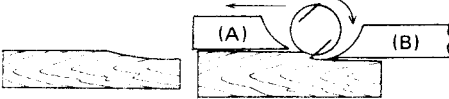

Cause: One or both blade edges fails to protrude enough in relation to rear base line.

Gouging at end

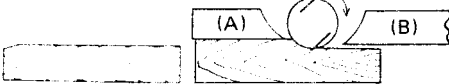

Cause: One or both blade edges protrudes too far in relation to rear base line.

SHARPENING PLANER BLADES

Although a power planer considerably outperforms an ordinary hand plane, by the same token the blades become dull faster. Always keep your blades sharp for the best performance possible. Use the sharpening holder (photo) to remove nicks and produce a fine edge.

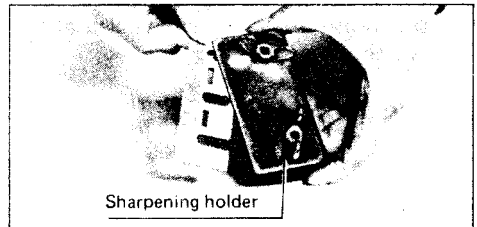

Fig. 7

First, loosen the 2 wing nuts on the holder and insert blades A and B as in figure at right, so that they contact side C and D. Then tighten wing nuts.

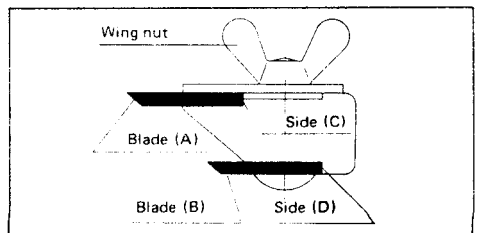

Fig. 8

Immerse dressing stone in water for 2 or 3 minutes before sharpening. Grip the holder so that blades both contact the dressing stone for simultaneous sharpening at the same angle. Stock removal is possible up to 7.5 mm (5/16"). Blades may be used down to 24.5 mm (1").

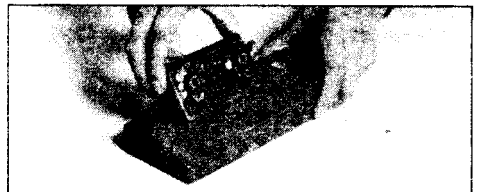

Fig. 9

USE OF NOZZLE ASSEMBLY

Use of the special nozzle assembly (accessory attachment) will prevent chip scatter, making for a clean work area.

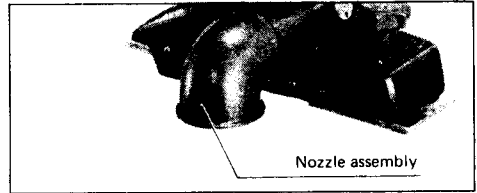

Fig. 10

ATTACHING NOZZLE ASSEMBLY

The nozzle assembly may be attached after the chip cover on the tool body is removed. When slipping on the assembly, fit the pin on it into the rear cover hole. Use the chip cover screws to fasten it in place.

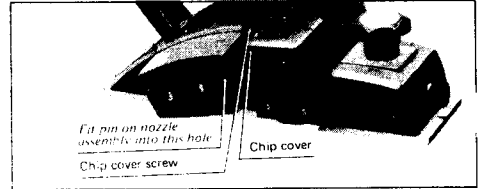

Fig. 11

MAINTENANCE

• Carbon brushes

Replace carbon brushes when they wear down to about 5 mm (3/16") or sparking will occur.

Both brushes should be changed at the same time.

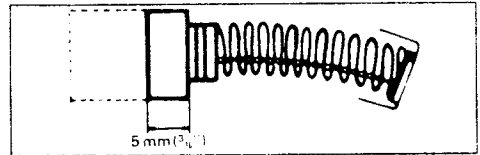

Fig. 12

ACCESSORIES CAUTION: The use of any other accessories not specified in this manual might be hazardous.

• Replacement blades

Width: 82 mm (3-1/4")
Part No. 731001-4



• Planer blades

(Material: Tungsten-carbide)
Width: 82 mm (3-1/4")
Part No. 731201-6



• Guide rule

Part No. 164371-0



• Blade gauge assembly

Part No. 123062-2



• Sharpening holder assembly

Part No. 123004-6



• Dressing stone

Part No. 741802-2



• Planer stand

Part No. 122125-1



• Nozzle assembly

Part No. 122194-2



• Socket wrench

Part No. 782209-3

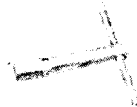

• Screwdriver

Part No. 783002-8



• Hex flange hd. bolt

Part No. 251609-3





185 mm (7 1/4") CIRCULAR SAW Model SR1800

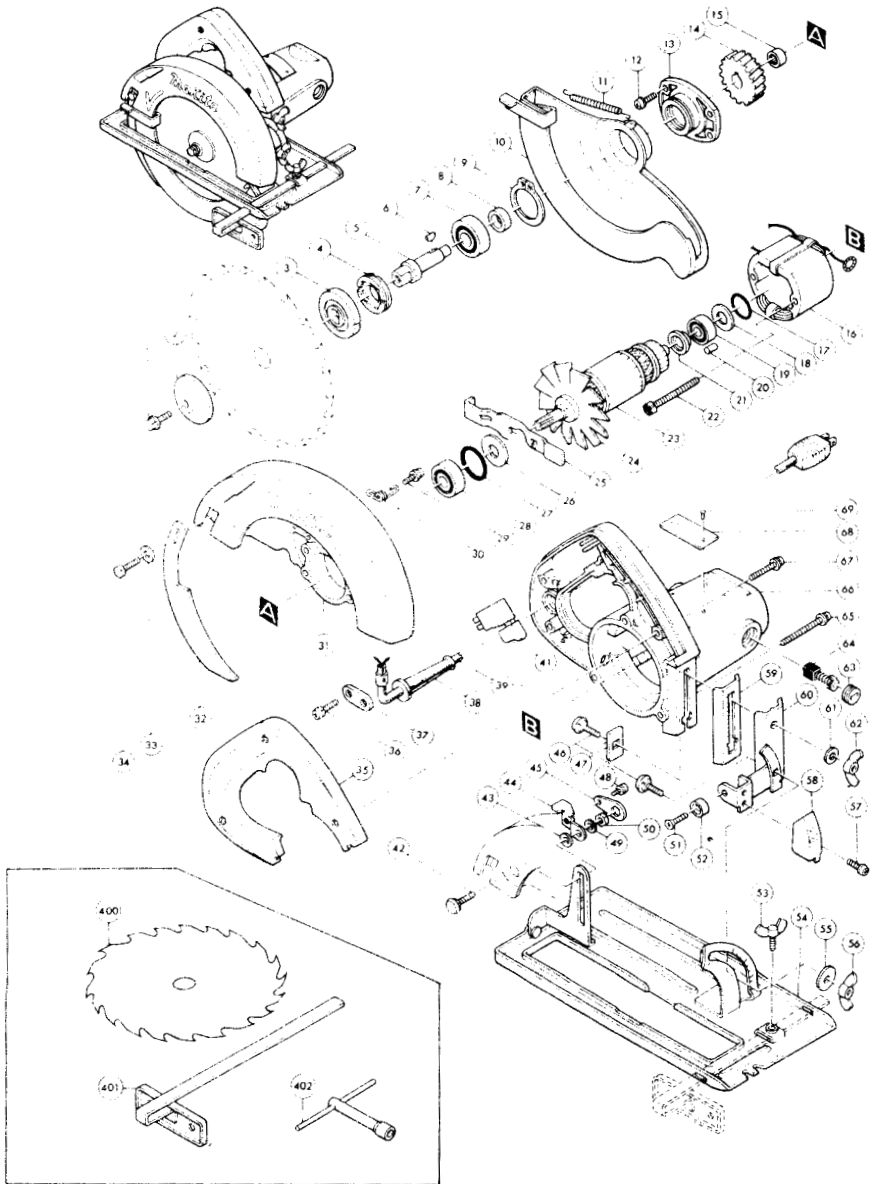

ITEM NO.	NO USED	DESCRIPTION	ITEM NO.	NO. USED	DESCRIPTION
MACHINE			MACHINE		
1	1	H. F. H. Bolt M6x17	41	1	Switch
2	1	Outer Flange 45			Single Pole (Without Lock Button) SGE115CDY (For U.S.A.)
3	1	Inner Flange 45			Single Pole (With Squared Washer & Without Lock Button) GPAH-4 (For Canada)
4	1	Bearing Retainer 19-33			C. S. N. Bolt M6x20
5	1	Spindle	42	1	F Washer 6
6	1	Woodruff Key 4	43	1	Lever Plate
7	1	Ball Bearing 6201LLB	44	1	Lock Plate
8	1	Ring 12	45	1	C. S. N. Bolt M6x20
9	1	Retaining Ring S 35	46	2	Plate
10	1	Safety Cover	47	1	P. H. Screw M4x6 (With Washer)
11	1	Tension Spring 4	48	1	F Washer 6
12	4	P. H. Screw M4x16 (With Washer)	49	1	H Nut M6
13	1	Bearing Box	50	1	C. H. Screw M5x20
14	1	Helical Gear 51	51	1	Rubber Sleeve 6
15	1	Needle Bearing B10	52	1	T. Screw M5x8
16	1	FIELD ASSEMBLY (With Garter Spring x 2)	53	1	BASE ASSEMBLY (Assembled Items 53 & 54)
17	1	O Ring 18			Base
18	1	F Washer 14	54	1	F Washer 6
19	1	Ball Bearing 608LLB	55	1	W Nut M6
20	1	Rubber Pin 4	56	1	P. H. Screw M4x8 (With Washer)
21	1	Insulation Washer	57	2	Front Guard
22	2	H. Bolt M5x60 (With Washer)	58	1	Slide Plate
23	1	ARMATURE ASSEMBLY (Assembled Items 19, 21, 23 & 24)	59	1	Angular Plate
24	1	Fan 86	60	1	F Washer 6
25	1	Spindle Lock	61	1	W Nut M6
26	1	F Washer 10	62	1	Brush Holder Cap
27	1	O Ring 30	63	2	Carbon Brush CB-101
28	1	Ball Bearing 6200LLB	64	2	P. H. Screw M5x45 (With Washer)
29	1	P. H. Screw M4x14 (With Washer)	65	3	Motor Housing (With Brush Holder x 2 & S Screw M5x8 x 2)
30	1	Torsion Spring 6	66	1	P. H. Screw M4x28 (With Washer)
31	1	Blade Case	67	3	Name Plate
32	1	Folding Knife	68	1	Rivet 0-3
33	1	F Washer 6	69	2	
34	1	H. Bolt M6x16			ACCESSORIES
35	1	Handle Cover	400	1	Chisel Tooth Combination Saw Blade 185
36	2	P. H. Screw M4x18 (With Washer)	401	1	Guide Rule
37	1	Strain Relief	402	1	Socket Wrench 9
38	1	Cord Guard			
39	1	CORD ASSEMBLY (Assembled Cord, Plug & Cord Guard)			



Makita Electric Works, Ltd.

Anjo, Aichi, Japan

PRINTED IN JAPAN
1981-1-N

Free Manuals Download Website

<http://myh66.com>

<http://usermanuals.us>

<http://www.somanuals.com>

<http://www.4manuals.cc>

<http://www.manual-lib.com>

<http://www.404manual.com>

<http://www.luxmanual.com>

<http://aubethermostatmanual.com>

Golf course search by state

<http://golfingnear.com>

Email search by domain

<http://emailbydomain.com>

Auto manuals search

<http://auto.somanuals.com>

TV manuals search

<http://tv.somanuals.com>