

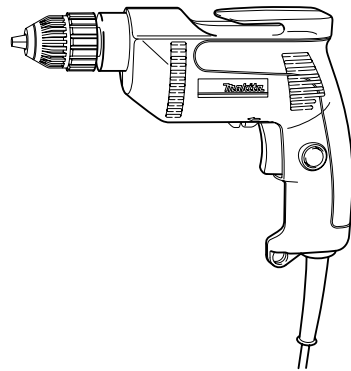

Drill

10 mm (3/8")
MODEL 6408



003000



I N S T R U C T I O N M A N U A L

⚠ WARNING:

For your personal safety, READ and UNDERSTAND before using.
SAVE THESE INSTRUCTIONS FOR FUTURE REFERENCE.

www.makitatools.com

SPECIFICATIONS

Model		6408
Capacities	Steel	10 mm (3/8")
	Wood	25 mm (1")
No load speed (RPM)		0 - 2,500/min.
Overall length		261 mm (10-9/32")
Net weight		1.4 kg (3.1 lbs)

- Manufacturer reserves the right to change specifications without notice.
- Specifications may differ from country to country.

GENERAL SAFETY RULES

USA002-2

(For All Tools)

⚠ WARNING:

Read and understand all instructions. Failure to follow all instructions listed below, may result in electric shock, fire and/or serious personal injury.

SAVE THESE INSTRUCTIONS

Work Area

1. **Keep your work area clean and well lit.** Cluttered benches and dark areas invite accidents.
2. **Do not operate power tools in explosive atmospheres, such as in the presence of flammable liquids, gases, or dust.** Power tools create sparks which may ignite the dust or fumes.
3. **Keep bystanders, children, and visitors away while operating a power tool.** Distractions can cause you to lose control.
4. **Double insulated tools are equipped with a polarized plug (one blade is wider than the other.) This plug will fit in a polarized outlet only one way. If the plug does not fit fully in the outlet, reverse the plug. If it still does not fit, contact a qualified electrician to install a polarized outlet. Do not change the plug in any way.** Double insulation  eliminates the need for the three wire grounded power cord and grounded power supply system.
5. **Avoid body contact with grounded surfaces such as pipes, radiators, ranges and refrigerators.** There is an increased risk of electric shock if your body is grounded.

Electrical Safety

6. **Do not expose power tools to rain or wet conditions.** Water entering a power tool will increase the risk of electric shock.
7. **Do not abuse the cord. Never use the cord to carry the tools or pull the plug from an outlet. Keep cord away from heat, oil, sharp edges or moving parts. Replace damaged cords immediately.** Damaged cords increase the risk of electric shock.
8. **When operating a power tool outside, use an outdoor extension cord marked “W-A” or “W”.** These cords are rated for outdoor use and reduce the risk of electric shock.

Personal Safety

9. **Stay alert, watch what you are doing and use common sense when operating a power tool. Do not use tool while tired or under the influence of drugs, alcohol, or medication.** A moment of inattention while operating power tools may result in serious personal injury.
10. **Dress properly. Do not wear loose clothing or jewelry. Contain long hair. Keep your hair, clothing, and gloves away from moving parts.** Loose clothes, jewelry, or long hair can be caught in moving parts.
11. **Avoid accidental starting. Be sure switch is off before plugging in.** Carrying tools with your finger on the switch or plugging in tools that have the switch on invites accidents.
12. **Remove adjusting keys or wrenches before turning the tool on.** A wrench or a key that is left attached to a rotating part of the tool may result in personal injury.
13. **Do not overreach. Keep proper footing and balance at all times.** Proper footing and balance enables better control of the tool in unexpected situations.
14. **Use safety equipment. Always wear eye protection.** Dust mask, non-skid safety shoes, hard hat, or hearing protection must be used for appropriate conditions. Ordinary eye or sun glasses are NOT eye protection.

Tool Use and Care

15. **Use clamps or other practical way to secure and support the workpiece to a stable platform.** Holding the work by hand or

against your body is unstable and may lead to loss of control.

16. **Do not force tool. Use the correct tool for your application.** The correct tool will do the job better and safer at the rate for which it is designed.
17. **Do not use tool if switch does not turn it on or off.** Any tool that cannot be controlled with the switch is dangerous and must be repaired.
18. **Disconnect the plug from the power source before making any adjustments, changing accessories, or storing the tool.** Such preventive safety measures reduce the risk of starting the tool accidentally.
19. **Store idle tools out of reach of children and other untrained persons.** Tools are dangerous in the hands of untrained users.
20. **Maintain tools with care. Keep cutting tools sharp and clean.** Properly maintained tools with sharp cutting edges are less likely to bind and are easier to control.
21. **Check for misalignment or binding of moving parts, breakage of parts, and any other condition that may affect the tools operation. If damaged, have the tool serviced before using.** Many accidents are caused by poorly maintained tools.
22. **Use only accessories that are recommended by the manufacturer for your model.** Accessories that may be suitable for one tool, may become hazardous when used on another tool.

SERVICE

23. **Tool service must be performed only by qualified repair personnel.** Service or maintenance performed by unqualified personnel could result in a risk of injury.
24. **When servicing a tool, use only identical replacement parts. Follow instructions in the Maintenance section of this manual.** Use of unauthorized parts or failure to follow Maintenance instructions may create a risk of electric shock or injury.

USE PROPER EXTENSION CORD: Make sure your extension cord is in good condition. When using an extension cord, be sure to use one heavy enough to carry the current your product will draw. An undersized cord will cause a drop in line voltage resulting in loss of power and overheating. Table 1 shows the correct size to use depending on cord length and nameplate ampere rating. If in doubt, use the next heavier gage. The smaller the gage number, the heavier the cord.

Table 1: Minimum gage for cord

Ampere Rating		Volts	Total length of cord in feet			
		120 V	25 ft.	50 ft.	100 ft.	150 ft.
More Than	Not More Than	AWG				
0	6		18	16	16	14
6	10		18	16	14	12
10	12		16	16	14	12
12	16		14	12	Not Recommended	

SPECIFIC SAFETY RULES

USB001-2

DO NOT let comfort or familiarity with product (gained from repeated use) replace strict adherence to drill safety rules. If you use this tool unsafely or incorrectly, you can suffer serious personal injury.

1. Hold tool by insulated gripping surfaces when performing an operation where the cutting tools may contact hidden wiring or its own cord. Contact with a "live" wire will make exposed metal parts of the tool "live" and shock the operator.
2. Always be sure you have a firm footing. Be sure no one is below when using the tool in high locations.
3. Hold the tool firmly.
4. Keep hands away from rotating parts.
5. Do not leave the tool running. Operate the tool only when hand-held.
6. Do not touch the drill bit or the workpiece immediately after operation; they may be extremely hot and could burn your skin.
7. Some material contains chemicals which may be toxic. Take caution to prevent dust inhalation and skin contact. Follow material supplier safety data.

SAVE THESE INSTRUCTIONS

⚠ WARNING:
MISUSE or failure to follow the safety rules stated in this instruction manual may cause serious personal injury.

SYMBOLS

USD201-2

The followings show the symbols used for tool.

V volts

A amperes

Hz hertz

 alternating current

n. no load speed

 Class II Construction

.../min. revolutions or reciprocation per minute

FUNCTIONAL DESCRIPTION

⚠ CAUTION:

- Always be sure that the tool is switched off and unplugged before adjusting or checking function on the tool.

Switch action

⚠ CAUTION:

- Before plugging in the tool, always check to see that the switch trigger actuates properly and returns to the “OFF” position when released.
- Switch can be locked in “ON” position for ease of operator comfort during extended use. Apply caution when locking tool in “ON” position and maintain firm grasp on tool.

To start the tool, simply pull the switch trigger. Tool speed is increased by increasing pressure on the switch trigger. Release the switch trigger to stop.

For continuous operation, pull the switch trigger and then push in the lock button.

To stop the tool from the locked position, pull the switch trigger fully, then release it.

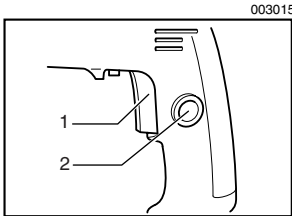

1. Switch trigger
2. Lock button

Reversing switch action

This tool has a reversing switch to change the direction of rotation. Move the reversing switch lever to the ← position (A side) for clockwise rotation or the → position (B side) for counterclockwise rotation.

⚠ CAUTION:

- Always check the direction of rotation before operation.
- Use the reversing switch only after the tool comes to a complete stop. Changing the direction of rotation before the tool stops may damage the tool.

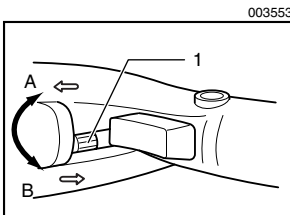

1. Reversing switch lever

ASSEMBLY

⚠ CAUTION:

- Always be sure that the tool is switched off and unplugged before carrying out any work on the tool.

003049

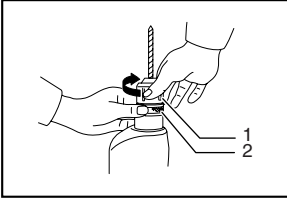

1. Sleeve
2. Ring

Installing or removing drill bit

Hold the ring and turn the sleeve counterclockwise to open the chuck jaws. Place the bit in the chuck as far as it will go. Hold the ring firmly and turn the sleeve clockwise to tighten the chuck.

To remove the bit, hold the ring and turn the sleeve counterclockwise.

OPERATION

Drilling operation

Drilling in wood

When drilling in wood, the best results are obtained with wood drills equipped with a guide screw. The guide screw makes drilling easier by pulling the bit into the workpiece.

Drilling in metal

To prevent the bit from slipping when starting a hole, make an indentation with a center-punch and hammer at the point to be drilled. Place the point of the bit in the indentation and start drilling.

Use a cutting lubricant when drilling metals. The exceptions are iron and brass which should be drilled dry.

⚠ CAUTION:

- Pressing excessively on the tool will not speed up the drilling. In fact, this excessive pressure will only serve to damage the tip of your bit, decrease the tool performance and shorten the service life of the tool.
- There is a tremendous twisting force exerted on the tool/bit at the time of hole breakthrough. Hold the tool firmly and exert care when the bit begins to break through the workpiece.
- A stuck bit can be removed simply by setting the reversing switch to reverse rotation in order to back out. However, the tool may back out abruptly if you do not hold it firmly.
- Always secure small workpieces in a vise or similar hold-down device.
- Avoid drilling in material that you suspect contains hidden nails or other things that may cause the bit to bind or break.

MAINTENANCE

⚠ CAUTION:

- Always be sure that the tool is switched off and unplugged before attempting to perform inspection or maintenance.

To maintain product SAFETY and RELIABILITY, repairs, carbon brush inspection and replacement, any other maintenance or adjustment should be performed by Makita Authorized or Factory Service Centers, always using Makita replacement parts.

ACCESSORIES

⚠ CAUTION:

- These accessories or attachments are recommended for use with your Makita tool specified in this manual. The use of any other accessories or attachments might present a risk of injury to persons. Only use accessory or attachment for its stated purpose.

If you need any assistance for more details regarding these accessories, ask your local Makita service center.

- Drill bits
- Keyless drill chuck

Cut



First-Class
Postage
Required

Post Office will
not deliver
without proper
postage.

Makita U.S.A., Inc.
14930 Northam Street
La Mirada, CA 90638-5753



Fold

MAIL THIS PORTION

Your answers to the following questions are appreciated.

1. This product was purchased from:

- Home Center
- Hardware/Lumber Store
- Tool Distributor
- Industrial Supply
- Construction Supply
- Other ()

3. How did you learn about this product:

- Magazine
- From Dealer
- Newspaper
- Store Display
- Catalog
- Radio
- Exhibition
- From Friend
- Previous Usage
- Other ()

2. Use of the product is intended for:

- Construction Trade
- Industrial Maintenance
- Home Maintenance
- Hobby
- Other ()

4. Most favored points are:

- Design
- Features
- Size
- Price
- Makita Brand
- Repair Service
- Durability
- Power
- Other ()

5. Any comments:

DATE PURCHASED			MODEL NO.															
MONTH		DAY		YEAR		SERIAL NO.												
INTL.	LAST NAME / COMPANY NAME											STATUS		SEX				
															Married	Single	M	F
STREET ADDRESS																		
CITY																		
STATE		ZIP CODE				PHONE				AREA CODE								
AGE:		<input type="checkbox"/> Under 19		<input type="checkbox"/> 20-29		<input type="checkbox"/> 30-39		<input type="checkbox"/> 40-49		<input type="checkbox"/> 50-60		<input type="checkbox"/> Over 60						

BE SURE TO COMPLETE THE CUSTOMER'S PORTION OF THIS FORM AND RETAIN FOR YOUR RECORDS.

Please return this portion by facsimile or mail.

Facsimile No: (714) 522-8133

FACTORY SERVICE CENTERS

1-800-4-MAKITA

RETAIN THIS PORTION FOR YOUR RECORDS

ARIZONA

3707 E. Broadway Rd., Ste. 6
Phoenix, AZ 85040
(602) 437-2850

CALIFORNIA

41850 Christy St.
Fremont, CA 94538-5107
(510) 657-9881

14930 Northam St.
La Mirada, CA 90638-5753
(714) 522-8088

1970 Fulton Avenue
Sacramento, CA 95825
(916) 482-5197

7674 Clairemont Mesa Blvd.
San Diego, CA 92111
(858) 278-4471

16735 Saticoy St., Ste. 105
Van Nuys, CA 91406
(818) 782-2440

COLORADO

11839 E. 51st Ave.
Denver, CO 80239-2709
(303) 371-2850

FLORIDA

750 East Sample Road
Pompano Beach, FL 33064
(954) 781-6333

GEORGIA

4680 River Green Parkway NW
Duluth, GA 30096
(770) 476-8911

ILLINOIS

1450 Feehanville Dr.
Mt. Prospect, IL 60056-6011
(847) 297-3100

MARYLAND

7397 Washington Boulevard,
Suite 104 Elkridge, MD 21075
(410) 476-4401

MASSACHUSETTS

232 Providence Hwy.
Westwood, MA 02090
(781) 461-9754

MINNESOTA

6427 Penn Ave. South
Richfield, MN 55423
(612) 869-5199

MISSOURI

9876 Watson Road
St. Louis, MO 63126-2221
(314) 909-9889

NEBRASKA

4129 S. 84th St.
Omaha, NE 68127
(402) 597-2925

NEVADA

3375 S. Decatur Blvd.
Suites. 22 - 24
Las Vegas, NV 89102
(702) 368-4277

NEW JERSEY

251 Herrod Blvd.
Dayton, NJ 08810-1539
(609) 655-1212

NEW YORK

4917 Genessee Street
Cheektowaga, NY 14225
(716) 685-9503

OREGON

828 19th Avenue, N.W.
Portland, OR 97209
(503) 222-1823

PENNSYLVANIA

1704 Babcock Blvd.
Pittsburgh, PA 15209
(412) 822-7370

PUERTO RICO

200 Guayama St.
Hato Rey, PR 00917
(787) 250-8776

TENNESSEE

1120 Elm Hill P.
Suite 170 Nashville, TN 372
(615) 248-3321

TEXAS

12801 Stemmons Fwy Ste. 809
Farmers Branch, TX 75234
(972) 243-1150

12701 Directors Dr.
Stafford, TX 77477-3701
(281) 565-8665

3453 IH-35 North, Ste. 101
San Antonio, TX 78219
(210) 228-0676

WISCONSIN

Lincoln Plaza Shopping Ctr.
2245 S. 108th St. West Allis, WI
53227
(414) 541-4776

CUSTOMER'S RECORD

<p>When you need service: Send complete tool (prepaid) to one of the Makita Factory Service Centers listed, or to an Authorized Makita Service Center. Be sure to attach a letter to the outside of the carton detailing the problem with your tool.</p>	Date Purchased
	Dealer's Name & Address
	Model No.
	Serial No.

WARNING

Some dust created by power sanding, sawing, grinding, drilling, and other construction activities contains chemicals known to the State of California to cause cancer, birth defects or other reproductive harm. Some examples of these chemicals are:

- lead from lead-based paints,
- crystalline silica from bricks and cement and other masonry products, and
- arsenic and chromium from chemically-treated lumber.

Your risk from these exposures varies, depending on how often you do this type of work. To reduce your exposure to these chemicals: work in a well ventilated area, and work with approved safety equipment, such as those dust masks that are specially designed to filter out microscopic particles.

MAKITA LIMITED ONE YEAR WARRANTY

Warranty Policy

Every Makita tool is thoroughly inspected and tested before leaving the factory. It is warranted to be free of defects from workmanship and materials for the period of ONE YEAR from the date of original purchase. Should any trouble develop during this one year period, return the COMPLETE tool, freight prepaid, to one of Makita's Factory or Authorized Service Centers. If inspection shows the trouble is caused by defective workmanship or material, Makita will repair (or at our option, replace) without charge.

This Warranty does not apply where:

- repairs have been made or attempted by others:
- repairs are required because of normal wear and tear:
- the tool has been abused, misused or improperly maintained:
- alterations have been made to the tool.

IN NO EVENT SHALL MAKITA BE LIABLE FOR ANY INDIRECT, INCIDENTAL OR CONSEQUENTIAL DAMAGES FROM THE SALE OR USE OF THE PRODUCT. THIS DISCLAIMER APPLIES BOTH DURING AND AFTER THE TERM OF THIS WARRANTY.

MAKITA DISCLAIMS LIABILITY FOR ANY IMPLIED WARRANTIES, INCLUDING IMPLIED WARRANTIES OF "MERCHANTABILITY" AND "FITNESS FOR A SPECIFIC PURPOSE," AFTER THE ONE YEAR TERM OF THIS WARRANTY.

This Warranty gives you specific legal rights, and you may also have other rights which vary from state to state. Some states do not allow the exclusion or limitation of incidental or consequential damages, so the above limitation or exclusion may not apply to you. Some states do not allow limitation on how long an implied warranty lasts, so the above limitation may not apply to you.

Makita Corporation of America

2650 Buford Hwy., Buford, GA 30518

Free Manuals Download Website

<http://myh66.com>

<http://usermanuals.us>

<http://www.somanuals.com>

<http://www.4manuals.cc>

<http://www.manual-lib.com>

<http://www.404manual.com>

<http://www.luxmanual.com>

<http://aubethermostatmanual.com>

Golf course search by state

<http://golfingnear.com>

Email search by domain

<http://emailbydomain.com>

Auto manuals search

<http://auto.somanuals.com>

TV manuals search

<http://tv.somanuals.com>