

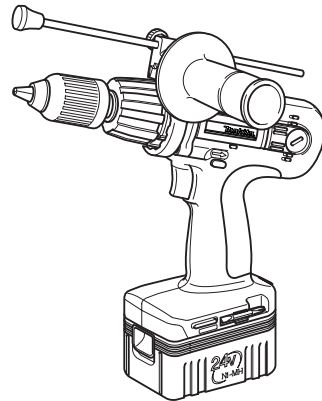

Cordless Driver Drill

Equipped with Electric Brake
MODEL BDF460



002040

I N S T R U C T I O N M A N U A L

⚠ WARNING:

For your personal safety, READ and UNDERSTAND before using.
SAVE THESE INSTRUCTIONS FOR FUTURE REFERENCE.

SPECIFICATIONS

Model		BDF460		
Capacities	Steel	13 mm (1/2")		
	Wood	38 mm (1 - 1/2")		
	Wood screw	10 x 90 mm (3/8" x 3-1/2")		
	Machine screw	6 mm (1/4")		
No load speed (RPM)	High	0 - 1,500/min.		
	Low	0 - 460/min.		
Overall length		259 mm (10-3/16")		
Net weight		2.6 kg (5.7 lbs)		
Battery Charger	DC24SA		DC24WA	
Input	A.C. only 50 Hz - 60 Hz			
Output	D.C. 7.2 V - 24 V			
Battery Cartridge	BH2420	BH2433	BH2420	BH2433
Voltage	24 V			
Charging time	30 min.	60 min.	55 min.	90 min.

- Manufacturer reserves the right to change specifications without notice.
- Specifications may differ from country to country.

GENERAL SAFETY RULES

USA003-1

(FOR ALL BATTERY OPERATED TOOLS)

⚠ WARNING:

Read and understand all instructions. Failure to follow all instructions listed below, may result in electric shock, fire and/or serious personal injury.

SAVE THESE INSTRUCTIONS

Work Area

1. **Keep your work area clean and well lit.** Cluttered benches and dark areas invite accidents.
2. **Do not operate power tools in explosive atmospheres, such as in the presence of flammable liquids, gases, or dust.** Power tools create sparks which may ignite the dust or fumes.
3. **Keep bystanders, children, and visitors away while operating a power tool.** Distractions can cause you to lose control.

Electrical Safety

4. **A battery operated tool with integral batteries or a separate battery pack must be recharged only with the specified charger for the battery.** A charger that may be suitable for one type of battery may create a risk of fire when used with another battery.
5. **Use battery operated tool only with specifically designated battery pack.** Use of any other batteries may create a risk of fire.

Personal Safety

6. **Stay alert, watch what you are doing, and use common sense when operating a power tool. Do not use tool while tired or under the influence of drugs, alcohol, or medication.** A moment of inattention while operating power tools may result in serious personal injury.
7. **Dress properly. Do not wear loose clothing or jewelry. Contain long hair. Keep your hair, clothing, and gloves away from moving parts.** Loose clothes, jewelry, or long hair can be caught in moving parts.
8. **Avoid accidental starting. Be sure switch is in the locked or off position before inserting battery pack.** Carrying tools with your finger on the switch or inserting the battery pack into a tool with the switch on invites accidents.

9. **Remove adjusting keys or wrenches before turning the tool on.** A wrench or a key that is left attached to a rotating part of the tool may result in personal injury.
10. **Do not overreach. Keep proper footing and balance at all times.** Proper footing and balance enable better control of the tool in unexpected situations.
11. **Use safety equipment. Always wear eye protection.** Dust mask, non-skid safety shoes, hard hat, or hearing protection must be used for appropriate conditions.

Tool Use and Care

12. **Use clamps or other practical way to secure and support the workpiece to a stable platform.** Holding the work by hand or against your body is unstable and may lead to loss of control.
13. **Do not force tool. Use the correct tool for your application.** The correct tool will do the job better and safer at the rate for which it is designed.
14. **Do not use tool if switch does not turn it on or off.** A tool that cannot be controlled with the switch is dangerous and must be repaired.
15. **Disconnect battery pack from tool or place the switch in the locked or off position before making any adjustments, changing accessories, or storing the tool.** Such preventive safety measures reduce the risk of starting the tool accidentally.
16. **Store idle tools out of reach of children and other untrained persons.** Tools are dangerous in the hands of untrained users.
17. **When battery pack is not in use, keep it away from other metal objects like: paper clips, coins, keys, nails, screws, or other small metal objects that can make a connection from one terminal to another.** Shorting the battery terminals together may cause sparks, burns, or a fire.

-
18. **Maintain tools with care. Keep cutting tools sharp and clean.** Properly maintained tools with sharp cutting edge are less likely to bind and are easier to control.
 19. **Check for misalignment or binding of moving parts, breakage of parts, and any other condition that may affect the tool's operation. If damaged, have the tool serviced before using.** Many accidents are caused by poorly maintained tools.
 20. **Use only accessories that are recommended by the manufacturer for your model.** Accessories that may be suitable for

one tool may create a risk of injury when used on another tool.

SERVICE

21. **Tool service must be performed only by qualified repair personnel.** Service or maintenance performed by unqualified personnel may result in a risk of injury.
22. **When servicing a tool, use only identical replacement parts. Follow instructions in the Maintenance section of this manual.** Use of unauthorized parts or failure to follow Maintenance instructions may create a risk of shock or injury.

SPECIFIC SAFETY RULES

USB022-2

DO NOT let comfort or familiarity with product (gained from repeated use) replace strict adherence to cordless drill safety rules. If you use this tool unsafely or incorrectly, you can suffer serious personal injury.

1. **Hold tool by insulated gripping surfaces when performing an operation where the cutting tool may contact hidden wiring.** Contact with a "live" wire will also make exposed metal parts of the tool "live" and shock the operator.
2. **Be aware that this tool is always in an operating condition, because it does not have to be plugged into an electrical outlet.**
3. **Always be sure you have a firm footing.**
4. **Be sure no one is below when using the tool in high locations.**
5. **Hold the tool firmly.**
6. **Keep hands away from rotating parts.**
7. **Do not leave the tool running. Operate the tool only when hand-held.**
8. **Do not touch the drill bit or the workpiece immediately after operation; they may be extremely hot and could burn your skin.**
9. **Some material contains chemicals which may be toxic. Take caution to prevent working dust inhalation and skin contact. Follow material supplier safety data.**

SAVE THESE INSTRUCTIONS

⚠ WARNING:
MISUSE or failure to follow the safety rules stated in this instruction manual may cause serious personal injury.

SYMBOLS

USD301-1

The followings show the symbols used for tool.

V volts

n_0 no load speed

$\overleftarrow{\text{---}}$ direct current

.../min.....revolutions or reciprocation per minute

IMPORTANT SAFETY INSTRUCTIONS FOR CHARGER & BATTERY CARTRIDGE

USC002-3

1. **SAVE THESE INSTRUCTIONS-** This manual contains important safety and operating instructions for battery charger.
2. Before using battery charger, read all instructions and cautionary markings on (1) battery charger, (2) battery, and (3) product using battery.
3. **CAUTION -** To reduce risk of injury, charge only **MAKITA** rechargeable batteries marked on the charger label. Other types of batteries may burst causing personal injury and damage.
4. Do not expose charger to rain or snow.
5. Use of an attachment not recommended or sold by the battery charger manufacturer may result in a risk of fire, electric shock, or injury to persons.
6. To reduce risk of damage to electric plug and cord, pull by plug rather than cord when disconnecting charger.
7. Make sure cord is located so that it will not be stepped on, tripped over, or otherwise subjected to damage or stress.
8. An extension cord should not be used unless absolutely necessary. Use of improper extension cord could result in a risk of fire and electric shock. If extension cord must be used, make sure:
 - a. That pins on plug of extension cord are the same number, size, and shape as those of plug on charger;
 - b. That extension cord is properly wired and in good electrical condition; and

- c. That wire size is at least as large as the one specified in the table below.

Table 1: RECOMMENDED MINIMUM AWG SIZE FOR EXTENSION CORDS FOR BATTERY CHARGERS

Length of Cord (Feet)	25	50	100	150
AWG Size of Cord	18	18	18	16

- 9. Do not operate charger with damaged cord or plug - replace them immediately.
- 10. Do not operate charger if it has received a sharp blow, been dropped, or otherwise damaged in any way; take it to a qualified serviceman.
- 11. Do not disassemble charger or battery cartridge; take it to a qualified serviceman when service or repair is required. Incorrect reassembly may result in a risk of electric shock or fire.
- 12. To reduce risk of electric shock, unplug charger from outlet before attempting any maintenance or cleaning. Turning off controls will not reduce this risk.
- 13. The battery charger is not intended for use by young children or infirm persons without supervision.
- 14. Young children should be supervised to ensure that they do not play with the battery charger.
- 15. If operating time has become excessively shorter, stop operating immediately. It may result in a risk of overheating, possible burns and even an explosion.
- 16. If electrolyte gets into your eyes, rinse them out with clear water and seek medical attention right away. It may result in loss of your eyesight.

ADDITIONAL SAFETY RULES FOR CHARGER & BATTERY CARTRIDGE

- 1. Do not charge Battery Cartridge when temperature is BELOW 10°C (50°F) or ABOVE 40°C (104°F).
 - 2. Do not attempt to use a step-up transformer, an engine generator or DC power receptacle.
 - 3. Do not allow anything to cover or clog the charger vents.
 - 4. Do not short the battery cartridge:
 - (1) Do not touch the terminals with any conductive material.
 - (2) Avoid storing battery cartridge in a container with other metal objects such as nails, coins, etc.
 - (3) Do not expose battery cartridge to water or rain.
 - 5. Do not store the tool and Battery Cartridge in locations where the temperature may reach or exceed 50°C (122°F).
 - 6. Do not incinerate the Battery Cartridge even if it is severely damaged or is completely worn out. The battery cartridge can explode in a fire.
 - 7. Be careful not to drop, shake or strike battery.
- A battery short can cause a large current flow, overheating, possible burns and even a breakdown.

-
8. Do not charge inside a box or container of any kind. The battery must be placed in a well ventilated area during charging.
-

SAVE THESE INSTRUCTIONS

SYMBOLS

The following show the symbols used for the charger. Be sure that you understand their meaning before use.

 Ready to charge

 Charging

 Charging complete

 Delay charge (Cooling)

 Defective battery

 Conditioning

 Cooling abnormality

FUNCTIONAL DESCRIPTION

⚠ CAUTION:

- Always be sure that the tool is switched off and the battery cartridge is removed before adjusting or checking function on the tool.

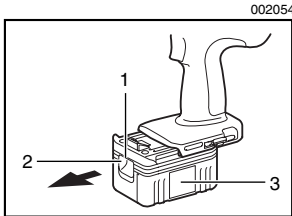

002054

1. Red part
2. Button
3. Battery cartridge

Installing or removing battery cartridge

- Always switch off the tool before insertion or removal of the battery cartridge.
- To remove the battery cartridge, withdraw it from the tool while sliding the button on the side of the cartridge.
- To insert the battery cartridge, align the tongue on the battery cartridge with the groove in the housing and slip it into place. Always insert it all the way until it locks in place with a little click. If you can see the red part on the upper side of the button, it is not locked completely. Insert it fully until the red part cannot be seen. If not, it may accidentally fall out of the tool, causing injury to you or someone around you.
- Do not use force when inserting the battery cartridge. If the cartridge does not slide in easily, it is not being inserted correctly.

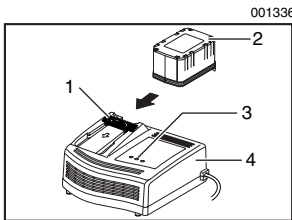

001336

1. Terminal cover
2. Battery cartridge
3. Charging light
4. Battery charger

Charging

1. Plug the battery charger into the proper AC voltage source. Two charging lights will flash in green color repeatedly.
2. Insert the battery cartridge into charger until it stops adjusting to the guide of charger. Terminal cover of charger can be opened with inserting and closed with pulling out the battery cartridge.
3. When the battery cartridge is inserted, the charging light color will change from green to red and charging will begin. The charging light will keep lighting up lit steadily during charging. One red charging light indicates charged condition in 0 - 80% and two red ones indicates 80 - 100%.
4. With finish of charge, the charging lights will change from two red ones to two green ones.

-
5. If you leave the battery cartridge in the charger after the charging cycle is complete, the charger will switch into its “trickle charge (maintenance charge)” mode which will last approximately 24 hours.
 6. After charging, unplug the charger from the power source.

NOTE:

- The battery charger is for charging Makita battery cartridge. Never use it for other purposes or for other manufacturer's batteries.
- When you charge a new battery cartridge or a battery cartridge which has not been used for a long period of time, it may not accept a full charge. This is a normal condition and does not indicate a problem. You can recharge the battery cartridge fully after discharging it completely and recharging a couple of times.
- If you charge a battery cartridge from a just operated tool or battery cartridge which has been left in a location exposed to direct sunlight for a long time, the charging light may flash in red color. If this occurs, wait for a while. Charging will begin after the battery cartridge is cooled by the cooling fan installed in the charger. (DC24SA only) When the temperature on battery is more than approx. 70°C, two charging lights may flash in red color, and when approx. 50°C - 70°C, one charging light in red color.
- If the charging light flashes alternately in green and red color, charging is not possible. The terminals on the charger or battery cartridge are clogged with dust or the battery cartridge is worn out or damaged.

Cooling system (DC24SA only)

- This charger is equipped with cooling fan for heated battery in order to enable the battery to prove its own performance. Sound of cooling air comes out during cooling, which means no trouble on the charger.
- Yellow light will flash for warning in the following cases.
 - Trouble on cooling fan
 - Incomplete cool down of battery, such as, being clogged with dustThe battery can be charged in spite of the yellow warning light. But the charging time will be longer than usual in this case.

-
- Check the sound of cooling fan, vent on the charger and battery, which can be sometime clogged with dust.
 - The cooling system is in order although no sound of cooling fan comes out, if the yellow warning light will not flash.
 - Always keep clean the vent on charger and battery for cooling.
 - The products should be sent to repair or maintenance, if the yellow warning light will frequently flash.

Conditioning charge (DC24SA only)

Conditioning charge can extend the life of battery by automatically searching the optimum charging condition for the batteries in every situations.

The battery employed in the following conditions repeatedly, will be worn out shortly, and yellow warning light may flash.

1. Recharge of battery with its high temperature
2. Recharge of battery with its low temperature
3. Recharge of full charged battery
4. Over-discharge of battery (continue to discharge battery in spite of down of power.)

The charging time of such battery is longer than usual.

Trickle charge (Maintenance charge)

If you leave the battery cartridge in the charger to prevent spontaneous discharging after full charge, the charger will switch into its “trickle charge (maintenance charge)” mode and keep the battery cartridge fresh and fully charged.

Tips for maintaining maximum battery life

1. Charge the battery cartridge before completely discharged.
Always stop tool operation and charge the battery cartridge when you notice less tool power.
2. Never recharge a fully charged battery cartridge.
Overcharging shortens the battery service life.
3. Charge the battery cartridge with room temperature at 10°C - 40°C (50°F - 104°F).
Let a hot battery cartridge cool down before charging it.
4. Charge the Nickel Metal Hydride battery cartridge when you do not use it for more than six months.

002080

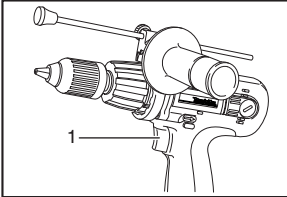

1. Switch trigger

Switch action

⚠ CAUTION:

- Before inserting the battery cartridge into the tool, always check to see that the switch trigger actuates properly and returns to the “OFF” position when released.

To start the tool, simply pull the switch trigger. Tool speed is increased by increasing pressure on the switch trigger. Release the switch trigger to stop.

Electric brake

This tool is equipped with an electric brake. If the tool consistently fails to quickly stop after switch trigger release, have tool serviced at a Makita service center.

002090

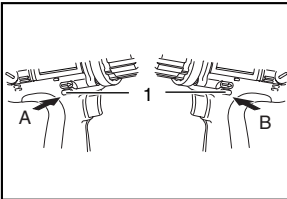

1. Reversing switch lever

Reversing switch action

This tool has a reversing switch to change the direction of rotation. Depress the reversing switch lever from the A side for clockwise rotation or from the B side for counterclockwise rotation.

When the reversing switch lever is in the neutral position, the switch trigger cannot be pulled.

⚠ CAUTION:

- Always check the direction of rotation before operation.
- Use the reversing switch only after the tool comes to a complete stop. Changing the direction of rotation before the tool stops may damage the tool.
- When not operating the tool, always set the reversing switch lever to the neutral position.

002097

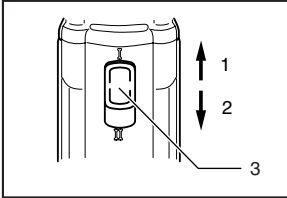

1. Low speed
2. High speed
3. Speed change lever

Speed change

To change the speed, first switch off the tool and then slide the speed change lever to the “I” side for high speed or “II” side for low speed. Be sure that the speed change lever is set to the correct position before operation. Use the right speed for your job.

⚠ CAUTION:

- Always set the speed change lever fully to the correct position. If you operate the tool with the speed change lever positioned halfway between the “I” side and “II” side, the tool may be damaged.
- Do not use the speed change lever while the tool is running. The tool may be damaged.

002105

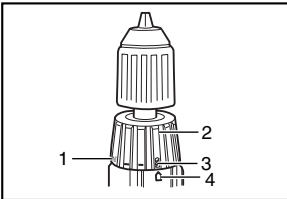

1. Graduations
2. Adjusting ring
3. Drill marking
4. Pointer

Adjusting the fastening torque

The fastening torque can be adjusted in 17 steps by turning the adjusting ring so that its graduations are aligned with the pointer on the tool body. The fastening torque is minimum when the number 1 is aligned with the pointer, and maximum when the  marking is aligned with the pointer.

The clutch will slip at various torque levels when set at the number 1 to 16. The clutch is designed not to slip at the  marking.

Before actual operation, drive a trial screw into your material or a piece of duplicate material to determine which torque level is required for a particular application.

NOTE:

- The adjusting ring does not lock when the pointer is positioned only halfway between the graduations.
- Do not operate the tool with the adjusting ring set between the number 16 and the  marking. The tool may be damaged.

ASSEMBLY

⚠ CAUTION:

- Always be sure that the tool is switched off and the battery cartridge is removed before carrying out any work on the tool.

Installing side grip (auxiliary handle)

⚠ CAUTION:

- Always be sure that the side grip is installed securely before operation.

Always use the side grip to ensure operating safety. Install the side grip so that the teeth on the grip fit in between the protrusions on the tool barrel.

Then tighten the grip by turning clockwise at the desired position. It may be swung 360° so as to be secured at any position.

002109

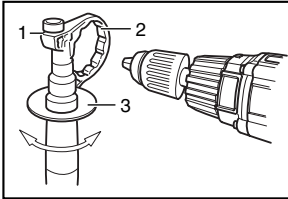

1. Grip base
2. Teeth
3. Side grip

002121

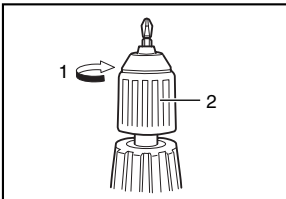

1. Tighten
2. Sleeve

Installing or removing driver bit or drill bit

Turn the sleeve counterclockwise to open the chuck jaws. Place the bit in the chuck as far as it will go. Turn the sleeve clockwise to tighten the chuck.

To remove the bit, turn the sleeve counterclockwise.

002122

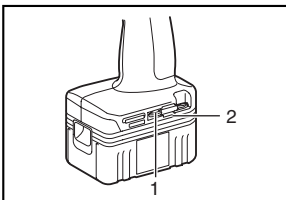

1. Bit
2. Bit holder

When not using the driver bit, keep it in the bit holders. Bits 45 mm (1-3/4") long can be kept there.

002127

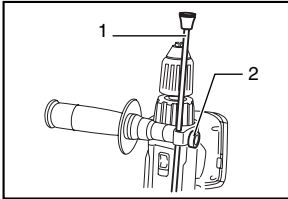

1. Depth rod
2. Clamp screw

Adjustable depth rod

The adjustable depth rod is used to drill holes of uniform depth. Loosen the clamp screw, set to desired position, then tighten the clamp screw.

OPERATION

⚠ CAUTION:

- Always insert the battery cartridge all the way until it locks in place. If you can see the red part on the upper side of the button, it is not locked completely. Insert it fully until the red part cannot be seen. If not, it may accidentally fall out of the tool, causing injury to you or someone around you.
- When operating overhead, always make sure the battery cartridge is locked securely so that it will not be fallen out of the tool. If not, it may accidentally fall out of the tool, causing injury to you or someone around you.

002135

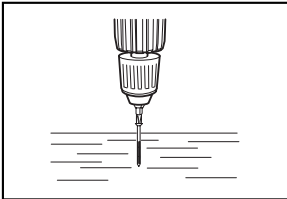

Screwdriving operation

Place the point of the driver bit in the screw head and apply pressure to the tool. Start the tool slowly and then increase the speed gradually. Release the switch trigger as soon as the clutch cuts in.

NOTE:

- Make sure that the driver bit is inserted straight in the screw head, or the screw and/or bit may be damaged.
- When driving wood screws, predrill pilot holes to make driving easier and to prevent splitting of the workpiece. See the chart.

Nominal diameter of wood screw (mm)	Recommended size of pilot hole (mm)
3.1 (1/8")	2.0 - 2.2 (5/64" - 3/32")
3.5 (9/64")	2.2 - 2.5 (3/32" - 3/32")
3.8 (5/32")	2.5 - 2.8 (3/32" - 7/64")
4.5 (11/64")	2.9 - 3.2 (7/64" - 1/8")
4.8 (3/16")	3.1 - 3.4 (1/8" - 9/64")
5.1 (13/64")	3.3 - 3.6 (1/8" - 9/64")
5.5 (7/32")	3.7 - 3.9 (9/64" - 5/32")
5.8 (7/32")	4.0 - 4.2 (5/32" - 11/64")
6.1 (15/64")	4.2 - 4.4 (11/64" - 11/64")

- If the tool is operated continuously until the battery cartridge has discharged, allow the tool to rest for 15 minutes before proceeding with a fresh battery.

Drilling operation

First, turn the adjusting ring so that the pointer points to the  marking. Then proceed as follows.

Drilling in wood

When drilling in wood, the best results are obtained with wood drills equipped with a guide screw. The guide screw makes drilling easier by pulling the bit into the workpiece.

Drilling in metal

To prevent the bit from slipping when starting a hole, make an indentation with a center-punch and hammer at the point to be drilled. Place the point of the bit in the indentation and start drilling.

Use a cutting lubricant when drilling metals. The exceptions are iron and brass which should be drilled dry.

CAUTION:

- Pressing excessively on the tool will not speed up the drilling. In fact, this excessive pressure will only serve to damage the tip of your bit, decrease the tool performance and shorten the service life of the tool.
- There is a tremendous force exerted on the tool/bit at the time of hole break through. Hold the tool firmly and exert care when the bit begins to break through the workpiece.
- A stuck bit can be removed simply by setting the reversing switch to reverse rotation in order to back out. However, the tool may back out abruptly if you do not hold it firmly.

- Always secure small workpieces in a vise or similar hold-down device.
- If the tool is operated continuously until the battery cartridge has discharged, allow the tool to rest for 15 minutes before proceeding with a fresh battery.

MAINTENANCE

⚠ CAUTION:

- Always be sure that the tool is switched off and the battery cartridge is removed before attempting to perform inspection or maintenance.

Replacing carbon brushes

Remove and check the carbon brushes regularly. Replace when they wear down to the limit mark. Keep the carbon brushes clean and free to slip in the holders. Both carbon brushes should be replaced at the same time. Use only identical carbon brushes.

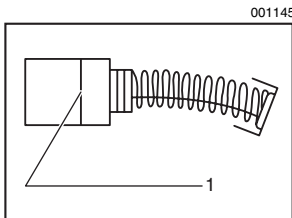

1. Limit mark

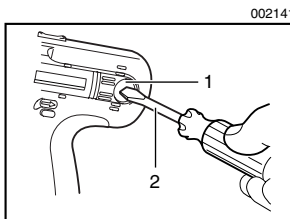

1. Brush holder cap
2. Screwdriver

Use a screwdriver to remove the brush holder caps. Take out the worn carbon brushes, insert the new ones and secure the brush holder caps.

After replacing brushes, insert the battery cartridge into the tool and break in brushes by running tool with no load for about 1 minute. Then check the tool while running and electric brake operation when releasing the switch trigger. If electric brake is not working well, ask your local Makita service center for repair.

To maintain product SAFETY and RELIABILITY, repairs, any other maintenance or adjustment should be performed by Makita Authorized or Factory Service Centers, always using Makita replacement parts.

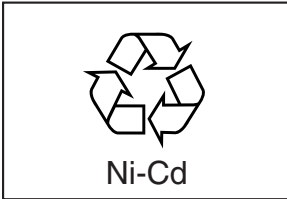

Recycling the Battery

The only way to dispose of a Makita battery is to recycle it. The law prohibits any other method of disposal.

To recycle the battery:

1. Remove the battery from the tool.
2. a) Take the battery to your nearest Makita Factory Service Center
or
b) Take the battery to your nearest Makita Authorized Service Center or Distributor that has been designated as a Makita battery recycling location.

Call your nearest Makita Service Center or Distributor to determine the location that provides Makita battery recycling. See your local Yellow Pages under "Tools-Electric".

ACCESSORIES

⚠ CAUTION:

- These accessories or attachments are recommended for use with your Makita tool specified in this manual. The use of any other accessories or attachments might present a risk of injury to persons. Only use accessory or attachment for its stated purpose.

If you need any assistance for more details regarding these accessories, ask your local Makita service center.

- Drill bits
- Screw bits
- Grip assembly
- Depth rod
- Plastic carrying case

Cut



**Makita Canada Inc.
1950 Forbes Street,
Whitby, Ontario
L1N 7B7**

Fold

Factory Service Centres

Head Office:	1950 Forbes St., Whitby, Ontario, L1N 7B7 (905) 571 - 2200	1-800-263-3734
Regional Office:	11771 Hammersmith Way, Richmond B.C. V7A 5H6 (604) 272 - 3104	1-800-663-0909
Regional Office: (Montreal)	6389 boul. Couture, St. Leonard, Quebec H1P 3J5 (514) 323 - 1223	1-800-361-7049
Dartmouth:	202 Brownlow Avenue Dartmouth, N.S., B3B 1T5 (902) 468 - 7064	1-888-625-4821
Ville St. Laurent: (Montreal)	1140 Rue Bégin, Ville St. Laurent, Quebec H4R 1X1 (514) 745 - 5025	1-888-745-5025
Les Saules: (Quebec)	1200 St. Jean Baptiste, Unit 106, Les Saules, Quebec, G2E 5E8 (418) 871 - 5720	1-800-663-5757
Nepean: (Ottawa)	203 Colonnade Road, Unit #6, Nepean, Ontario K2E 7K3 (613) 224 - 5022	1-888-560-2214
Whitby:	1950 Forbes St., Whitby, Ontario, L1N 7B7 (905) 571 - 2200	1-800-263-3734
London:	317 Adelaide St. S., Unit 117, London, Ontario, N5Z 3L3 (519) 686 - 3115	1-800-571-0899
Mississauga:	6350 Tomken Rd., Unit 8, Mississauga, Ontario, L5T 1Y3 (905) 670 - 7255	1-888-221-9811
Calgary:	#8-6115 Fourth St. S.E., Calgary Alberta, T2H 2H9 (403) 243 - 3995	1-800-267-0445
Edmonton:	11614-149 Street, Edmonton, Alberta, T5M 3R3 (780) 455 - 6644	1-888-455-6644
Richmond:	11771 Hammersmith Way, Richmond, B.C., V7A 5H6 (604) 272 - 3104	1-800-663-0909
Coquitlam:	2131 Hartley Ave., #103 Coquitlam, B.C. V3K 2Z3 (604) 525 - 7434	1-800-266-7738
Winnipeg:	1670 St. James Street, Winnipeg, Manitoba, R3H 0L3 (204) 694 - 0402	1-800-550-5073
Saskatoon:	206A-2750 Faithful Avenue Saskatoon, Saskatchewan, S7K 6M6 (306) 931 - 0111	1-888-931-0111

For the authorized service centre nearest you please refer to the local yellow pages directory under "tools" or contact our customer service department (Tel) 1-800-263-3734

When you need service...

- Explain the problem in a letter
- Enclose the letter with the tool
- Package carefully and send prepaid to the nearest Makita factory or authorized service centre

CUSTOMER RECORD

DATE
PURCHASED: _____

DEALER'S NAME
& ADDRESS: _____

MODEL NO.: _____

SERIAL NO.: _____

MAKITA LIMITED ONE YEAR WARRANTY

Warranty Policy

Every Makita tool is thoroughly inspected and tested before leaving the factory. It is warranted to be free of defects from workmanship and materials for the period of ONE YEAR from the date of original purchase. Should any trouble develop during this one year period, return the COMPLETE tool, freight prepaid, to one of Makita's Factory or Authorized Service Centres. If inspection shows the trouble is caused by defective workmanship or material, Makita will repair (or at our option, replace) without charge.

This Warranty does not apply:

- where normal maintenance is required,
- repairs have been made or attempted by others,
- the tool has been abused, misused or improperly maintained,
- alterations have been made to the tool.

IN NO EVENT SHALL MAKITA BE LIABLE FOR ANY INDIRECT, INCIDENTAL OR CONSEQUENTIAL DAMAGES FROM THE SALE OR USE OF THE PRODUCT. THIS DISCLAIMER APPLIES BOTH DURING AND AFTER THE TERM OF THIS WARRANTY.

"The Makita Warranty is the only and the entire written warranty given by Makita for the Makita tools. No dealer or his agent or employee is authorized to extend or enlarge upon this warranty by any verbal or written statement or advertisement."

MAKITA DISCLAIMS LIABILITY FOR ANY IMPLIED WARRANTIES INCLUDING IMPLIED WARRANTIES OF "MERCHANTABILITY" AND FITNESS FOR A SPECIFIC PURPOSE," AFTER THE ONE YEAR TERM OF THIS WARRANTY.

"This Warranty gives you specific rights. The provisions contained in this warranty are not intended to limit, modify, take away from, disclaim or exclude any warranties set forth in any provincial legislation. To the extent required by law, the provisions in any provincial or federal legislation with respect to warranties take precedence over the provisions in this warranty."

Makita Corporation
3-11-8, Sumiyoshi-cho,
Anjo, Aichi 446-8502 Japan

Free Manuals Download Website

<http://myh66.com>

<http://usermanuals.us>

<http://www.somanuals.com>

<http://www.4manuals.cc>

<http://www.manual-lib.com>

<http://www.404manual.com>

<http://www.luxmanual.com>

<http://aubethermostatmanual.com>

Golf course search by state

<http://golfingnear.com>

Email search by domain

<http://emailbydomain.com>

Auto manuals search

<http://auto.somanuals.com>

TV manuals search

<http://tv.somanuals.com>