

**IMPORTANT** — To assure product **SAFETY** and **RELIABILITY**, repairs, maintenance or adjustments should be performed by **MAKITA** Service Centers or other qualified service organizations. Always use **MAKITA** replacement parts.

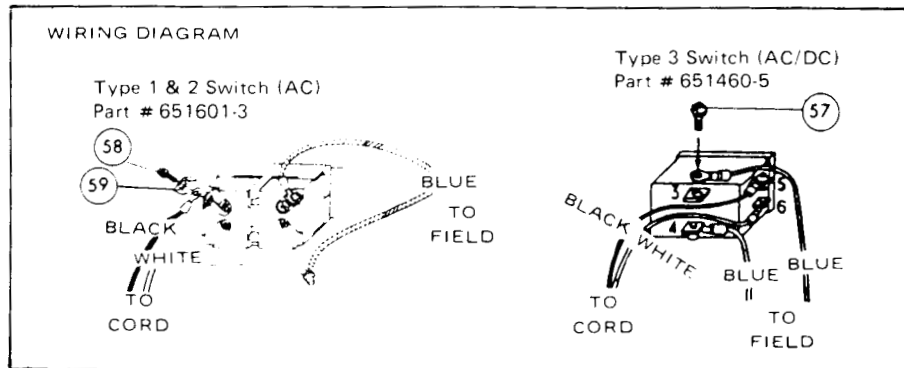

Fig.	Part No.	Qty. Used	Description	Fig.	Part No.	Qty. Used	Description
1	911136-9	4	SCREW M4X20	35	221229-7	1	SPIRAL BEVEL GEAR 15
2	156050-4	1	GEAR HOUSING (WITH PLANE BEARING 6, 214006-4)	36	254002-0	1	WOODRUFF KEY 3
3	211088-7	1	BALL BEARING 6000DDW	37	961006-2	1	RETAINING RING S-10
4	911216-1	2	SCREW M5X14	38	221232-8	1	SPIRAL BEVEL GEAR 35
5	285604-1	1	BEARING RETAINER 35	39	911121-2	3	SCREW M4X14
6	241068-9	1	FAN	40	285616-4	1	BEARING RETAINER 40
7	*****	1	ARMATURE ASSEMBLY (ASSEMBLED FIG.'S 6,7,14 & 16)	41	211129-9	1	BALL BEARING 6201DDW
8	911200-6	2	SCREW M4X70	42	253055-6	1	WASHER
9	*****	1	FIELD ASSEMBLY (WITH FIG. 55)	44	254002-0	1	WOODRUFF KEY 3
10	***	1	MOTOR HOUSING (WITH 2 EA. BRUSH HOLDER, 643557-4)	45	****	1	SPINDLE
11	*	1	STOP RING E-2.3 (TYPE 2 & 3)	47	312629-3	1	BEARING BOX
12	*	1	SWITCH ROD	48	911121-2	4	P.H. SCREW M4X14
13	*	1	SWITCH HOLDER	50	911221-8	3	SCREW M5X16
14	681614-0	1	INSULATION WASHER	53	164329-9	1	GRIP HOLDER
15	263002-9	1	RUBBER PIN 4	54	231223-1	1	COMPRESSION SPRING 6
16	211026-9	1	BALL BEARING 627LLB	55	654018-9	2	GARTER SPRING
17	*	1	SWITCH LEVER	56	*	1	SCREW M2.6X8 (TYPE 1)
18	*****	2	CARBON BRUSH	57	652021-4	4	TERMINAL SCREW
19	643550-8	2	BRUSH CAP	58	652007-8	2	TERMINAL SCREW
21	687001-1	1	STRAIN RELIEF	59	652250-9	2	CLAMP WASHER
22	911123-8	2	SCREW M4X14	60	273485-5	1	AUXILIARY HANDLE
23	911006-2	1	SCREW M3X8 (TYPE 1 & 2)	<b>ACCESSORIES</b>			
24	911106-8	2	SCREW M4X8	400	782401-1		LOCK NUT WRENCH 20
25	687637-6	1	SET PLATE	401	741402-8		4" DEPRESSED CENTER WHEEL, #24
26	*	1	SWITCH	402	781007-2		WRENCH
27	911133-5	2	SCREW M4X18	403	191686-2		SAFETY GOGGLES
28	682502-4	1	CORD GUARD	406	342554-4		WHEEL COVER
30	953106-2	4	RIVET	407	****		INNER FLANGE
31	411218-2	1	REAR COVER	408	****		LOCK NUT
32	664013-1	1	CORD WITH PLUG (2X18X8;SJ)	409	181717-5		STEEL TOOL CASE
33	911188-0	2	SCREW M4X60				

**SERVICE CHANGE**

1) Change on Switch and Switch Lever.

- \*SEE SERVICE CHANGE 1
- \*\*SEE SERVICE CHANGE 2
- \*\*\*SEE SERVICE CHANGE 3
- \*\*\*\*SEE SERVICE CHANGE 4
- \*\*\*\*\*SEE SERVICE CHANGE 5
- \*\*\*\*\*SEE SERVICE CHANGE 6

**TYPE 1**

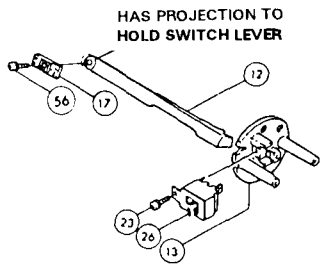

**TYPE 2**

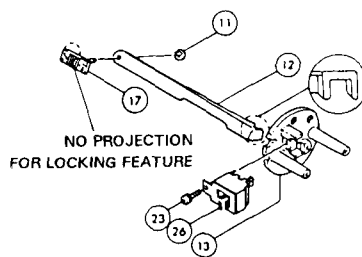

**TYPE 3**

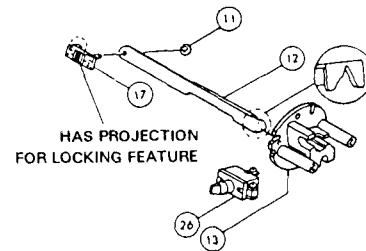

Fig.	Description	Type 1	Type 2	Type 3
11	Stop Ring	-----	Part #257903-1	
12	Switch Rod	Part #411178-8 (Discontinued)	Part #411328-5	Part #411491-4 (See Service Change 2)
13	Switch Holder	Part #411179-6		Part #411490-6
17	Switch Lever	Part #682044-6 (Discontinued)	Part #411508-3	Part #411492-2 (See Service Change 2)
23	Screw M3x8	Part #911006-2		
26	Switch	Part #651601-3		Part #651460-5
56	Screw M2.6x8	Part #912854-1 (Discontinued)	-----	

The above parts are completely interchangeable as a set.

5) Change on Motor from Serial Number 1,706,374E.

TYPE 1

TYPE 2

ARMATURE

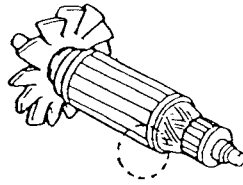

WHITE WEDGES  
Part #611252-4

GREEN WEDGES  
Part #618819-9

FIELD

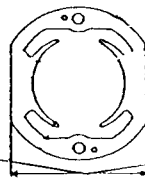

1-11/16" (43mm)  
Part #621092-2

1-7/8" (48mm)  
Part #633131-6

CARBON BRUSH



13/64" (5mm) THICK  
BY 5/16" (8mm)  
CB-72  
Part #643072-8

15/64" (6mm) THICK  
BY 23/64" (9mm)  
CB-408  
Part #643408-1

GARTER SPRING

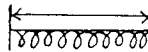

1" (25.8mm)  
Part #654018-9

1-3/16" (30mm)  
Part #654100-4

Fig.	Description	Type 1	Type 2
7	Armature	Part #611252-4	Part #618819-9
9	Field	Part #621092-2 (w/Garter Spring 654018-9)	Part #633131-6 (w/Garter Spring 654100-4)
10	Motor Housing	Part #159175-3 (w/Brush Holder 643557-4)	Part #159283-0 (w/Brush Holder 643917-0)
18	Carbon Brush	Part #643072-8	Part #643408-1

The above parts are completely interchangeable as a set.  
Type 2 Armature replaces Type 1 Armature individually.

NOTE

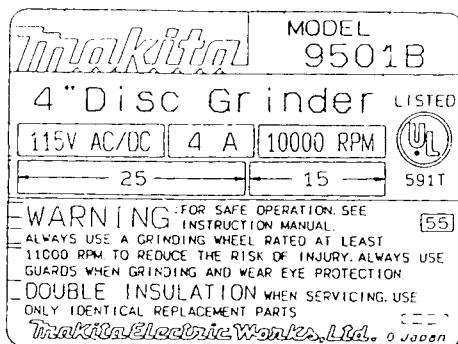

Type 2 tools have 55 marking on the name plate.

4) Change on Flange and Lock Nut from Serial Number 1,672,683E.

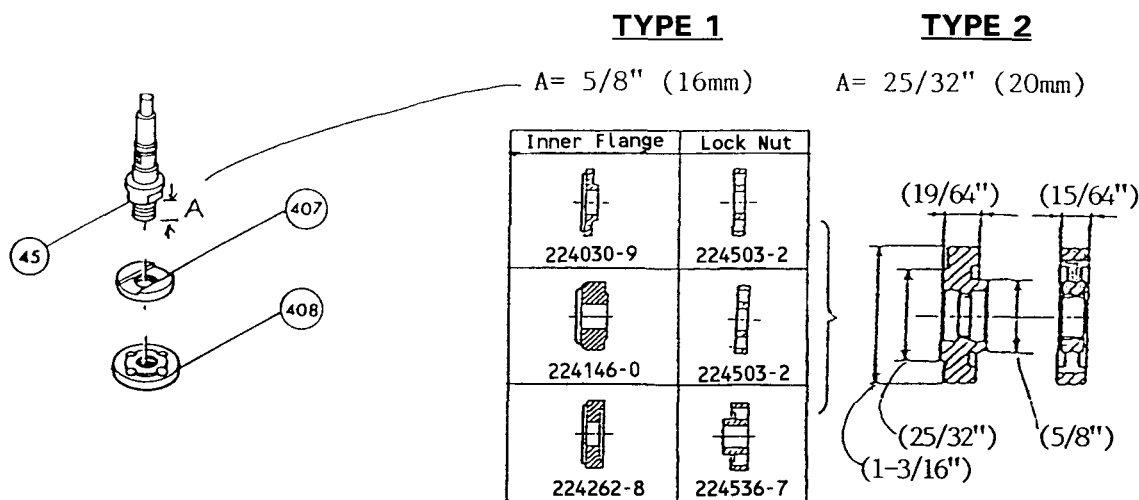

Fig.	Description	Type 1	Type 2
45	Spindle	Part #325329-6 (Discontinued)	Part #322423-5
407	Inner Flange (Depressed center wheel)	Part #224030-9	Part #224278-3  (See Service Change 6)
	Inner Flange (Diamond wheel)	Part #224146-0	
	Inner Flange (Abrasive cut-off wheel)	Part #224262-8	
408	Lock Nut (Depressed center wheel) (Diamond wheel)	Part #224503-2	Part #224541-4  (See Service Change 6)
	Lock Nut (Abrasive cut-off wheel)	Part #224536-7	

When using Diamond wheel, flip over the Inner Flange to face 25/32" (20mm) Diameter side to the Diamond wheel.

**INTERCHANGEABILITY OF CURRENT PARTS AND THE NEW PARTS.**

Model	Combination		Depressed center wheel	Abrasive cut-off wheel	Diamond wheel	Flex wheel	Multi-disc
	Spindle	Flange & Lock Nut					
9501B	(T1)	(T2)	no	yes	yes	no	no
	(T2)	(T1)	yes	yes*	yes**	yes	yes

- \* mark indicates Inner Flange (Part #224262-8) and Lock Nut (Part #224536-7) should be used; \*\* mark indicates Inner Flange (Part #224146-0) and Lock Nut (Part #224503-2) should be used.
- Never use the tool under the condition of "No". The accessory installed on the tool may come loose and fly out dangerously during operation.

2) Change on Switch Lever.

**TYPE 3**

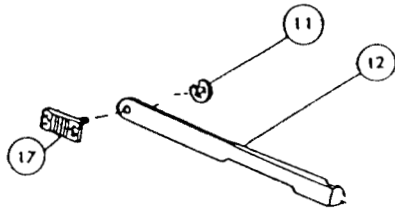

**TYPE 4**

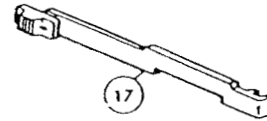

ONE-PIECE UNIT

Fig.	Description	Type 3	Type 4
11	Stop Ring	Part #257903-1	_____
12	Switch Rod	Part #411491-4	_____
17	Switch Lever	Part #411492-2	Part #414524-4 (See Service Change 3)

The above items are completely interchangeable as a set.

3) Change on Switch Lever and Motor Housing.

**TYPE 4**

**TYPE 5**

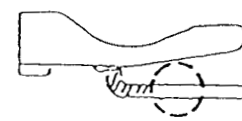
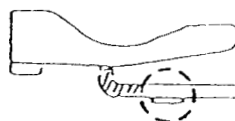
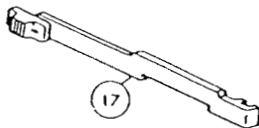
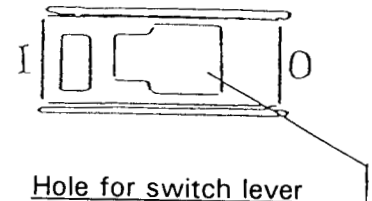
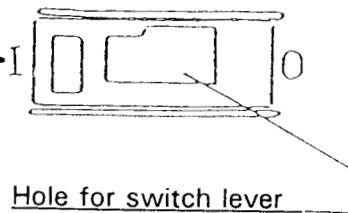
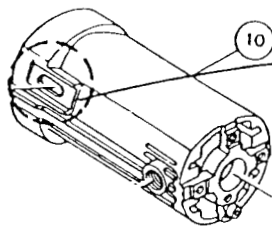
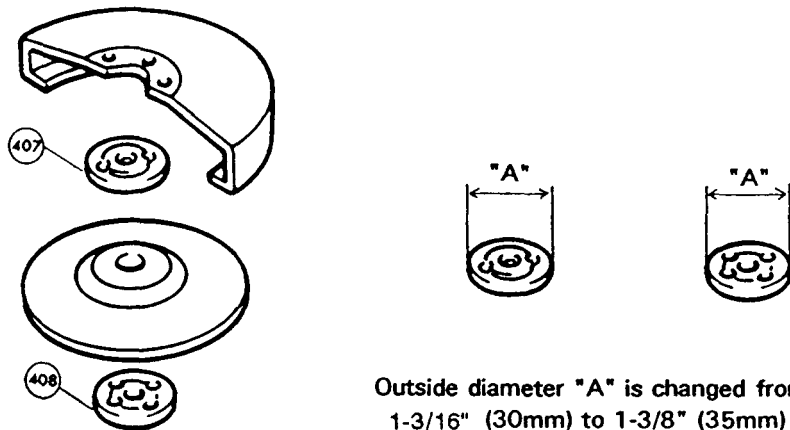

Fig.	Description	Type 4	Type 5
10	Motor Housing	Part #156096-0 (Discontinued)	Part #159175-3 (See Service Change 5)
17	Switch Lever	Part #414524-4 (Discontinued)	Part #414660-6

The above parts are completely interchangeable as a set.

6) Change on Inner Flange & Lock Nut from serial number 1,845,053E.



Outside diameter "A" is changed from:  
1-3/16" (30mm) to 1-3/8" (35mm)

FIG.	DESCRIPTION	TYPE 2	TYPE 3
407	Inner Flange	Part # 224278-3	Part # 224291-1
408	Lock Nut	Part # 224541-4	Part # 224545-6

The above parts are completely interchangeable as a set.

**NOTE:** Standard equipment will change to Type 3 Inner Flange and Lock Nut. They fit all accessories. (Grinding Wheel, cut-off, Diamond Wheel, Multi Disc.) Except Type 2 will remain used for Flex Wheel application, Sanding Disc uses Lock Nut 224501-6.

## Free Manuals Download Website

<http://myh66.com>

<http://usermanuals.us>

<http://www.somanuals.com>

<http://www.4manuals.cc>

<http://www.manual-lib.com>

<http://www.404manual.com>

<http://www.luxmanual.com>

<http://aubethermostatmanual.com>

Golf course search by state

<http://golfingnear.com>

Email search by domain

<http://emailbydomain.com>

Auto manuals search

<http://auto.somanuals.com>

TV manuals search

<http://tv.somanuals.com>