



# Cordless Impact Wrench

Equipped with Electric Brake

9.5 mm (3/8")

MODEL 6991D

12.7 mm (1/2")

MODEL 6992D

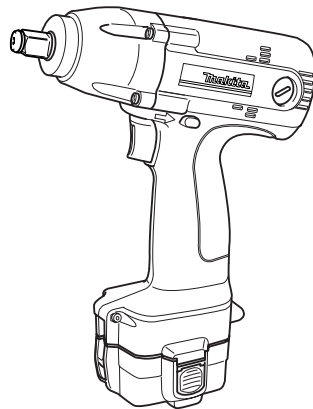

## I N S T R U C T I O N M A N U A L

**⚠ WARNING:**

For your personal safety, READ and UNDERSTAND before using.  
SAVE THESE INSTRUCTIONS FOR FUTURE REFERENCE.

[www.makitatools.com](http://www.makitatools.com)

# SPECIFICATIONS

Model		6991D	6992D
Capacities	Standard bolt	M8 - M14 (5/16" - 9/16")	M8 - M14 (5/16" - 9/16")
	High tensile bolt	M6 - M10 (1/4" - 3/8")	M6 - M10 (1/4" - 3/8")
Square drive		9.5 mm (3/8")	12.7 mm (1/2")
No load speed (RPM)		0 - 2,300/min.	0 - 2,300/min.
Impacts per minute		0 - 3,000	0 - 3,000
Max. fastening torque		100 N.m (73 ft.lbs)	100 N.m (73 ft.lbs)
Overall length		168 mm (6-5/8")	176 mm (6-29/32")
Net weight		1.3 kg (2.9 lbs)	1.4 kg (3.1 lbs)

Battery Cartridge	Voltage	Battery Charger	Input	Output	Charging time
9122	9.6 V	DC1413	A. C. only 50 Hz - 60 Hz	D. C. 7.2 V - 14.4 V	45 min.
9134					60 min.
9135					70 min.

- Manufacturer reserves the right to change specifications without notice.
- Specifications may differ from country to country.

# GENERAL SAFETY RULES

USA003-1

## (FOR ALL BATTERY OPERATED TOOLS)

### **⚠ WARNING:**

**Read and understand all instructions.** Failure to follow all instructions listed below, may result in electric shock, fire and/or serious personal injury.

# SAVE THESE INSTRUCTIONS

---

## Work Area

1. **Keep your work area clean and well lit.** Cluttered benches and dark areas invite accidents.
2. **Do not operate power tools in explosive atmospheres, such as in the presence of flammable liquids, gases, or dust.** Power tools create sparks which may ignite the dust or fumes.
3. **Keep bystanders, children, and visitors away while operating a power tool.** Distractions can cause you to lose control.

## Electrical Safety

4. **A battery operated tool with integral batteries or a separate battery pack must be recharged only with the specified charger for the battery.** A charger that may be suitable for one type of battery may create a risk of fire when used with another battery.
5. **Use battery operated tool only with specifically designated battery pack.** Use of any other batteries may create a risk of fire.

## Personal Safety

6. **Stay alert, watch what you are doing, and use common sense when operating a power tool. Do not use tool while tired or under the influence of drugs, alcohol, or medication.** A moment of inattention while operating power tools may result in serious personal injury.
7. **Dress properly. Do not wear loose clothing or jewelry. Contain long hair. Keep your hair, clothing, and gloves away from moving parts.** Loose clothes, jewelry, or long hair can be caught in moving parts.
8. **Avoid accidental starting. Be sure switch is in the locked or off position before inserting battery pack.** Carrying tools with your finger on the switch or inserting the battery pack into a tool with the switch on invites accidents.
9. **Remove adjusting keys or wrenches before turning the tool on.** A wrench or a

key that is left attached to a rotating part of the tool may result in personal injury.

10. **Do not overreach. Keep proper footing and balance at all times.** Proper footing and balance enable better control of the tool in unexpected situations.
11. **Use safety equipment. Always wear eye protection.** Dust mask, non-skid safety shoes, hard hat, or hearing protection must be used for appropriate conditions.

## Tool Use and Care

12. **Use clamps or other practical way to secure and support the workpiece to a stable platform.** Holding the work by hand or against your body is unstable and may lead to loss of control.
13. **Do not force tool. Use the correct tool for your application.** The correct tool will do the job better and safer at the rate for which it is designed.
14. **Do not use tool if switch does not turn it on or off.** A tool that cannot be controlled with the switch is dangerous and must be repaired.
15. **Disconnect battery pack from tool or place the switch in the locked or off position before making any adjustments, changing accessories, or storing the tool.** Such preventive safety measures reduce the risk of starting the tool accidentally.
16. **Store idle tools out of reach of children and other untrained persons.** Tools are dangerous in the hands of untrained users.
17. **When battery pack is not in use, keep it away from other metal objects like: paper clips, coins, keys, nails, screws, or other small metal objects that can make a connection from one terminal to another.** Shorting the battery terminals together may cause sparks, burns, or a fire.
18. **Maintain tools with care. Keep cutting tools sharp and clean.** Properly maintained tools with sharp cutting edge are less likely to bind and are easier to control.

- 
19. **Check for misalignment or binding of moving parts, breakage of parts, and any other condition that may affect the tool's operation. If damaged, have the tool serviced before using.** Many accidents are caused by poorly maintained tools.
  20. **Use only accessories that are recommended by the manufacturer for your model.** Accessories that may be suitable for one tool may create a risk of injury when used on another tool.

## SERVICE

21. **Tool service must be performed only by qualified repair personnel.** Service or maintenance performed by unqualified personnel may result in a risk of injury.
22. **When servicing a tool, use only identical replacement parts. Follow instructions in the Maintenance section of this manual.** Use of unauthorized parts or failure to follow Maintenance instructions may create a risk of shock or injury.

---

## SPECIFIC SAFETY RULES

USB025-2

**DO NOT let comfort or familiarity with product (gained from repeated use) replace strict adherence to cordless impact wrench safety rules. If you use this tool unsafely or incorrectly, you can suffer serious personal injury.**

1. **Hold tool by insulated gripping surfaces when performing an operation where the cutting tool may contact hidden wiring.** Contact with a "live" wire will also make exposed metal parts of the tool "live" and shock the operator.
2. **Be aware that this tool is always in an operating condition, because it does not have to be plugged into an electrical outlet.**
3. **Wear ear protectors.**
4. **Check the socket carefully for wear, cracks or damage before installation.**
5. **Hold the tool firmly.**
6. **Always be sure you have a firm footing.**
7. **Be sure no one is below when using the tool in high locations.**
8. **The proper fastening torque may differ depending upon the kind or size of the bolt. Check the torque with a torque wrench.**

---

## SAVE THESE INSTRUCTIONS

**⚠ WARNING:**  
**MISUSE or failure to follow the safety rules stated in this instruction manual may cause serious personal injury.**

# SYMBOLS

USD302-1

The followings show the symbols used for tool.

V ..... volts

.../min..... revolutions or reciprocation per minute

⎓ ..... direct current

 ..... number of blow

n<sub>0</sub> ..... no load speed

# IMPORTANT SAFETY INSTRUCTIONS FOR CHARGER & BATTERY CARTRIDGE

USC001-3

1. **SAVE THESE INSTRUCTIONS** - This manual contains important safety and operating instructions for battery charger.
2. Before using battery charger, read all instructions and cautionary markings on (1) battery charger, (2) battery, and (3) product using battery.
3. **CAUTION** - To reduce risk of injury, charge only **MAKITA** rechargeable batteries marked on the charger label. Other types of batteries may burst causing personal injury and damage.
4. Do not expose charger to rain or snow.
5. Use of an attachment not recommended or sold by the battery charger manufacturer may result in a risk of fire, electric shock, or injury to persons.
6. To reduce risk of damage to electric plug and cord, pull by plug rather than cord when disconnecting charger.
7. Make sure cord is located so that it will not be stepped on, tripped over, or otherwise subjected to damage or stress.
8. An extension cord should not be used unless absolutely necessary. Use of improper extension cord could result in a risk of fire and electric shock. If extension cord must be used, make sure:
  - a. That pins on plug of extension cord are the same number, size, and shape as those of plug on charger;
  - b. That extension cord is properly wired and in good electrical condition;
  - c. That wire size is at least as large as the one specified in the table below.

Table 1: RECOMMENDED MINIMUM AWG SIZE FOR EXTENSION CORDS FOR BATTERY CHARGERS

Length of Cord (Feet)	25	50	100	150
AWG Size of Cord	18	18	18	16

9. Do not operate charger with damaged cord or plug - replace them immediately.
10. Do not operate charger if it has received a sharp blow, been dropped, or otherwise

- 
- damaged in any way; take it to a qualified serviceman.
11. Do not disassemble charger or battery cartridge; take it to a qualified serviceman when service or repair is required, Incorrect reassembly may result in a risk of electric shock or fire.
  12. To reduce risk of electric shock, unplug charger from outlet before attempting any maintenance or cleaning. Turning off controls will not reduce this risk.
  13. The battery charger is not intended for use by young children or infirm persons without supervision.
  14. Young children should be supervised to ensure that they do not play with the battery charger.
  15. If operating time has become excessively shorter, stop operating immediately. It may result in a risk of overheating, possible burns and even an explosion.
  16. If electrolyte gets into your eyes, rinse them out with clear water and seek medical attention right away. It may result in loss of your eyesight.

---

## ADDITIONAL SAFETY RULES FOR CHARGER & BATTERY CARTRIDGE

1. Do not charge Battery Cartridge when temperature is BELOW 10°C (50°F) or ABOVE 40°C (104°F).
2. Do not attempt to use a step-up transformer, an engine generator or DC power receptacle.
3. Do not allow anything to cover or clog the charger vents.
4. Always cover the battery terminals with the battery cover when the battery cartridge is not used.
5. Do not short the battery cartridge:
  - (1) Do not touch the terminals with any conductive material.
  - (2) Avoid storing battery cartridge in a container with other metal objects such as nails, coins, etc.
  - (3) Do not expose battery cartridge to water or rain.

A battery short can cause a large current flow, overheating, possible burns and even a breakdown.
6. Do not store the tool and Battery Cartridge in locations where the temperature may reach or exceed 50°C (122°F).
7. Do not incinerate the Battery Cartridge even if it is severely damaged or is completely worn out. The battery cartridge can explode in a fire.
8. Be careful not to drop, shake or strike battery.
9. Do not charge inside a box or container of any kind. The battery must be placed in a well ventilated area during charging.

---

## SAVE THESE INSTRUCTIONS

## FUNCTIONAL DESCRIPTION

### ⚠ CAUTION:

- Always be sure that the tool is switched off and the battery cartridge is removed before adjusting or checking function on the tool.

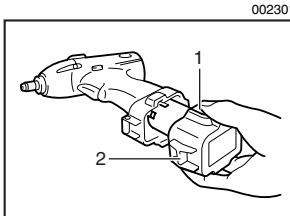

1. Button
2. Battery cartridge

### Installing or removing battery cartridge

- Always switch off the tool before insertion or removal of the battery cartridge.
- To remove the battery cartridge, withdraw it from the tool while pressing the buttons on both sides of the cartridge.
- To insert the battery cartridge, align the tongue on the battery cartridge with the groove in the housing and slip it into place. Always insert it all the way until it locks in place with a little click. If not, it may accidentally fall out of the tool, causing injury to you or someone around you.
- Do not use force when inserting the battery cartridge. If the cartridge does not slide in easily, it is not being inserted correctly.

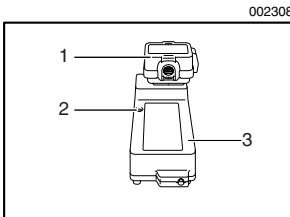

1. Battery cartridge
2. Charging light
3. Battery charger

### Charging

1. Plug the battery charger into the proper AC voltage source. The charging light will flash in green color.
2. Insert the battery cartridge so that the plus and minus terminals on the battery cartridge are on the same sides as their respective markings on the charger. Insert the cartridge fully into the port so that it rests on the charger port floor.
3. When the battery cartridge is inserted, the charging light color will change from green to red and charging will begin. The charging light will remain lit steadily during charging.
4. When the charging light color changes from red to green, the charging cycle is complete.
5. If you leave the battery cartridge in the charger after the charging cycle is complete, the charger will switch into its "trickle charge (maintenance charge)" mode which will last approximately 24 hours.
6. After charging, unplug the charger from the power source.

---

## **NOTE:**

- The battery charger is for charging Makita battery cartridge. Never use it for other purposes or for other manufacturer's batteries.
- When you charge a new battery cartridge or a battery cartridge which has not been used for a long period of time, it may not accept a full charge. This is a normal condition and does not indicate a problem. You can recharge the battery cartridge fully after discharging it completely and recharging a couple of times.
- If you charge a battery cartridge from a just operated tool or a battery cartridge which has been left in a location exposed to direct sunlight or heat for a long time, the charging light may flash in red color. If this occurs, wait for a while. Charging will begin after the battery cartridge cools. The battery cartridge will cool faster if you remove the battery cartridge from the battery charger.
- If the charging light flashes alternately in green and red color, charging is not possible. The terminals on the charger or battery cartridge are clogged with dust or the battery cartridge is worn out or damaged.

### **Trickle charge (Maintenance charge)**

If you leave the battery cartridge in the charger to prevent spontaneous discharging after full charge, the charger will switch into its "trickle charge (maintenance charge)" mode and keep the battery cartridge fresh and fully charged.

### **Tips for maintaining maximum battery life**

1. Charge the battery cartridge before completely discharged.  
Always stop tool operation and charge the battery cartridge when you notice less tool power.
2. Never recharge a fully charged battery cartridge.  
Overcharging shortens the battery service life.
3. Charge the battery cartridge with room temperature at 10°C - 40°C (50°F - 104°F).  
Let a hot battery cartridge cool down before charging it.
4. Charge the Nickel Metal Hydride battery cartridge when you do not use it for more than six months.



002317

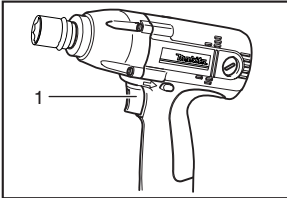

1. Switch trigger

## Switch action

### ⚠ CAUTION:

- Before inserting the battery cartridge into the tool, always check to see that the switch trigger actuates properly and returns to the “OFF” position when released.

To start the tool, simply pull the switch trigger. Tool speed is increased by increasing pressure on the switch trigger. Release the switch trigger to stop.

## Electric brake

This tool is equipped with an electric brake. If the tool consistently fails to quickly stop after switch trigger release, have tool serviced at a Makita service center.

002326

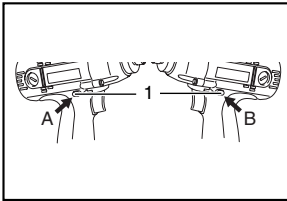

1. Reversing switch lever

## Reversing switch action

This tool has a reversing switch to change the direction of rotation. Depress the reversing switch lever from the A side for clockwise rotation or from the B side for counterclockwise rotation.

When the reversing switch lever is in the neutral position, the switch trigger cannot be pulled.

### ⚠ CAUTION:

- Always check the direction of rotation before operation.
- Use the reversing switch only after the tool comes to a complete stop. Changing the direction of rotation before the tool stops may damage the tool.
- When not operating the tool, always set the reversing switch lever to the neutral position.

## ASSEMBLY

### ⚠ CAUTION:

- Always be sure that the tool is switched off and the battery cartridge is removed before carrying out any work on the tool.

## Selecting correct socket

Always use the correct size socket for bolts and nuts. An incorrect size socket will result in inaccurate and inconsistent fastening torque and/or damage to the bolt or nut.

002341

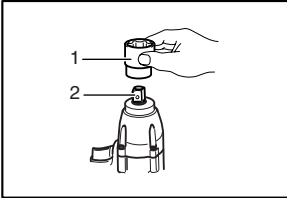

1. Socket
2. Anvil

## Installing or removing socket

To install the socket, push it onto the anvil of the tool until it locks into place.

To remove the socket, simply pull it off.

002344

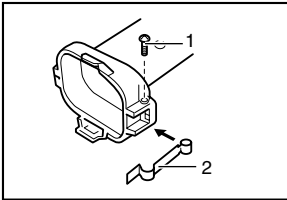

1. Screw
2. Set plate

## Installing set plate (optional accessory)

Always install the set plate when using battery cartridges 9100, 9102, 9101A. Install the set plate on the tool with the screw provided.

## OPERATION

002359

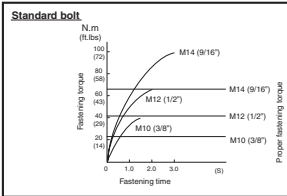

The proper fastening torque may differ depending upon the kind or size of the bolt, the material of the workpiece to be fastened, etc. The relation between fastening torque and fastening time is shown in the figures.

Hold the tool firmly and place the socket over the bolt or nut. Turn the tool on and fasten for the proper fastening time.

### NOTE:

- When fastening screw M8 (5/16") or smaller, carefully adjust pressure on the switch trigger so that the screw is not damaged.
- Hold the tool pointed straight at the bolt or nut.
- Excessive fastening torque may damage the bolt/nut or socket. Before starting your job, always perform a test operation to determine the proper fastening time for your bolt or nut. Especially for the bolt smaller than M8 (5/16"), perform the above test operation to prevent the trouble on socket or bolt, etc.

002360

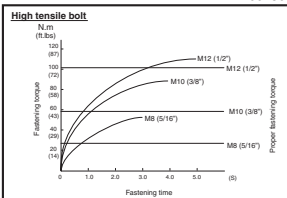

- If the tool is operated continuously until the battery cartridge has discharged, allow the tool to rest for 15 minutes before proceeding with a fresh battery.

The fastening torque is affected by a wide variety of factors including the following. After fastening, always check the torque with a torque wrench.

1. When the battery cartridge is discharged almost completely, voltage will drop and the fastening torque will be reduced.
2. Socket
  - Failure to use the correct size socket will cause a reduction in the fastening torque.
  - A worn socket ( wear on the hex end or square end ) will cause a reduction in the fastening torque.
3. Bolt
  - Even though the torque coefficient and the class of bolt are the same, the proper fastening torque will differ according to the diameter of bolt.
  - Even though the diameters of bolts are the same, the proper fastening torque will differ according to the torque coefficient, the class of bolt and the bolt length.
4. The manner of holding the tool or the material of driving position to be fastened will affect the torque.
5. Operating the tool at low speed will cause a reduction in the fastening torque.

## MAINTENANCE

### ⚠ CAUTION:

- Always be sure that the tool is switched off and the battery cartridge is removed before attempting to perform inspection or maintenance.

### Replacing carbon brushes

Remove and check the carbon brushes regularly. Replace when they wear down to the limit mark. Keep the carbon brushes clean and free to slip in the holders. Both carbon brushes should be replaced at the same time. Use only identical carbon brushes.

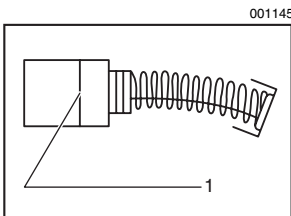

1. Limit mark

002376

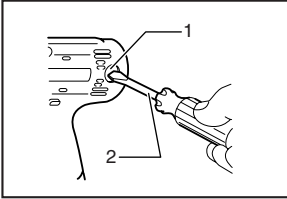

1. Brush holder cap
2. Screwdriver

Use a screwdriver to remove the brush holder caps. Take out the worn carbon brushes, insert the new ones and secure the brush holder caps.

After replacing brushes, insert the battery cartridge into the tool and break in brushes by running tool with no load for about 1 minute. Then check the tool while running and electric brake operation when releasing the switch trigger. If electric brake is not working well, ask your local Makita service center for repair.

To maintain product SAFETY and RELIABILITY, repairs, any other maintenance or adjustment should be performed by Makita Authorized or Factory Service Centers, always using Makita replacement parts.

EN0001-1

### Recycling the Battery

The only way to dispose of a Makita battery is to recycle it. The law prohibits any other method of disposal.

To recycle the battery:

1. Remove the battery from the tool.
2. a) Take the battery to your nearest Makita Factory Service Center  
or  
b) Take the battery to your nearest Makita Authorized Service Center or Distributor that has been designated as a Makita battery recycling location.

*Call your nearest Makita Service Center or Distributor to determine the location that provides Makita battery recycling. See your local Yellow Pages under "Tools-Electric".*

## ACCESSORIES

### ⚠ CAUTION:

- These accessories or attachments are recommended for use with your Makita tool specified in this manual. The use of any other accessories or attachments might present a risk of injury to persons. Only use accessory or attachment for its stated purpose.

If you need any assistance for more details regarding these accessories, ask your local Makita service center.

- Various type of Makita genuine batteries and chargers
- Set plate
- Shoulder strap
- Plastic carrying case

Cut



First-Class  
Postage  
Required

Post Office will  
not deliver  
without proper  
postage.

**Makita U.S.A., Inc.**  
14930 Northam Street  
La Mirada, CA 90638-5753



Fold

# MAIL THIS PORTION

Your answers to the following questions are appreciated.

**1. This product was purchased from:**

- Home Center       Other (                    )
- Hardware/Lumber Store
- Tool Distributor
- Industrial Supply
- Construction Supply

**3. How did you learn about this product:**

- Magazine       Radio
- From Dealer       Exhibition
- Newspaper       From Friend
- Store Display       Previous Usage
- Catalog       Other (                    )

**2. Use of the product is intended for:**

- Construction Trade
- Industrial Maintenance
- Home Maintenance
- Hobby
- Other (                    )

**4. Most favored points are:**

- Design       Repair Service
- Features       Durability
- Size       Power
- Price       Other (                    )
- Makita Brand

**5. Any comments:**

---



---



---



---

DATE PURCHASED				MODEL NO.						
MONTH		DAY		YEAR		SERIAL NO.				
<input type="text"/>	<input type="text"/>	<input type="text"/>	<input type="text"/>	<input type="text"/>	<input type="text"/>					
INTL.	LAST NAME / COMPANY NAME						STATUS		SEX	
<input type="text"/>	<input type="text"/>	<input type="text"/>	<input type="text"/>	<input type="text"/>	<input type="text"/>	<input type="text"/>	Married	Single	M	F
STREET ADDRESS										
CITY										
STATE		ZIP CODE				PHONE			AREA CODE	
<input type="text"/>	<input type="text"/>	<input type="text"/>	<input type="text"/>	<input type="text"/>	<input type="text"/>	<input type="text"/>	<input type="text"/>	<input type="text"/>	<input type="text"/>	<input type="text"/>
AGE:	<input type="checkbox"/> Under 19	<input type="checkbox"/> 20-29	<input type="checkbox"/> 30-39	<input type="checkbox"/> 40-49	<input type="checkbox"/> 50-60	<input type="checkbox"/> Over 60				

BE SURE TO COMPLETE THE CUSTOMER'S PORTION OF THIS FORM AND RETAIN FOR YOUR RECORDS.

Please return this portion by facsimile or mail.

Facsimile No: (714) 522-8133

# FACTORY SERVICE CENTERS

1-800-4-MAKITA

RETAIN THIS PORTION FOR YOUR RECORDS

## ALABAMA

2365 Pelham Parkway  
Pelham, AL 35124  
(205) 620-1791

## ARIZONA

3707 E. Broadway Rd., Ste. 6  
Phoenix, AZ 85040  
(602) 437-2850

## ARKANSAS

Shackelford Shopping Center  
240 South Shackelford Rd.,  
Ste. C  
Little Rock, AR 72211  
(501) 224-5733

## CALIFORNIA

41850 Christy St.  
Fremont, CA 94538-5107  
(510) 657-9881

1421 N. Clovis Ave., Ste. 112  
Fresno, CA 93727  
(559) 252-5166

14930 Northam St.  
La Mirada, CA 90638-5753  
(714) 522-9089

1970 Fulton Avenue  
Sacramento, CA 95825  
(916) 482-5197

1440 South "E" Street  
San Bernardino, CA 92408  
(909) 885-1289

7674 Clairemont Mesa Blvd.  
San Diego, CA 92111  
(858) 278-4471

1714 E. McFadden Ave., Unit M  
Santa Ana, CA 92705  
(714) 667-5066

1565 Winchester B.  
Campbell, CA 95008-0501  
(408) 379-0377

16735 Satcoy St., Ste. 105  
Van Nuys, CA 91406  
(818) 782-2440

## COLORADO

11839 E. 51st Ave.  
Denver, CO 80239-2709  
(303) 371-2850

## CONNECTICUT

508 Spring St.  
Windsor Locks, CT 06096  
(860) 292-6405

## FLORIDA

620 Douglas Ave. Suite 1302  
Altamonte Springs, FL 32714  
(407) 774-6000

750 East Sample Road  
Pompano Beach, FL 33064  
(954) 781-6333

Thompson Center Waters  
5501 W. Waters Ave., Ste. 406  
Tampa, FL 33634  
(813) 886-8292

## GEORGIA

4680 River Green Parkway  
Duluth, GA 30096-2566  
(770) 476-8111

## HAWAII

4510 Salt Lake Blvd., Suite A7  
Honolulu, HI 96818  
(808) 847-0038

## ILLINOIS

1450 Feehanville Dr.  
Mt. Prospect, IL 60056-6011  
(847) 297-3100

## INDIANA

8403 Michigan Road, Unit 1  
Indianapolis, IN 46268  
(317) 334-9980

## KANSAS

8819 W. 95th St.  
Overland Park, KS 66212  
(913) 642-1111

## KENTUCKY

1215 S. Hurstbourne Parkway  
Louisville, KY 40222  
(502) 326-3740

## LOUISIANA

5626 Jefferson Hwy.  
Harahan, LA 70123  
(504) 733-4138

## MARYLAND

7541 - 45 Ritchie Highway  
Glen Burnie, MD 21061  
(410) 590-0160

## MASSACHUSETTS

232 Providence Hwy.  
Westwood, MA 02090  
(617) 461-9754

## MICHIGAN

37454 Ann Arbor Trail  
Livonia, MI 48150  
(313) 432-1012

## MINNESOTA

6427 Penn Ave. South  
Richfield, MN 55423  
(612) 869-5199

## MISSOURI

9876 Watson Road  
St. Louis, MO 63126-2221  
(314) 909-9889

## NEBRASKA

4129 S. 84th St.  
Omaha, NE 68127  
(402) 597-2925

## NEVADA

3375 S. Decatur Blvd.  
Suite 22 - 24  
Las Vegas, NV 89102  
(702) 368-4277

## NEW JERSEY

251 Herrod Blvd.  
Dayton, NJ 08810-1539  
(609) 655-1212

## NEW MEXICO

5805 Menaul Blvd. NE  
Albuquerque, NM 87110  
(505) 881-4619

## NEW YORK

4917 Genesee Street  
Cheektowaga, NY 14225  
(716) 685-9503

131-35 31st Ave.  
Flushing, NY 11354  
(718) 866-0971

## NORTH CAROLINA

3501-G S. Tryon St.  
Charlotte, NC 28217  
(704) 527-0611

## OHIO

6253 E. Main St.  
Columbus, OH 43213  
(614) 860-0222

6379 Pearl Road  
Parma Heights, OH 44130  
(440) 843-7555

1617 E. Kemper Rd.  
Sharonville, OH 45246  
(513) 771-0788

## OKLAHOMA

552 E. Memorial Road  
Oklahoma City, OK 73114  
(405) 252-2655

## OREGON

828 19th Avenue, N.W.  
Portland, OR 97209  
(503) 222-1823

## PENNSYLVANIA

Springwater Plaza  
364 Wilmington W. Chester  
Pike  
Glen Mills, PA 19342  
(610) 459-4122

6200 Babcock Blvd  
Pittsburgh, PA 15237  
(412) 366-6363

## PUERTO RICO

200 Guayama St.  
Hato Rey, PR 00917  
(787) 250-8776

## TENNESSEE

4655 Nolensville Rd.  
Nashville, TN 37211  
(615) 331-9922

## TEXAS

12801 Stemmons Fwy Ste. 809  
Farmers Branch, TX 75234  
(972) 243-1150

12701 Directors Dr.  
Stafford, TX 77477-3701  
(281) 955-8665

3453 IH-35 North, Ste. 101  
San Antonio, TX 78219  
(210) 228-0676

## UTAH

145 E. 1300 S., Ste. 101  
Salt Lake City, UT 84115  
(801) 359-3410

## VIRGINIA

5760 Northampton Blvd., Ste.  
102  
Virginia Beach, VA 23455  
(757) 460-0280

## WASHINGTON

22220 84th Ave. So., Bldg. A  
Kent, WA 98032  
(253) 395-8055

## WISCONSIN

Lincoln Plaza Shopping Ctr.  
2245 S. 108th St. West Allis, WI  
53227  
(414) 541-4776

## CUSTOMER'S RECORD

<p><b>When you need service:</b> Send complete tool (prepaid) to one of the Makita Factory Service Centers listed, or to an Authorized Makita Service Center. Be sure to attach a letter to the outside of the carton detailing the problem with your tool.</p>	Date Purchased
	Dealer's Name & Address
	Model No.
	Serial No.

# WARNING

Some dust created by power sanding, sawing, grinding, drilling, and other construction activities contains chemicals known to the State of California to cause cancer, birth defects or other reproductive harm. Some examples of these chemicals are:

- lead from lead-based paints,
- crystalline silica from bricks and cement and other masonry products, and
- arsenic and chromium from chemically-treated lumber.

Your risk from these exposures varies, depending on how often you do this type of work. To reduce your exposure to these chemicals: work in a well ventilated area, and work with approved safety equipment, such as those dust masks that are specially designed to filter out microscopic particles.

## MAKITA LIMITED ONE YEAR WARRANTY

### Warranty Policy

Every Makita tool is thoroughly inspected and tested before leaving the factory. It is warranted to be free of defects from workmanship and materials for the period of ONE YEAR from the date of original purchase. Should any trouble develop during this one-year period, return the COMPLETE tool, freight prepaid, to one of Makita's Factory or Authorized Service Centers. If inspection shows the trouble is caused by defective workmanship or material, Makita will repair (or at our option, replace) without charge.

This Warranty does not apply where:

- repairs have been made or attempted by others:
- repairs are required because of normal wear and tear:
- the tool has been abused, misused or improperly maintained:
- alterations have been made to the tool.

IN NO EVENT SHALL MAKITA BE LIABLE FOR ANY INDIRECT, INCIDENTAL OR CONSEQUENTIAL DAMAGES FROM THE SALE OR USE OF THE PRODUCT. THIS DISCLAIMER APPLIES BOTH DURING AND AFTER THE TERM OF THIS WARRANTY.

MAKITA DISCLAIMS LIABILITY FOR ANY IMPLIED WARRANTIES, INCLUDING IMPLIED WARRANTIES OF "MERCHANTABILITY" AND "FITNESS FOR A SPECIFIC PURPOSE," AFTER THE ONE-YEAR TERM OF THIS WARRANTY.

This Warranty gives you specific legal rights, and you may also have other rights which vary from state to state. Some states do not allow the exclusion or limitation of incidental or consequential damages, so the above limitation or exclusion may not apply to you. Some states do not allow limitation on how long an implied warranty lasts, so the above limitation may not apply to you.

**Makita Corporation**  
3-11-8, Sumiyoshi-cho,  
Anjo, Aichi 446-8502 Japan



## Free Manuals Download Website

<http://myh66.com>

<http://usermanuals.us>

<http://www.somanuals.com>

<http://www.4manuals.cc>

<http://www.manual-lib.com>

<http://www.404manual.com>

<http://www.luxmanual.com>

<http://aubethermostatmanual.com>

Golf course search by state

<http://golfingnear.com>

Email search by domain

<http://emailbydomain.com>

Auto manuals search

<http://auto.somanuals.com>

TV manuals search

<http://tv.somanuals.com>